

Met**STREAM** 100

User Manual

GILL

Data Solutions Platform

(Parts 1955-100-0X-XX)

Doc No: 1955-PS-0001

Issue 5

Applies to MetStream units with Firmware 2499 v2.2.0 and onwards.



Gill Instruments Limited
Saltmarsh Park, 67 Gosport Street, Lymington,
Hampshire, SO41 9EG, UK
Tel: +44 1590 613500, Fax: +44 1590 613555
Email: anem@gillinstruments.com Website: www.gillinstruments.com

Contents

1.	FOREWORD.....	3
2.	INTRODUCTION.....	3
3.	SPECIFICATION	4
4.	PRE-INSTALLATION	6
4.1	Equipment supplied	6
4.2	MetStream 100 Part Numbers.	6
4.3	Packaging.....	7
4.4	Installation requirements.....	7
	4.4.1 Host system	7
	4.4.2 Software.....	7
	4.4.3 Cables.....	7
	4.4.4 Mounting.....	8
4.5	MetStream Connections.	8
	4.5.1 MetStream Front Panel Connectors.....	8
	4.5.2 Front Panel Status LED's	8
	4.5.3 Front Panel USB 2.0 Port	8
	4.5.4 MetStream Rear Panel Connectors.....	9
	4.5.5 Rear Panel Power Socket	9
	4.5.6 Rear Panel Ethernet Socket.....	9
	4.5.7 RS232/422/485 Connector	10
	4.5.8 Power Enable Function	10
5.	INSTALLATION.....	11
5.1	Installation Guidelines.....	11
	5.1.1 MetPak/MaxiMet to MetStream Data Input Connection	11
	5.1.2 Ethernet to Ethernet Connection	12
	5.1.3 Cable length.....	13
	5.1.4 Ethernet Socket Cable Wiring	13
	5.1.5 Power supplies	14
	5.1.6 Power over Ethernet Connection.....	14
5.2	Connections.....	14
	5.2.1 MetPak to MetStream RS232 Digital Input Connections.....	15
	5.2.2 MetPak to MetStream RS422 Digital Input Connections.....	15
	5.2.4 MaxiMet to MetStream RS232 Digital Input Connections	16
	5.2.5 MaxiMet to MetStream RS422 Digital Input Connections	16
	5.2.6 Mechanical installation.....	17
5.3	MetStream External Protection Box - Part 1955-PK-052.....	18
6.	METSTREAM GRAPHICAL USER INTERFACE.....	20
6.1	View MetStream GUI with a PC and Ethernet Crossover Cable.....	20
	6.1.1 PC/Laptop Set Up using Gill MScan Software.	20
	6.1.2 PC/Laptop Set Up if Gill MScan Software is not available.	22
6.2	Accessing the MetStream GUI using a PC and a Wi-Fi Router	24
6.3	Accessing the MetStream GUI using a PC and a LAN Port.....	27
6.4	MetStream Front Page GUI Features.	29
	6.4.1 Open Browser Window	29
	6.4.2 Dashboards	29
	6.4.3 Trend Graphs.....	31
	6.4.4 Change Reading Measurement Type, Gauge Range and Reset Max/Min.....	32
6.5	MetStream Configuration (Administrator Use).....	33
	6.5.1 Login	33
	6.5.2 Exit/Reboot/Shutdown/Thru Mode/Logout	34
	6.5.3 Username and Password	35
	6.5.4 Input Device Settings.....	36

6.5.5	Dashboard Settings (Administrator Use)	41
6.5.6	Measurement Log	42
6.5.7	Network Settings	45
6.5.8	Weather Observation Website (WOW)	47
6.5.9	Weather Underground	48
6.5.10	Date and Time	49
6.5.11	About	50
6.5.12	Thru Mode (Diagnostic Connection)	51
6.5.13	Port Forwarding	56
7.	MAINTENANCE & FAULT-FINDING	57
7.1	Maintenance	57
7.2	Fault-finding	58
7.3	Returning Units	59
8.	APPENDICES	59
8.1	Glossary & Abbreviations	59
8.2	Guarantee	60
9.	FCC	60

1. FOREWORD

Thank you for purchasing the MetStream 100 manufactured by Gill Instruments Limited. To achieve optimum performance we recommend that you read the whole of this manual before proceeding with use.

Gill products are in continuous development and therefore specifications may be subject to change and design improvements without prior notice.

The information contained in this manual remains the property of Gill Instruments and should not be copied or reproduced for commercial gain.

2. INTRODUCTION

The Gill MetStream 100 is a robust unit which allows automatic detection of a connected Gill Instruments MetPak or MaxiMet Range Weather Station to its Digital input and with the use of its Ethernet Output allow Weather Data to be viewed and logged over a PC network.

Comma Separated serial data RS232/422 Wind Sensors and Instruments can be set up to work manually with MetStream in order to view and log their data.

The MetStream 100 can be used in conjunction with a Wireless Router, LAN or PC.

After you have successfully set up the MetStream 100, we strongly advise that you then go back and read the rest of the manual to ensure that you get the best results from the MetStream 100.

3. SPECIFICATION

MetStream 100 - Parts 1955-100-0X-XX

Input Power Requirement (MetStream only)

Voltage	9-30V DC
Current	145mA max @12V DC (2W) MetStream only 500mA max @ 12V DC, (6W max) including external sensor

Power over Ethernet

Built-in receiver (IEEE 802.3af-2003)

Output Power

Voltage	Regulated 12V DC \pm 10%
Current	Up to 300mA @ 12V DC

Digital Input

Communication	ASCII, RS232, RS422/485 4 wire, full duplex
Baud rates	1200, 2400, 4800, 9600, 19200, 38400, 57600
Formats	8 data, odd, even or no parity
Data Input Rate	Up to 32Hz

Digital Output

Format	8P8C
Communication	Ethernet 10/100 BASE-T speeds/format

Internal Storage

Micro SD Card	8GB card for logged data.
---------------	---------------------------

External Data Storage

USB 2.0 Port	Expansion port supplied for external USB Data Storage, max of 32GB supported.
--------------	---

Start Up Time

Data Ready	Less than 90 seconds (MetStream box) from power up.
------------	---

Dimensions

Size	112mm long, 111mm wide, 34mm deep.
Weight	0.27kg.

Materials

External Construction	Aluminium and Plastic
-----------------------	-----------------------

Environmental

Moisture protection	IP40 IP65 with optional Gill outdoor enclosure
Operating temperature	-20°C to +70°C
Storage temperature	-40°C to +80°C
Humidity	<5% to 95% RH
EMC	BS EN 55024:2010 BS EN 55022:2010
FCC	CFR47 Part 15B

Standards

Traceable to UK national standards

MetStream Power Supply Unit - Part 026-04969

(Supplied with all MetStream Parts 1955-100-0X-XX)

Input Voltage Range	100v to 240V AC @ 300mA max (50/60Hz)
Mains Adaptors	UK, Euro, US and AUS types supplied.
Output Power	
Voltage	Regulated 12V DC \pm 2%
Current	Up to 1 Amp (over current and short circuit current protected).
DC Cord	1.5 metres long with right angled 2.1 C +ve plug.
Dimensions	
Size	79mm long x 55.4mm wide x 37mm deep.
Weight	150 grams.
Materials	
External Construction	Plastic, PB free ROHS compliant.
Environmental	
Operating temperature	0°C to +40°C
Storage temperature	-20°C to +60°C
Humidity	5% to 95% RH
EMC	BS EN 55024:2010 BS EN 55022:2010
FCC	CFR47 Part 15B
EMI	BS EN55022 FCC (Part 15 Class B)
SAFETY	UL60950-1

MetStream External Protection Box - Part 1955-PK-052

(Supplied with MetStream Part 1955-100-02-XX)

Dimensions	
Size	335mm long x 220mm wide x 107mm deep.
Weight	1.5kg
Maximum Cable size	5 x 2.5 mm sq.
Materials	
External Construction	Thermoplastic.
Environmental	
Moisture protection	IP65
Install Temperature	0°C to +40°C
Operating temperature	-20°C to +70°C

4. PRE-INSTALLATION

4.1 Equipment supplied

MetStream 100.

Universal Ac supply input, 12v dc 1A output supply.

2 Metre one to one Ethernet lead.

1 Metre crossover Ethernet lead.

Terminal block 8-way connector.

DC Input Power Plug 2.1mm.

4.2 MetStream 100 Part Numbers.

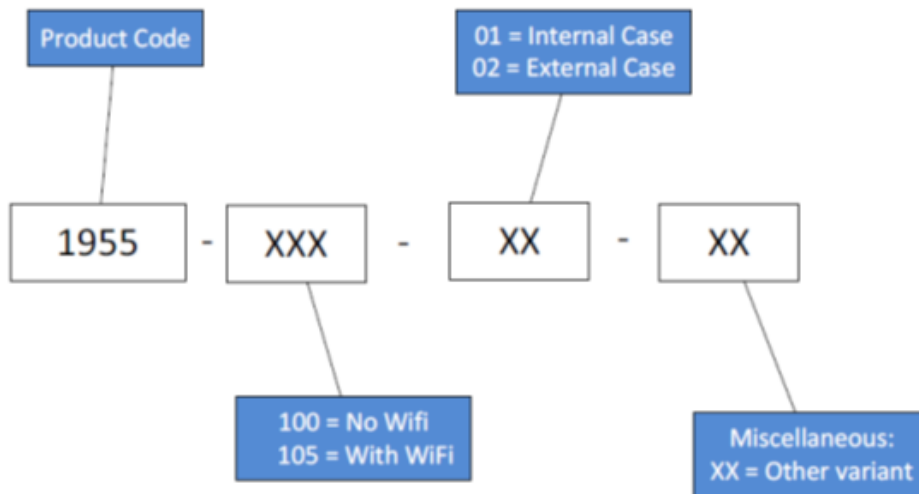

Available spare parts and optional extras are as detailed below:-

Item	Part Number
MetStream 100 (Supplied unit).	1955-100-0X-XX
Mains powered 12v dc Power Supply (Supplied with MetStream).	026-04969
Ethernet Cable (one to one) 2 Metres long (Supplied with MetStream).	026-04970
Ethernet Crossover cable 1 Metre long (Supplied with MetStream).	026-05073
8 way Spring terminal block (Supplied with MetStream).	020-04277
External Protection Box (Supplied with part 1955-100-02-XX).	1955-PK-052
DC Input Power Plug (2.1mm) (Supplied with MetStream)	020-05134

4.3 Packaging

Whilst the MetStream 100 is being moved to its installation site, the unit should be kept in its packaging. Retain the packaging for use if the unit has to be moved or returned to Gill Instruments.

4.4 Installation requirements

4.4.1 Host system

Select from the following:

- Router with Ethernet input. Or
- Wi Fi Modem with Ethernet input. Or.
- LAN Ethernet input.
- Plus:-
- PC with Wi Fi or Ethernet input to view MetStream Data.
- Internet Browser (we recommend Firefox, Chrome or IE9.0 or later)
- Optional USB 2.0/3.0 data stick to export store logged data.
- Gill Instruments MetPak or MaxiMet Range Unit set for ASCII, RS232, and RS422 output (see <http://www.gillinstruments.com/products/anemometer/weather-station-range.htm> for the range of MetPak units or <http://gillinstruments.com/products/anemometer/maximet-compact-weather-stations.html> for MaxiMet units).

4.4.2 Software

- Gill MScan Software to detect the MetStream IP address.
 - Note MScan app works on Windows devices.

4.4.3 Cables

- **To connect MetStream to the host unit (e.g. MetStream 100 to a MetPak unit).**

Use a suitable RS232 or RS422/485 cable, there are restrictions on cable type and length for suitable operation, refer to the connecting equipment Manual.

- **To connect the MetStream 100 to an Ethernet port.**

Use a CAT 5, CAT5e or CAT 6 cable to connect between the MetStream 100 and the user interface equipment.

Ethernet cables of up to 100 metres can be supported.

A 2 Metre Ethernet test cable is supplied (non-crossover type).

- **To connect the MetStream 100 directly to a PC.**

Use a CAT 5, CAT5e or CAT 6 crossover cable to connect between the MetStream 100 and the PC Ethernet port.

Ethernet cables of up to 100 metres can be supported.

A 1 Metre Ethernet crossover test cable is supplied.

- **To connect DC power to the MetStream unit**

A 12v dc power supply and lead with wired connector are supplied otherwise use a cable suitable for connecting a dc supply of nominally 12v dc (1 amp recommended). If requiring full current then take into account volt drops if a long cable run is needed.

4.4.4 Mounting

- The MetStream 100 is designed for indoor use.
- The MetStream 100 can be positioned laid flat down or on its side.
- For outdoor use the unit should be enclosed in a box that provides the necessary sealing that will meet the outdoor climatic conditions. Gill instruments can provide an outdoor box if required part number 1955-PK-052.

4.5 MetStream Connections.

4.5.1 MetStream Front Panel Connectors

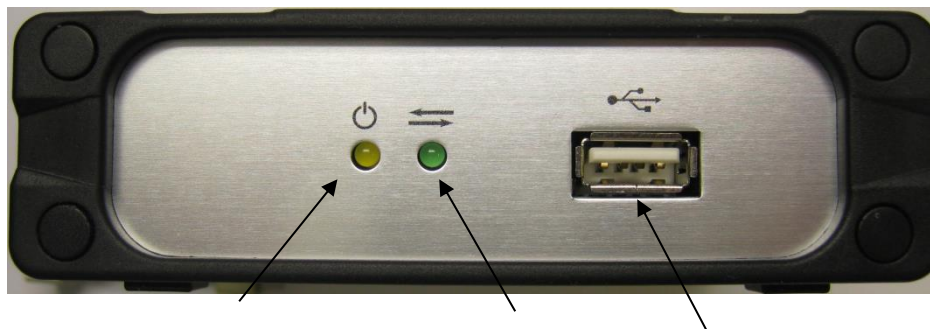

DC Power LED

Connection
Status LED

USB Port to
copy data

4.5.2 Front Panel Status LED's

The Yellow LED illuminated indicates DC Power is applied to the MetStream Box. The Green LED illuminated indicates unit connecting/connected to a user unit. A flashing Green LED means that MetStream is communicating with the connected instrument.

When power is applied to the MetStream with valid equipment wired to the RS232/422/485 connector the Green LED will be:-

- Off initially for approximately 10 seconds.
- On for approximately 20 seconds.
- Flash whilst correct communication (Comms Mode and Baud Rate) with the connected device is being established.
- On continuously when the connected instrument is recognised and data is ready to be read.

However allow up to 90 seconds for a valid connection to be established depending on equipment connected.

4.5.3 Front Panel USB 2.0 Port

Suitable for a USB data stick to copy files from MetStream.

Maximum 32GB device supported.

Hot Pluggable.

4.5.4 MetStream Rear Panel Connectors

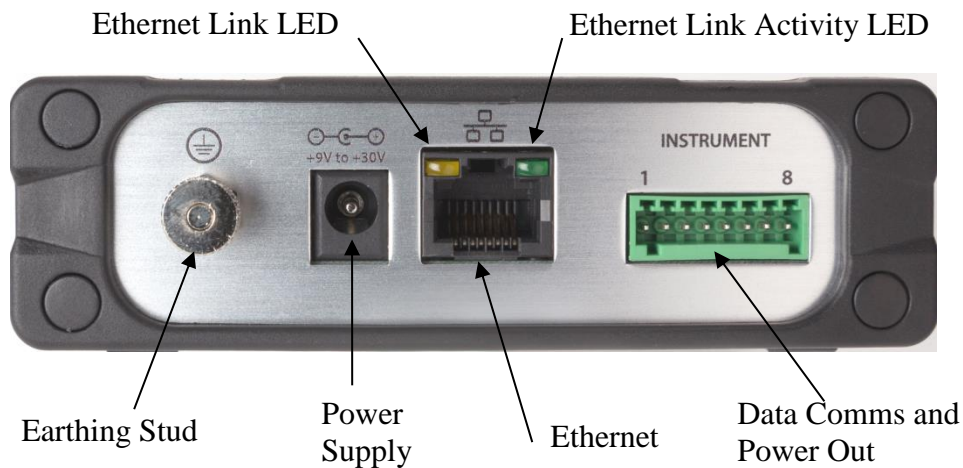

4.5.5 Rear Panel Power Socket

Two contact power socket Use with 2.1mm x 5.5mm plug (supplied, see below).
 Voltage Range 9v to 30v dc.
 Input Current Up to 145mA @ 12V from MetStream.
 Up to 0.5A @ 12V, MetStream and external device.

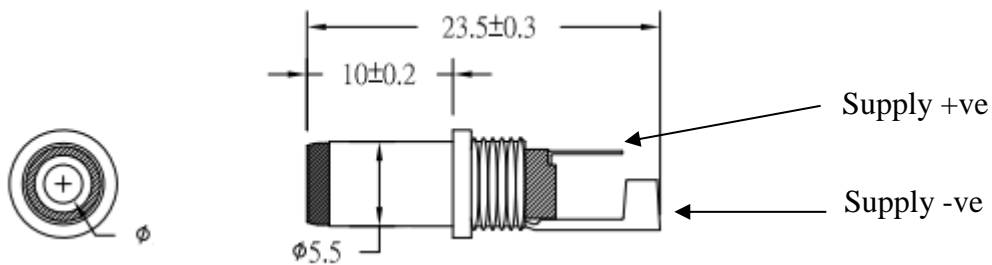

4.5.6 Rear Panel Ethernet Socket

A standard Ethernet socket is provided for connecting:-

The supplied 2 metre Ethernet cable for a Local Area Network (LAN) connection

Or

The 1 Metre Ethernet crossover cable for direct connection to a PC.

Other length Ethernet cables can be used:-

If there is a successful connection between the MetStream Ethernet socket and LAN then the Yellow Ethernet Socket LED's will be illuminated and the Green LED will indicate Data traffic activity.

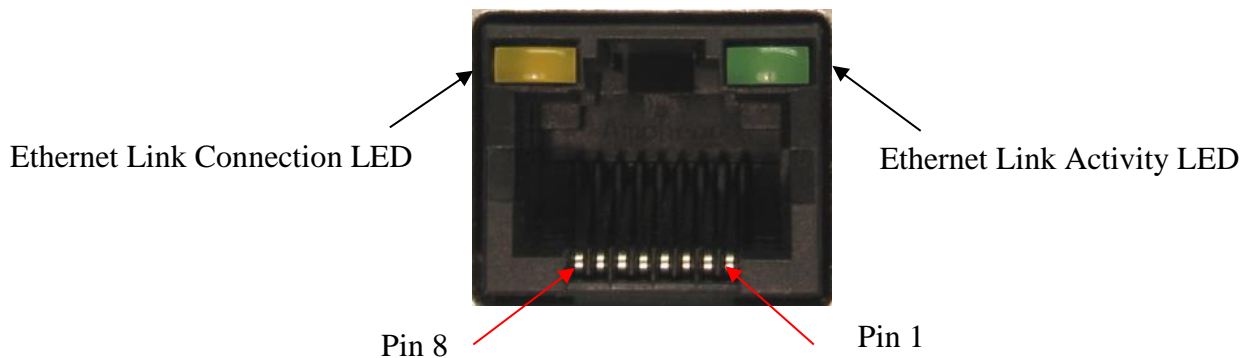

4.5.7 RS232/422/485 Connector

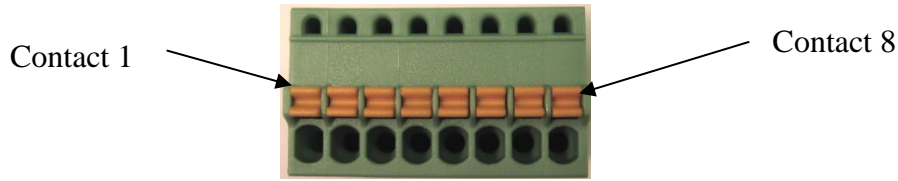

A removable 8 way plug is supplied for the RS232/422/485 data input connections. The part number for the plug is Phoenix Contact 8 way spring terminal Part 1881383 (supplied with MetStream).

Connections to the RS232/422/485 connector are

CONTACT/ COMMS MODE	1	2	3	4	5	6	7	8
RS232	Rx+-	-	-	Tx-	+12v dc Output	Power Enable	0v	0v
RS422/485	Rx+	Tx+	Rx-	Tx-	+12V dc Output	Power Enable	0v	0v

Recommended range of wire gauges that can be used with the connector is 20 AWG to 28 AWG.

Wires connected to this plug should be stripped back 8 mm for insertion into the push/lock connector.

NOTE: A similar 8 way plug is used on Gill MetPak units, refer to the appropriate MetPak manual for wiring to the 8 way connector as contact 1 to 8 number positions are not as above.

4.5.8 Power Enable Function

The +12v dc output is only enabled on Terminal 5 when the **Power Enable connection** on Terminal 6 is connected to Terminal 7 (0v) or Terminal 8 (0v).

If Terminal 6 **Power Enable** is left open circuit then the 12V supply output from Terminal 5, and any connected instrument using this supply, will be disabled.

In this case, the external instrument should be powered separately from the MetStream by a customer-provided supply.

5. INSTALLATION

NOTE: Warranty is void if the MetStream case is opened.

5.1 Installation Guidelines

- The MetStream 100 is designed for indoor use.
- For outdoor use a suitable sealed enclosure that meets the required environmental conditions can be used.
 - Gill instruments can supply an outdoor IP65 enclosure; refer to the technical specification in the front of this manual to ensure it meets the required conditions of use.
- Ensure the product is correctly earthed in accordance with this manual.
- Use cables recommended by Gill, keeping the length below the maximum allowed. Where the cables are cut and re-connected (junction boxes, plugs and sockets) the cable screen integrity where applicable must be maintained, to prevent the EMC performance being compromised.
- Earth loops should not be created – earth the system in accordance with the installation guidelines.
- Ensure the power supply operates to the MetStream 100 specification at all times.

Bench system test

Note: Prior to physically mounting the MetStream 100 in its final location, we strongly recommend that a bench system test be carried out to confirm the system is configured correctly, is fully functional and electrically compatible with the selected host system and cabling (preferably utilising the final cable length). The required data format, units and other options should also all be configured at this stage.

Ensure that any unit connected to the MetStream data input has been configured first for the required Communication protocol and baud rate.

5.1.1 MetPak/MaxiMet to MetStream Data Input Connection

The following table shows an example manufacturers' reference; other manufacturers' equivalents can be used.

Recommended Belden cable types

Application	No. of Pairs	Belden Ref.
Digital RS232	3	9503
Digital RS422	4	9504

For RS422 operation the cable should contain twisted pairs screened to match the application.

Cable length

The maximum cable length is dependent on the chosen communication method.

The following table shows the maximum cable lengths for the supported communication protocols at the given baud rates, using the recommended cable. If any problems of data corruption etc. are experienced, then a slower baud rate should be used. Alternatively, a higher specification cable can be tried.

Maximum cable lengths for supported communication networks

Communication format	Baud rate	Max. cable length
RS232	19200	6.5M
RS422	19200	1000M

Cabling (unused wires)

Any unused wires in the connecting cables should be connected to ground preferably at the user equipment end.

Cabling protection

Cables should be secured:-

With cable clamps or equivalent at regular intervals such that the hub box cable gland does not support the cable weight.

Away from any mounting bolts to prevent chaffing of the cable.

NOTE: Install appropriate strain relief support to the cable if required.

Earthing

To ensure correct operation and for maximum protection from lightning, a separate lightning rod system is recommended to protect the system.

You can also earth the MetStream through its mountings or by connecting a grounding cable to the MetStream Earth Terminal Post. Clean off any paint etc. that might prevent a good connection to the Earth structure.

When you connect the screened communications cable ensure that the screen has a connection to the MetStream Case.

5.1.2 Ethernet to Ethernet Connection

An Ethernet compatible cable should be used.

Generic description:-

2 Twisted pairs for Data only application.

4 twisted pairs for Data and Power over Ethernet (POE) applications.

CAT5 or higher RJ45.

8 pin 8 contact type (8P8C).

Max Cable Length 100 metres (Cat 5, Cat 5e, Cat 6).

Types - straight or crossover depending on system connection.

Shielded Twisted Pair (STP) recommended or Unshielded Twisted Pair (UTP).

The table below shows some set up cable options.

Cable type required for setup

	PC	Wi Fi Router	LAN
MetStream to:-	Crossover	Straight	Straight

5.1.3 Cable length

The typical maximum length at Ethernet 10Mbps data rate is 100 Metres, using the recommended cable.

If any problems of data corruption are experienced (due to, for example, a high local electrical ‘noise’ level), then check that a shielded Ethernet twisted pair cable is being used. Alternatively, a thicker or higher specification cable can be tried.

5.1.4 Ethernet Socket Cable Wiring

The rear Ethernet RJ45 socket on the MetStream unit has the following connections:-

10Base T Port Pin outs.

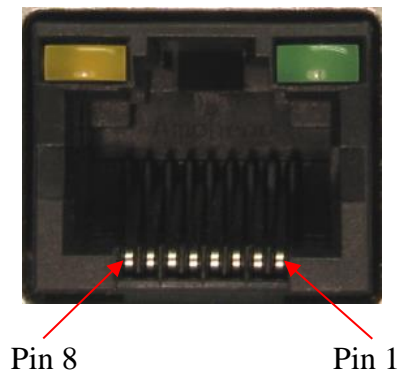

IEEE 802.3af connections using spare pairs for POE.

8 Pin ⁸	Description	TIA/EIA 568A	TIA/EIA 568B
1	Transmit+	White/Green	White/Orange
2	Transmit -	Green	Orange
3	Receive+	White/Orange	White/Green
4	DC+	Blue	Blue
5	DC+	White/Blue	White/Blue
6	Receive -	Orange	Green
7	DC-	White/Brown	White/Brown
8	DC-	Brown	Brown

Pins 4, 5, 7 and 8 are not used unless a Power over Ethernet connection is used. Ensure that a fully 8 wire populated cable is used for POE applications.

5.1.5 Power supplies

MetStream 100 units

Input Supply: -

Voltage	9v to 30v DC.
Current	145mA max@12v DC (excludes external USB flash drive and externally connected sensor).
Current	500mA max@12v DC including external Sensor.

5.1.6 Power over Ethernet Connection.

It is possible to Supply Power to a MetStream 100 and connected MetPak unit for instance through the use of a Single Port MidSpan PoE Injector.

Typically the Power over Ethernet device will inject 48v dc on the Ethernet cable to connect to the MetStream 100 unit.

Typical 48v current capacity should be 350mA.

Maximum cable length between The POE injector and MetStream should be 100 Metres
Connect MetStream Ethernet lead to the Power and Data connection socket.

Typical MetStream System Connection using Power over Ethernet.

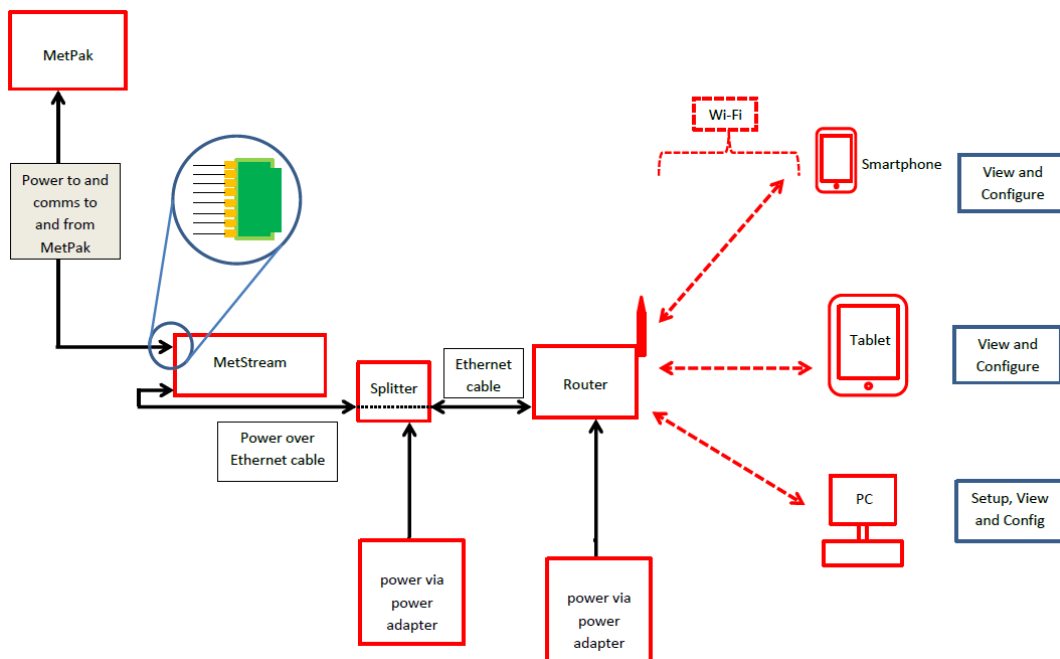

5.2 Connections

Important:- Any cable wires not used should be isolated and grounded at the terminating equipment/user end.

Digital OV should be used in conjunction with RS422 TX RX lines in order to improve noise immunity.

Earthing or grounding

It is recommended that MetStream metal case is grounded via its Knurled Screw Earth Terminal.

5.2.1 MetPak to MetStream RS232 Digital Input Connections

The following example shows a MetPak with its COMMS set for RS232 connected to MetStream. This is the MetPak default communication configuration setting.

NOTE: The 8 way connectors fitted to MetStream and MetPak are identical, take care when connecting the lead to the equipments to ensure that cable wiring matches that required of the connecting equipment.

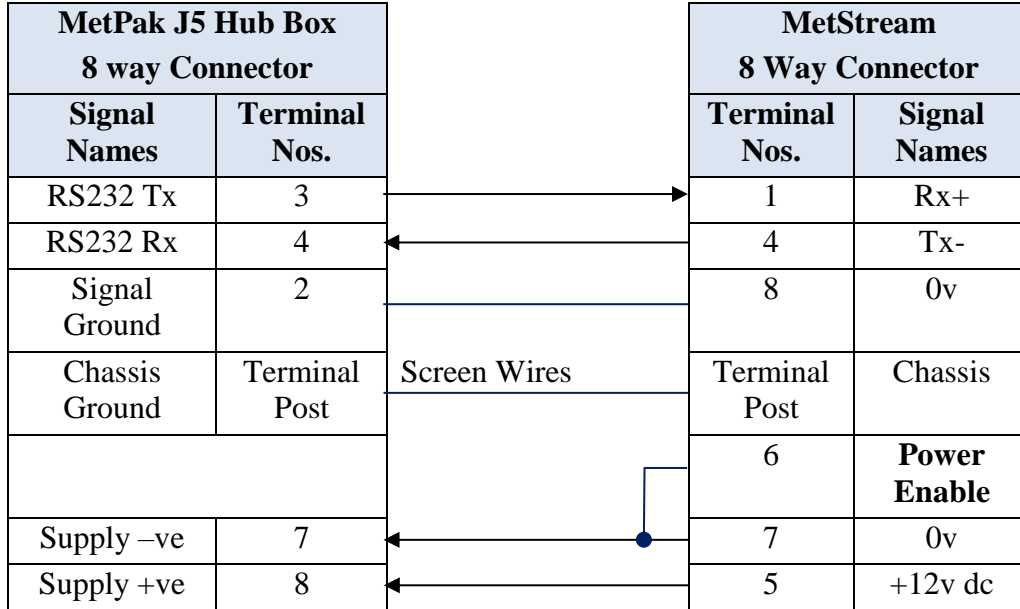

5.2.2 MetPak to MetStream RS422 Digital Input Connections

The following example shows a MetPak with its COMMS set for RS422 connected to MetStream. This is not the default MetPak communications setting; ensure the MetPak has been configured for this output requirement before wiring to MetStream.

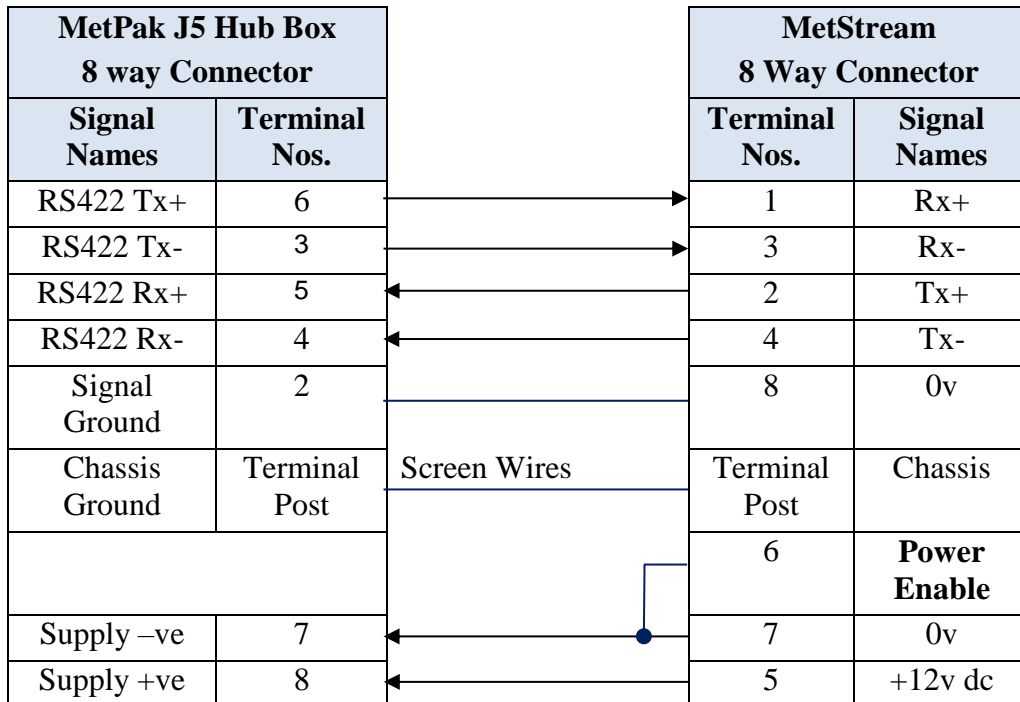

5.2.4 MaxiMet to MetStream RS232 Digital Input Connections

The following example shows a MaxiMet with its COMMS set for RS232 connected to MetStream. This is the MaxiMet default communication configuration setting.

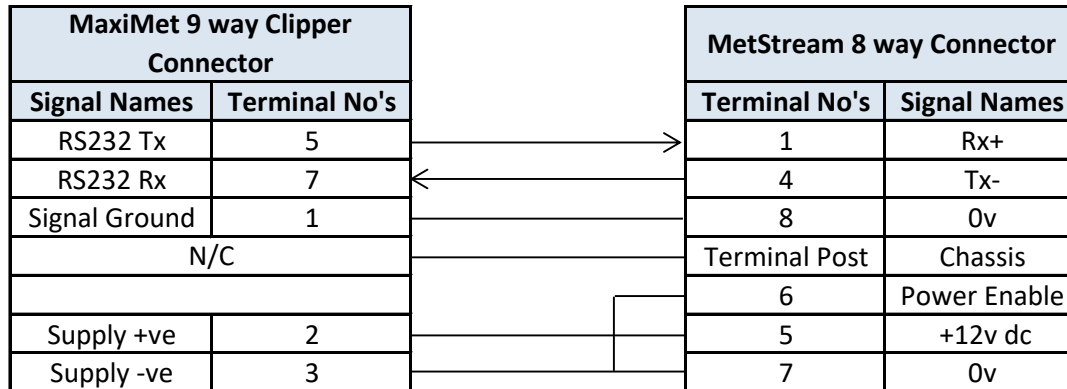

5.2.5 MaxiMet to MetStream RS422 Digital Input Connections

The following example shows a MaxiMet with its COMMS set for RS422 connected to MetStream. This is not the default MaxiMet communications setting; ensure the MaxiMet has been configured for this output requirement before wiring to MetStream

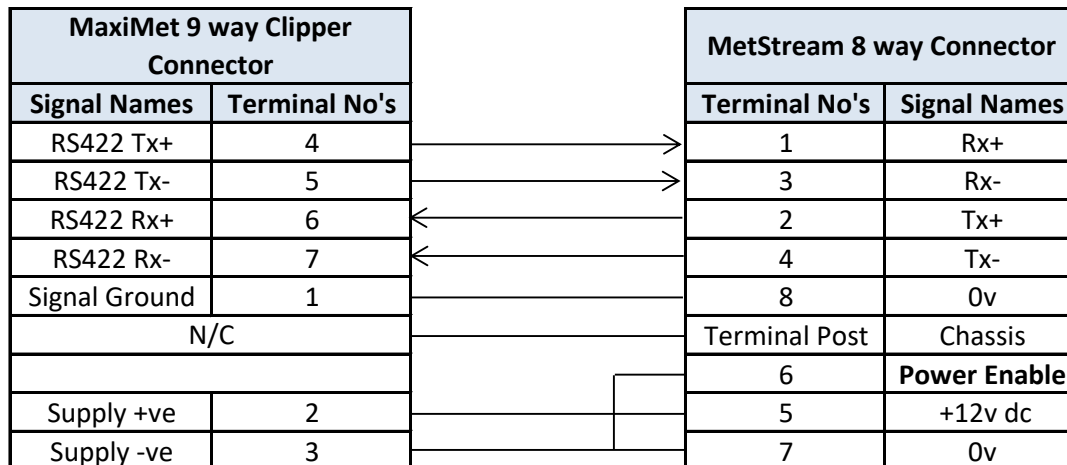

5.2.6 Mechanical installation

Before installing, a bench system test is recommended.

All the time the MetStream 100 is not in its final location, it should be protected from damage by keeping it in the original packaging as long as possible.

Location

It is advised to not site the MetStream 100 in close proximity of electrical noise, Radar or RF transmitters. A site survey may be required if there is any doubt about the strength of external electrical noise.

Orientation

The unit may be mounted in any orientation.

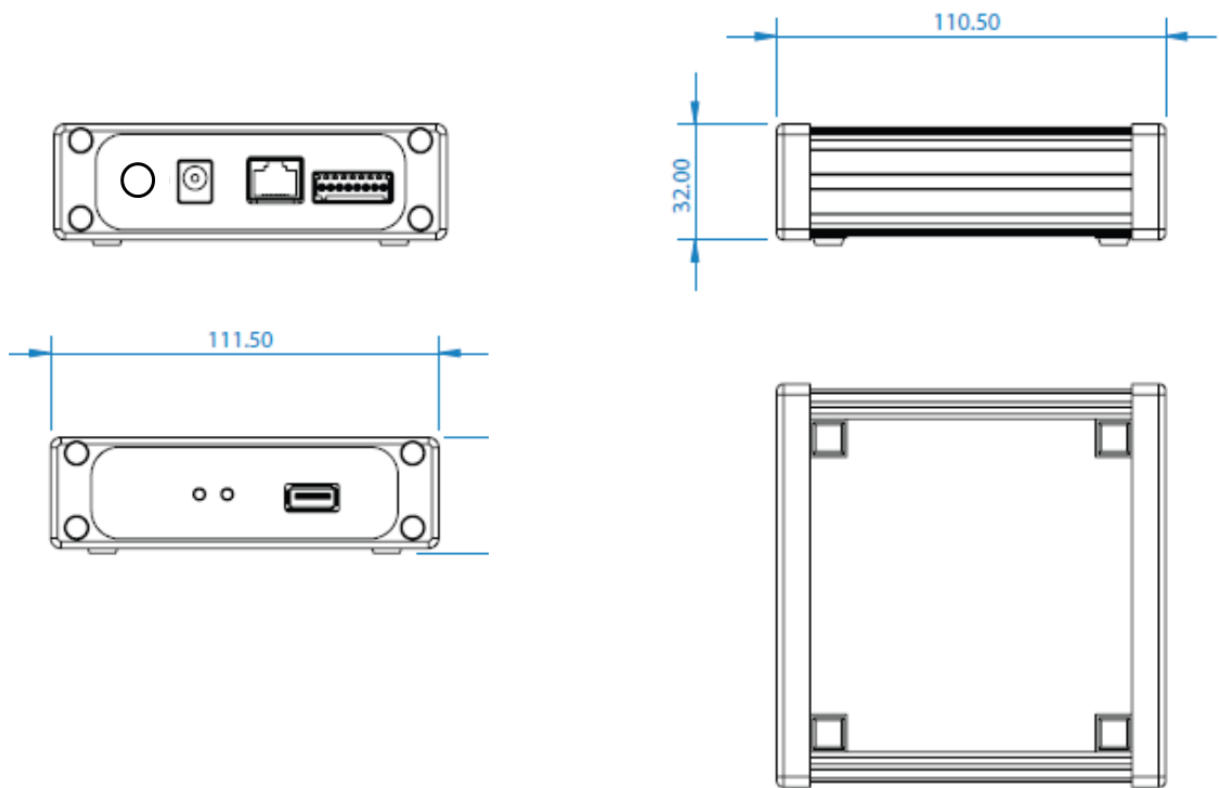

Dimensions are in mm

5.3 MetStream External Protection Box - Part 1955-PK-052

(Supplied with MetStream Part 1955-100-02-XX).

Note the environmental temperature conditions etc. under which the Protection Box and MetStream will be used to ensure there is no conflict (see manual Specification pages 4 and 5).

Outer Case Dimensions (with cover in place) 335mm long x 220mm wide x 107mm deep.

Case Preparation and Mounting

The case should be mounted on a vertical surface with cable entries at the bottom. The case should be mounted onto a flat surface to prevent twisting that could affect sealing.

Do not drill any holes in the enclosure apart for those for waterproof glands as this could impair on the IP65 weather proof rating.

A template (not to scale) is shown to aid mounting hole positioning (units in mm).

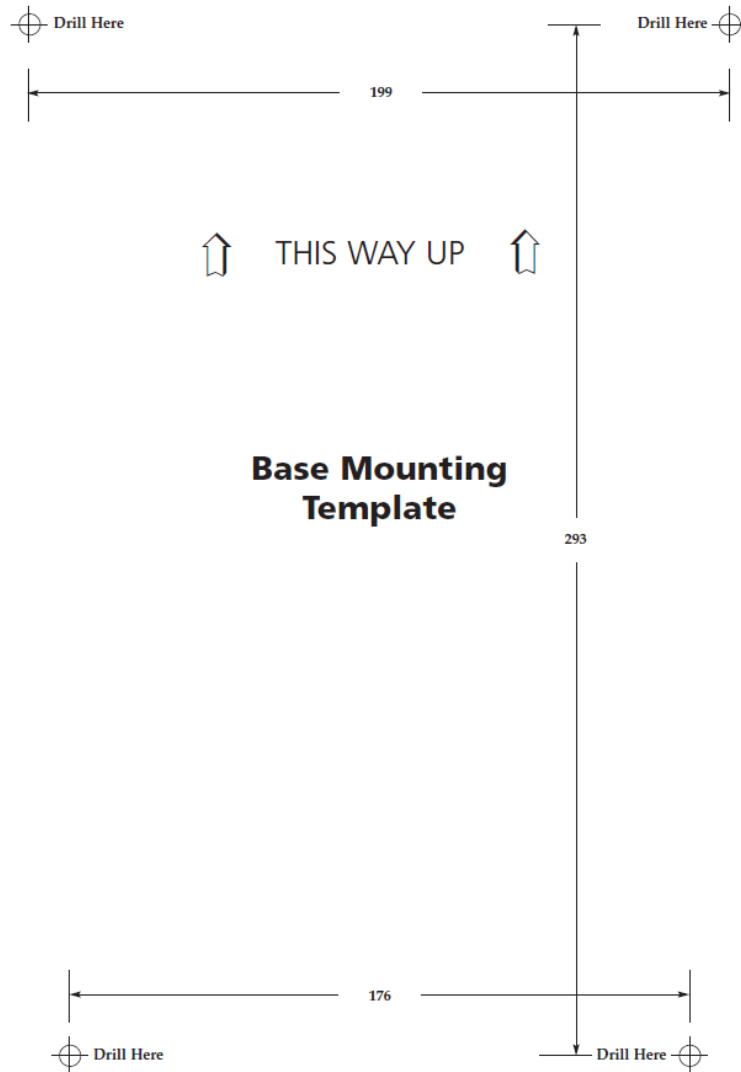

To install the MetStream unit loosen the 2 Philips screws identified below, slide the clamp plate to the right.

Slide in the MetStream unit as shown and clamp in MetStream and tighten the 2 screws.

Connect the supplied pre-wired Earth Tag, Power and 8 Way MetStream plugs to MetStream.

Installed cable connections are as follows:-

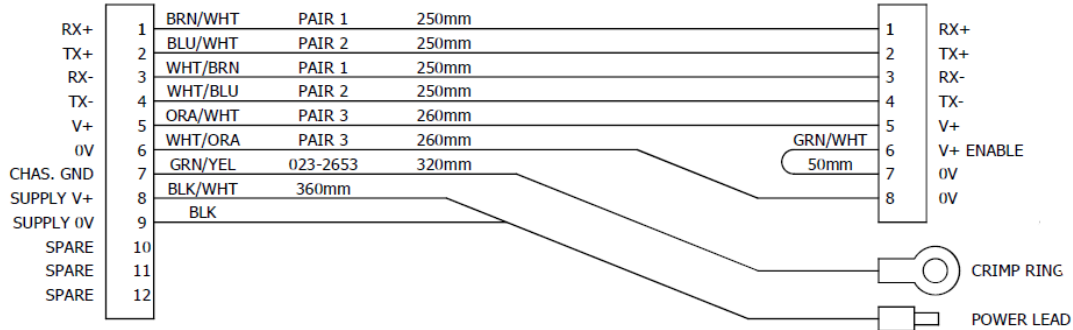

Connect external Power and Communications to the MetStream via the sealing strip or gland entry points and terminate in the 12 way screw fitting connector block.

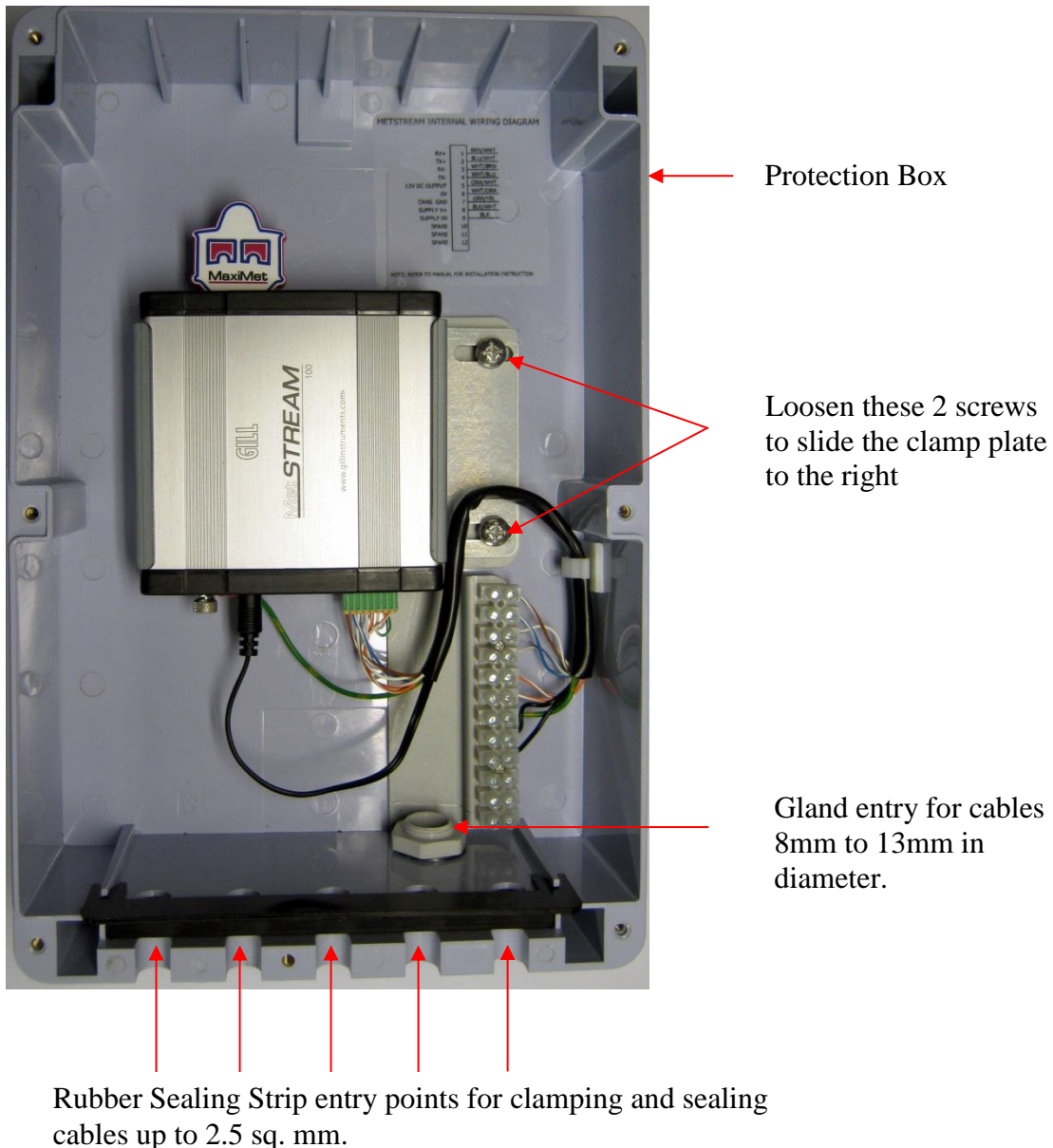

6. METSTREAM GRAPHICAL USER INTERFACE

The MetStream 100 output can be viewed in a Graphical User Interface (GUI) by connecting directly to a PC/Laptop or via a Wi Fi or Ethernet LAN connection and opening a Web Page (Internet Explorer 9 or Mozilla Firefox 19.0.2 are recommended, earlier versions may not be suitable). This then allows the user to view data and those with password access to retrieve logged data and change GUI settings.

Parts required:-

MetStream 100 and Power Supply (supplied).

Ethernet 1 Metre crossover cable (supplied).

Ethernet 2 Metre non crossover cable (supplied).

Gill MScan Software (available to download here:

<http://gillinstruments.com/main/software.html>).

Computer preferably running Internet Explorer version IE9 (Chrome) or Mozilla Firefox 19.0.2.

Gill MetPak or MaxiMet Range Unit or suitable connecting device (ensure configuration compatible with MetStream before connection).

6.1 View MetStream GUI with a PC and Ethernet Crossover Cable.

Connect equipment as per the following system diagram.

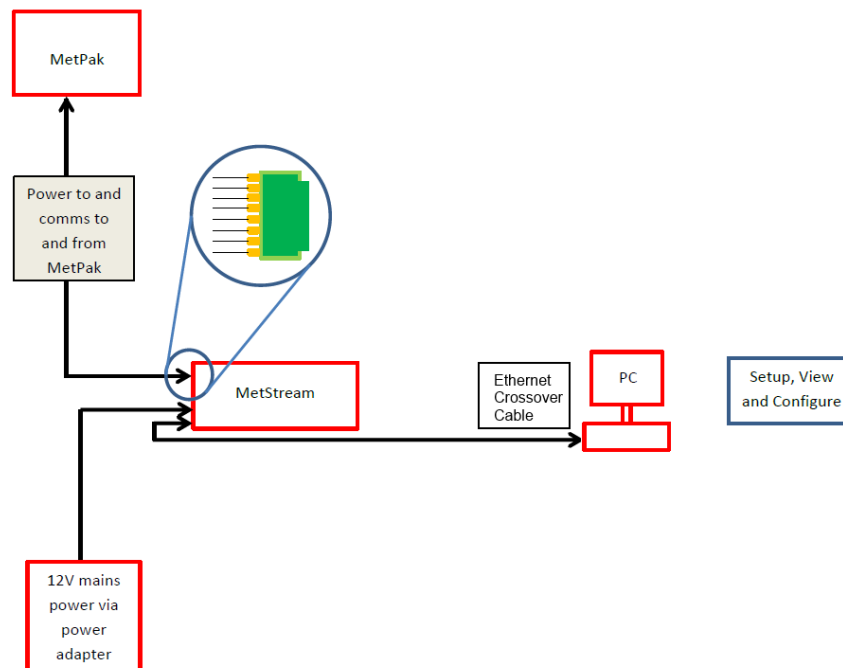

On first applying power to the MetStream 100, wait for 90 seconds before attempting to access it for data.

6.1.1 PC/Laptop Set Up using Gill MScan Software.

If the PC/laptop has a Wi Fi connection then you may need to temporarily disable this function to connect to MetStream via a direct Ethernet crossover cable connection.

Note: - It is recommended to connect the MetPak or connected device to MetStream to ensure correct configuration, however it is possible to set up MetStream parameters without the connected device.

Load and Open Gill MScan Software on to the PC.

Select 'Direct Connection between PC and MetStream'.

Click on the 'Find MetStream(s)' button.

A MetStream should be found at 192.168.67.67.

Click on MetStream found at 192.168.67.67 to highlight the MetStream IP Address.

Click on 'Connect to MetStream'.

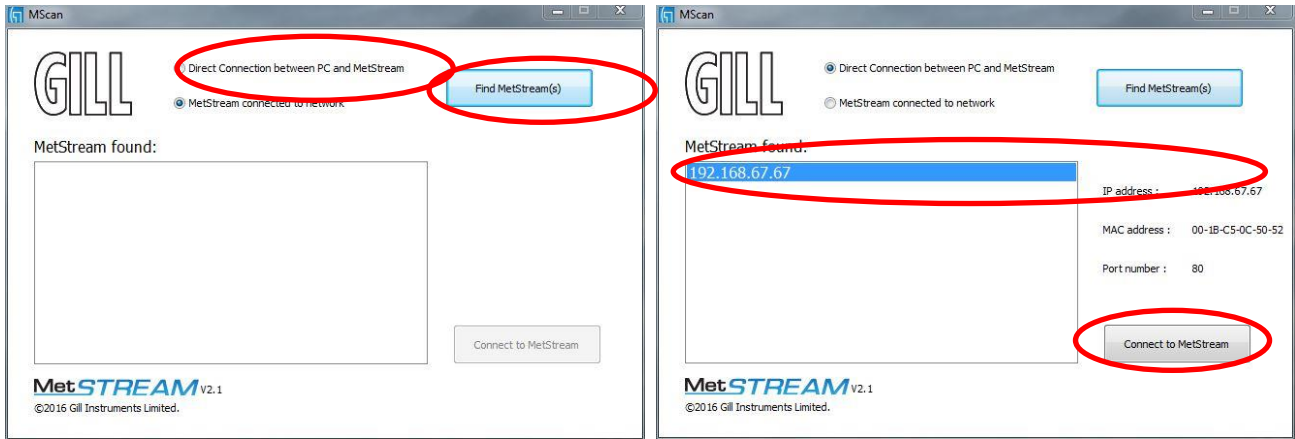

Your default browser will be launched and connect to the MetStream homepage

Note: It will not be possible to use MScan if the default browser port is changed from port 80. Please see section 6.5.7 for further information.

If the opening screen does not appear to reflect the currently connected equipment then clear the Browser Cache and refresh the display.

In Chrome the cache can be cleared by selecting 'Customise and control Google Chrome/History/Clear browsing history'. Then select only 'Empty the cache'.

Now Configure or retrieve MetStream data as per Para 6.5.

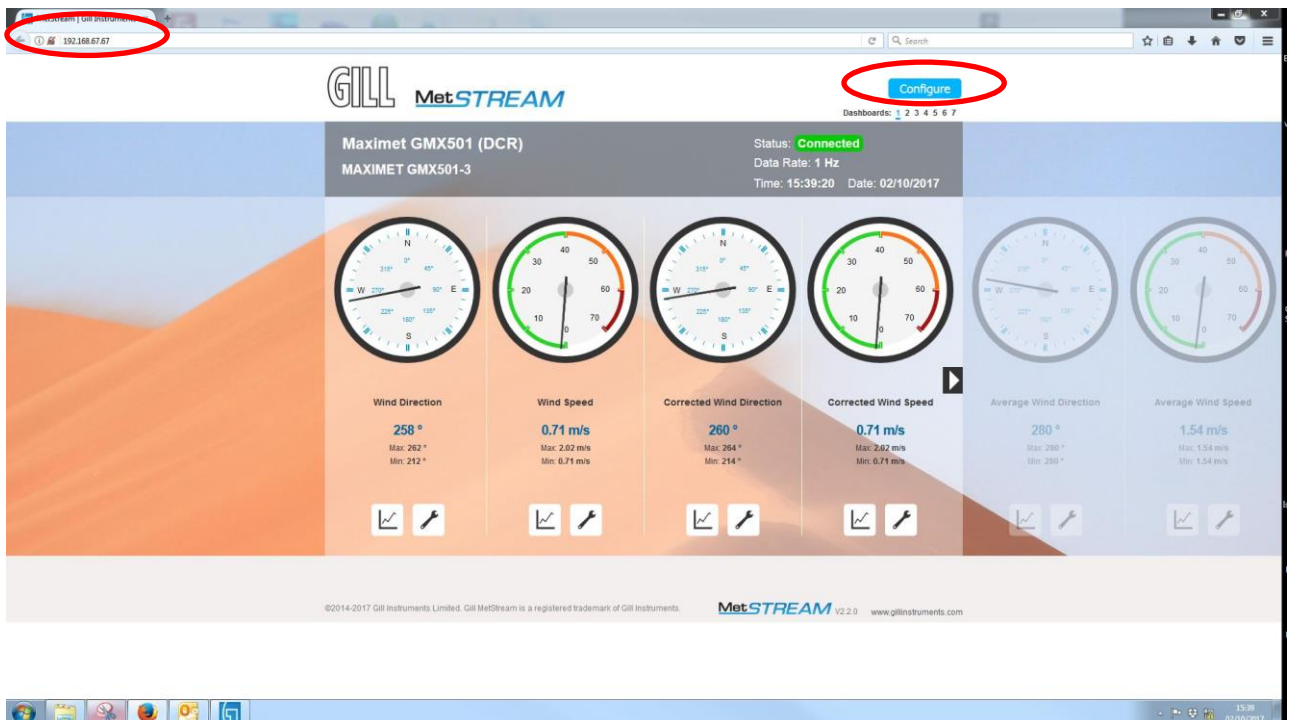

6.1.2 PC/Laptop Set Up if Gill MScan Software is not available.

If the PC/laptop has a Wi Fi connection then temporarily disable this function to connect to MetStream via a direct Ethernet crossover cable connection.

Apply power to MetStream 100 (wait for 90 seconds before attempting to access it for data).

On the PC select Start/
Select/
Control Panel/
Network and Sharing Center/
Local Area Connection/
Properties.

On Windows 10 Pc's, Select Start, Settings, Network and Internet, Ethernet, Change adaptor options, Ethernet, Properties

Double click on:-
Internet Protocol Version 4 (TCP/IPv4).

Now click on:-
'Use the following IP address'.

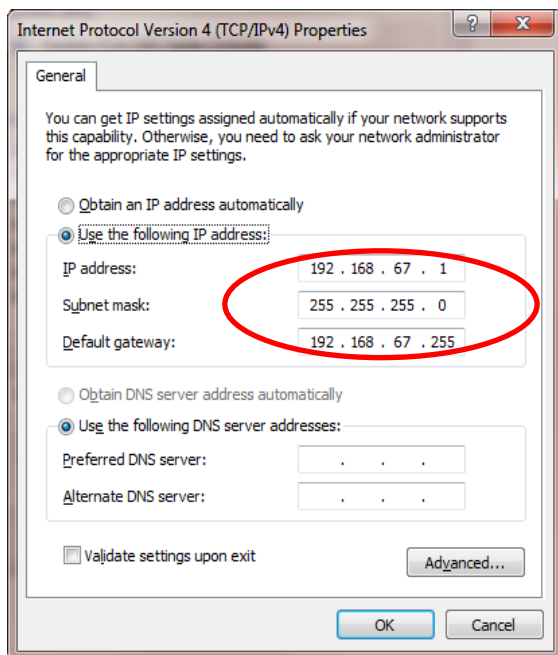
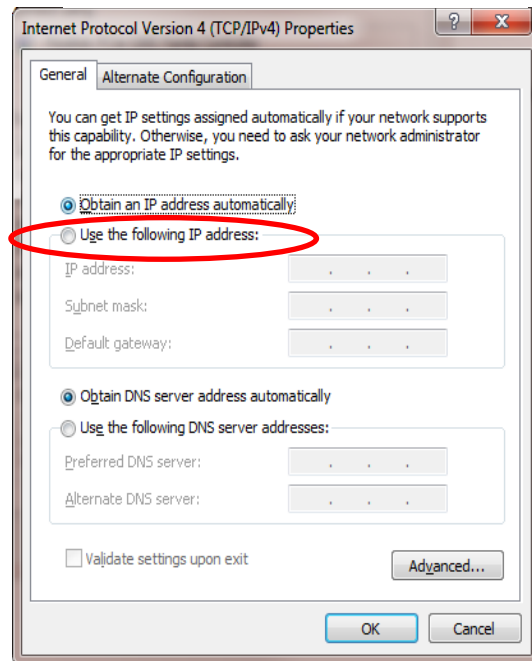
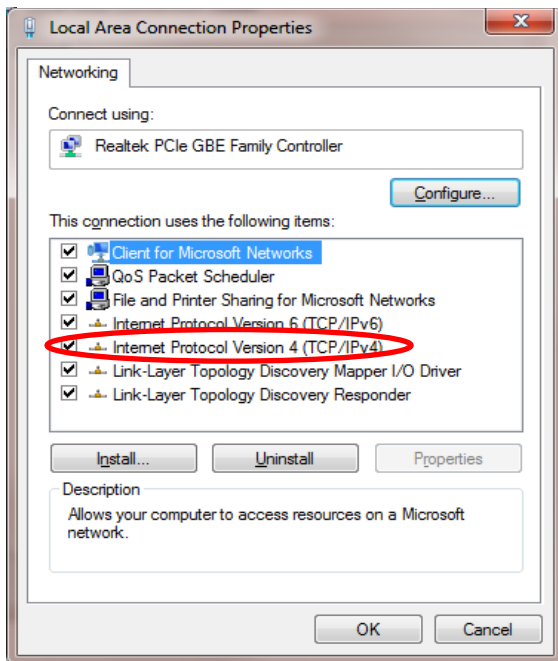

Type in the PC IP address **192.168.67.1**
(cannot be the same as the MetStream default IP address 192.168.67.67).

Type in Subnet Mask **255.255.255.0**.

Type in Default gateway **192.168.67.255**.

Click on OK.

On the PC open Internet Explorer (or equivalent) browser window.

Type in a default MetStream IP address 192.168.67.67. This IP address can be used irrespective of any fixed IP address that may have been previously set.

If the opening screen does not appear to reflect the currently connected equipment then clear the Browser Cache and refresh the display.

In Chrome the cache can be cleared by selecting 'Customise and control Google Chrome/History/Clear browsing history'. Then select only 'Empty the cache'.

Now Configure or retrieve MetStream data as per Para 6.5.

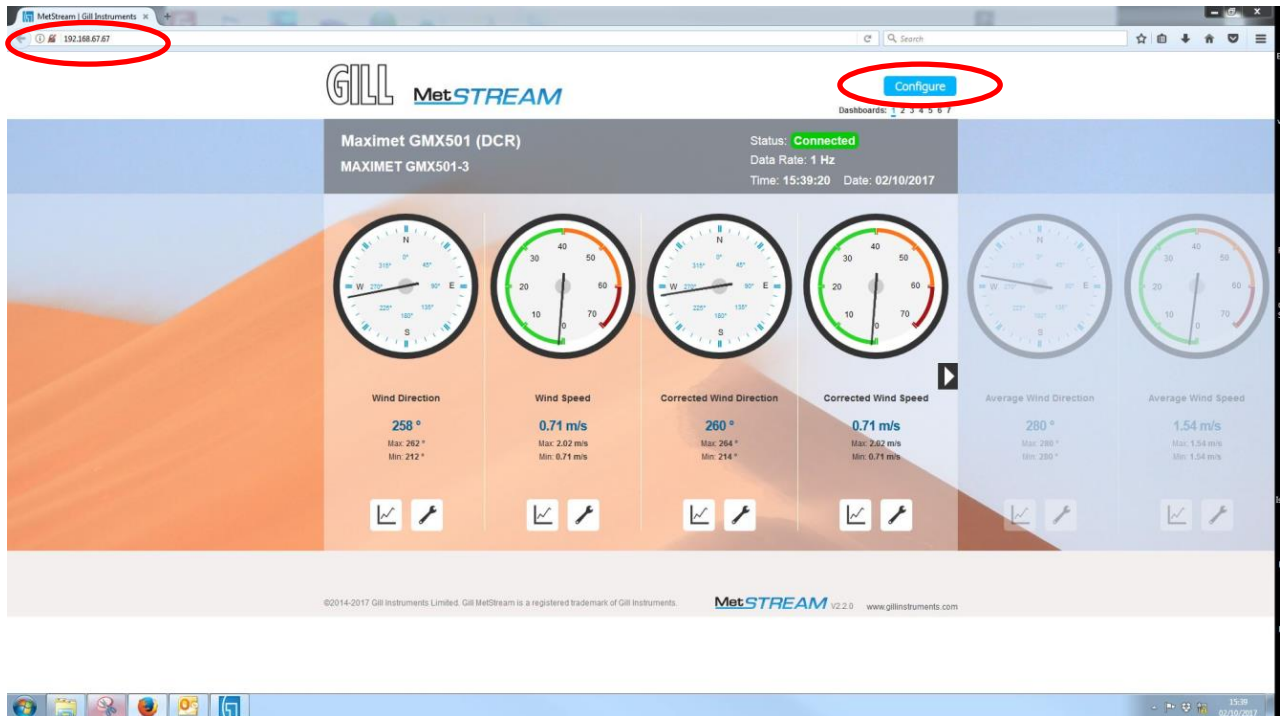

Upon completion of configuration to return the PC/Laptop to its previous state then:-

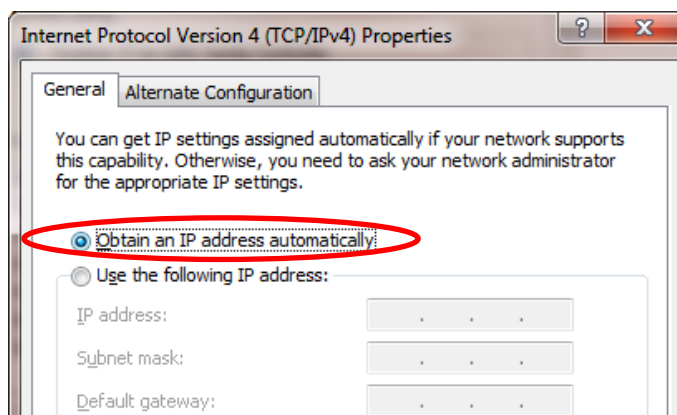

On the PC select Start/Select/Control Panel/Network and Sharing Center/Local Area Connection/Properties.

Double click on Internet Protocol Version 4 (TCP/IPv4).

Click on Obtain an IP address automatically and then click OK etc.

Re-enable the PC/Laptop wireless function as appropriate.

6.2 Accessing the MetStream GUI using a PC and a Wi-Fi Router

Note:- Alternative Wi-Fi connected devices may be used to connect to the MetStream unit to view the GUI if required e.g. Tablet or Smart Phone however the Gill MScan Software will only run on a PC to determine the IP address. Alternative IP Scan app software will be needed.

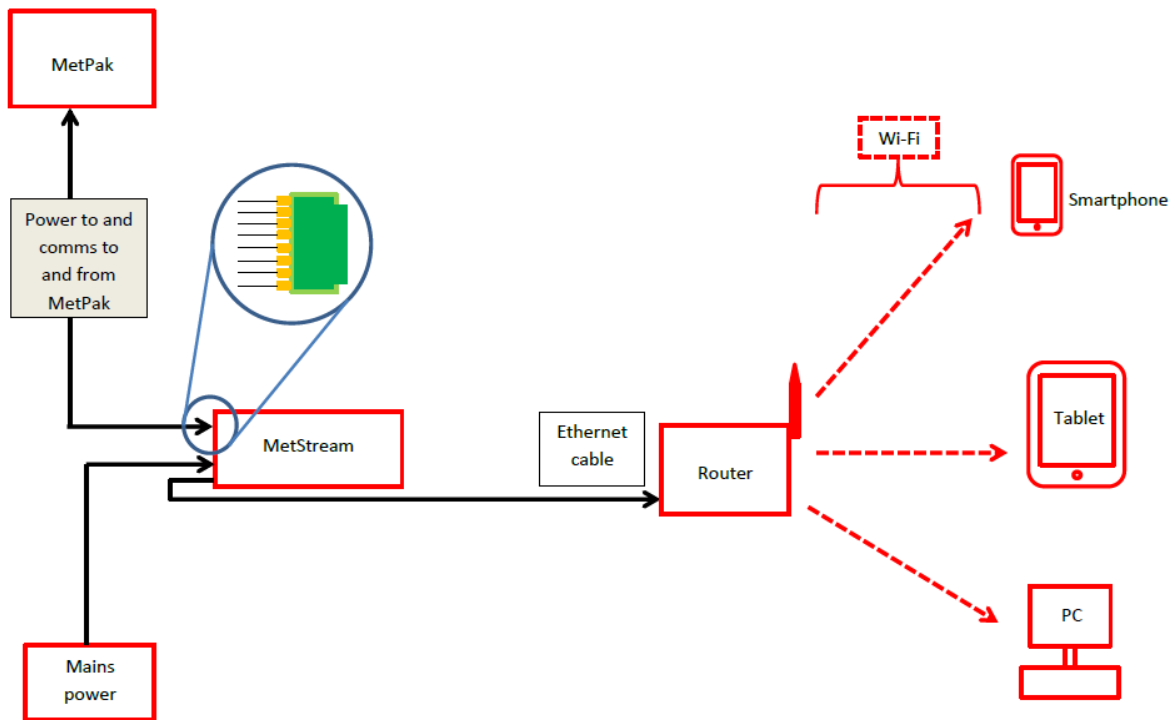

Connect MetStream to a Wi-Fi Router using the 2 metre Ethernet Cable supplied or any standard non crossover Ethernet cable.

On first applying power to the MetStream 100, wait for 90 seconds before attempting to access it for data.

If not already connected to the WI Fi Router on the PC select:-

Start/

Select/

Control Panel/

Network and Sharing Center/

Select the appropriate Wi Fi Network and log on to the Wi Fi Network (the Wi Fi password may be needed).

Once connected to the Wi Fi network load and open Gill MScan Software on to the PC.
Select 'MetStream Connected to Network'.
Click on the 'Find MetStream' button.

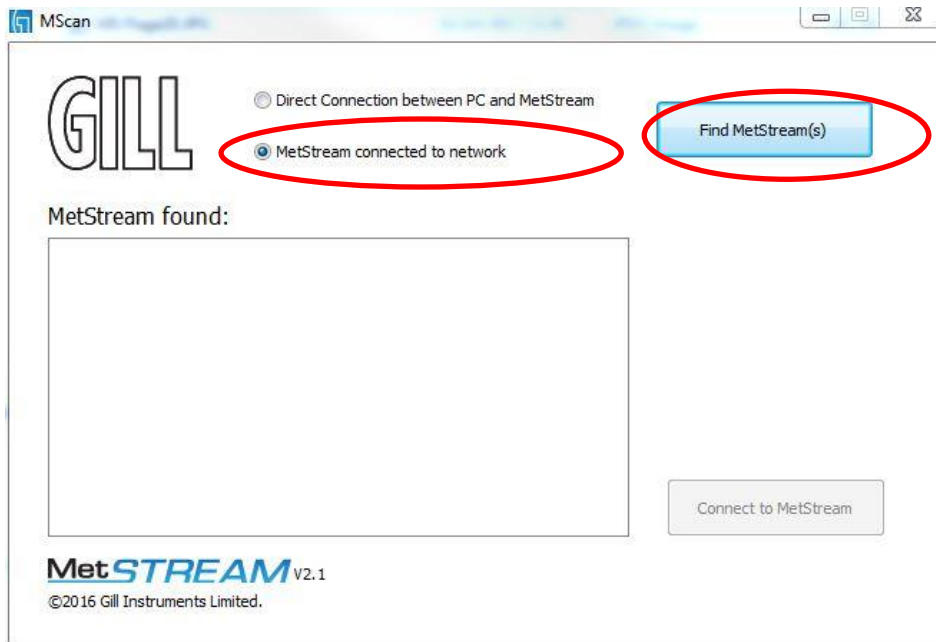

A list of available MetStreams will be listed with their IP addresses.

Note: It will not be possible to use MScan if the default browser port is changed from port 80. Please see section 6.5.7 for further information.

Click on the appropriate 'MetStream found at xxxxx' IP address to highlight the one to connect to.

Click on 'Connect to MetStream'.

Your default browser will be launched and will connect to the MetStream homepage.

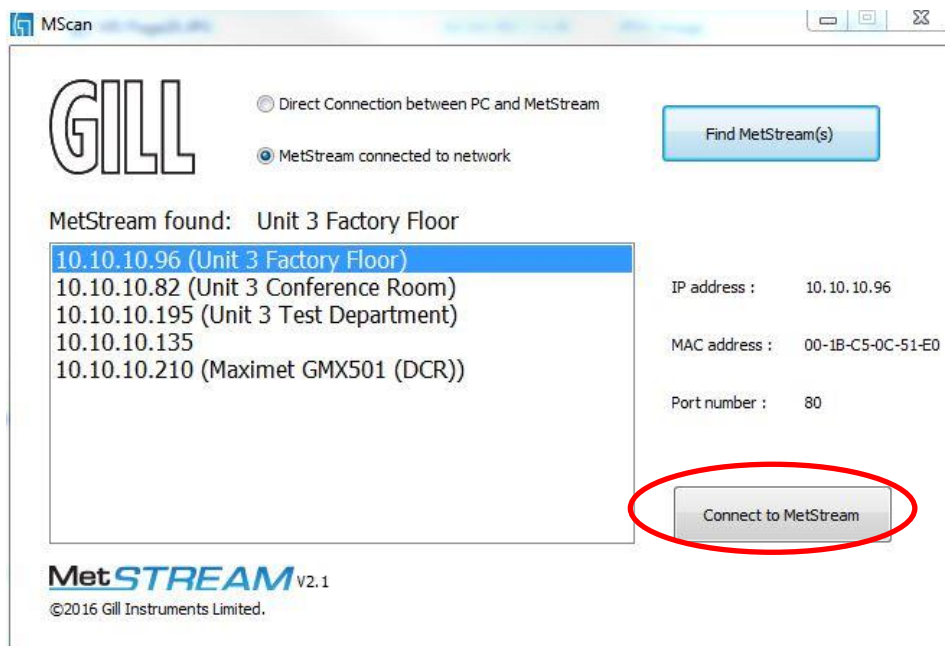

NOTE the MetStream IP address is detected by the Wi Fi Router and can change each time MetStream is powered up if the MetStream unit is set for DHCP. Use Configure to fix the IP Address of MetStream if required.

If the opening screen does not appear to reflect the currently connected equipment then clear the Browser Cache and refresh the display.

In Chrome the cache can be cleared by selecting ‘Customise and control Google Chrome/History/Clear browsing history’. Then select only ‘Empty the cache’.

Now Configure or retrieve MetStream data as per Para 6.5.

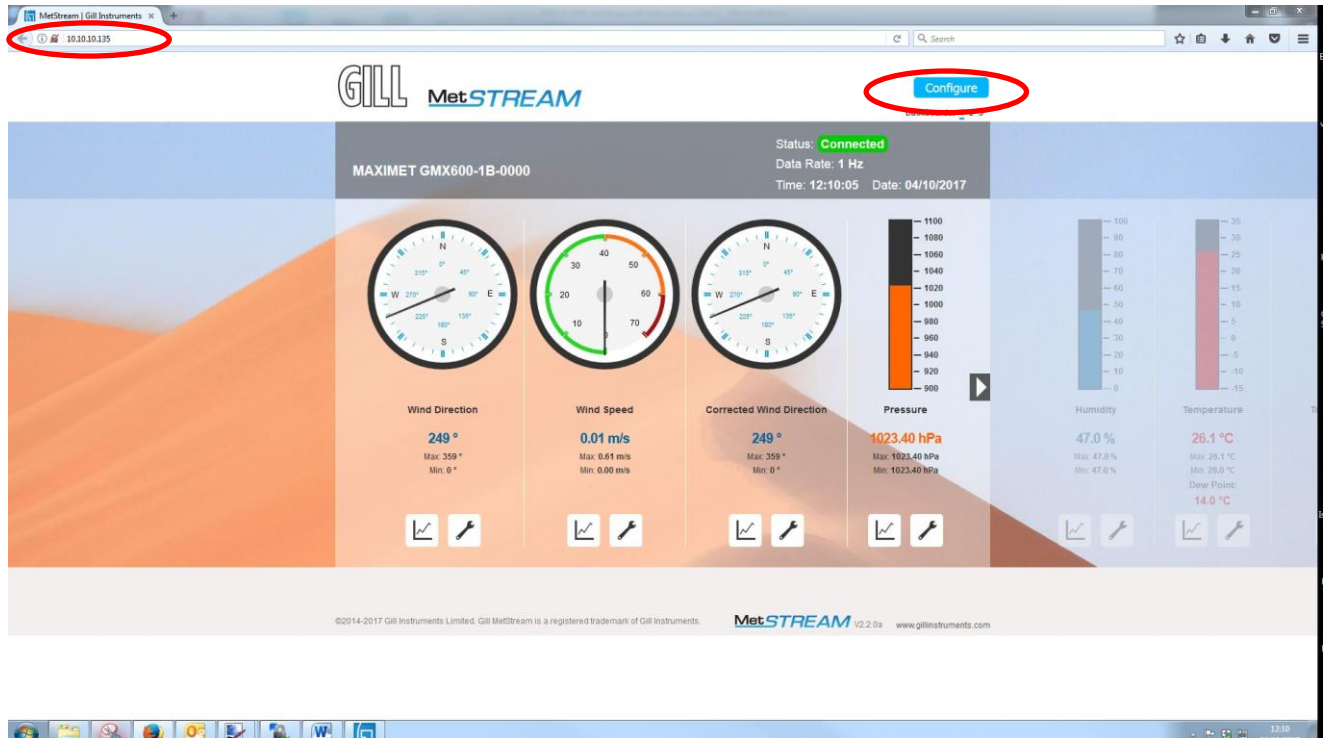

6.3 Accessing the MetStream GUI using a PC and a LAN Port.

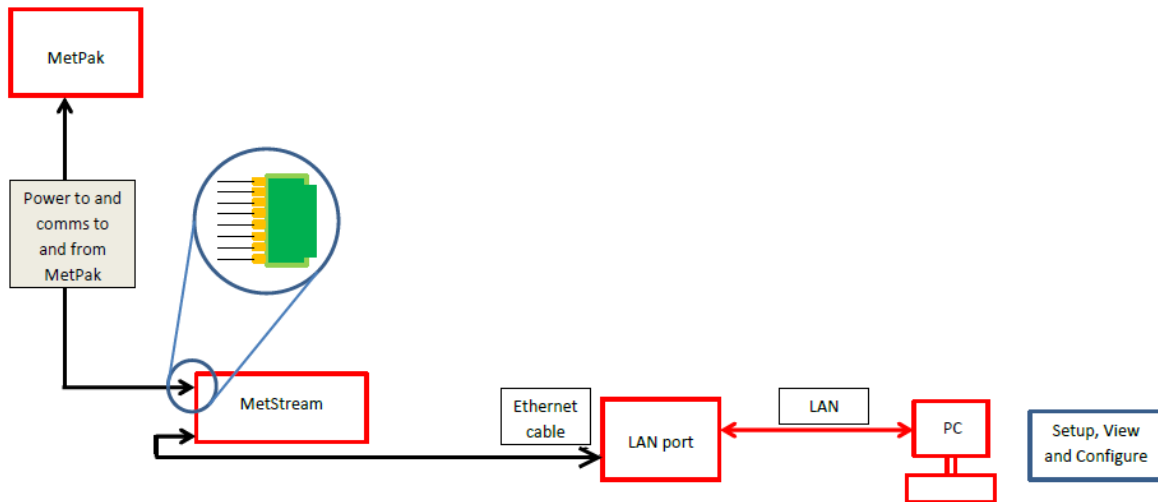

Connect MetStream to a LAN connection using the 2 metre Ethernet Cable supplied or any standard non crossover Ethernet cable.

On first applying power to the MetStream 100, wait for 90 seconds before attempting to access it for data.

Open Gill MScan Software load and Open Gill MScan Software on to the PC.

Select 'MetStream Connected to Network'.

Click on the 'Find MetStream' button.

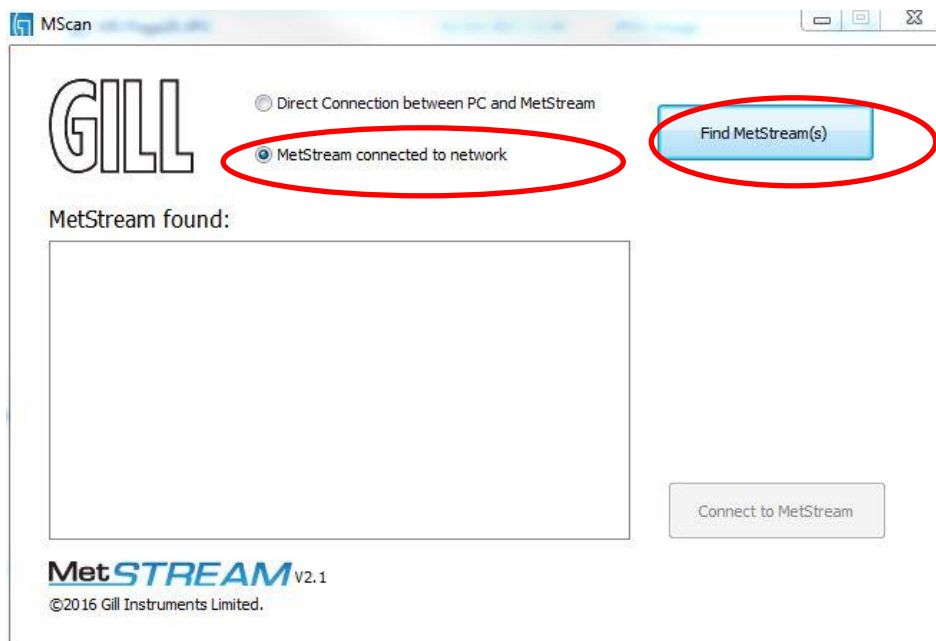

A list of available MetStreams will be listed with their IP addresses.

Click on and highlight the MetStream found at IP address that you want to connect to.

Click on 'Connect to MetStream'.

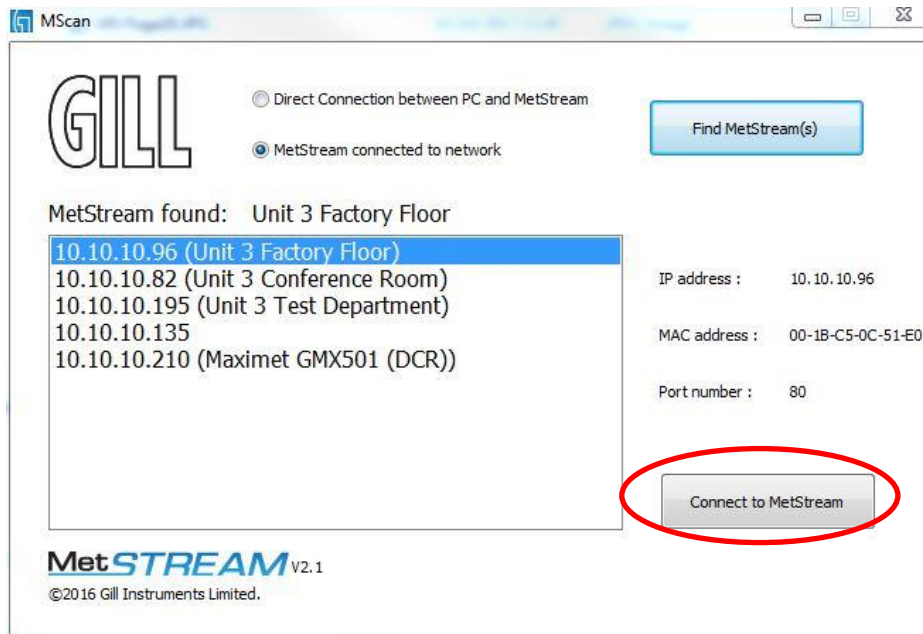

Your default browser will be launched and will connect to the MetStream homepage.

If the opening screen does not appear to reflect the currently connected equipment then clear the Browser Cache and refresh the display.

In Chrome the cache can be cleared by selecting 'Customise and control Google Chrome/History/Clear browsing history'. Then select only 'Empty the cache'.

Now Configure or retrieve MetStream data as per Para 6.5.

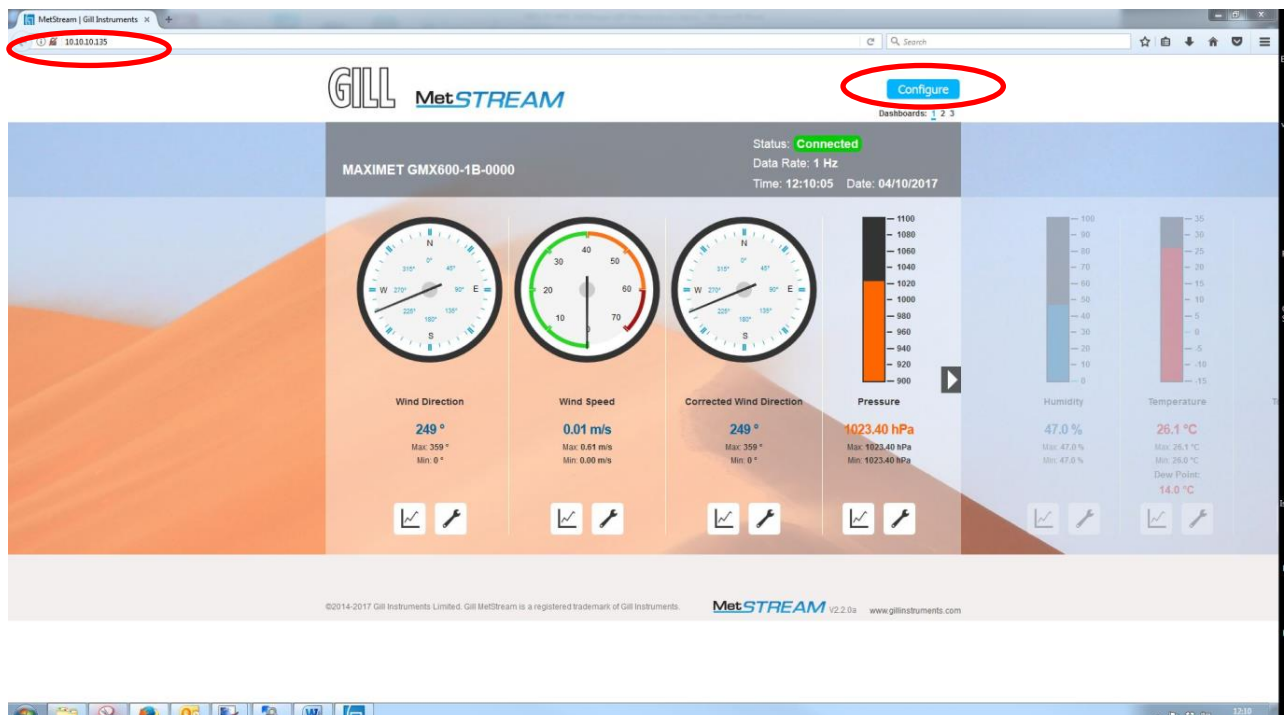

6.4 MetStream Front Page GUI Features.

Once a Web Browser connection has been established then it is possible to view the connected instrument data.

6.4.1 Open Browser Window

Type in the IP address e.g. 192.168.1.67 and Enter

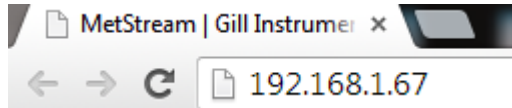

MetStream will communicate with the attached RS232/422/485 connected device, read settings, log data automatically and display data in a graphical format.

In this case a Gill MaxiMet GMX600 is connected to the MetStream device and the Graphical User Interface (GUI) opens with the following display.

6.4.2 Dashboards

MaxiMet parameters open on Dashboard 1, to display further MaxiMet instruments click on Dashboards 2 and 3.

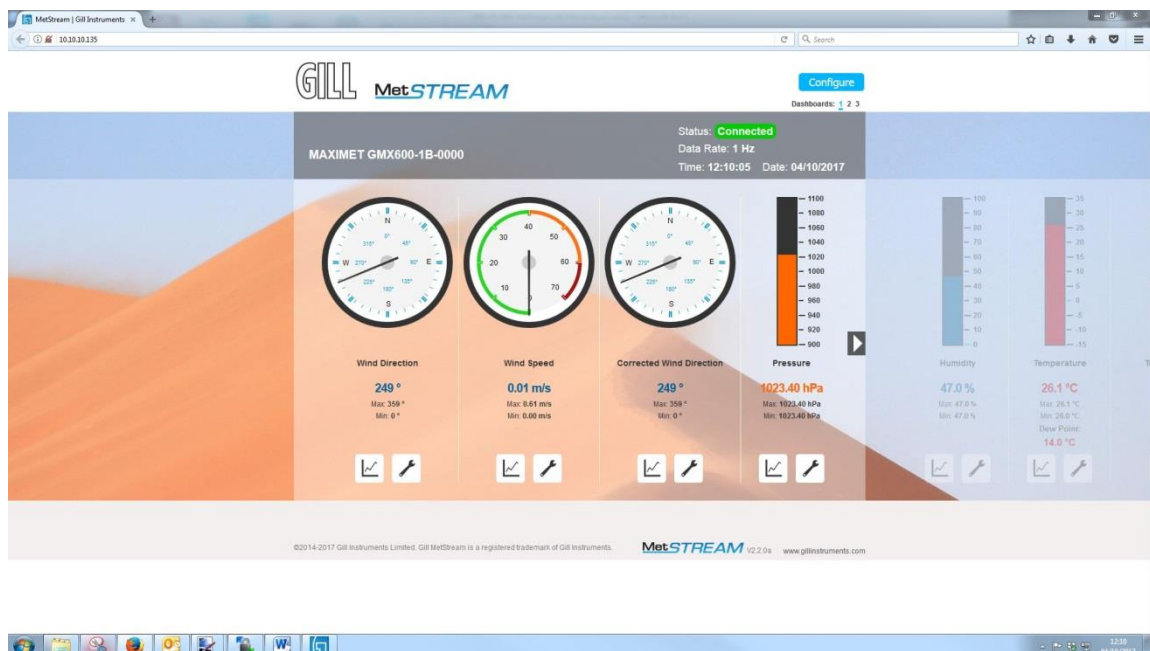

Dashboard 2 instrument display shown as follows:-

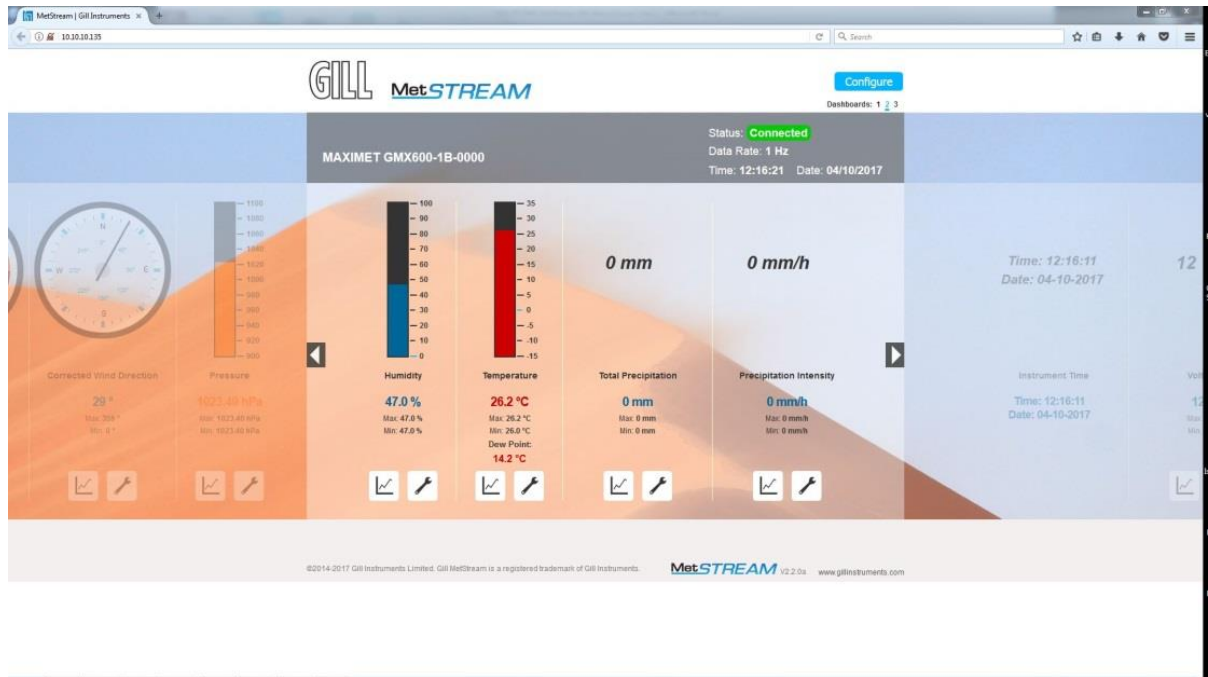

Dashboard 3 instrument display shown as follows:-



Where applicable at the bottom of the MetStream parameter display there are 2 tool signs.



6.4.3 Trend Graphs

Click on the Trend Graph



icon to open a trend graph of the parameter of interest.

E.g. Wind Direction.

Select a trend period value as required.

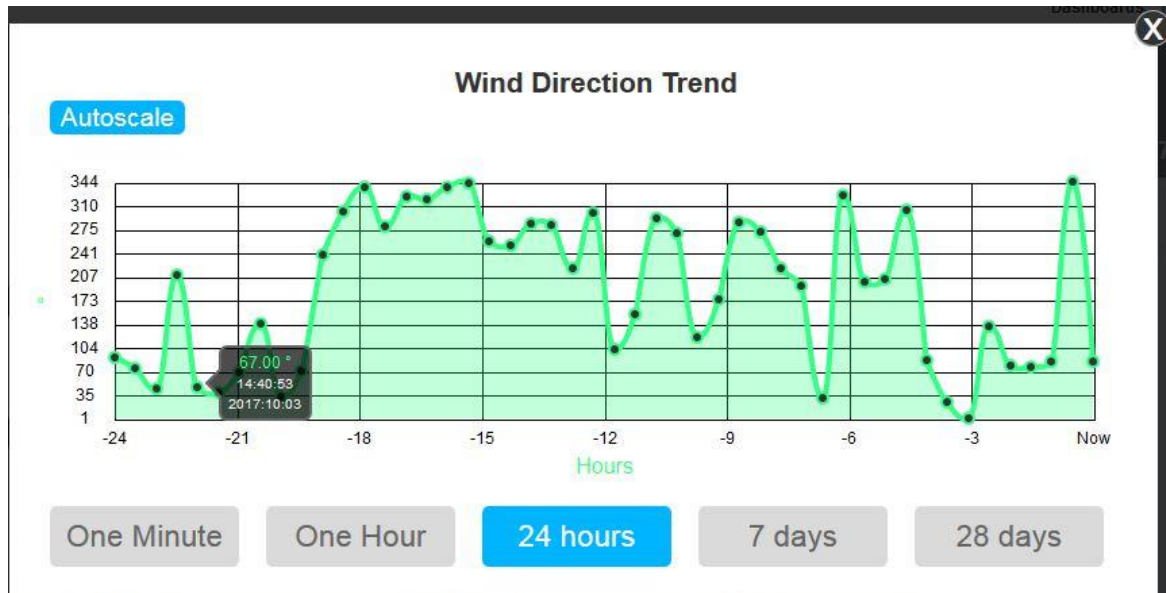

AutoScale

Automatically adjusts the Vertical axis to the maximum and minimum data values read in the plot period.

If Auto scale is not selected then the vertical scale will be set between instrument zero to maximum possible readings.

Trend Graph Sampling Periods.

- One Minute screen - a reading is taken every second.
- One Hour Screen - a reading is taken once every minute.
- 24 hours screen - a reading is taken once every 30 minutes.
- 7 days - a reading is taken once every 3 hours (00:00, 03:00, 06:00 etc.).
- 28 days - a reading is taken once every 3 hours (00:00, 03:00, 06:00 etc.).

Trend plots are built from the logged data stored in the MetStream. On power up, it may take several minutes for all of the plots to be populated from the stored data.

6.4.4 Change Reading Measurement Type, Gauge Range and Reset Max/Min.

Click on the  icon.

For example choose the on screen Wind Speed Measurement Type e.g. m/s.

Set the on screen Gauge Range Start and End values e.g. 0 and 70.

Reset on screen max or min values as required, click on Save Settings.

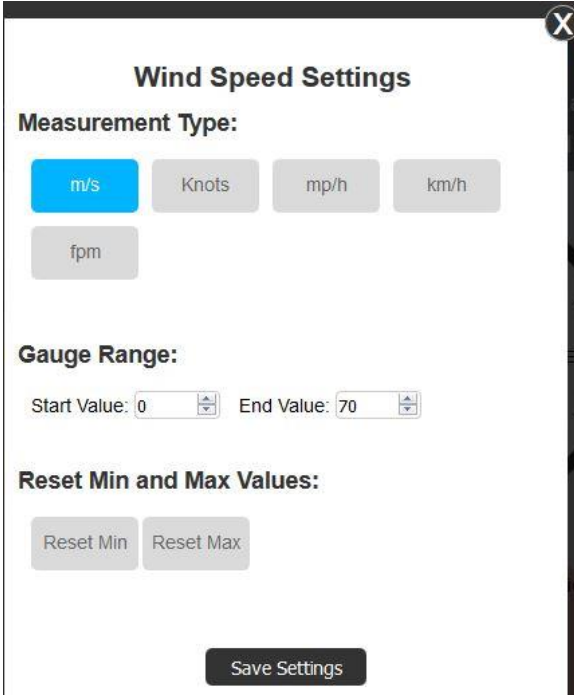

Wind Speed Settings

Measurement Type:

m/s Knots mp/h km/h
fpm

Gauge Range:

Start Value: 0 End Value: 70

Reset Min and Max Values:

Reset Min Reset Max

Save Settings

NOTES:

‘Save settings’ only saves settings for the period that the browser window is open. If the browser window is refreshed or PC re-started then the display will revert to the default screen settings on first opening MetStream.

Browser Window saved settings are only applicable to the PC on which MetStream is viewed.

Saved Settings do not change the MetStream unit configuration.

If Global use PC browser settings need to be changed then use MetStream Configure (password protected) to make changes to MetStream.

6.5 MetStream Configuration (Administrator Use)

Access to the Configure pages is dependent on having username and password access.

Click on the Configure  icon at the top of the main screen.

6.5.1 Login

Enter Username and Password.

(MetStream units are shipped with a default username and password as follows).

Username: admin (default, note all lowercase letters).

Password: password (default, note all lower case letters).

Click on Login.

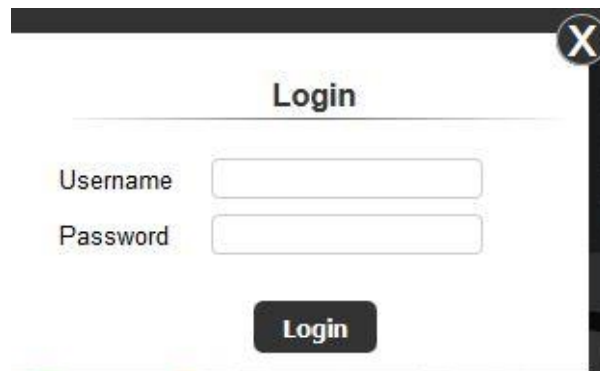

The screenshot shows a 'Login' window with a title bar and a close button (X). Inside the window, there are two input fields: 'Username' and 'Password'. Below the fields is a 'Login' button.

This will bring you to the opening MetStream Configuration screen.

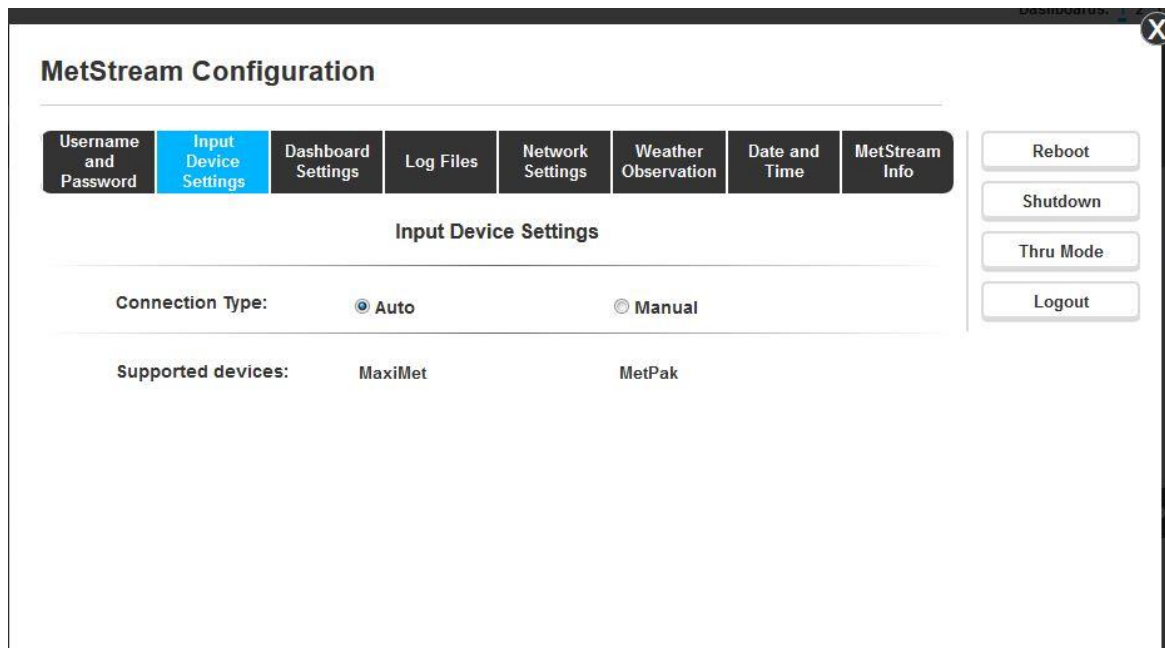

The screenshot shows the 'MetStream Configuration' screen. At the top, there is a navigation bar with tabs: 'Username and Password', 'Input Device Settings' (highlighted in blue), 'Dashboard Settings', 'Log Files', 'Network Settings', 'Weather Observation', 'Date and Time', and 'MetStream Info'. To the right of the navigation bar are four buttons: 'Reboot', 'Shutdown', 'Thru Mode', and 'Logout'. Below the navigation bar, the 'Input Device Settings' section is visible. It includes a 'Connection Type' section with radio buttons for 'Auto' (selected) and 'Manual'. Below that is a 'Supported devices' section with 'MaxiMet' and 'MetPak' options.

6.5.2 Exit/Reboot/Shutdown/Thru Mode/Logout

On the left hand side of the Configuration screen there are five buttons:-



Exit without saving (and) – Go back to GUI front screen without changing settings but will still be logged into configure screen. If you then click on Configure you will be taken to the Configure tabs without having to login again.

Reboot MetStream – An electrical power down of MetStream that will need a refresh of the Web browser screen.

Shutdown MetStream – Turns off power inside the MetStream box. This will require MetStream to be powered up to view the web GUI again.

WARNING: This command will require the physical removal of the power from the MetStream and the reapplication of power. MetStream cannot be restarted remotely once this command has been issued.

Enable Thru Mode – A mode to allow other software (e.g. a Terminal Programme) to access the connected instrument to view or change its settings (see Para 6.5.11).

Logout – Go back to the GUI screen this time if accessing Configure then a new login will be required.

6.5.3 Username and Password

If it is required to change the default Username and Password then select this page as follows:-

To change the Password complete the fields identified below and click on Submit.

MetStream Configuration

Username and Password | Input Device Settings | Dashboard Settings | Log Files | Network Settings | Weather Observation | Date and Time | MetStream Info

Reboot | Shutdown | Thru Mode | Logout

Username and Password

Confirm Current Credentials | Change Password

Current Username: New Password:

Current Password: Confirm New Password:

Submit

Click on OK as below and this takes you back to the Main Dashboard screen to log in with the new Password.

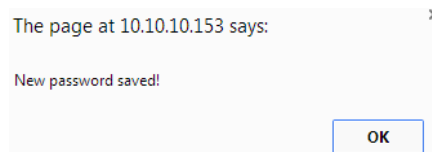

To change the Username select this option from the Username or Password dropdown menu.

Complete the New Username fields identified below and click on Submit.

MetStream Configuration

Username and Password | Input Device Settings | Dashboard Settings | Log Files | Network Settings | Weather Observation | Date and Time | MetStream Info

Reboot | Shutdown | Thru Mode | Logout

Username and Password

Confirm Current Credentials | Change Username

Current Username: New Username:

Current Password:

Submit

Note you cannot change password and user name at the same time. They must be done separately.

6.5.4 Input Device Settings

When Input Device Settings is selected Connection Type will show Auto as the default setting.

Auto Mode

The Auto selection (default setting) allows MetStream to automatically detect any of the instruments detailed in the Supported Devices list and log the data string data that they are outputting.

Auto mode currently supports the MetPak and MaxiMet range of weather stations.

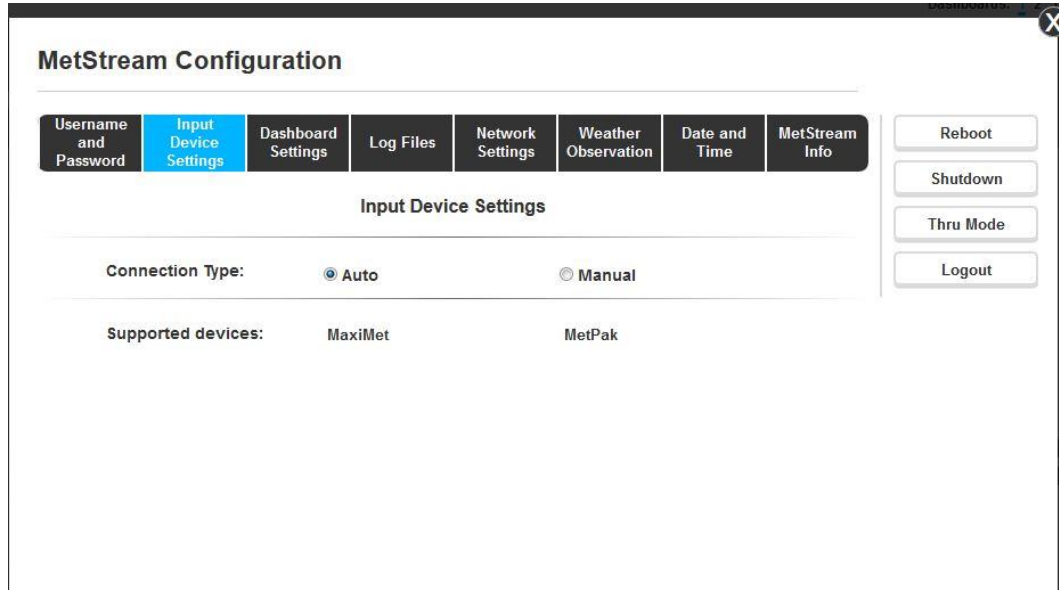

When Auto mode is selected then the connected device settings can be read and will be shown as per the following example with a connected MetPak Pro.

If a device needs to be connected that is not on the supported list use Manual Mode set up or contact Gill Instruments for advice.

MetStream Configuration

Username and Password | **Input Device Settings** | Dashboard Settings | Log Files | Network Settings | Weather Observation | Date and Time | MetStream Info

Reboot | Shutdown | Thru Mode | Logout

Input Device Settings

Connection Type: Auto Manual

Device name: MAXIMET GMX600-1B-0

Baud Rate: 19200 Interface: RS422/485

Parity: none Output Mode: Continuous Mode Polled mode

Stop: 1 bit

ASCII Setup

Message Start Character: 0x02

Message End Character: 0x0d

MetStream Configuration

Username and Password | **Input Device Settings** | Dashboard Settings | Log Files | Network Settings | Weather Observation | Date and Time | MetStream Info

Reboot | Shutdown | Thru Mode | Logout

Parameters Reported Number of Parameters: 14

Field 1: Node	Field 2: Wind Direction DEG	Field 3: Wind Speed MS
Field 4: Corrected Wind Dir DEG	Field 5: Pressure HPA	Field 6: Humidity %
Field 7: Temperature C	Field 8: Dew Point C	Field 9: Total Precipitation MM
Field 10: Precipitation Intens MM/H	Field 11: Instrument Time	Field 12: Voltage V
Field 13: Status	Field 14: Check	

Save Settings

NOTE: ASCII Setup, Message Delimiter Comma only is currently supported.

Manual Mode

The following example covers displaying and logging data from a Gill WindSonic or WindObserver settings with unit set for default output and with an RS422 connection to MetStream.

Select comma separated fields for WindSonic/WindObserver as below, Wind Speed units are set to match those coming from the WindSonic/WindObserver (default Metres/Second).

Ignore fields are those that cannot be displayed by the MetStream graphical display.

However note that ignored fields are still logged by MetStream and will be reported in any saved data.

Click on save settings.

Below is an example of the settings required for an NMEA device (Baud rate would typically be 4800).

MetStream Configuration

Username and Password | **Input Device Settings** | Dashboard Settings | Log Files | Network Settings | Weather Observation | Date and Time | MetStream Info

Reboot | Shutdown | Thru Mode | Logout

Input Device Settings

Connection Type: Auto Manual

Device name:

Baud Rate: Interface:

Parity: Output Mode: Continuous Mode Polled mode

Stop:

ASCII Setup

Message Start Character:

Message End Character:

MetStream Configuration

Username and Password | **Input Device Settings** | Dashboard Settings | Log Files | Network Settings | Weather Observation | Date and Time | MetStream Info

Reboot | Shutdown | Thru Mode | Logout

ASCII Setup

Message Start Character:

Message End Character:

Message Delimiter:

Parameters Reported Number of Parameters:

Field 1:

Field 2:

Field 3:

Field 4:

Field 5:

Field 6:

Leave Wind Speed units at Metres/Second.

Change Wind Direction to 0 and 359

Change Wind Speed Scale to that required e.g. 0-60m/s

Select required direction style.

Select a background either use the default or select from 5 other pre-set backgrounds.

Select a Dashboard Title e.g. WindSonic or WindObserver etc.

Click on Save Settings.

Return to Main Screen to display the wind data (refresh display if necessary).

POLLED MODE

Baud Rate:	9600	Interface:	RS422/485
Parity:	none	Output Mode:	<input type="radio"/> Continuous Mode <input checked="" type="radio"/> Polled mode
Stop:	1 bit	Polled Character:	?Q
		Rate (Hz):	2

Poll Character to match that of the instrument node letter.

Poll Rate 1-32 to match the capability of the connected unit polled mode.

Message Delimiter - Comma, Space, tab, semi-colon, other. Comma only is currently supported.

6.5.5 Dashboard Settings (Administrator Use)

Note: Changing Dashboard Settings affects the MetStream data view seen by all PC's using the same MetStream Web browser IP address.

Select a background image from the available options or choose custom to upload a user image. Custom user images must be smaller than 1MB, formatted as a jpg, have a resolution of 2560x654 and have the file extension type formatted as lower case.

Choose appropriate front GUI dashboard settings as required (MetPak connected equipment settings illustrated).

Default Measurement Ranges/Units relate to all instrument measurements that are shown with a gauge and digital reading rather than just a digital reading on the front GUI screen.

The screenshot displays the 'MetStream Configuration' web interface. The 'Dashboard Settings' tab is selected, showing various configuration options. On the right side, there are buttons for 'Reboot', 'Shutdown', 'Thru Mode', and 'Logout'. The main configuration area includes:

- Dashboard title:** A text input field.
- Select Background Image:** A dropdown menu currently set to 'Desert'.
- Wind Direction Dial Style:** Radio buttons for 'NSEW' (selected) and 'Maritime'.
- Default Units:**
 - Wind Speed: MS
 - Pressure: HPA
 - Temperature: C
 - Total Precipitation: MM
 - Precipitation Intensity: MM/H
- Default Measurement Ranges:**
 - Wind Speed: 0 to 70
 - Pressure: 900 to 1100
 - Humidity: 0 to 100
 - Temperature: -15 to 35

Click on Save Settings when changes have been made.

Refresh the web page to see the changes.

6.5.6 Measurement Log

Data Logging Notes:

MetStream logs data to an internal SD card (not user removable).

Data logging occurs continuously once MetStream is connected to a recognised/configured external instrument; in this case data logging cannot be disabled.

If no unit (e.g. MetPak) is connected to the MetStream then no data is logged.

Logging will not occur if the MetStream is set for NTP or STP whilst directly connected to a PC (only in Manual time mode and time set).

MetStream logs data at the output rate of the connected instrument (up to 32Hz).

MetStream creates daily log files up to a maximum of 96 after which the oldest dated folder is deleted.

Logged data can be downloaded to a PC or to a USB flash drive connected to MetStream.

Saving Logged Data to a PC Download Location

Select the Measurement Log Tab.

MetStream Configuration

Username and Password | Input Device Settings | Dashboard Settings | **Log Files** | Network Settings | Weather Observation | Date and Time | MetStream Info

Reboot | Shutdown | Thru Mode | Logout

Log Files

Select files to be copied or deleted:

<input type="checkbox"/>	Select All		
<input type="checkbox"/>	Log: 04/10/2017	CSV	ZIP
<input type="checkbox"/>	Log: 03/10/2017	CSV	ZIP
<input type="checkbox"/>	Log: 02/10/2017	CSV	ZIP
<input type="checkbox"/>	Log: 01/10/2017	CSV	ZIP
<input type="checkbox"/>	Log: 30/09/2017	CSV	ZIP
<input type="checkbox"/>	Log: 29/09/2017	CSV	ZIP
<input type="checkbox"/>	Log: 28/09/2017	CSV	ZIP
<input type="checkbox"/>	Log: 27/09/2017	CSV	ZIP
<input type="checkbox"/>	Log: 26/09/2017	CSV	ZIP
<input type="checkbox"/>	Log: 25/09/2017	CSV	ZIP
<input type="checkbox"/>	Log: 24/09/2017	CSV	ZIP
<input type="checkbox"/>	Log: 23/09/2017	CSV	ZIP
<input type="checkbox"/>	Log: 22/09/2017	CSV	ZIP

Refresh external drives

Delete selected files

Copy files to:

*** No drives found ***

Copy selected files

If for instance you had selected the box of Log: 03/10/2017 and clicked on **CSV** this would save a MSLOG_20171003.csv file to the PC Downloads Folder.

(E.g. Start/Documents/Downloads (MSLOG_Year/Month/Day.csv file).

If **ZIP** had been clicked on then this would save a zip file MSLOG_20171003.zip to the PC Downloads Folder.

This file can automatically open in a spreadsheet format if for instance Microsoft Excel or Libre Office Calc are installed on the PC as per the following example. Otherwise the data can be opened as a Comma Separated text file.

Larger files can take a few minutes to download.

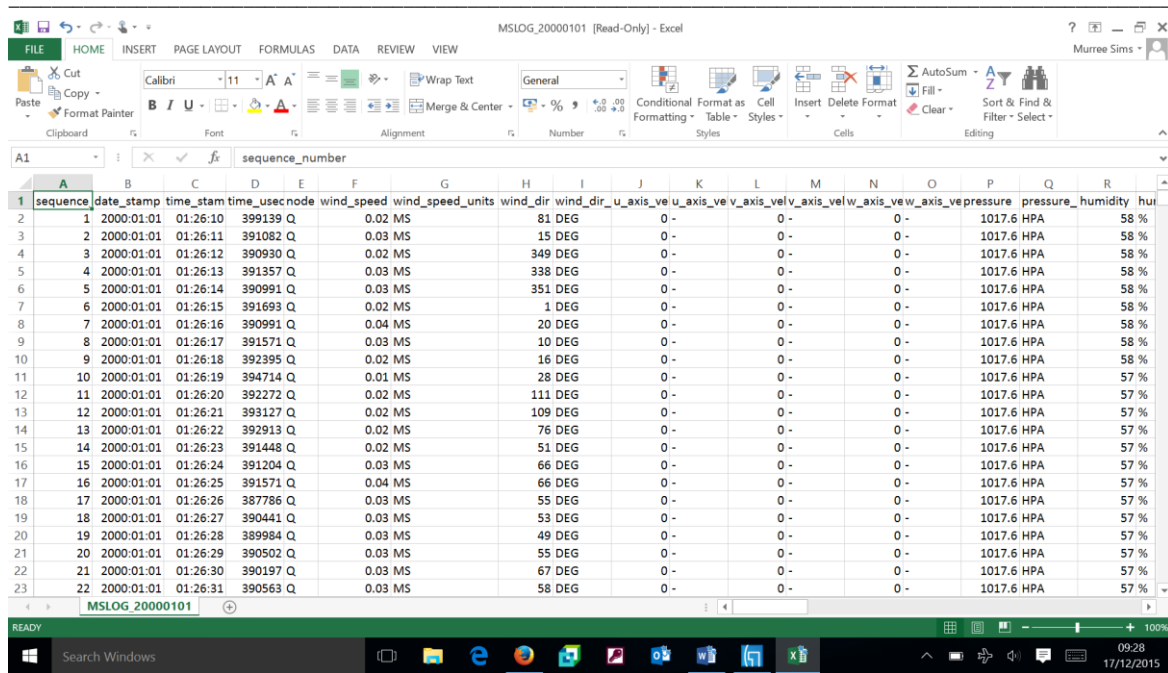

Saving Data to a USB Flash Drive

Data logged and saved to the internal SD card can be manually copied to an external USB flash drive. Data is not automatically or directly sent to the USB flash drive.

MetStream will support USB flash drives up to 32GB.

If no external flash drive has been connected to MetStream then this will be reported (No Drives Found).

If a USB flash drive has been inserted then when the MetStream Measurement Log screen is reached an external drive will be recognised e.g. usbhd-sda1.

Log Files

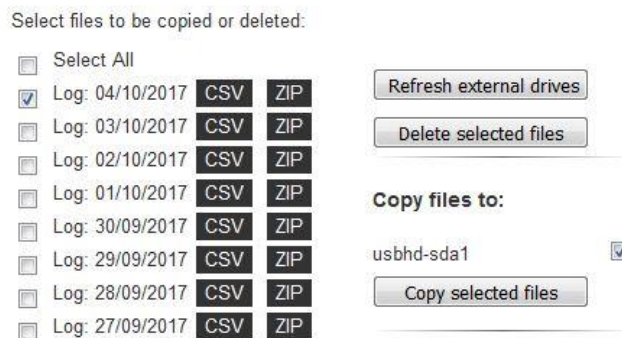

When connecting a USB drive to MetStream after power up then open the Measurement Log screen and click on 'Refresh external drives'.

Note: When MetStream is first switched on the day/month/year defaults to 01/01/2000 until Date and Time are configured. The log file created for this date can be deleted if required.

Click on the external drive tick box (e.g. usbhd-sda1) to enable copying of files (highlights selected files options).

Click on Log or Logs to be saved (e.g. Log 03/10/2017).

Click on Ok

After 5-10 seconds MetStream will report.

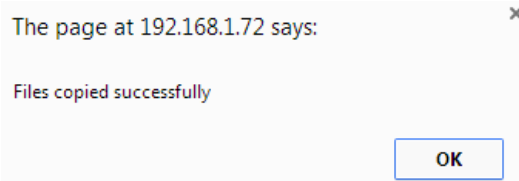

Data is saved on the USB flash drive as a .CSV file identified as for example by MSLOG_20171003 (Year 2017/Month10/Day03).

This file can automatically open in a spreadsheet format if for instance Microsoft Excel or Libre Office Calc are installed on the PC as per the following example.

sequence	date_stamp	time	start_time	user	node	wind_spe	wind_dir	wind_dir_u_axis	u_axis_vel	v_axis_vel	w_axis_vel	w_axis_ve	pressure	humidity	humidity	temperat	temperat	dewpoint	dewpoint	prt	prts_units	speed_of	speed_of	sonic_tem	sonic_tem
1	2013-11-06	11:19:41	244673	Q		0.2 MS	170 DEG	0	0	0	0	0	1001 HPA	65.1 %	20.3 C	56.4 F	0	0	0	0	0	0	0	0	0
2	172	2013-11-06	11:19:42	244401	Q	0.23 MS	168 DEG	0	0	0	0	0	1001 HPA	65.1 %	20.3 C	56.4 F	0	0	0	0	0	0	0	0	0
3	173	2013-11-06	11:19:43	244709	Q	0.23 MS	200 DEG	0	0	0	0	0	1001 HPA	65.1 %	20.3 C	56.4 F	0	0	0	0	0	0	0	0	0
4	174	2013-11-06	11:19:44	244743	Q	0.22 MS	164 DEG	0	0	0	0	0	1001 HPA	65.1 %	20.3 C	56.3 F	0	0	0	0	0	0	0	0	0
5	175	2013-11-06	11:19:45	244837	Q	0.23 MS	174 DEG	0	0	0	0	0	1001 HPA	65.1 %	20.3 C	56.3 F	0	0	0	0	0	0	0	0	0
6	176	2013-11-06	11:19:46	245023	Q	0.25 MS	187 DEG	0	0	0	0	0	1001 HPA	65.1 %	20.3 C	56.3 F	0	0	0	0	0	0	0	0	0
7	177	2013-11-06	11:19:47	244843	Q	0.26 MS	172 DEG	0	0	0	0	0	1001 HPA	65 %	20.3 C	56.3 F	0	0	0	0	0	0	0	0	0
8	178	2013-11-06	11:19:48	244968	Q	0.19 MS	172 DEG	0	0	0	0	0	1001 HPA	65 %	20.3 C	56.3 F	0	0	0	0	0	0	0	0	0
9	179	2013-11-06	11:19:49	244971	Q	0.18 MS	150 DEG	0	0	0	0	0	1001 HPA	65 %	20.3 C	56.3 F	0	0	0	0	0	0	0	0	0
10	180	2013-11-06	11:19:50	245218	Q	0.22 MS	159 DEG	0	0	0	0	0	1001 HPA	65 %	20.3 C	56.3 F	0	0	0	0	0	0	0	0	0
11	181	2013-11-06	11:19:51	245190	Q	0.21 MS	178 DEG	0	0	0	0	0	1001 HPA	65 %	20.3 C	56.3 F	0	0	0	0	0	0	0	0	0
12	182	2013-11-06	11:19:52	245193	Q	0.2 MS	171 DEG	0	0	0	0	0	1001 HPA	65 %	20.3 C	56.3 F	0	0	0	0	0	0	0	0	0
13	183	2013-11-06	11:19:53	245257	Q	0.16 MS	179 DEG	0	0	0	0	0	1001 HPA	65 %	20.3 C	56.3 F	0	0	0	0	0	0	0	0	0
14	184	2013-11-06	11:19:54	245229	Q	0.18 MS	175 DEG	0	0	0	0	0	1001 HPA	65.1 %	20.3 C	56.3 F	0	0	0	0	0	0	0	0	0
15	185	2013-11-06	11:19:55	245354	Q	0.21 MS	150 DEG	0	0	0	0	0	1001 HPA	65.1 %	20.3 C	56.3 F	0	0	0	0	0	0	0	0	0
16	186	2013-11-06	11:19:56	245418	Q	0.21 MS	179 DEG	0	0	0	0	0	1001 HPA	65.1 %	20.3 C	56.4 F	0	0	0	0	0	0	0	0	0
17	187	2013-11-06	11:19:57	245573	Q	0.2 MS	177 DEG	0	0	0	0	0	1001 HPA	65.2 %	20.3 C	56.4 F	0	0	0	0	0	0	0	0	0
18	188	2013-11-06	11:19:58	245515	Q	0.16 MS	184 DEG	0	0	0	0	0	1001 HPA	65.2 %	20.3 C	56.4 F	0	0	0	0	0	0	0	0	0
19	189	2013-11-06	11:19:59	245579	Q	0.24 MS	176 DEG	0	0	0	0	0	1001 HPA	65.2 %	20.3 C	56.4 F	0	0	0	0	0	0	0	0	0
20	190	2013-11-06	11:20:00	245674	Q	0.23 MS	170 DEG	0	0	0	0	0	1001 HPA	65.2 %	20.3 C	56.4 F	0	0	0	0	0	0	0	0	0
21	191	2013-11-06	11:20:01	245676	Q	0.22 MS	180 DEG	0	0	0	0	0	1001 HPA	65.2 %	20.3 C	56.4 F	0	0	0	0	0	0	0	0	0
22	192	2013-11-06	11:20:02	245496	Q	0.21 MS	180 DEG	0	0	0	0	0	1001 HPA	65.2 %	20.3 C	56.4 F	0	0	0	0	0	0	0	0	0
23	193	2013-11-06	11:20:03	245896	Q	0.27 MS	197 DEG	0	0	0	0	0	1001 HPA	65.2 %	20.3 C	56.5 F	0	0	0	0	0	0	0	0	0
24	194	2013-11-06	11:20:04	245838	Q	0.18 MS	191 DEG	0	0	0	0	0	1001 HPA	65.2 %	20.3 C	56.5 F	0	0	0	0	0	0	0	0	0
25	195	2013-11-06	11:20:05	245871	Q	0.15 MS	205 DEG	0	0	0	0	0	1001 HPA	65.2 %	20.3 C	56.5 F	0	0	0	0	0	0	0	0	0
26	196	2013-11-06	11:20:06	245935	Q	0.2 MS	171 DEG	0	0	0	0	0	1001 HPA	65.2 %	20.3 C	56.5 F	0	0	0	0	0	0	0	0	0
27	197	2013-11-06	11:20:07	245907	Q	0.14 MS	177 DEG	0	0	0	0	0	1001 HPA	65.2 %	20.3 C	56.4 F	0	0	0	0	0	0	0	0	0
28	198	2013-11-06	11:20:08	246032	Q	0.15 MS	196 DEG	0	0	0	0	0	1001 HPA	65.2 %	20.3 C	56.4 F	0	0	0	0	0	0	0	0	0
29	199	2013-11-06	11:20:09	246035	Q	0.17 MS	173 DEG	0	0	0	0	0	1001 HPA	65.2 %	20.3 C	56.4 F	0	0	0	0	0	0	0	0	0
30	200	2013-11-06	11:20:10	246129	Q	0.19 MS	171 DEG	0	0	0	0	0	1001 HPA	65.2 %	20.3 C	56.4 F	0	0	0	0	0	0	0	0	0
31	201	2013-11-06	11:20:11	246254	Q	0.13 MS	175 DEG	0	0	0	0	0	1001 HPA	65.2 %	20.3 C	56.4 F	0	0	0	0	0	0	0	0	0
32	202	2013-11-06	11:20:12	246396	Q	0.18 MS	177 DEG	0	0	0	0	0	1001 HPA	65.2 %	20.3 C	56.4 F	0	0	0	0	0	0	0	0	0
33	203	2013-11-06	11:20:13	246290	Q	0.22 MS	182 DEG	0	0	0	0	0	1001 HPA	65.1 %	20.3 C	56.4 F	0	0	0	0	0	0	0	0	0
34	204	2013-11-06	11:20:14	246324	Q	0.18 MS	183 DEG	0	0	0	0	0	1001 HPA	65.1 %	20.3 C	56.4 F	0	0	0	0	0	0	0	0	0
35	205	2013-11-06	11:20:15	246388	Q	0.11 MS	194 DEG	0	0	0	0	0	1001 HPA	65.1 %	20.3 C	56.4 F	0	0	0	0	0	0	0	0	0
36	206	2013-11-06	11:20:16	246543	Q	0.14 MS	188 DEG	0	0	0	0	0	1001 HPA	65.1 %	20.3 C	56.4 F	0	0	0	0	0	0	0	0	0
37	207	2013-11-06	11:20:17	246516	Q	0.23 MS	176 DEG	0	0	0	0	0	1000.9 HPA	65.1 %	20.3 C	56.4 F	0	0	0	0	0	0	0	0	0
38	208	2013-11-06	11:20:18	246549	Q	0.19 MS	167 DEG	0	0	0	0	0	1000.9 HPA	65.1 %	20.3 C	56.4 F	0	0	0	0	0	0	0	0	0
39	209	2013-11-06	11:20:19	246522	Q	0.2 MS	164 DEG	0	0	0	0	0	1000.9 HPA	65.1 %	20.3 C	56.4 F	0	0	0	0	0	0	0	0	0
40	210	2013-11-06	11:20:20	246341	Q	0.23 MS	174 DEG	0	0	0	0	0	1000.9 HPA	65.1 %	20.3 C	56.4 F	0	0	0	0	0	0	0	0	0
41	211	2013-11-06	11:20:21	246619	Q	0.17 MS	156 DEG	0	0	0	0	0	1001 HPA	65.1 %	20.3 C	56.4 F	0	0	0	0	0	0	0	0	0
42	212	2013-11-06	11:20:22	246896	Q	0.22 MS	179 DEG	0	0	0	0	0	1000.9 HPA	65 %	20.3 C	56.4 F	0	0	0	0	0	0	0	0	0

6.5.7 Network Settings

Automatic IP address (DHCP)

The default Network setting is to obtain an IP address automatically using a Dynamic Host Configuration Protocol (DHCP). Thus the MetStream IP address will be allocated to it when connected to a Wi Fi Router or LAN Server.

The screenshot shows the 'MetStream Configuration' web interface. At the top, there is a navigation menu with tabs: Username and Password, Input Device Settings, Dashboard Settings, Log Files, Network Settings (highlighted in blue), Weather Observation, Date and Time, and MetStream Info. To the right of the menu are buttons for Reboot, Shutdown, Thru Mode, and Logout. Below the menu, the 'Network Settings' section is displayed. It has two main sections: 'LAN Interface' and 'WLAN Interface'. In the 'LAN Interface' section, the radio button for 'Obtain an IP address automatically (DHCP)' is selected, while 'Use a static IP address:' is unselected. The 'WLAN Interface' section has radio buttons for 'On' and 'Off', with 'Off' selected. Below these sections are input fields for 'Hostname:' (metstream-100), 'Web Server Port:' (80), and 'Thru Mode TCP Port:' (8023). A 'Save Settings' button is located at the bottom center of the configuration area.

Static IP Address

If a Static IP address is required for the MetStream connection then click on Use a Static IP address and complete the form.

When connecting MetStream in a system that has no DNS or DHCP server, it may be necessary to set up a static IP address (see Para 6.1.2 to determine the IP address).

This screenshot shows the 'LAN Interface' section of the 'Network Settings' page. The radio button for 'Use a static IP address:' is selected. Below this, there are four rows of input fields: 'IP address:' (192.168.1.250), 'Subnet mask:' (255.255.255.0), 'Default gateway:' (192.168.1.254), and 'DNS:' (8.8.8.8 8.8.4.4).

WLAN Interface

The Wireless LAN Interface connection is not applicable to MetStream 100 (Use MetStream 105).

WLAN Interface Configuration ON OFF

Thru Mode TCP Port

If the MetStream is placed into Thru Mode, the TCP Port is by default set to 8023. This can be changed here if a different port is required. For further information on Thru Mode, please see section 6.5.12.

Hostname

It is possible to change the MetStream hostname from its default here.

Web Server Port

It is possible to change the web server port, which by default is set to 80. This is useful in instances where the MetStream is being port forwarded. For further information on port forwarding, please see section 6.5.13.

Please note: when this port is changed, it will no longer be possible to connect to the MetStream homepage by typing in the IP address alone. The full IP address and the port number will need to be entered into the web browsers address bar, for example:

192.168.1.100:1234

Please note: If the web server port is changed from its default setting of 80, it will no longer be possible to connect to the MetStream using MScan.

6.5.8 Weather Observation Website (WOW)

Applies to MetStream units that are connected to a device that has internet access.

The UK Meteorological Office have created a platform for collecting weather observation readings primarily from across the United Kingdom see <http://wow.metoffice.gov.uk/> (other countries have contributed data).

This can include data from instruments that are connected to MetStream that provide weather type data (e.g. the MetPak range). General details on WOW can be read at:- <http://wow.metoffice.gov.uk/support/general>

To register for sending data to the UK Met Office WOW site see the attached link:- <https://register.metoffice.gov.uk/WaveRegistrationClient/public/register.do?service=weatherobservations>

To send data to the Met Office site when an account has been set up, select the MetStream Weather Observation page.

Under Weather Observation Website:-

- Click on Enabled.
- Complete Site ID, Pin and Site Update Rate information.
- Click on Save Settings.

Data collected by MetStream will be sent automatically providing an internet link is established with the MetStream unit. The time interval for sending this data can be selected by the user

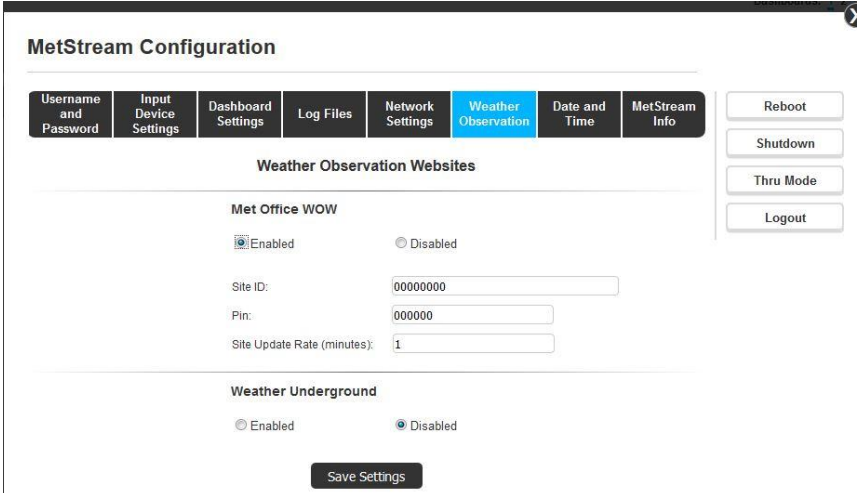

The screenshot shows the 'MetStream Configuration' window with the 'Weather Observation' tab selected. The 'Weather Observation Websites' section is visible, containing two sub-sections: 'Met Office WOW' and 'Weather Underground'. In the 'Met Office WOW' section, the 'Enabled' radio button is selected, and the 'Site ID' is set to '00000000', 'Pin' is '000000', and 'Site Update Rate (minutes)' is '1'. In the 'Weather Underground' section, the 'Disabled' radio button is selected. A 'Save Settings' button is located at the bottom of the configuration area. On the right side of the window, there are buttons for 'Reboot', 'Shutdown', 'Thru Mode', and 'Logout'.

NOTE:- Connection may be subject to changes to the WOW site by the Met Office.

6.5.9 Weather Underground

Applies to MetStream units that are connected to a device that has internet access.

Weather Underground is an internet based commercial weather service capable of providing real-time information based on data from the national weather service and personal weather stations registered with the website. Please see the Weather Underground home page for further information: <https://www.wunderground.com/>

To register on the Weather Underground site, please see the link below:

<https://www.wunderground.com/signup>

Once registered it will be possible to setup a personal weather station, during this process the website will provide a station ID and password that will need to be entered into the MetStream.

To send data to the Weather Underground site when an account has been set up, select the MetStream Weather Observation page.

Under Weather Underground:-

- Click on Enabled.
- Complete Site ID, Pin and Site Update Rate information.
- Click on Save Settings.

Data collected by MetStream will be sent automatically providing an internet link is established with the MetStream unit. The time interval for sending this data can be selected by the user

MetStream Configuration

Username and Password | Input Device Settings | Dashboard Settings | Log Files | Network Settings | **Weather Observation** | Date and Time | MetStream Info

Reboot | Shutdown | Thru Mode | Logout

Weather Observation Websites

Met Office WOW

Enabled Disabled

Weather Underground

Enabled Disabled

Station ID:

Password:

Site Update Rate (minutes):

Save Settings

NOTE:- Connection may be subject to changes to the Weather Underground site.

6.5.10 Date and Time

When MetStream is first powered up it opens with a default Time Zone, default 01/01/2000 date, zero hour time and default NTP.

Select the required Time Zone from the drop down menu and click on ‘Save Time Zone’.

Type in the required Time and Date into the relevant boxes and click on ‘Save Time & Date’.

It is important to choose the required Time Source carefully to ensure that data logging will take place.

Default ‘Change Time Source’ setting is NTP (see Notes below).

If PTP enabled (see Notes below) the screen will show:-

Notes:

Manual Time, for non-networked units, relies on MetStream internal clock.

If MetStream power is lost for more than a day then clock settings will be lost and logging will halt. Upon return of power Manual time settings will need to be reset.

Network Time Protocol (NTP) recommended setting for network connected PC’s which can obtain time synchronisation over the internet.

NTP setting will not pick up time if a direct Ethernet connection is being used with a PC.

If NTP selected but no connection to NTP source made then the unit cannot log data.

Precision Time Protocol (PTP) looks for the network provider master clock for specific closed networks.

PTP options data will show the IP address of the PTP source.

6.5.11 About

Reports various MetStream attributes that can be useful for record of unit build and fault finding.

The screenshot shows the 'MetStream Configuration' web interface. At the top, there is a navigation bar with several tabs: 'Username and Password', 'Input Device Settings', 'Dashboard Settings', 'Log Files', 'Network Settings', 'Weather Observation', 'Date and Time', and 'MetStream Info' (which is currently selected and highlighted in blue). To the right of the navigation bar are four buttons: 'Reboot', 'Shutdown', 'Thru Mode', and 'Logout'. Below the navigation bar, the 'MetStream Info' section displays the following information:

Hostname:	metstream-100		
MAC address:	00:1B:C5:0C:50:D5	WLAN MAC address:	n/a
IP address:	10.10.10.135	WLAN IP address:	n/a
Serial number:	15080002	Software build:	2.2.0a

At the bottom of the interface, there is a copyright notice: '©2014-2017 Gill Instruments Limited. Gill MetStream is a registered trademark of Gill Instruments.' Below this are two links: 'Licence Agreements' and 'www.gillinstruments.com'.

6.5.12 Thru Mode (Diagnostic Connection)

It is possible to communicate directly with a sensor attached to a MetStream using a terminal program, allowing you to view/log the raw sensor data in real time and if necessary re-configure the sensor.

NOTE: Data logging into the MetStream internal memory is DISABLED while Thru Mode is active.

Enable Thru Mode

Connect the sensor to MetStream and open the MetStream IP address GUI on a PC web browser as per examples in Paras 6.1 to 6.3.

Log in to Configuration screen and on the "Input Device Settings" check that is set to match the attached sensor (Auto for a MetPak). It is not necessary to setup the number of parameters or the fields. (If settings are changed it may be necessary to reload the page and log back into the configuration screen).

Click on the Network Settings Page which shows Thru Mode TCP Port Number e.g. 8023.

Click on the Enable Thru Mode button on the left hand side of the screen.

The screenshot shows the 'MetStream Configuration' web interface. At the top, there are several tabs: 'Username and Password', 'Input Device Settings', 'Dashboard Settings', 'Log Files', 'Network Settings' (which is highlighted in blue), 'Weather Observation', 'Date and Time', and 'MetStream Info'. Below the tabs, there are two main sections. The first section is for network configuration, with options for 'Obtain an IP address automatically (DHCP)' and 'Use a static IP address'. The static IP address is set to 192.168.1.250. The second section is for 'WLAN Interface', which is currently set to 'Off'. Below this, there are fields for 'Hostname' (metstream-100), 'Web Server Port' (80), and 'Thru Mode TCP Port' (8023). The 'Thru Mode TCP Port' field is circled in red. On the right side of the interface, there is a vertical sidebar with buttons for 'Reboot', 'Shutdown', 'Thru Mode' (circled in red), and 'Logout'. At the bottom of the main content area, there is a 'Save Settings' button.

The following warning screen appears, Click on OK (if using a crossover cable the page will be 192.168.67.67).

A simple dialog box with a white background and a grey border. The text inside reads 'Do you want to enable Thru Mode?'. At the bottom, there are two buttons: 'OK' and 'Cancel'.

MetStream will now re-boot to enable Thru mode.

Note: The following warning screen does not warn when 1 minute is up; hence close the MetStream Web browser window after clicking on ok.

A warning dialog box with a white background and a grey border. The text inside reads 'MetStream is now rebooting...' followed by 'This will take approximately 1 minute!'. Below the text is a circular progress indicator.

If required re-open the MetStream Web page e.g. 10.10.10.153 to confirm that Thru Mode has been enabled (see screen shot).

Close the Web Browser page connection.

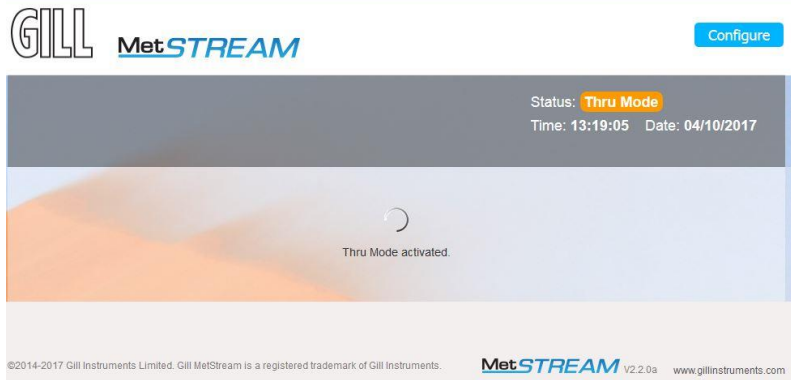

Open a Telnet terminal programme e.g. HyperTerminal.
Type in a Name, e.g. MetStream Thru Mode.
Click on OK.

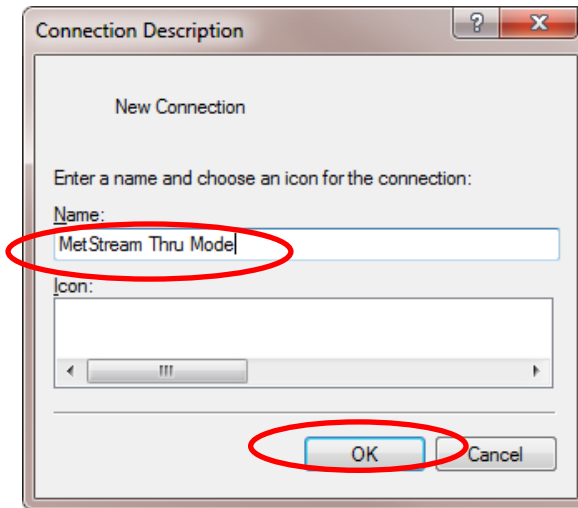

Select Connect Using from the drop down list to be TCP/IP.
Type in the Host Address (MetStream IP address) for example 10.10.10.153
Type in the Port Number which for MetStream will be 8023.
Click on OK.

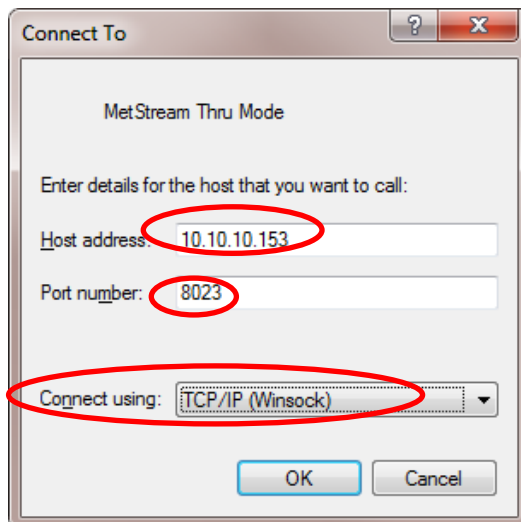

Data should now be scrolling on the Hyperterminal screen updated at the connected instrument output rate (MetPak Pro data illustrated).

```

00,353,000.03,1006.1,045.0,+021.2,+008.8,,+0003.5,+0002.5,0000.000,+12.0,00,▼4A
00,003,000.02,1006.1,044.9,+021.2,+008.8,,+0003.5,+0002.5,0000.000,+12.0,00,▼45
00,351,000.03,1006.1,044.9,+021.2,+008.8,,+0003.5,+0002.5,0000.000,+12.0,00,▼40
00,016,000.03,1006.1,044.9,+021.2,+008.8,,+0003.5,+0002.5,0000.000,+12.0,00,▼40
00,017,000.02,1006.1,044.9,+021.2,+008.8,,+0003.5,+0002.5,0000.000,+12.0,00,▼40
00,005,000.02,1006.1,044.9,+021.2,+008.8,,+0003.5,+0002.5,0000.000,+12.0,00,▼43
00,343,000.01,1006.1,044.9,+021.2,+008.8,,+0003.5,+0002.5,0000.000,+12.0,00,▼41

```

Should it be necessary to place the connected instrument into a Set Up mode/Configuration mode then send the necessary command (for Gill sensors this is the * command).

To interrogate the connected instrument:-

Type * to place the unit into Set up Mode (Enter key may be needed).

The connected MetPak Pro unit has responded with SETUP MODE.

Refer to the connected Sensor Manual to determine which Configuration or Test commands are applicable for a terminal mode connection.

In this MetPak example the 'Report' command has been typed, the Enter key pressed and the unit has responded with the fields that it is reporting to MetStream.

Type Q and press Enter key to return to normal measurement mode.

```

00,337,000.03,1006.1,044.9,+021.2,+008.8,,+0003.5,+0002.5,0000.000,+12.0,00,▼40
00,343,000.02,1006.1,044.9,+021.2,+008.8,,+0003.5,+0002.5,0000.000,+12.0,00,▼42
00,001,000.03,1006.1,044.9,+021.2,+008.8,,+0003.5,+0002.5,0000.000,+12.0,00,▼46
00,026,000.03,1006.1,044.9,+021.2,+008.8,,+0003.5,+0002.5,0000.000,+12.0,00,▼43
00,019,000.03,1006.1,044.9,+021.2,+008.8,,+0003.5,+0002.5,0000.000,+12.0,00,▼4F
00,014,000.03,1006.1,044.9,+021.2,+008.8,,+0003.5,+0002.5,0000.000,+12.0,00,▼42
00,001,000.04,1006.1,044.9,+021.2,+008.8,,+0003.5,+0002.5,0000.000,+12.0,00,▼41
00,013,000.04,1006.1,044.9,+021.2,+008.8,,+0003.5,+0002.5,0000.000,+12.0,00,▼42
00,025,000.02,1006.1,044.9,+021.2,+008.8,,+0003.5,+0002.5,0000.000,+12.0,00,▼41
00,020,000.03,1006.1,044.9,+021.2,+008.8,,+0003.5,+0002.5,0000.000,+12.0,00,▼45
00,357,000.03,1006.1,044.9,+021.2,+008.8,,+0003.5,+0002.5,0000.000,+12.0,00,▼46
00,349,000.04,1006.1,044.9,+021.2,+008.8,,+0003.5,+0002.5,0000.000,+12.0,00,▼4E
00,006,000.05,1006.1,044.9,+021.2,+008.8,,+0003.5,+0002.5,0000.000,+12.0,00,▼47
00,013,000.03,1006.1,044.9,+021.2,+008.8,,+0003.5,+0002.5,0000.000,+12.0,00,▼45
00,359,000.03,1006.2,044.9,+021.2,+008.8,,+0003.5,+0002.5,0000.000,+12.0,00,▼4B

SETUP MODE
> REPORT
REPORT = NODE,DIR,SPEED,PRESS,RH,TEMP,DEWPOINT,PRT,AN1,AN2,DIG1,VOLT,STATUS,CHEC
K
> Q
00,356,000.03,1006.2,045.1,+021.2,+008.8,,+0003.5,+0002.5,0000.000,+12.0,00,▼4D
00,356,000.03,1006.2,045.2,+021.2,+008.8,,+0003.5,+0002.5,0000.000,+12.0,00,▼4E

```

Logging Data

Hyperterminal can be used to log MetStream data (but note it will not add a Date/Time stamp to the data).

Start Logging

Select Transfer /Capture Text.

Then select Browse to choose a location/file on the PC to log the data.

Click on Start to commence data logging.

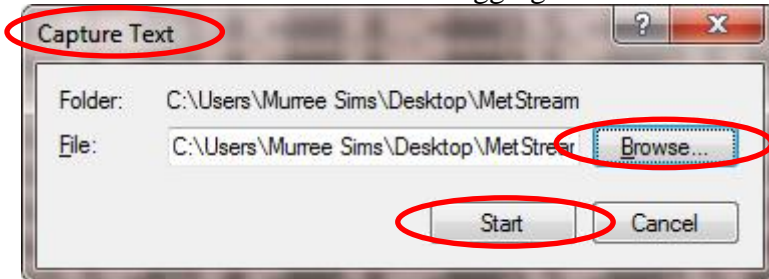

Stop Logging

Select Transfer/Capture Text/Stop.

Viewing Logged Data.

Open the saved data file location and view the text data e.g. using Notepad or similar.

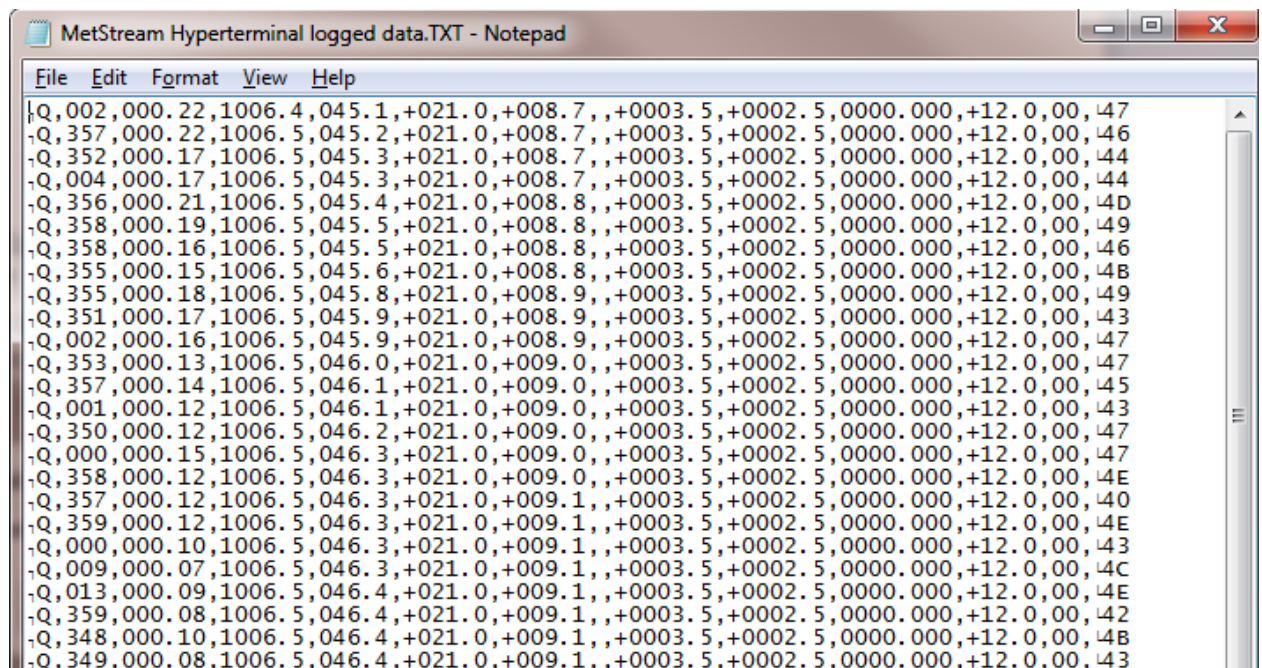

Disable Thru Mode

With any terminal connection to MetStream closed, open the Web Browser page and Log-In to the Configure pages.

Click on Disable Thru Mode.

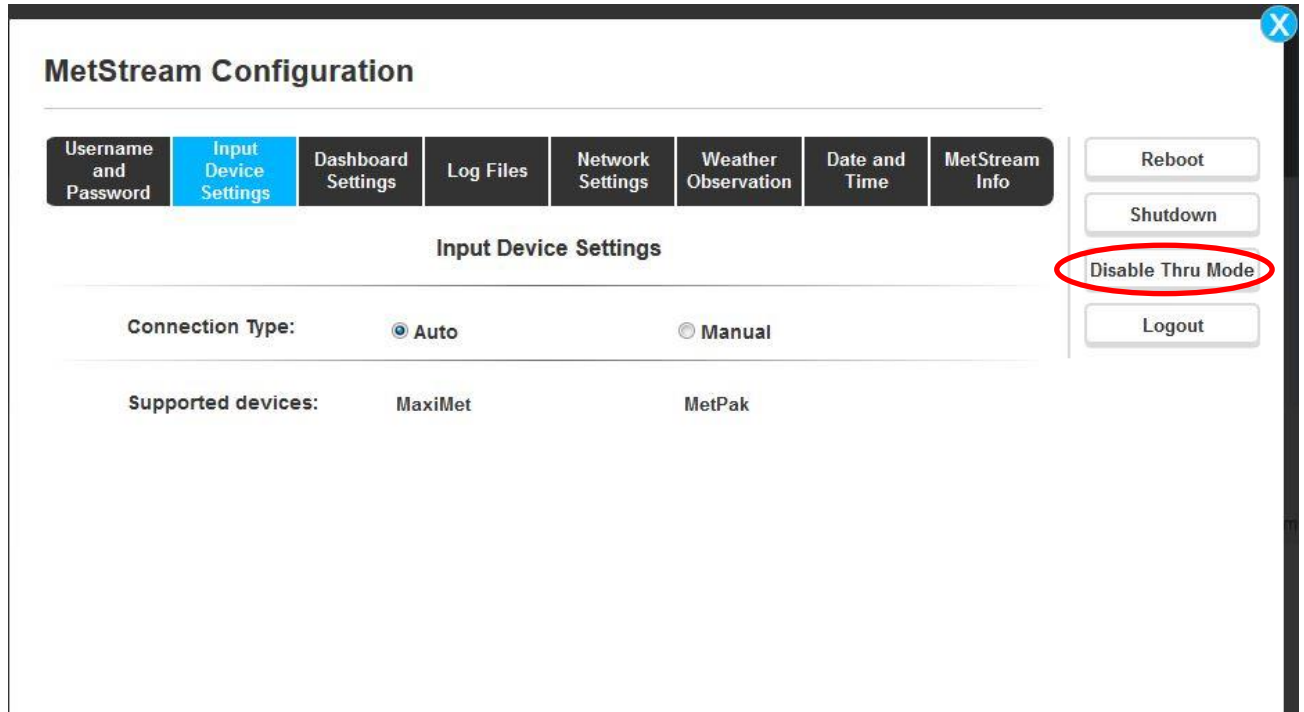

Click on OK.



MetStream will now Re-Boot.

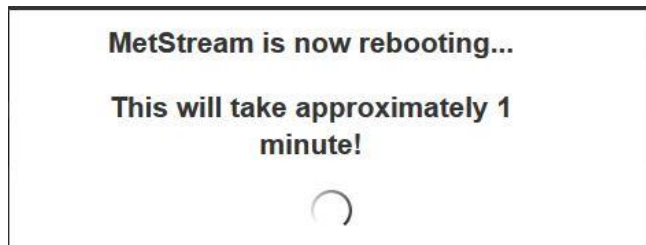

After 1 minute Refresh the Web Browser IP address page to view normal connected instrument data.

6.5.13 Port Forwarding

If the router/server that the MetStream is linked to is connected to the internet, it will have a Public IP Address. This is assigned by the Internet Service Provider (ISP) and more often than not it isn't fixed. If a fixed IP address is required a fee usually has to be paid to the ISP.

If this IP address (fixed or not) is known then it is possible to access the MetStream browser page from outside of the subnet that the MetStream is connected to.

The router/server will have a different sub network set of addresses from its external address. For example; its subnet may be 192.168.1.XXX (any device connected to the router like PC's, tablets & the MetStream would see this subnet) and its external IP (this is the address that any device on the internet side of the router/server would see when they try to connect) may be 4.85.161.114 (this address would be assigned by the ISP).

Therefore, to connect to the MetStream from outside the subnet, a port forwarding rule would need to be setup on the router (the exact method varies from router to router). By default, the MetStreams web server port is set to 80. If, in this example, it is assumed that the routers subnet is 192.168.1.XXX and therefore the MetStreams IP is fixed at 192.168.1.99 (details of how to do this can be found in the manual) and the routers external IP has been fixed at 4.85.161.114, then a rule would need to be setup in the router that means that typing the address & port 4.85.161.114:80 from outside of the routers subnet would be directed through to the MetStreams web page.

As port 80 is the port used by any device that serves up a web page, it would be advisable when attempting to setup a port forwarding rule for the MetStream to change this port to prevent possible conflict. Details on how to do this can be found in Para 6.5.7.

7. MAINTENANCE & FAULT-FINDING

7.1 Maintenance

There are no MetStream user-serviceable parts requiring routine maintenance.

Opening the unit will void the warranty.

In the event of failure, prior to returning the unit to your authorised Gill distributor, it is recommended that:

- All cables and connectors are checked for continuity, bad contacts, corrosion etc.
- Fault-finding checks are carried out as Para 7.2.
- Contact your supplier for advice if failure persists.

7.2 Fault-finding

To Support fault finding Gill Instruments Manuals can be downloaded from:-
<http://www.gillinstruments.com/data/manuals/manuals.htm>

Gill Instruments Software can be downloaded from:-
<http://www.gillinstruments.com/main/software.html>

Symptom	Action
Not able to open the GUI Display	<ul style="list-style-type: none"> • Check DC power is applied to the MetStream, the front panel Yellow LED should be constantly illuminated. • If the MetStream front panel Green LED is flashing then check the cabling between the connecting instrument and MetStream. • Check that there is a link between the MetStream 8 way connector terminals 6 (Power Enable) and 7 (0v). This supplies power to the connected instrument. • Check the MetStream Ethernet cable socket connection between MetStream the PC/Router/LAN. The Green LED should be constantly illuminated and the Yellow LED will flash showing data traffic. • Check that correct Ethernet cable type has been used (straight or crossover as appropriate). • Check that the correct IP address has been used. • Connect MetStream directly to a PC as detailed in Paras 6.1.1.or 6.1.2 and use IP address 192.168.67.67 to check MetStream operation and configuration.
Corrupted output	<ul style="list-style-type: none"> • Check cable lengths and type of cable. • Check connected instrument is installed as per its installation guidelines to avoid sources of interference.
MetStream GUI opens but does not display the connected instrument	<ul style="list-style-type: none"> • If the MetStream front panel Green LED is flashing then check the cabling between the connecting instrument and MetStream. • Check that there is a link between the MetStream 8 way connector terminals 6 (power Enable) and 7 (0v). • Is the unit set for Thru Mode? Disable Thru Mode (see para 7.2.1). • Use Thru Mode (see para 7.2.1) to check communication with the connected sensor.
Incorrect GUI.	<ul style="list-style-type: none"> • Clear the Web Browser cache.

7.3 Returning Units

If the unit has to be returned, it should be carefully packed in the original packaging and returned to your authorised Gill distributor, with a full description of the fault condition.

Gill Instruments Distributors can be found at:-

http://www.gillinstruments.com/main/an_distributors.htm

The Return Maintenance Authorisation (RMA) procedure can be found at:-

<http://www.gillinstruments.com/products/anemometer/support.htm>

8. APPENDICES

8.1 Glossary & Abbreviations

Item	Meaning
BS	British Standard
CAT	Category
CFR	Code of Federal Regulations
CSV	Comma Separated Variable
DC	Direct Current
DHCP	Dynamic Name Host Protocol
DNS	Domain Name System
EC	European Community
EMC	Electro Magnetic Compatibility
EN	European Standard
FCC	Federal Communications Commission
GND	Ground
GUI	Graphical User Interface
IEEE	Institute of Electrical and Electronic Engineers
IP	Internet Protocol or Ingress Protection
LAN	Local Area Network
LED	Light Emitting Diode
MAC	Media Access Control
MAX	Maximum
MIN	Minimum
No.	Number
O/P	Output
NTP	Network Time Protocol
PC	Personal Computer
POE	Power over Ethernet
PTP	Precision Time Protocol
RJ	Registered Jack
RMA	Return Material Authorisation
RS232	Communications standard

Item	Meaning
RS422	Communications standard
RS485	Communications standard
RX	Receive
RXD	Received Data
SD	Secure Digital
STP	Shielded Twisted Pair
TCP	Transmission Control Protocol
TX	Transmit
TXD	Transmitted Data
TXT	Text
UL	Underwriters Laboratory
USB	Universal Serial Bus
UTP	Unshielded Twisted Pair
WLAN	Wireless Local Area Network
WOW	Weather Observation Website
+VE	Positive
-VE	Negative

8.2 Guarantee

For terms of guarantee contact your supplier or refer to the Gill Instruments Terms & Conditions here:

<https://gill.group/wp-content/uploads/Gill-Group-Company-Terms-Conditions-of-Sale-9170-0003-Issue-02-March-20..pdf>

Warranty is void if the black security seal covering MetStream box screws are damaged or broken.

9. FCC

MetStream complies with part 15 of the FCC Rules. Operation is subject to the following two conditions:-

- (1) This device may not cause harmful interference, and
- (2) This device must accept any interference received, including interference that may cause undesired operation.”

This equipment has been tested and found to comply with the limits for a Class A digital device, pursuant to part 15 of the FCC Rules. These limits are designed to provide reasonable protection against harmful interference when the equipment is operated in a commercial environment. This equipment generates, uses, and can radiate radio frequency energy and, if not installed and used in accordance with the instruction manual, may cause harmful interference to radio communications. Operation of this equipment in a residential area is likely to cause harmful interference in which case the user will be required to correct the interference at his own expense.