



METER

AQUALAB® VSA

TABLE OF CONTENTS

1. Introduction.....	1
2. About the VSA.....	2
2.1 Moisture Sorption Isotherms	2
2.2 Measurement Method.....	3
2.3 Specifications.....	4
2.4 User Interface and Menus	5
2.4.1 Isotherm Tab	6
2.4.2 Measurement Tab	7
2.4.3 Configuration Tab.....	7
2.4.4 Data Tab	15
3. Theory.....	18
3.1 Combining DVS and DDI in One Instrument	19
3.2 Hysteresis.....	20
3.3 Nonequilibrium.....	22
3.4 Matrix Changes	22
3.5 Working Isotherms.....	23
3.6 Isotherm Models.....	24
3.7 Uses for Moisture Sorption Isotherms	25
4. Installation.....	27
5. Cleaning and Maintenance	31
5.1 Desiccant Replacement.....	31
5.2 Sample Chamber Cleaning.....	34

5.2.1	Cleaning Kit	34
5.2.2	Cleaning Procedure.....	35
5.3	Capacitance Filter Replacement.....	36
5.4	Maintenance Packages	37
6.	Verification and Calibration.....	38
6.1	Water Activity Verification	38
6.1.1	Verification Standards	38
6.1.2	Verification of Calibration	39
6.2	Linear Offset	41
6.3	Adjusting for Weight Measurement Offset.....	42
6.4	Restore Factory Defaults	43
6.5	Isotherm Standard Comparison	44
7.	Running a Test	46
7.1	Becoming Familiar with Stages.....	46
7.2	Moisture Analysis Toolkit Software.....	46
7.3	Running a Moisture Sorption Isotherm Test	46
7.4	Using DDI to Investigate Glass Transition	53
7.5	Creating a Working Isotherm	53
7.6	Editing a Running Isotherm Test	54
7.7	Running a Water Activity Test	55
8.	Sample Preparation	56
8.1	Coated and Dried Samples.....	57
8.2	Low Water-Emitting Samples	57
8.3	Volatile Samples	58
8.4	Low Water Activity	58

9. Service	59
9.1 Troubleshooting.....	59
9.2 Customer Support.....	64
9.3 Repair	65
9.4 Terms and Conditions	65
Index	67

1. INTRODUCTION

Thank you for choosing the AQUALAB Vapor Sorption Analyzer (VSA) from METER Group. The VSA is an automatic isotherm generator from the world leaders in water activity measurement. The VSA is the only automatic isotherm generator that can generate isotherms using both the Dynamic Vapor Sorption (DVS) method, which generates equilibrium isotherms, and the Dynamic Dew Point Isotherm (DDI) method, which generates dynamic isotherms. By combining both methods in one instrument, the VSA makes it possible to investigate both dynamic matrix changes due to water sorption and the kinetics of those changes. This manual details VSA operation and provides information on the capabilities of the VSA.

This manual includes instructions for setting up your VSA which includes setting up an isotherm test, running a test, collecting data, and analyzing data. Please read the manual before operating the VSA to ensure the instrument performs to its full potential.

METER provides this manual to aid the end user in understanding the basic concepts of moisture sorption isotherms, enabling them to use our instruments with confidence. METER has made every effort to ensure the content of this manual is correct and scientifically sound.

Verify all VSA components are included and appear in good condition:

- AQUALAB VSA Isotherm Generator main unit
- Calibration certificate
- Power cord
- USB cable
- 2 stainless steel sample cups
- 3 refillable desiccant tubes
- 2 bottles (1 for water; 1 for air)
- AQUALAB Cleaning Kit
- Three vials each of the following verification standards solutions:
 - 0.920 a_w 2.33 mol/kg NaCl
 - 0.760 a_w 6.00 mol/kg NaCl
 - 0.500 a_w 8.57 mol/kg LiCl
 - 0.250 a_w 13.41 mol/kg LiCl
- Moisture Analysis Toolkit Software Package with registration key
- 1 2-g NIST traceable weight
- Tweezers

NOTE: Please keep your original instrument shipping box. If the VSA needs to be returned to METER, it must be shipped in the original packaging.

2. ABOUT THE VSA

The VSA Isotherm Generator is an automatic moisture sorption isotherm generator that can generate both dynamic and equilibrium moisture sorption isotherms.

2.1 MOISTURE SORPTION ISOTHERMS

A moisture sorption isotherm defines the relationship between water activity (a_w) and moisture content at a given temperature. This relationship is complex and unique for each product due to different interactions (colligative, capillary, and surface effects) between the water and the solid components at different moisture contents. An increase in a_w almost always accompanies an increase in water content, but in a nonlinear fashion. Moisture sorption isotherms are sigmoidal in shape for most foods, although foods that contain large amounts of sugar or small soluble molecules have a J-type isotherm curve shape.

Isotherms provide information about product quality and safety. A few uses for isotherms include:

1. Monolayer moisture content determination.
2. Determine critical water activity or moisture content.
3. Limits for crispness, hardness, and flow properties.
4. Optimize moisture contents at a safe water activity that maximizes moisture and avoids over drying.
5. Determine shelf-life and storage stability of a product.
6. Predict packaging requirements based on sorption properties of a product.
7. Determine kinetics of sorption and water vapor diffusion coefficients
8. Determine the equilibrium water activity of a mixture of dry ingredients.
9. Determine the degree of crystallinity of powders.
10. Determine the level of amorphous material in a product.
11. Determine critical water activities for phase transitions.
12. Determine the relationship between water activity and glass transition temperature.
13. Determine the relationship between water activity and crystallization.
14. Determine hysteresis levels for a product.
15. Determine the moisture sensitivity of a product.
16. Determine the equilibrium moisture content at a given water activity.
17. Allow rapid moisture content determination from water activity analysis through an isotherm curve.

2.2 MEASUREMENT METHOD

The VSA is the only automatic isotherm generator that can create isotherms using both dynamic and static methods. The VSA uses the Dynamic Dew Point Isotherm (DDI) method to produce dynamic isotherms and a controlled humidity and balance system, commonly referred to as Dynamic Vapor Sorption (DVS), to produce static or equilibrium isotherms.

The DDI method for dynamic isotherms is a water activity and gravimetric analysis method that controls neither water content nor water activity, but dries or wets the sample and measures water activity and water content during the wetting or drying process. The VSA determines water content by weighing the sample using a high precision magnetic force balance and water activity with METER's patented chilled-mirror dew point sensor. The VSA imposes drying of the sample by flowing dry air from a desiccant tube across the sample and wetting of the sample by saturating the air with water before it enters the chamber to flow across the sample. The VSA water reservoir mounts to the temperature controlled lower block to ensure humidity saturation and minimize temperature fluctuation.

The DVS method for static or equilibrium isotherms consists of tracking sample weight change as the sample is exposed to different controlled humidities. The sample is held at each humidity for a preset time interval or until a steady state weight change is achieved, the goal being to achieve equilibrium between the sample water activity and the controlled humidity. Customers typically choose several humidity levels to preset during the set up process. The instrument then tracks equilibrium progress at each humidity level and automatically steps to the next humidity when equilibrium requirements are achieved. Weight change versus time data is recorded allowing for determining kinetics of sorption for each humidity level. Using less stringent equilibrium settings for weight change or setting a reduced time interval at each step can speed up the isotherm test, but may give nonequilibrium results. In addition, setting smaller steps in humidity increase the data resolution of the isotherm, but at the expense of much longer test times.

The VSA is a stand-alone instrument with an integrated pump system that eliminates the need for an external gas cylinder, however you can use an external gas source if desired. The instrument consists of a case which houses the power supply, air pump, balance, temperature controlled sample chamber, sensor block, sensor and temperature control electronics, water reservoir, and desiccant supply. Setup is as simple as plugging the instrument in, installing the desiccant tubes, and filling the water reservoir. Test parameters can be set using an on-board interface or using a connected computer and VSA software package.

2.3 SPECIFICATIONS

MEASUREMENT SPECIFICATIONS

Water Activity

Range	0.030–0.95 a_w (3%–95% RH)
Resolution	0.0001 a_w (0.01% RH) ±0.001 a_w (0.1% RH) for volatiles setting
Accuracy	±0.005 at 25 °C

Temperature

Range	15–50 °C
Resolution	0.01 °C
Accuracy	±0.1 °C
Adjustment Increment	1 °C

Read Time

~5 min

Isotherm Methods

Dynamic Dew Point Isotherm (DDI) and Static (DVS)

External Gas

7 psi max

Mass Resolution

0.5 mg

PHYSICAL SPECIFICATIONS

Case Dimensions

Length	38.1 cm (15.0 in)
Width	26.7 cm (10.5 in)
Height	30.5 cm (12.0 in)

Case Material

POLYLAC PA-765 (ABS) with fire retardant

Sample Cup Capacity

14 mL (0.47 fl oz)

Weight

14.9 kg (33.0 lb)

Display

64 × 128 graphical

Operating Temperature

Minimum	4 °C
---------	------

Typical	23 °C
---------	-------

Maximum	50 °C
---------	-------

Operating Environment

0%–90% RH noncondensing

Data Communications

USB

Power

110–220 VAC 50/60 Hz

COMPLIANCE









Manufactured under ISO 9001:2015

EM ISO/IEC 17050:2010 (CE Mark)

2.4 USER INTERFACE AND MENUS

The AQUALAB VSA is a standalone instrument with arrows and three buttons useful for navigating menus and beginning tests. There are four tabs at the top of the display screen, the Isotherm, Measurement, Configuration, and Data tabs. These tabs indicate the four menus. The button icons on the display change to show the available actions for the screen (Table 1).

Table 1 AQUALAB VSA button icons

Icon	Name	Action
	Enter	Accepts the current action
	CANCEL	Ends the current action
	MENU	Switches between the Isotherm, Measurement, Configuration, and Data tabs
	SAVE	Saves a setting or a reading
	OK	Accepts the input from the user
	GRAPH	Shows graph view
	WIZARD	Brings up Test Setup Wizard
	AUDIO OFF	Silences beeping
	AUDIO ON	Enables beeping

2.4.1 ISOTHERM TAB

The Isotherm tab is the main screen and displays each time the VSA turns on. If the Isotherm tab screen does not appear, refer to [Section 9.1](#) for troubleshooting. Operators can initiate a new test from this screen by pressing the wizard icon (third button from right). If a test is already running, this screen displays the latest test values including water activity, weight or % moisture content and temperature. Pressing the second button activates the chart view.



Figure 1 Isotherm tab

2.4.2 MEASUREMENT TAB

The Measurement tab allows you to take water activity readings of the sample in the sample chamber when not running a test. Pushing the right or left arrow keys changes the display to a temperature equilibration screen that shows the temperature difference between the sample temperature and the lid temperature.



Figure 2 Measurement tab

2.4.3 CONFIGURATION TAB

The Configuration tab allows the operator to view various configuration options. Pressing the up and down arrows moves through the configuration options, while pressing the right and left arrows allow the operator to page through the options.

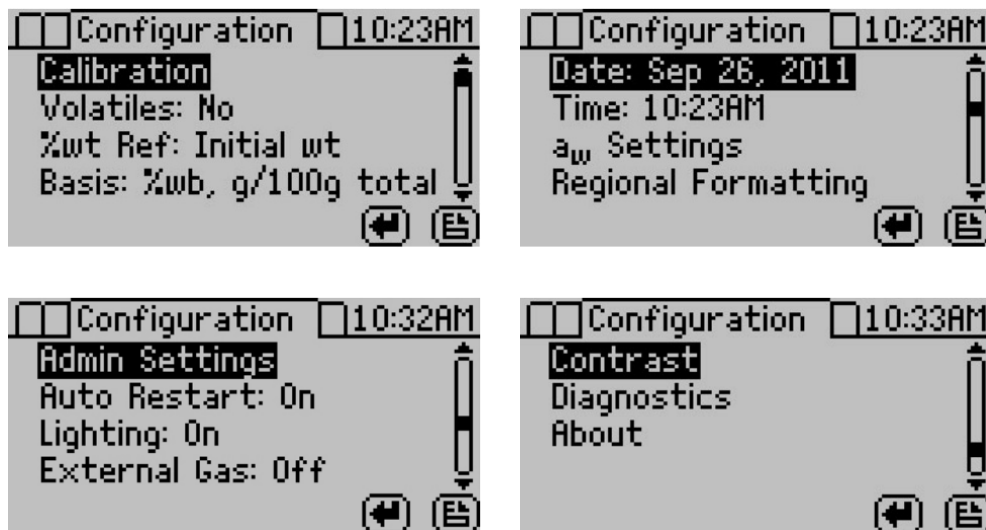

Figure 3 Configuration tab menu

2.4.3.1 CALIBRATION

Highlight “Calibration” and press the **Enter** button to open the Calibration menu where you can make either a water activity or weight adjustment.

For more details on weight and water activity calibration procedures refer to [Section 6](#). You may also reset the calibration to the factory defaults by highlighting the Defaults option in the calibration menu and pressing **Enter**.

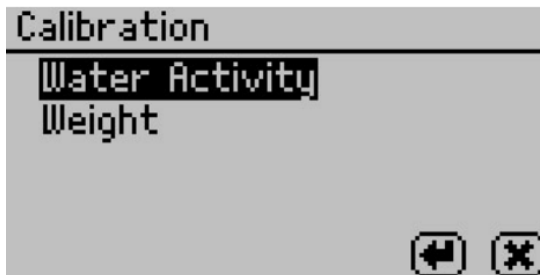

Figure 4 Calibration option

2.4.3.2 VOLATILES

The instrument gives accurate readings on most samples when the default volatiles setting is “Off.” When reading with volatiles off the chilled mirror method is used by default. However, samples with certain volatiles in high enough concentrations may give inaccurate water activity values. This is because the volatiles condense on the mirror during the reading process, but do not evaporate from the mirror as water does. The concentration of volatiles that causes interference is variable and matrix dependent.

The most effective method to determine if volatiles are a problem is to compare dew point readings to capacitance readings. If the dew point readings are more than 0.02 higher than the capacitance readings, volatiles are likely a problem and it is recommended that the volatiles setting be switched to On. When you turn the volatiles setting on, the instrument only uses the capacitive relative humidity sensor for water activities measurements and isotherm tests. All other operations and features are the same, including measurement times and adjusting for linear offset. Press **Enter** to toggle the volatiles setting on and off.

2.4.3.3 WEIGHT REFERENCE

Weight reference is the reference used when calculating the percent change in weight of the sample. This can be based on the initial weight of the test, the starting weight of the stage or the minimum weight during the test. Use this reference anytime you are calculating a percent weight.

2.4.3.4 BASIS

The VSA generates water activity values and corresponding sample weights during moisture desorption and resorption. To complete the isotherm, the sample weights must be translated into moisture contents. Moisture content can be calculated in different ways and reported with a variety of different units. The basis parameter allows the reporting of moisture content in two different ways, percent moisture on a wet basis and percent moisture on a dry basis.

Percent Moisture on a Wet Basis (%wb, g/100g total)

$$\% \text{Moisture} = \frac{\text{initial weight} - \text{final weight}}{\text{initial weight}} \times 100 = \frac{\text{grams of water}}{100 \text{ grams total}} \quad \text{Equation 1}$$

Percent Moisture on a Dry Basis (%db, g/100g solids)

$$\% \text{Moisture} = \frac{\text{initial weight} - \text{final weight}}{\text{final weight}} \times 100 = \frac{\text{grams of water}}{100 \text{ grams total}} \quad \text{Equation 2}$$

For food applications, moisture contents are reported on a wet basis.

A simple equation converts between the wet and dry basis.

$$\% \text{moisture dry} = \frac{\% \text{moisture wet}}{100 - \% \text{moisture wet}} \times 100 \quad \text{Equation 3}$$

$$\% \text{moisture wet} = \frac{\% \text{moisture dry}}{100 + \% \text{moisture dry}} \times 100 \quad \text{Equation 4}$$

2.4.3.5 DATE

The VSA has an internal calendar and clock that allow it to record the time and date of each water activity reading. Press **Enter** with the Date option highlighted to set the date in the instrument. Press the left and right arrows to change between the month, day and year. Press the up or down arrows to change any of the individual values.



Figure 5 Date screen

2.4.3.6 TIME

Pressing **Enter** with the Time option highlighted allows you to set the current local time. Press the up or down arrows to change any of the individual values. Press the left or right buttons to change between hour and minutes. The hour setting automatically changes between AM and PM.

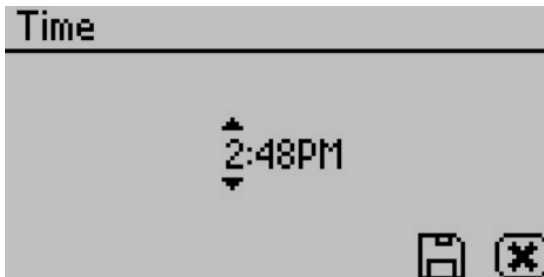

Figure 6 Time screen

2.4.3.7 a_w SETTINGS

Settings related to water activity measurements can be updated here. These include default system temperature, temperature equilibration tolerance, and beeps.



Figure 7 a_w Settings screen

2.4.3.8 TEMPERATURE

This setting determines the temperature that the instrument maintains during water activity measurements. It is also the temperature that the instrument returns to after completing a test. The default temperature is 25 °C. Press the **Enter** button to change the temperature setting. You can set the VSA anywhere between 15 and 60 °C in 0.1 °C intervals. Use the up and down arrows to set the VSA to your desired temperature.

2.4.3.9 TEMPEQ

Temperature Equilibration Tolerance or “Temp Eq” sets the maximum difference allowed between the lid and the sample. This lid to sample temperature difference must be less than the Temp Eq in order to start a water activity measurement. If a sample is out of this range, the VSA waits for the sample to equilibrate prior to beginning the water activity measurement. 4 °C is the default setting.

2.4.3.10 BEEPS

Indicates the number of audible beeps after a water activity measurement is completed. You can set this value to off (0), 4, or infinity (∞).

2.4.3.11 REGIONAL FORMATTING

Allows you to configure how the VSA displays information. You may choose the temperature scale (Celsius vs Fahrenheit), the date display (mm/dd/yy vs. dd/mm/yy), the hour format (12 vs 24 hour) and the language. Press **Enter** to switch the setting.

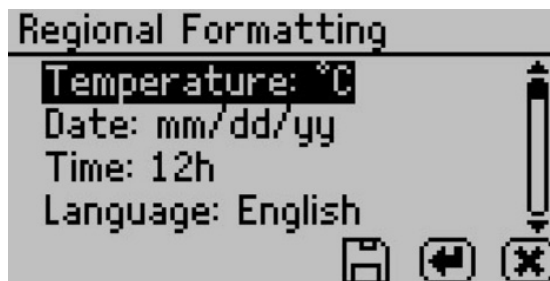

Figure 8 Regional formatting screen

2.4.3.12 ADMIN SETTINGS

Allows you to create an administrator password as well as add, edit and delete additional users. The Admin option allows the administrator to grant or block access to some or all of the configuration options.

For example, if the administrator wanted to make sure that all samples were read at 25 °C the administrator would set their temperature to 25 °C and then would lock all other users out of that Configuration screen. This is accomplished by entering the Access function and selecting the desired option to toggle it on and off. Additionally you can lock and unlock all of them at once. (For example, if you do not want an individual changing the instrument measurement temperature, the administrator can lock that function for that individual.) Administrators can lock the calibration, temperature, temperature equilibration, sensor selection, mode, date/time, region, password, autosave, number of beeps, contrast, and delete functions.

2.4.3.13 USER SETUP

Users can be added, edited or deleted from this screen. To add a user, press the **Enter** button with the “New” highlighted. To edit or delete a user, choose the target user and press **Enter**. When creating a new user, an alphabet screen appears where you can enter a name using lower case, upper case and accents.

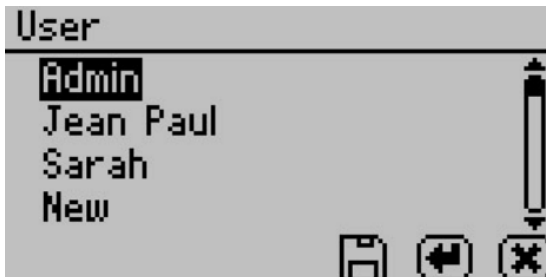

Figure 9 User screen

NOTE: User setup is not required for instrument operation. It is available for users wanting to be compliant with 21 CFR Part 11 or who want to maintain the settings they have selected.

2.4.3.14 AUTO RESTART

Auto restart enables the instrument to automatically resume the currently running test if there is a power failure of any kind. Press **Enter** to toggle auto restart between on and off. METER recommends this be set to on to prevent data loss. Note: Restart tests with a new sample if power outages last more than 30 minutes.

2.4.3.15 LIGHTING

Turns the lighting in the desiccant tube area on or off.

2.4.3.16 EXTERNAL GAS

Enables or disables the use of external gas. When External Gas is On, the external gas serves as the air source for sample desiccation and wetting. When External Gas is Off the internal pump uses ambient air as the air source.

NOTE: When you use the external gas, it exhausts into the atmosphere. Be sure to provide adequate ventilation and safety measures while using an external gas supply with the instrument. Do not use combustible or hazardous gases.

To turn external gas on, highlight “External Gas: Off” and press **Enter**. The External Gas screen appears.

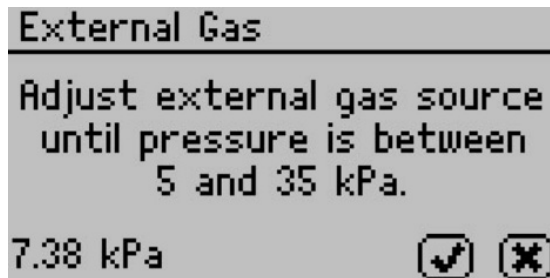

Figure 10 External Gas screen to turn on gas

To start using external gas, remove the external gas plug from the back of the VSA and insert the desired gas source. Adjust the external gas pressure until it is between 5 and 35 kPa (0.7 to 5 psi). The VSA hides the Check Mark until the gas is within the acceptable pressure range. Press the Check Mark to enable external gas or escape to cancel.

NOTE: When selecting a gas source, choose a gas supply with a filter system that eliminates oil and other particulates to help prolong the life of your VSA. Make sure to keep the external gas plug to use when you remove the external gas source.

If the external gas is turned on in the Configuration tab and you want to turn it off, pressing **Enter** causes the External Gas screen to appear.

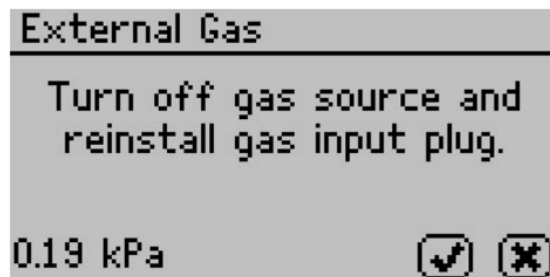

Figure 11 External Gas screen to turn off gas

To stop using external gas, turn off the external gas source and remove the external gas tubing and adapters from the back of the instrument. Reinstall the external gas plug and then press the Check Mark to disable external gas or the X to return to the Configuration tab without changing the setting.

2.4.3.17 CONTRAST

Allows adjustment to the screen contrast. Viewing the screen from a sitting versus a standing position may require contrast adjustment for the best visibility in that position.

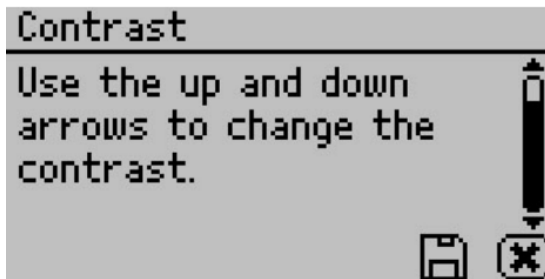

Figure 12 External Gas screen to turn off gas

2.4.3.18 DIAGNOSTICS

The Diagnostics screen provides you with detailed information about all the sensors in the instrument. Refer to [Section 9.1](#) for details on what kind of values you should expect for each sensor. Press up or down to page between the different Diagnostics screens.

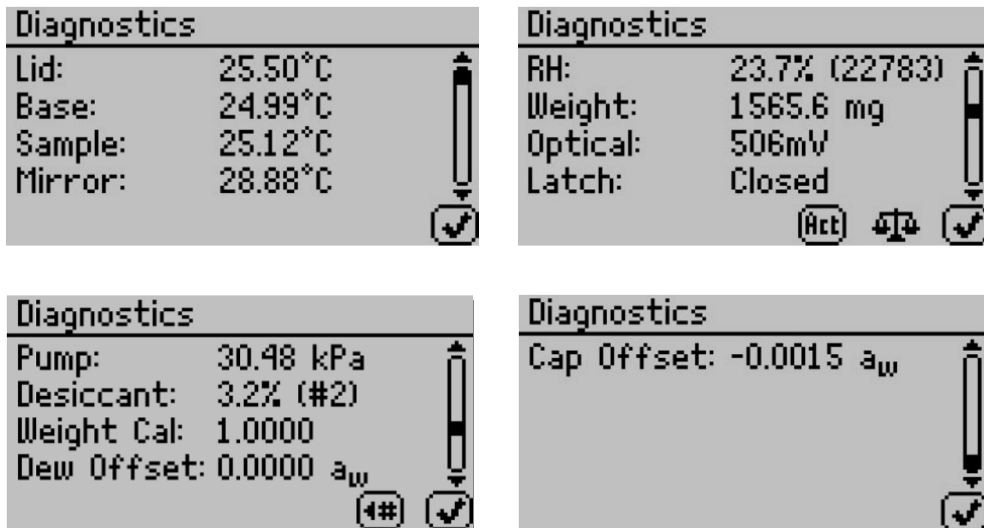

Figure 13 Diagnostics screen menu

The scale icon on the bottom of the second screen allows you to zero the balance so that you can take weight readings via the diagnostic screen. The icon labeled “Act” toggles the actuator system on and off. With the lid open, pressing this button causes the weigh pan and actuator cylinder to alternatively rise and fall if working properly.

On startup, the pump is turned on and flows dry air into the chamber to monitor the desiccating capacity of the tubes. The number button on the bottom screen allows you to switch between the two desiccant tubes. If you press the number button with the arrow

to the left, it switches to the left desiccant tube (#1). If you press the number button with the arrow to the right, it switches to the right desiccant tube (#2). Any time you press the desiccant tube button, the pump turns on and blows dry air into the chamber to monitor the desiccating capacity of the tubes.

The weight calibration value is the current calibration applied to balance readings. A value of one means no weight calibration is applied. The dew point and capacitance RH sensor offset values are the current linear offsets applied to water activity readings for the respective sensor type. A value of zero means that the VSA applied no water activity offset.

2.4.3.19 ABOUT

The About screen provides important information including the serial number and firmware code version of your instrument.

2.4.4 DATA TAB

The Data tab allows you to view detailed information about the test stored in the memory. You can view data as a list, view detailed data point information, and graph all or individual stages. You can also delete the data in the memory.

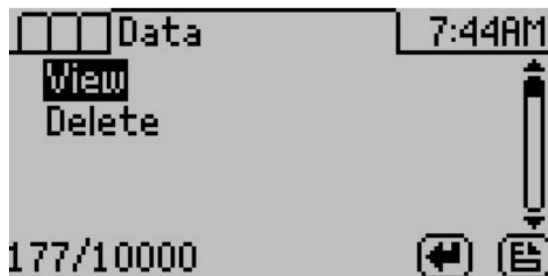

Figure 14 Data tab

2.4.4.1 VIEW

This selection brings you to a screen where you can decide how to view the data. View the whole test at once by selecting All or view an individual stage. Once the desired portion of the test is selected, choose to graph the data by pressing the graph icon or press the **Enter** icon to view summary information of each data record. Use the Moisture Analysis Toolkit to download test data to a computer ([Section 7.2](#)).

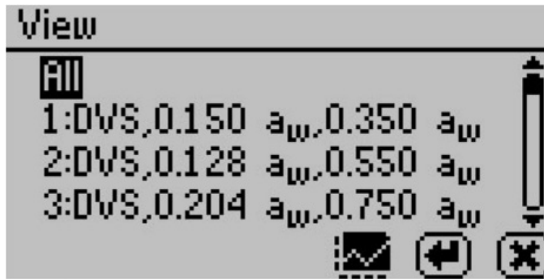

Figure 15 View data screen

GRAPH SCREEN

This selection shows a graph of the selected data from the previous screen. Press the directional arrows to change the y or x-axis units. The title of this graph indicates the test name, stage number (if applicable), and the isotherm type is on the right.

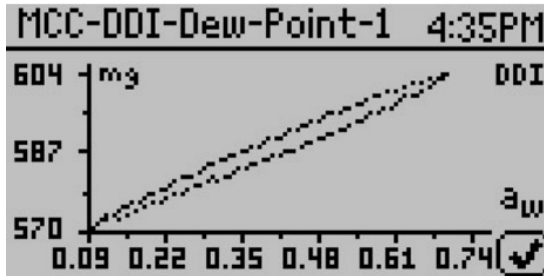

Figure 16 Example of a graph with water activity as the x-axis

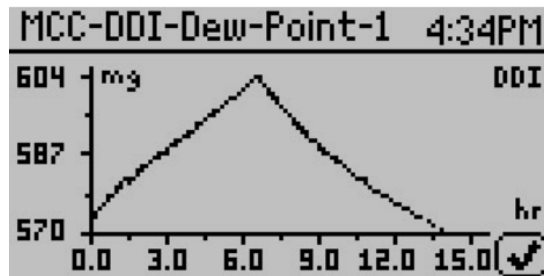

Figure 17 Example of a graph with elapsed time as the x-axis

NOTE: For DVS isotherms, if water activity is the x-axis, only equilibrated data points appear on the chart. To view all the data points, the x-axis must be in terms of the time elapsed.

SUMMARY SCREEN

This selection allows you to view your stored measurements. The up/down arrows move you through the stored data with the most recent measurements at the top of the table. You may also press the left and right arrows to page quickly through the data. While on the Summary screen, press the **Enter** button on a highlighted reading to get detailed information on the reading in the Data screen.

The information shown is the water activity of the sample, the temperature, the test time, the user who ran the test (if setup), the date of the reading, the sensor used, the time of the reading, and the sequence number of the stored reading.

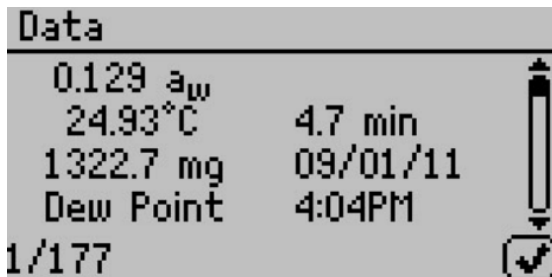

Data	
0.129 a _w	4.7 min
24.93°C	09/01/11
1322.7 mg	4:04PM
Dew Point	
1/177	

Figure 18 Data tab

2.4.4.2 DELETE

Selecting this option deletes all of the information currently stored in the instrument.

NOTE: You are not able to recover deleted data so make sure you have backed up your data to the computer using the Moisture Analysis Toolkit software package prior to deleting the data from the instrument.

3. THEORY

Water profoundly influences product attributes such as quality and safety. To completely understand water relations in a product requires an understanding of the amount of water (moisture content) that can be held at a given energy state (water activity). Moisture sorption isotherms describe the relationship between water activity and moisture content at a constant temperature. The nature of this relationship depends on the interaction between water and other ingredients.

The amount of water vapor that a product has depends on the chemical composition, physical-chemical state, and physical structure of the product. Consequently, the isotherm shape is unique to each product type due to differences in capillary, surface, and colligative effects (Figure 19). Products that lie in the low water activity portion of the isotherm are often referred to as dry, those in the range of 0.60 a_w to 0.90 a_w are intermediate moisture products, and those having water activities higher than 0.90 are high water activity products.

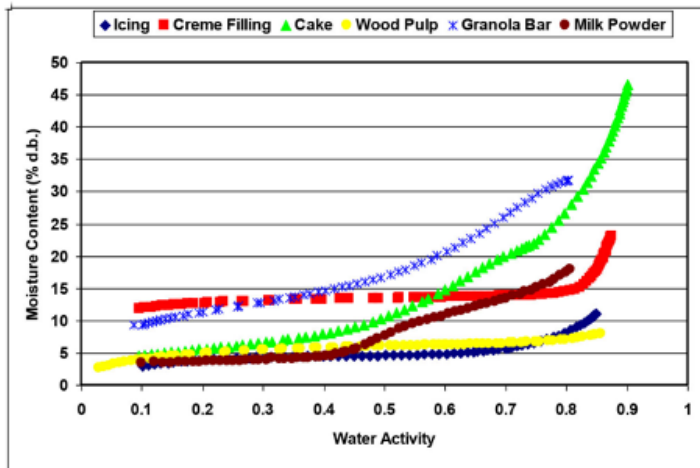

Figure 19 Moisture adsorption isotherms

For ease of interpretation, isotherms are often identified by Brunauer classifications (Brunauer, 1945). Most food and pharmaceutical products fall under type I, II, or III. Type I isotherms are typical of very hygroscopic materials. Type II (sigmoidal) isotherms are typical for intermediate moisture products. Type III (J-shaped) isotherms are typical for crystalline and coated materials. These general classifications proved useful when isotherms on every product was not feasible due to time and labor constraints. However, with automation and improved speed, isotherms can easily be conducted on any product and the uniqueness of each isotherm often proves more valuable than placing them in a common classification.

Constructing an isotherm consists of collecting water activity and moisture content data at various points along the water activity range. The range of water activities you use often depends on the situation, but normally run from 0.10 a_w up to 0.90 a_w . You can run the range of a_w by controlling water activity levels using saturated salt slurries or mechanical

humidifiers and determining equilibrium moisture content at each water activity level. Equilibrium is assumed when the weight of the sample stops changing. This process is often accomplished using sealed chambers such as desiccators and the equilibration process can take weeks. There are several additional challenges to executing this manual method. Tracking the weight of the samples can be difficult. Also when removing the samples for weighing, you potentially expose them to ambient humidity, and at high humidities there is the possibility of mold growth. The METER VSA Isotherm Generator uses the DVS method described above to speed up and automate the construction of equilibrium isotherms, eliminating the challenges of manual determination. In addition to equilibrium moisture contents at a given water activity, equilibrium isotherms provide information about kinetics of sorption and water vapor diffusion properties.

Moisture sorption isotherms can also be determined using dynamic methods such as the DDI method used by the VSA. The DDI method directly measures water activity while gravimetrically tracking weight, so there is no dependence on equilibration to known water activity levels to determine water activity. Adsorption occurs as saturated wet air passes over the sample. Desorption happens as desiccated air passes over the sample. After a short period of time, the VSA halts airflow and takes a snapshot of the sorption process by directly measuring the water activity and weight. The advantages of this method include: increased analysis speed as the sample does not have to wait for equilibration to a known water activity and an unmatched level of resolution. This makes it possible for dynamic isotherms to produce high resolution isotherms in a matter of days instead of the weeks it would take to make a comparable isotherm using equilibrium techniques. The high resolution of dynamic isotherms makes them valuable for observing sudden changes in sorption properties associated with matrix changes such as glass transition.

The dynamic nature of the DDI method means that moisture contents may or may not be at equilibrium and it is possible for there to be differences between dynamic and equilibrium isotherms. For samples with fast vapor diffusion, penetration by water vapor into the whole sample is rapid and isotherms using the DDI method for these types of products are comparable to equilibrium methods. However, for samples with slow diffusion rates, moisture movement through the sample is slow and complete diffusion of moisture into and out of the sample may be slow enough to give the appearance of vapor equilibrium in the headspace during water activity analysis. In reality, the moisture has not had time to be completely absorbed by the sample. Isotherms for these types of samples developed using the DDI method may have lower moisture contents during adsorption and higher moisture contents during desorption than equilibrium isotherms, resulting in higher levels of apparent hysteresis.

3.1 COMBINING DVS AND DDI IN ONE INSTRUMENT

A unique and important feature of the AQUALAB VSA is that it can generate both dynamic and equilibrium isotherms. As explained above, both DVS and DDI methods have advantages and disadvantages. While the data they generate agrees in some cases, it is the uniqueness of the results from each method that gives them value. There is information that can only be obtained from dynamic isotherms such as critical water activities for glass transition. Similarly, there is information that can only be obtained by equilibrium isotherms such

as kinetics of sorption. Therefore, to provide the most information about the moisture characteristics of a material, both types of isotherms are needed. The VSA can provide both DVS and DDI isotherms and even run them both on one sample.

3.2 HYSTERESIS

Figure 20 shows two isotherms, one obtained by wetting a sample from complete dryness and the other obtained by drying a sample from saturation. The arrows show the direction of the process. The water content at each water activity is higher during desorption (drying from high water content) than adsorption (wetting from low water content). This phenomenon is called hysteresis. The curves in Figure 20 represent limits or boundary isotherms since they begin at water activities near zero and one. If a drying process reduces the water activity of a sample only part way to dryness, and the sample is then wet again, it follows a path between the wetting and drying boundary curves, as shown in Figure 21. These curves are called scanning curves, and there can be an infinite number of them depending on where drying stops and starts.

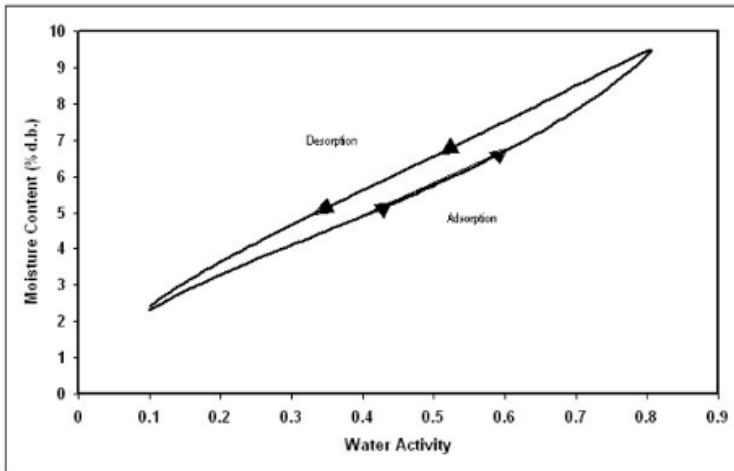

Figure 20 Full isotherm showing hysteresis

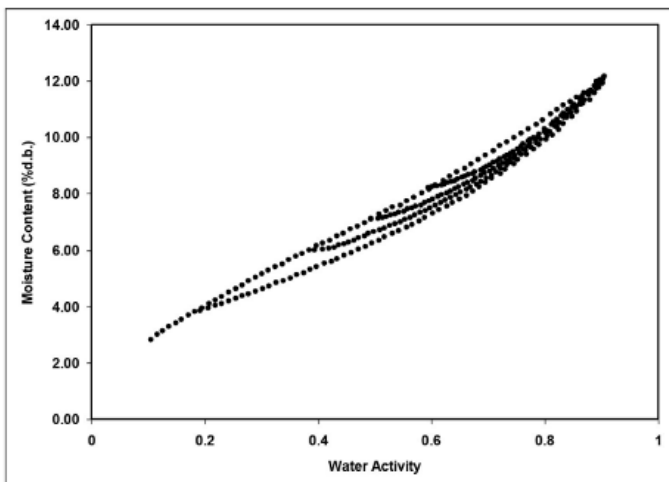

Figure 21 Scanning adsorption Curves from drying to varying a_w

These observations help clarify the point that an isotherm is not a single valued function. The water content for any given water activity value depends on the wetting and drying history of the sample.

It is possible to obtain isotherm data which appears to show hysteresis by failing to allow a sample to equilibrate at each step, or by inducing changes in the water binding properties of the matrix by wetting or drying. Here these cases are treated separately, and the term "hysteresis" is reserved for situations where equilibrium is reached, but water contents of wetted and dried samples still differ because of their history.

There are four primary models for hysteresis. These theories emphasize; capillary condensation of porous solids, phase changes of nonporous solids, structural changes within a solid matrix, and supersaturation of some solutes during desorption. Depending on the composition of the sample, these theories explain why the water content of a desorption process is greater than that for a wetting process.

1. The "ink bottle" model illustrates the capillary condensation of porous solids theory, in which pores and capillaries fill and empty differently. Such a pore fills when the water activity corresponding to the energy state of the larger radius is exceeded, but empties only when the water activity drops below the energy state of the narrow neck radius.
2. A phase change of nonporous solid is illustrated by the fact that desorption from rubbery state can reach equilibrium faster due to increased molecular mobility, while adsorption into a glassy material can be slow due to restrictions in molecular mobility.

3. Structural changes within a solid matrix occur when the material swells and polar sites once obscured are now exposed to bind with water. For example, hydrated protein contains many sites for water “binding” before desorption while dehydrated protein has limited polar sites for water binding prior to adsorption.
4. Some solutes may supersaturate below their crystallization water activity (nonequilibrium condition) and thus, hold more water as a_w declines. Foods with high sugar content frequently exhibit this phenomenon.

3.3 NONEQUILIBRIUM

If diffusion of water into (adsorption) or out of (desorption) a material is slow and you do not allow sufficient time for complete diffusion, then there is probably a large amount of apparent hysteresis that you can reduce by allowing sample equilibration.

3.4 MATRIX CHANGES

Figure 22 shows three different isotherm curves for spray-dried milk powder, each with unique maximum water activities and different sorption histories. The moisture sorption isotherms for spray-dried milk powder show a change in hysteresis due to a phase change at $0.43 a_w$. When the isotherm ends prior to the phase change at $0.43 a_w$ (red square), there is little hysteresis. When the isotherm ends above the phase change (blue diamond), there is apparent, but not actual hysteresis due to the phase change. Subsequent isotherms run on the sample after experiencing a phase transition (green triangle) do not show an inflection point, are repeatable, and exhibit only small levels of hysteresis. The boundary isotherm with a $0.80 a_w$ maximum experienced a phase change at $0.43 a_w$, indicated by a sharp inflection point in the curve. The desorption curve for this isotherm appears to show hysteresis, especially below $0.60 a_w$. However, an isotherm, run on a sample wetted to a maximum water activity below the phase change, exhibits very little hysteresis. The lack of hysteresis in this isotherm indicates that the matrix changes that occur at $0.43 a_w$ are completely responsible for the apparent hysteresis.

Various bonding mechanisms bind water in a sample to particle surfaces. When the configuration of particle surfaces changes due to a phase change, binding sites change and the amount of water which can be bound at a given energy of water also changes. An isotherm curve of the phase changed sample does not show further phase transitions since simply drying the sample does not return it to an amorphous state.

These matrix changes represent a true physical change in the material. They are not reversible by drying, no matter how many drying cycles occur. Differences between the adsorption and desorption curves in the initial isotherm is not true hysteresis since the sample matrix has experienced a physical change. Differences between sorption curves in the subsequent isotherms represent true hysteresis.

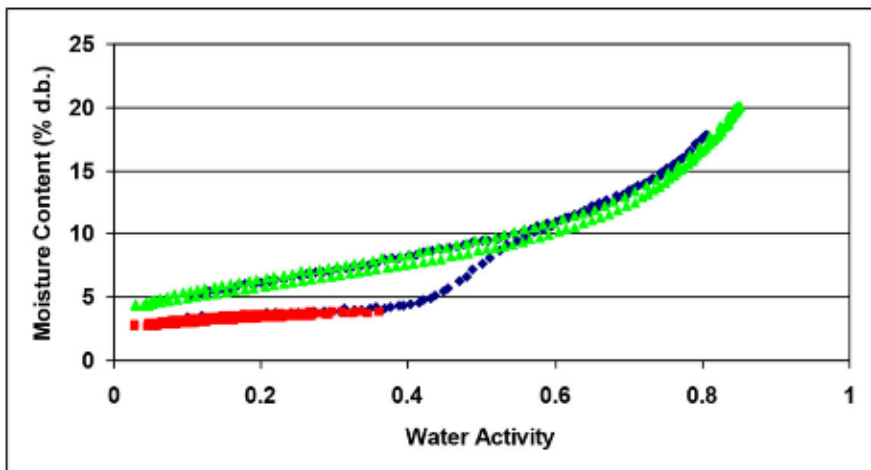

Figure 22 Spray-dried milk moisture sorption isotherms

3.5 WORKING ISOTHERMS

Full boundary isotherms give information about the physical characteristics of a product, show hysteresis, and are important in establishing critical control points, but in many cases a working isotherm proves very useful. A working isotherm shows how a product adsorbs and desorbs water from its current or typical condition. To create a working isotherm, process the product as usual, and then create a scanning curve by wetting one sample from that point and drying a different sample from that same point. Figure 23 shows a working isotherm (blue diamond) superimposed over a full isotherm (red square) for wood pulp. There is a transition from the native starting point ($0.60 a_w$) on the working isotherm in both adsorption and desorption until the curves meet the bounding adsorption and desorption curves of the full isotherm at which point the working isotherm follows the full isotherm.

The scanning curve the product initially follows depends on whether the product was previously wetted or dried to its current state. If you wet a product to a certain water activity and then dry it back down, there is an initial transition period as the product moves from the adsorption curve to the desorption curve. The same is true for a product that you previously dried and then wetted up. There is an initial transition period as the product moves from the desorption curve to the adsorption curve. You can observe this transition region at any point on the isotherm if you change the direction of the sorption and the product exhibits hysteresis. (Figure 23).

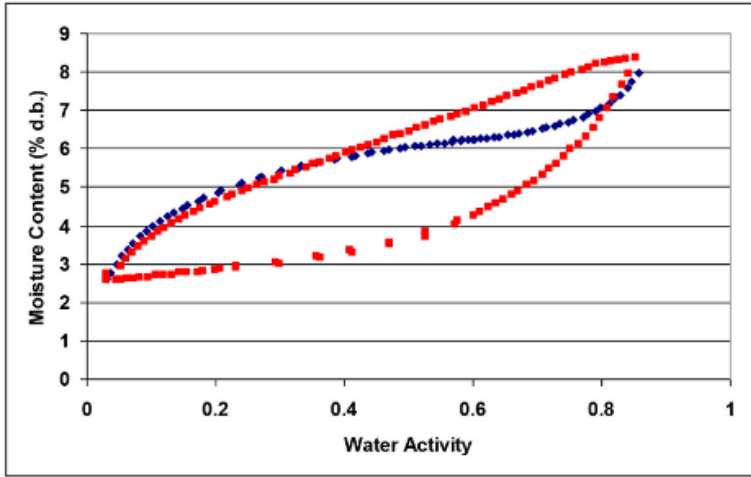

Figure 23 Working and full isotherm for wood pulp

3.6 ISOTHERM MODELS

Several different isotherm models have been proposed and compared in the literature. These models are necessary to predict the moisture content at a given water activity and are used to evaluate thermodynamic functions of water in foods. The models are necessary when using isotherm methods with low data resolution to interpolate between isotherm data points. While there are 270 proposed isotherm models, the most commonly used models are the Guggenheim-Andersen-de Boer (GAB) and Brunauer-Emmett-Teller (BET). Since the BET model is only applicable up to 0.50 a_w , the GAB model is widely accepted as the most useful for characterizing isotherms across the entire water activity range. Its coefficients also have theoretical physical meaning such as providing monolayer moisture content. A new empirical model called the Double Log Polynomial (DLP) or Chi plot has proven to be even better than the GAB at characterizing complex isotherms. The model equations are shown below.

$$\text{BET} \quad m = \frac{a_w m_o c}{(1 - a_w)[1 + a_w(c - 1)]} \quad \text{Equation 5}$$

Where m is the moisture in g/100 solids or g/g solids at water activity a_w and m_o is the monolayer value in the same units. Calculate the constant c with:

$$c = \exp \frac{Q_s}{RT} \quad \text{Equation 6}$$

Where Q_s is the surface interaction energy in J/mole, R is the gas constant (8.314 J/mol K) and $T(K)$ is the temperature.

$$\text{GAB} \quad m = \frac{m_o k_b c a_w}{(1 - k_{ba w})(1 - k_b a_w + k_b c a_w)} \quad \text{Equation 7}$$

Where m is the moisture in g/100 solids or g/g solids, k_b is a constant in the range of 0.70 to 1 and c is a constant in the range of 1 to 2,000. In addition, m_o is the monolayer moisture content in the same units as m and a_w is the water activity at moisture m .

$$\text{DLP} \quad m = b_3\chi^3 + b_2\chi^2 + b_1\chi + b_0 \quad \text{Equation 8}$$

Where m is the moisture in g/100 solids or g/g solids, $\chi = \ln[-\ln(a_w)]$ and $b_0 - b_3$ are empirical constants.

3.7 USES FOR MOISTURE SORPTION ISOTHERMS

Moisture sorption isotherms provide valuable information. For anyone who dries or wets their product, the sorption isotherm serves as a drying and wetting curve that provides information about the moisture content of a product when dried or wetted to a specific water activity. Customers can use the sorption isotherm to assist in process control by determining drying rates and optimal endpoints.

If a product exhibits hysteresis, the isotherm shows what impact the hysteresis has on the moisture content after drying to a given water activity.

An additional function of the isotherm is moisture content prediction. Although water activity is a much better predictor of safety and quality than moisture content, there are times when it is necessary to know both water activity and moisture content as well as the relationship between the two parameters for a given product. Water content measurements can be inaccurate, time-consuming and require a precision balance. As an alternative to moisture content measurement methods, you can use the sorption isotherm to determine moisture content based on water activity, usually with better precision than actually running a moisture content analysis and in much less time.

Customers can utilize isotherms to determine the effect of temperature on water activity and moisture content readings. Isotherms conducted at several different temperatures show the temperature at which a product, in a sealed package (at constant moisture content), is at unstable water activity levels.

Isotherms can be very valuable for formulation and product development. By comparing the isotherms of different formulations, it is possible to determine if a product can be adjusted to allow higher moisture content at a given water activity or a lower water activity at given moisture content. The result can be a moister product that is still shelf stable. For those producing multi-component products, it is possible using the isotherms of the two components to determine the final water activity of the mixture without actually making the product. For dried products, the isotherm predicts the moisture content of the product when it is dried to a shelf stable water activity level.

Finally, sorption isotherms are valuable for shelf life prediction. You can use the product isotherm to determine package requirements depending on the products sensitivity to moisture or to determine the monolayer moisture content, which represents the most stable state of your product. The shape of the isotherm can provide information about the level of amorphous to crystalline material in a product.

THEORY

Changes in the slope of the isotherm indicate phase transitions and can provide information about critical water activities for maintaining texture properties and preventing caking and clumping. You can also determine the water activity value where the glass transition temperature equals storage temperature or the crystallization temperature equals storage temperature.

4. INSTALLATION

Please read all instructions before operating the AQUALAB VSA to ensure the instrument performs to its full potential. Please contact [Customer Support](#) at any time for assistance with installation and setup.

PRECAUTIONS

METER instruments are built to the highest standards, but misuse or neglect may damage the device and possibly void the manufacturer's warranty. Before using the AQUALAB VSA, follow the recommended user instructions and arrange proper protections to safeguard the instrument from damage.

The VSA requires a computer and software to generate and analyze isotherm data. You can disconnect and connect the computer once you begin a test without losing any data.

Follow the steps listed in [Table 2](#) to set up the AQUALAB VSA.

Table 2 Installation

<p>Preparation</p>	<p>Select Clean, Level Location</p> <p>Preserve cleanliness to prevent contamination of the sample chamber.</p> <p>Maintain a level surface to reduce the chance of spilling sample material and contaminating the sample chamber.</p> <p>Select a location where the temperature and humidity remains fairly stable to avoid changes that can affect accuracy (away from air conditioner and heater vents, open windows, etc.). Appendix B provides more details.</p> <p>Select a stable surface free from vibration.</p> <p>NOTE: Always ensure the sample chamber is empty prior to moving the instrument.</p>
<p>Installation</p>	<p>Level the Instrument</p> <p>Use the bubble level and the three adjustable feet to level the VSA.</p> <p>NOTE: The small rubber feet on the back of the lower plate prevent tip-over and do not need to be touching the table.</p>  <p>The diagram shows a close-up of the instrument's base. A red bubble level is mounted on the lower plate. Below the plate, there are three adjustable feet: two on the front and one on the middle back. Labels with leader lines identify the 'Lower plate', 'Bubble level', and 'Adjustment feet: two on front and one on the middle back'.</p> <p>Adjustment and bubble level</p>

Table 1 Installation (continued)

Installation
(continued)

Plug In Instrument

Plug the power cord into the back of the unit and an outlet.

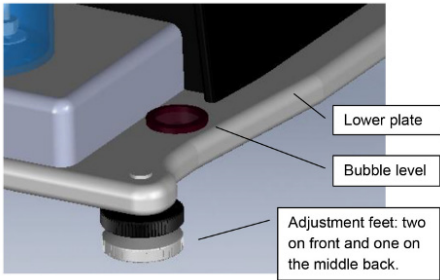
Only use the supplied power cord or one rated for VSA and certified for the country of use. The cord must be a minimum of 18 AWG and have a rating for 10 A or greater.

An incorrect main power voltage can damage the instrument.

Turn the Unit ON

Use the power switch on the back of the instrument to turn it on.

Allow the VSA a 2-h warm-up period to bring the scale into constant operating temperature and ensure accurate readings.

Leave the VSA powered on when not in use to maintain optimal instrument speed and performance. When not in use, the VSA will automatically enter standby mode.

Install Desiccant Tubes

Firmly seal the desiccant tube lid onto the desiccant tube.

Remove the black vinyl covers from the air fittings.

Lift the desiccant tube into the area above the desiccant receiver and then insert the fittings into the mating holes. Ensure the black fitting is placed into the corresponding black hole. The desiccant tube is sealed for flow purposes even if it may feel loose.

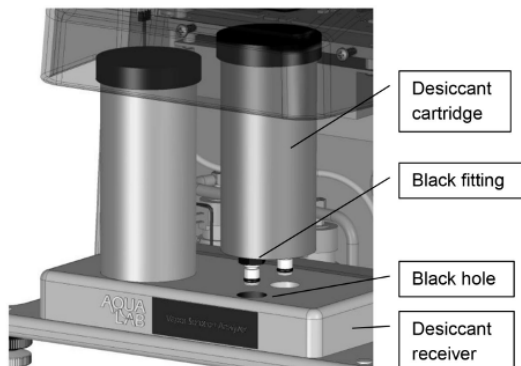

Desiccant installation

Install Air Cylinder and Weighing Pan

Verify the air cylinder and weighing pan are clean. Avoid dropping the parts to avoid damage that may affect performance.

Open the VSA lid.

Table 1 Installation (continued)

Insert the air cylinder into the sample block base. It should slide into the block easily and settle at the bottom of the bore.

Insert the weighing pan into the air cylinder.

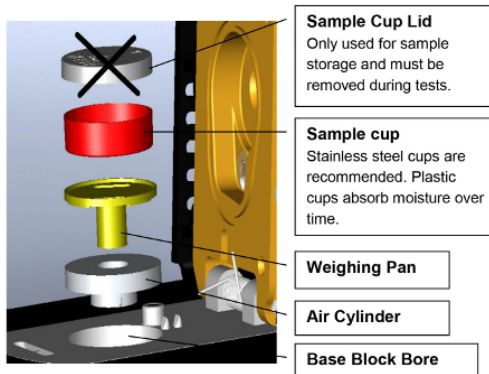

Sample cup and lower block assembly

NOTE: These parts should remain in the instrument continually and are only to be removed for maintenance.

Test Scale Stability

Select the Configuration tab.

Select Diagnostics.

Press **Enter**.

Scroll down, highlight Diagnostics, and press the **Enter** button.

Scroll down to the screen that shows the weight. Readings should vary no more than 0.5 mg, once the scale has stabilized.

Lightly tap the table with one finger.

If the readings vary more than 0.5 mg after tapping, the table holding the VSA is probably too unstable for accurate weight readings during a test. Shore up the table or find another location for the equipment.

NOTE: Contact the AQUALAB distributor if the scale readings are unstable after placing the unit on a stable structure.

Installation
(continued)

Table 1 Installation (continued)

Installation
(continued)

Fill the Water Tank

Remove the black plug on the clear plastic tank fill extension located on the back right of the VSA.

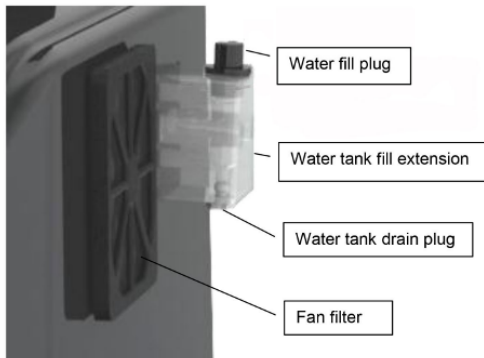

Tank fill extension

Fill the tank with steam distilled water until full to top.

Reinstall the black plug once finished. The black plug should be hand tightened only.

NOTE: Use the water tank drain plug to remove the water from the water tank. Place a receptacle below the plug to catch the water flow.

Connecting

Connect to Computer

Insert the USB drive from the Moisture Analysis Toolkit booklet into a Windows computer.

Open the Moisture Analysis Toolkit application and click through the installation wizard to download the software.

Remove the USB drive.

Plug in the USB cord into a Windows PC USB port and into the VSA COM port.

Open the Moisture Analysis Toolkit Software.

Select the METER USB COM port in the toolbar.

Click Connect.

5. CLEANING AND MAINTENANCE

Keeping the AQUALAB VSA clean is vital to maintaining the accuracy of the instrument. Dust and sampling debris can contaminate the sampling chamber, so regular cleaning is essential. Instructions for cleaning the VSA desiccant cartridge and the sample chamber are both in this section.

5.1 DESICCANT REPLACEMENT

During a test, if the VSA determines that a desiccant tube has exhausted its drying capacity, it automatically switches to the other desiccant tube. When this event occurs, a message appears indicating that the exhausted desiccant tube needs to be replaced.

1. Removal of the desiccant material.
 - a. Orient the desiccant cartridge or tube (Figure 24) so the lid or cap is up.

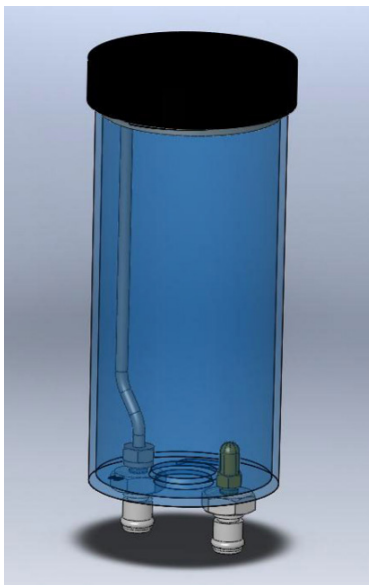

Figure 24 Desiccant cartridge

- b. Remove the main lid.
 - c. Remove the foam located below the lid as shown in Figure 25.



Figure 25 Desiccant cartridge foam

- d. Hold the small tubing at the top by curling the tubing over the top edge of the cartridge. This prevents desiccant from getting into it when emptying the cartridge.
- e. Pour out the desiccant material.
- f. Wash out the lid and washer. (Figure 26) Ensure no pieces of desiccant stick to the lid and shake off any excess water.



Figure 26 Desiccant lid

2. Loading the desiccant into the desiccant cartridge.
 - a. Orient the desiccant tube so the opening is upward.
 - b. Hold the tubing to the side of the cartridge and looped over the edge of the cartridge.
 - c. Fill the desiccant to the top of the cartridge.
 - d. Shake or vibrate the desiccant cartridge to settle the material.
 - e. The top of the desiccant should be about 0.1 inches from the cartridge rim. If not, add more desiccant and settle until it reaches 0.1 inches.

- f. Place in the foam at the top.
- g. Place the small tubing across the filter and through the slit in the foam (Figure 25).
- h. Wet the cartridge (bottle) lip and the edge of the washer adjacent to the bottle lip located in the lid with water as shown in Figure 26.
- i. Secure the lid to the desiccant cartridge.
- j. Verify the lid seal is correct by using the empty squeeze bottle.
 - i. Have a pan or cup with about one inch deep water in the bottom.
 - ii. Hold one finger over the output fitting.
 - iii. Pressurize the desiccant tube using the pressure bottle as shown in Figure 27.
NOTE: The bottle just needs to be squeezed with air in it, do not put water into the squeeze bottle.
 - iv. Place the desiccant tube with the lid into the water. If the lid is not sealed, the water could flow into the desiccant cartridge. Hold the tube in the water only as long as needed to verify the test.
 - v. Look for bubbles escaping from the lid. A large number of bubbles indicates the lid is not sealed. You must remove the lid and reset the washer. Lubricate the washer with water and put the lid back.



Figure 27 Checking desiccant for leaks

- k. When you place the desiccant cartridge into the desiccant receiver, wet the o-rings on the fittings for ease of installation and to reduce wear. Be sure to align the black fitting with the black ringed hole before insertion to ensure a proper seal.

AQUALAB VSA uses a 10 to 20 mesh indicating drierite as the desiccant. Indicating drierite is not required but the size of a replacement desiccant must be 10 to 20 mesh.

5.2 SAMPLE CHAMBER CLEANING

To clean the AQUALAB VSA, carefully follow these instructions and refer to the labeled diagram in [Figure 28](#). A video is also available at [AQUALAB 4TE certification \(metergroup.com/meter_knowledgebase/aqualab-4te-certification\)](https://www.metergroup.com/meter_knowledgebase/aqualab-4te-certification).

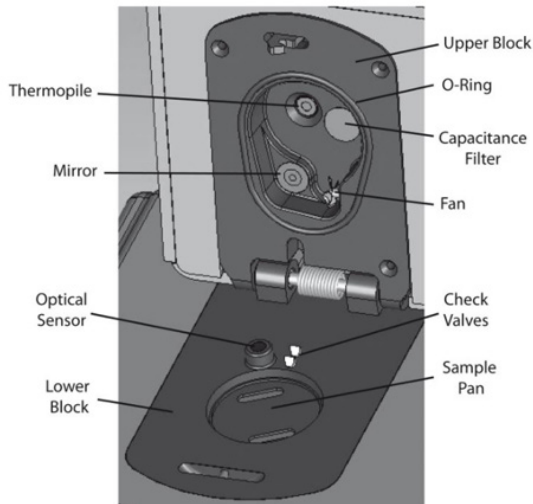

Figure 28 AQUALAB VSA sample chamber diagram

The purpose of the cleaning procedure is to remove grease, dirt, and other soluble substances that can absorb or release water during verification, calibration, or sample testing. The mirror must be clean for a smooth and even dew formation. Any contaminants (e.g., fingerprints) on the mirror can cause the dew to form unevenly and affect the accuracy of the reading.

The instrument should be cleaned if visual inspection indicates the chamber is dirty or as part of the verification process ([Section 5.2](#)). METER recommends cleaning before each new isotherm test.

5.2.1 CLEANING KIT

The AQUALAB comes with an AQUALAB Cleaning Kit that contains enough cleaning supplies to clean the instrument for about 1 year. The following supplies are included:

- Spatula (a thin plastic rod)
- Deionized water for cleaning
- Cleaning Solution

- KIMWIPES® tissues
- Activated charcoal

NOTE: Wash hands with soap and water, and wear clean gloves before starting the cleaning procedure. This prevents oils from contaminating the cleaning materials, the sample chamber, and the sensors.

5.2.2 CLEANING PROCEDURE

The procedure to clean AQUALAB VSA involves washing, rinsing, and drying each area. Do not get cleaning solution on the capacitance sensor filter. Repeated exposure of cleaning materials or contaminants to the filter may cause inaccurate readings and the filter will need to be replaced ([Section 5.3](#)).

NOTE: Isopropyl alcohol can be substituted for the Cleaning Solution.

1. Turn the AQUALAB VSA power OFF.
2. Open the chamber cover to expose the sample chamber and sensors.
3. Clean the sample chamber. The sample chamber consists of all surfaces inside the orange O-ring when the lid is closed.

NOTE: Be extremely careful not to damage the fan blades when cleaning the chamber.

- a. Remove any debris that may have collected within or around the sample chamber.
- b. Wrap a new tissue around the end of the spatula and moisten it with cleaning solution.
NOTE: Do not dip used tissue into the cleaning solution as the cleaning solution will become contaminated.
- c. Clean upper chamber, O-ring, and all surfaces of the sample block within the orange O-ring. Replace the tissue if it becomes too dirty during this process.
- d. Clean lower block with a fresh KIMWIPES tissue. Clean the entire block surface.
- e. Repeat [steps b](#) through [d](#) using a new KIMWIPES tissue moistened with deionized water.
- f. Repeat [steps b](#) through [d](#) using a new, dry KIMWIPES tissue to remove any moisture remaining from the cleaning.

NOTE: Do not reuse tissues.

4. Clean the mirror.
 - a. Wrap a new KIMWIPES tissue around the end of the spatula and moisten it with cleaning solution.
 - b. Gently swipe the moistened tissue across the mirror once. A single swipe is usually sufficient to remove contaminants.
 - c. Repeat [steps a](#) and [b](#) using a new KIMWIPES tissue moistened with deionized water.
 - d. Repeat [steps a](#) and [b](#) using a new, dry KIMWIPES tissue to remove any moisture remaining from the cleaning.
 - e. Visually inspect the mirror for cleanliness. Clean again if necessary.

CLEANING AND MAINTENANCE

5. Clean the thermopile and optical sensor.
 - a. Wrap a new KIMWIPES tissue around the end of the spatula and moisten it with cleaning solution.
 - b. Swipe the moistened tissue across the thermopile and optical sensor. A single swipe across the sensor is usually sufficient to remove contaminants.
 - c. Repeat [steps a](#) and [b](#) using a new KIMWIPES tissue moistened with deionized water.
 - d. Repeat [steps a](#) and [b](#) using a new, dry KIMWIPES tissue to remove any moisture remaining from the cleaning.
 - e. Visually inspect the thermopile and optical sensor for cleanliness. Clean again, if necessary.
6. Visually inspect the sample chamber and sensors for contaminants, including moisture. If necessary, repeat the cleaning process using new KIMWIPES tissues.
7. Let stand for 5 min to ensure the sample chamber is dry.
8. After cleaning the AQUALAB VSA, check the instrument performance and correct for any linear offset that may have occurred during the cleaning process.
 - a. Run a sample of the activated charcoal pellets from the AQUALAB Cleaning Kit. This cleans the air inside the chamber, helping it come back to a stable sampling environment.
 - b. Verify the linear offset against known verification standards as described in [Section 6.2](#).
 - c. If a linear offset has occurred, adjust for linear offset.

If the instrument is still not reading samples correctly, contact [Customer Support](#).

5.3 CAPACITANCE FILTER REPLACEMENT

The capacitance filter will need to be replaced if it becomes contaminated.

1. Open the sample chamber.
2. Use tweezers or a small knife blade to pry up the edge of the filter, being careful not to disturb the sensor beneath.
3. Discard the soiled filter.
4. Wash hands and put on gloves.
5. Press a new filter into place.

5.4 MAINTENANCE PACKAGES

METER offers maintenance and calibration packages to ensure AQUALAB is functioning to its highest standard ([Table 3](#)).

Table 3 Maintenance package options

Package	Basic Calibration Service
As-found inspection	Available
Replace old/damaged parts	Separate charge per part
Instrument cleaning	Included
Factory calibration	Included
Extended 1-year warranty	Not included
Loaner instrument	Available

Replacement parts can also be ordered from METER. Contact [Customer Support](#).

6. VERIFICATION AND CALIBRATION

It is important to verify the AQUALAB VSA water activity calibration against known standards to guarantee optimal performance and accuracy. METER recommends verification or once per shift or daily before use.

METER also recommends annual factory calibration to maintain optimal performance.

6.1 WATER ACTIVITY VERIFICATION

The AQUALAB VSA uses both a capacitance relative humidity sensor and a chilled-mirror dew point technique to determine water activity. If you set volatiles to yes, the VSA performs water activity verification on the capacitance sensor only. If you set volatiles to no, the VSA verifies the dew point sensor. While the instrument does not require a routine full calibration, it is important to verify for linear offset periodically. The components used by the instrument to measure water activity are subject to contamination which may affect VSA performance. When this occurs, it changes the accuracy of the instrument. This is what is called a linear offset.

Therefore, frequent verification assures the VSA is performing correctly. You can check linear offset by using two different verification standards.

6.1.1 VERIFICATION STANDARDS

Verification standards are specially prepared, unsaturated salt solutions having a specific molality and water activity value that are accurately measurable. The verification standards sent with the initial shipment are very accurate and available from METER. Using verification standards to verify accuracy can greatly reduce preparation errors. Verification standards come in seven water activity levels: 1.000, 0.984, 0.920, 0.760, 0.500, 0.250, and 0.150 (Table 4). The standards are produced under a strict quality assurance regime.

Table 4 Verification standards

Verification Standard at 25 °C	a_w
17.18 mol/kg LiCl	0.150 ±0.005
13.41 mol/kg LiCl	0.250 ±0.003
8.57 mol/kg LiCl	0.500 ±0.003
6.00 mol/kg NaCl	0.760 ±0.003
2.33 mol/kg NaCl	0.920 ±0.003
0.50 mol/kg KCl	0.984 ±0.003
Steam Distilled Water	1.000 ±0.003

NOTE: Safety Data Sheet (SDS) for these standards are available at [metergroup.com/food/meter-safety-data-sheets](https://www.metergroup.com/food/meter-safety-data-sheets).

Although distilled water and the 0.984 standard are available as a verification standard, METER does not recommend using them with the AQUALAB VSA.

To use a verification standard, remove the twist top and puncture the foil cap. Pour the contents into a sample cup.

NOTE: To avoid inaccurate water activity readings, verification standards should be used once immediately after opening. Do not store standards in sample cups for repeated use.

6.1.2 VERIFICATION OF CALIBRATION

Verification of the calibration should be performed regularly to ensure the AQUALAB VSA is operating within specification. Check the linear offset against two known verification standards before running a new isotherm test. Never verify the linear offset solely against a single standard, since it does not give an accurate representation of the linear offset. For best results, conduct the VSA water activity verification using the 0.25 a_w and 0.76 a_w standards.

NOTE: The verification process is the same whether you set the volatiles to yes or no, except that the accuracy for the capacitance sensor is $\pm 0.020 a_w$.

Checking the water activity of a standard solution checks for the possibility of unit contamination or shifts in the linear offset from other causes.

The following steps explain how to verify for linear offset of the AQUALAB VSA (Figure 29).

1. From the Isotherm Tab, navigate to the Measurement tab by pressing the **Enter** button.

NOTE: The AQUALAB VSA needs to warm up for approximately 15 min to make accurate readings.

2. Choose a 0.25 a_w standard.
3. Remove the weighing pan.
4. Empty a vial of solution into the stainless steel sample cup.
5. Place it in the AQUALAB VSA testing chamber. Make sure that the standard is as close to the instrument temperature as possible.

NOTE: Make sure the rim and outside of the sample cup are clean.

6. Carefully close the lid and move the lever to the READ position.
7. Take two readings.

The water activity readings should be within $\pm 0.005 a_w$ of the given value for the verification standard. The standards will read at 25 °C. If other temperatures are required, refer to Table 5.

Table 5 Temperature correction of verification standards

Temperature (°C)	Water	0.50 mol/kg KCL	2.33 mol/kg NaCl	6.00 mol/kg NaCl	8.57 mol/kg LiCl	13.41 mol/kg LiCl	17.18 mol/kg LiCl
15	1.000	0.984	0.923	0.761	0.492	0.238	0.140
20	1.000	0.984	0.922	0.760	0.496	0.245	0.145
25	1.000	0.984	0.920	0.760	0.500	0.250	0.150
30	1.000	0.984	0.920	0.760	0.504	0.255	0.155
35	1.000	0.984	0.920	0.760	0.508	0.261	0.160
40	1.000	0.984	0.921	0.760	0.512	0.266	0.165
50	1.000	0.984	0.894	0.740	0.517	0.275	0.172

NOTE: The AQUALAB VSA measures these verification standards to $\pm 0.005 a_w$, ± 0.02 with volatiles on yes. The readings may lead to one of three outcomes.

- If the AQUALAB VSA reads within $\pm 0.005 a_w$ of the first verification standard, take two readings of the 0.76 a_w standard. The second water activity reading for the second verification standard should be within $\pm 0.005 a_w$.
- If either verification standard is not correct, it is probably due to contamination of the sensor chamber. Clean and air out the chamber (Section 5) and repeat verification from step 2.
- If readings are consistently outside the water activity of the first verification standard by more than $\pm 0.005 a_w$, a linear offset can be applied. Adjust the reading to match the correct verification standard value (Section 6.2).

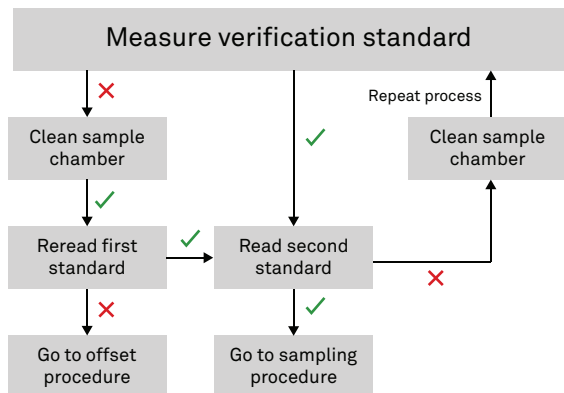

Figure 29 Verification standard flowchart. A check indicates AQUALAB VSA verified the standard within specification; a cross indicates AQUALAB VSA did not verify the standard within specifications.

6.2 LINEAR OFFSET

After verification and cleaning the instrument, an offset may be necessary.

NOTE: A linear offset does not adjust the calibration for all water activity levels and should only be used if measuring water activity in a very small range.

1. Navigate to the Configuration tab.
2. Select **Calibration**.
3. Select **Water Activity**.
4. Select **Start** (Figure 30).

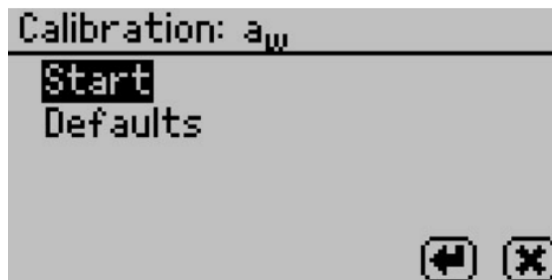

Figure 30 Start calibration

To return to the prior tab, select **CANCEL**.

5. A prompt will appear to insert a fresh standard and seal the chamber (Figure 31).

NOTE: The same verification standard can be used to verify and adjust the linear offset. If using the same verification standard, do not open the sample chamber between verification and offset.

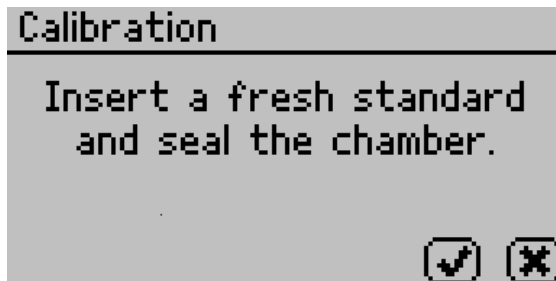

Figure 31 Calibration instruction dialog

6. Empty the whole vial of water activity standard into a sample cup.
METER recommends using the 6.00 NaCl (0.76 a_w). Do not adjust for the offset using steam distilled water.
7. Ensure the rim and outside of the cup are clean.
8. Place the sample cup in the sample chamber.
9. Carefully close the lid and move the lever to the READ position.

10. Select **OK** to begin testing.

NOTE: To interrupt the offset procedure, return the lever to the OPEN position or select **CANCEL** to return to the previous screen.

After the AQUALAB VSA has finished measuring the verification standard, it displays a Change the offset screen (Figure 32).

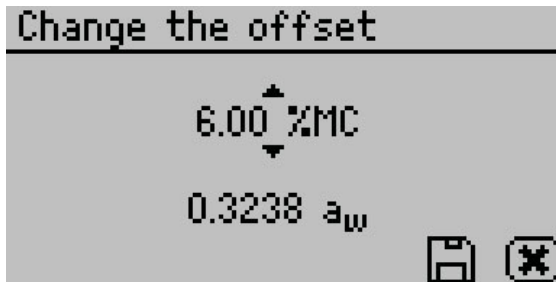

Figure 32 Change the offset screen

11. Use **UP** and **DOWN** to adjust the water activity reading to its proper value for the particular verification standard.
12. Select **SAVE** to store this new value.

To cancel and return to the main menu, select **CANCEL** to make no changes.

13. Restart the verification procedure in Section 6.1. If the instrument reads within $\pm 0.005 a_w$ with both standards, then the instrument is ready to begin testing.

If incorrect verification standard readings persist after cleaning the chamber and adjusting for linear offset, contact [Customer Support](#) for further instructions.

6.3 ADJUSTING FOR WEIGHT MEASUREMENT OFFSET

1. To adjust the balance, toggle to the Configuration tab by pressing the Menu icon. Calibration is the first option highlighted.

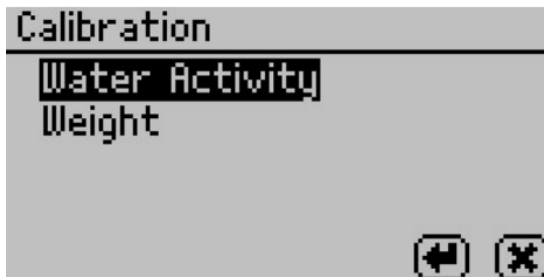

Figure 33 Calibration options

2. To adjust the balance, highlight weight, press the **Enter** button and the Calibration: Weight screen appears.

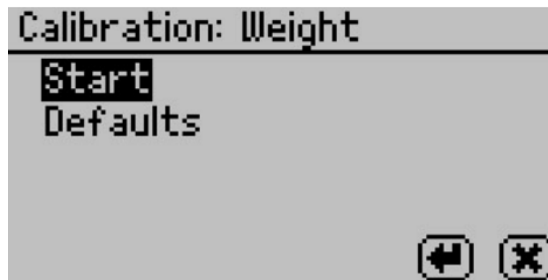

Figure 34 Calibration: Weight screen

3. Highlight start and press the **Enter** button. Follow the wizard on screen commands.
4. When asked to place the 2-g weight on the balance, handle carefully with tweezers and gloves to prevent changing the weight of the standard.
5. Carefully close the lid and move the lever to the read position. Press the **Enter** button to begin testing.
NOTE: If you decide at this point not to continue with the linear offset program, just return the lever to the Open position or press X to return to the previous screen.
6. After the VSA has finished measuring the weight verification, it displays the test value.
7. Press Save to adjust to the correct value. To cancel and return to the main menu, press the Cancel button and no changes be made.

If you continue to have problems with weight readings, contact [Customer Support](#).

6.4 RESTORE FACTORY DEFAULTS

To restore original calibration settings, do the following:

1. Navigate to the Configuration tab using **MENU**.
2. Select **Calibration**.
3. Select **Defaults** to access the Restore Factory Defaults routine.

Select **CANCEL** to return to the Configuration tab.

A confirmation dialog will appear ([Figure 35](#)). Similar screens appear if you are restoring the weight factory defaults, but the screen says weight instead of water activity.

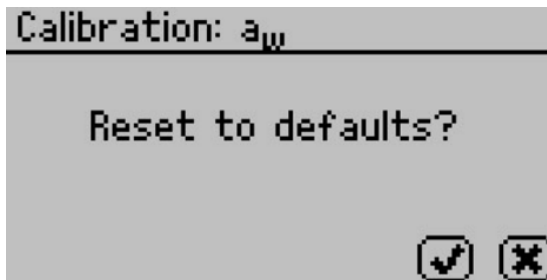

Figure 35 Confirmation dialog to reset defaults

4. Select **OK**.

Select **CANCEL** to return to the Calibration menu.

The instrument will confirm the factory calibration has been restored (Figure 36).

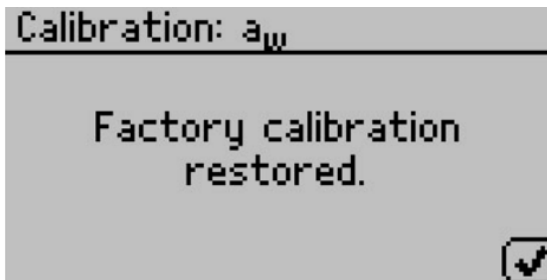

Figure 36 Confirmation that factory calibration was reset

5. Select **OK**.

6.5 ISOTHERM STANDARD COMPARISON

If concerns arise about the accuracy of the moisture sorption curve the VSA produces, it is possible to perform a moisture sorption standard comparison. This can only be done using the Moisture Analysis Toolkit software and must be performed on Microcrystalline Cellulose (MCC). METER included a sample of MCC with the instrument or you can use your own lab grade MCC. Contact [Customer Support](#) if you need additional MCC samples. To run an isotherm standard test, go to actions and select Run Standard Test in the software. This initiates a Test Wizard to walk you through the steps to initiate a test. The settings of this test are preset and the test takes four to five days to complete.

If the Moisture Analysis Toolkit software remains connected to the instrument throughout the duration of the standard test, the software prompts the user to save a .pdf report of the test, after which, it graphs the newly created isotherm for MCC along with a preloaded standard MCC curve to allow comparisons. To create a permanent copy of the newly created MCC curve, manually save it in the File Menu. This .pdf report contains a comparison of kinetic and moisture sorption isotherm curves, as well as an error value for the comparison of the newly created curve and the preloaded standard MCC curve. METER recommends a

sample size of 1 g when running the MCC standard test. An error value less than 0.12 would be acceptable. If the error value is greater or equal to 0.12, contact [Customer Support](#) for additional assistance.

If you disconnect the Moisture Analysis Toolkit software at any time while running the standard test, it does not automatically generate a comparison. Instead, save the completed MCC isotherm curve as a .vsa file and then manually compare it to the preloaded standard MCC curve. To do this, select Standard Comparison from the action menu in Moisture Analysis Toolkit software to open a file dialog box. Navigate to and open the .vsa file for the MCC isotherm curve. The software outputs this curve at the conclusion of the standard test and you can compare these curves with any previously saved MCC standard isotherm curves. Doing so initiates a comparison of this curve to the preloaded standard MCC curve and the system prompts you to save a .pdf of the comparison report. Customers can use the standard comparison feature anytime to make a comparison between previously saved MCC standard isotherm curves and the preloaded MCC standard curve.

7. RUNNING A TEST

7.1 BECOMING FAMILIAR WITH STAGES

The AQUALAB VSA uses test stages to maximize the utility of running an isotherm test. In the vocabulary of setting up and running moisture sorption isotherms with the VSA, an isotherm test is considered a collection of stages all performed on one sample. Consider each stage as a unique portion of a test with its own settings while conducting all stages on one sample and combining the results into one data set at the end of the isotherm test.

Because each stage is unique, an isotherm test could consist of one stage or up to twenty stages. An example of an isotherm test with multiple stages might be running a sample through full adsorption and desorption using the static DVS method for Stage One, then setting up Stage Two to run the same test, but using the DDI method on the same sample. Another example would be to run a sample through full adsorption and desorption at 15 °C for Stage One, then, in Stage Two, switch the temperature to 25 °C and run the same test on the same sample. This stage interface makes it easy to compare dynamic and static isotherms and utilize the advantages offered by both methods all on a single sample. It also makes it easy to edit currently running tests.

7.2 MOISTURE ANALYSIS TOOLKIT SOFTWARE

The Moisture Analysis Toolkit software is a powerful tool for interfacing with the AQUALAB VSA. The software makes it easy to download moisture sorption isotherm measurements from the VSA, view the data in table or chart form, export for use in other programs, and easily setup a new test with multiple stages.

The Moisture Analysis Toolkit software comes with the AQUALAB VSA and instructions for how to install and connect to the software are in [Section 4](#).

Extensive help files explain the various features and processes of the Moisture Analysis Toolkit. Click on the Help menu item and select the Moisture Analysis Toolkit Help submenu item to display the help files.

Contact [Customer Support](#) with any questions on how to get started with the software.

7.3 RUNNING A MOISTURE SORPTION ISOTHERM TEST

Before starting a test it is important to verify that the VSA is performing correctly using METER's Verification Standards. Please refer to [Section 6](#) for instructions on how to verify the VSA and adjust the calibrations if necessary. Tests can also be setup using a Wizard interface in the Moisture Analysis Toolkit software ([Section 7.2](#)).

NOTE: Before starting a test, refer to Appendix B to verify you are running under noncondensing conditions, as this could void your warranty.

1. Before starting a test, set the Volatiles: Yes/No option in the Configuration menu. If the sample has volatiles, select Yes otherwise select No.
2. On the Main screen, select the Test Wizard.

The Warning screen appears to let the user know that any data points currently on the instrument from previous tests disappear when a new test begins.

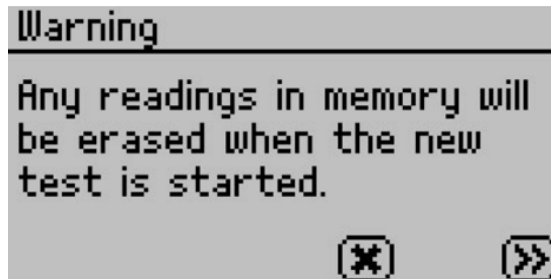

Figure 37 Warning screen before new test

3. Select the double right arrow to continue.
4. A new message reminding the user to make sure the water chamber is full and there is still active (blue) desiccant in the desiccant tubes.
[Section 4](#) has instructions on filling the water chamber and [Section 5.1](#) has instructions for replacing the desiccant.

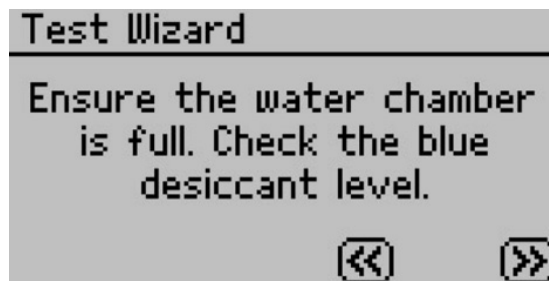

Figure 38 Message reminding user to check water and desiccant levels

5. Press the double right arrow to continue or the double left arrow to go back.
The Edit Test screen appears. The name of a previous test appears by default.



Figure 39 Edit test screen

6. To provide a name for the test, press the **Enter** button with Name highlighted and then use the arrow keys to create the name. When finished, press the Save button.
7. Enter initial moisture content if known (optional) by pressing the **Enter** button with Initial MC highlighted and use the up and down arrow to enter the correct moisture.



Figure 40 Initial moisture content screen

The %wb refers to the moisture reporting basis, which can be either wet basis (%wb) or dry basis (%db). The moisture content basis is set as a global preference in the Configuration tab (Section 2.4.3).

8. Press the double right arrow to continue or the double left arrow to go back.
9. Set up each stage of the isotherm test.

A stage is used to adjust the isotherm settings for an individual sample (up to 20 stages). Each stage is set up with the isotherm method (DDI or DVS) and the settings for that portion of the isotherm. A stage can be modified or deleted anytime before the test begins.

For example, for milk powder, Stage One could use the DDI method to ramp quickly from 0.1 to 0.4 a_w and Stage Two could use the DVS method to step from 0.4 to 0.8 a_w slowly in 0.05 a_w increments.

The stages for the prior test appear by default. You can use these stages as is or update them with new settings

If more than one stage is in memory, you have the option of inserting the stage after any existing stage in the test. If you need to delete or edit a stage, go to the specific stage, press the **Enter** button, and then select Edit or Delete.



Figure 41 Edit stages DDI method

10. Select New and press the **Enter** button.
A screen with several parameters will appear.

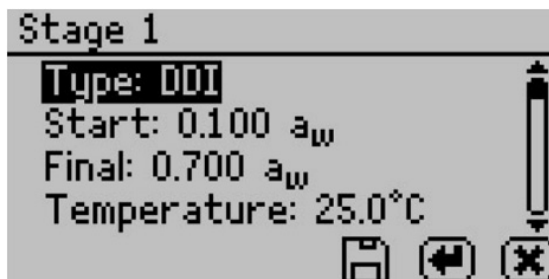

Figure 42 Edit stages DDI method

11. Select the isotherm method as either DDI or DVS.
DDI creates a dynamic isotherm and DVS makes a static or equilibrium isotherm. The other choices adjust according to your selected method.

For the DDI method

1. To choose the starting a_w , highlight "Start," press the **Enter** button, and then cycle to the desired value using the up and down arrows. You can choose any value between 0.03 and 0.95 a_w including current. Choosing current causes the stage to begin at the initial a_w of the sample. Press the Save button when finished.
2. To choose the final a_w , highlight "Final," press the **Enter** button, and then cycle to the desired value using the up and down arrows. You can choose any value between 0.03 and 0.95 a_w , including current. Selecting a final a_w that is lower than the starting a_w results in desorption, while selecting a final a_w higher than the starting a_w results in adsorption. Press the Save button when finished.
3. To choose the temperature of the stage, highlight "Temperature," press the **Enter** button, and then cycle to the desired temperature using the up and down arrow keys (hold down arrows for accelerated scrolling). You can choose any temperature between 15 and 60 °C and run each stage at a unique temperature.

- To choose the desired a_w resolution, highlight “Resolution,” press the **Enter** button, and then cycle to the desired value using the up and down arrows. Choose any value between 0.003 and 1.0 a_w . The resolution for DDI determines the target a_w resolution. Setting a higher step value makes the test faster, but decreases the a_w resolution. METER recommends a DDI step of 0.01 a_w .

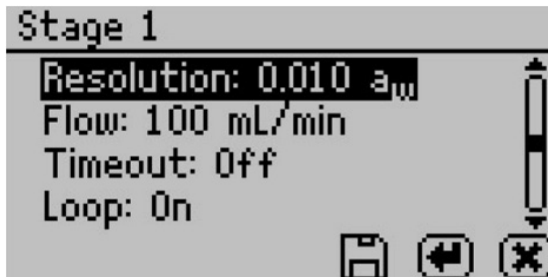

Figure 43 Edit stages DVS method

- To choose the air flow rate, highlight “Flow,” press the **Enter** button, and then cycle to the desired value using the up and down arrows. You can select any value between 10 and 163 ml/min. Higher flow rates speed up the test, but may result in lower data resolution and nonequilibrium conditions. The default value of 100 ml/min is suitable for most products.
- To choose to include a timeout setting, press the **Enter** button with “Timeout” highlighted, and then cycle to the desired value using the up and down arrows. You can select any value between 5.0 minutes and 30 days. The timeout determines the maximum time allotted to move from the starting a_w to the final a_w (DDI only) and is optional. The default value is off, which means there is no timeout value.
- To choose to have the isotherm loop, highlight “Loop” and press the **Enter** button to toggle between on and off. Turning loop on causes the isotherm to automatically return to the starting a_w (with the same settings) once the final a_w has been achieved. This would create both an adsorption and desorption curve (or vice versa depending on the starting direction).
- When finished adjusting the settings for the stage, press the Save button to save and return to the Edit Stage screen. Press Cancel to return to Edit Stage screen without saving changes.

For the DVS Method

1. To choose the starting a_w , highlight “Start,” press the **Enter** button.

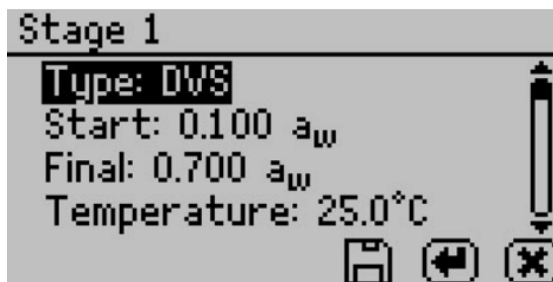

Figure 44 Edit stages DVS method

2. Cycle to the desired value using the up and down arrows.
Choose any value between 0.03 and 0.95 a_w including “current.” Choosing current means that the stage starts at the initial a_w of the sample.
3. Press the Save button when finished.
4. To choose the final a_w , highlight “Final,” press the **Enter** button.
5. Cycle to the desired value using the up and down arrows. Choose any value between 0.03 and 0.95 a_w including current (see current definition above). Selecting a final a_w that is lower than the starting a_w results in desorption, while selecting a final a_w higher than the starting a_w results in adsorption.
6. Press the Save button when finished.
7. To choose the temperature of the stage, highlight “Temperature,” press the **Enter** button with “Temperature” highlighted.
8. Cycle to the desired temperature using the up and down arrow keys. Choose any temperature between 15 and 60 °C and each stage can run at a unique temperature.
9. To choose the desired a_w step, highlight “Step,” press the **Enter** button.
10. Cycle to the desired value using the up and down arrows. Choose any value between 0.003 and 1.0 a_w . The step setting for DVS determines the a_w values for equilibration and consequently the resolution. A step setting of 0.10 a_w with a starting value of 0.1 a_w results in humidity being controlled to 0.1, 0.2, 0.3 ... up to the final a_w , remaining at each level until either equilibrium is achieved based on the trigger value or reaching the timeout value. Setting a higher value makes the test faster, but decreases the a_w resolution.

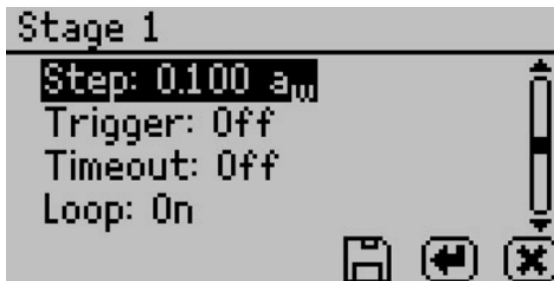

Figure 45 Selecting Stage 1 step interval

11. To choose the trigger %dm/dt value that indicates equilibration, highlight “Trigger,” press the **Enter** button to open a new window.
12. Cycle to the desired trigger value using the up and down arrows.

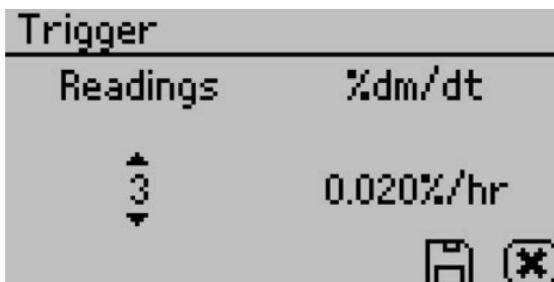

Figure 46 Selecting Trigger

The trigger can be shut off or be any value between 0.001 and 1%/hr. The trigger value represents an acceptable change in mass per change in time to indicate equilibrium for a given step.

Next, choose the number of readings or events meeting the trigger value that are required to achieve equilibration. For example, choosing 3 means that in order for a step to have reached equilibrium, three %dm/dt readings in row must be less than the set trigger value. You can choose any value between 1 to 10. Setting a higher trigger value and a lower number of events makes the test faster but may not result in complete equilibrium.

METER recommends beginning with two events at 0.01%/hr. If you turn the trigger off, the VSA holds the sample at each step for the time in the timeout setting. After adjusting all settings, press the Save button to save the settings and return to the Stage Setup screen.

13. To choose to include a timeout setting, highlight “Timeout,” press the **Enter** button.
14. Cycle to the desired value using the up and down arrows. Any value between 5.0 min to 30 days can be selected.

The timeout determines the maximum time allotted for each a_w step, not the time from starting a_w to final a_w . The default value is off, which means there is no timeout value and only the trigger value determines the end of step. If both a trigger value and timeout value are set, whichever is reached first determines the end of the step.

- To choose to have the isotherm loop, highlight “Loop” and press the **Enter** button to toggle between on and off.

Turning loop on causes the isotherm to automatically return to the start a_w (with the same settings) once the final a_w has been achieved. This would create both an adsorption and desorption curve (or vice versa depending on the starting direction).

- When finished adjusting the settings for the stage, press the Save button to save and return to the Edit Stage screen.

Press the Cancel button to return to Edit Stage screen without saving changes.

- After setting up all stages on the Edit Stage screen, select the double Right arrow.
- Follow the message on the screen to place an empty stainless steel cup in the chamber and seal it. Press the double right arrow to tare the cup.
- Follow the message on the screen to place the sample in the cup and select the double right arrow to weigh the sample.
- When filling the sample cup, remove the cup from the chamber to avoid spills in the chamber area.
- Press the **Enter** button to begin the test.

7.4 USING DDI TO INVESTIGATE GLASS TRANSITION

To investigate glass transition events using dynamic isotherms, run a DDI test with the initial water activity set to 0.1 a_w , final water activity > 0.80 a_w , flow rate of 80 to 100 ml/min, resolution of 0.01 a_w and no timeout should be used.

7.5 CREATING A WORKING ISOTHERM

Using the VSA Users can generate working isotherms using the VSA, as described in [Section 3](#), though it requires several steps.

- Isotherm Tests:** Generate two isotherm tests using the VSA, one for adsorption and one for desorption, with both starting at the “current” water activity value. A working isotherm is an analysis of the sorption characteristics of a sample starting from its native state. Generating this data requires the analysis of two sub-samples in the same condition as the original sample.
- Adsorption Curve:** Analyze one sub-sample for adsorption from its current state. Set up one stage of the test with your desired settings for method (DDI or DVS), temperature, step value, flow rate etc., but the starting water activity must be “current,” and the final water activity must be a value higher than the current water activity of the sample.
- Desorption Curve:** Analyze a second sub-sample for desorption from its current state. The test is again setup with one stage with desired settings for method (DDI or DVS), temperature, step value, flow rate etc., but the starting water activity must be “current,” and the final water activity must be a value lower than the current water activity of the sample.

7.6 EDITING A RUNNING ISOTHERM TEST

Users can edit a test that is already running by adding additional stages to a running test (inserted after the current running stage) at any time using the edit test function. This can be done using either the instrument interface or the software.

NOTE: To edit a test using the software, see the Moisture Analysis Toolkit software in [Section 7.2](#).

1. Press the Wizard icon as you did when starting a test. The Configure Test screen appears.

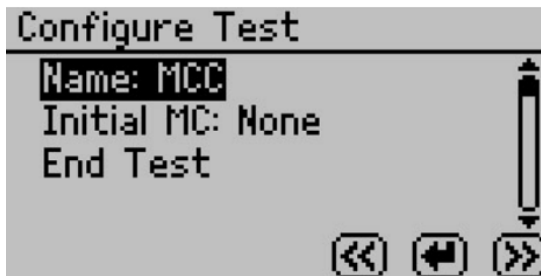

Figure 47 Configure Test screen

2. Press the double right arrow to edit the selected test. The Configure Stages screen appears.

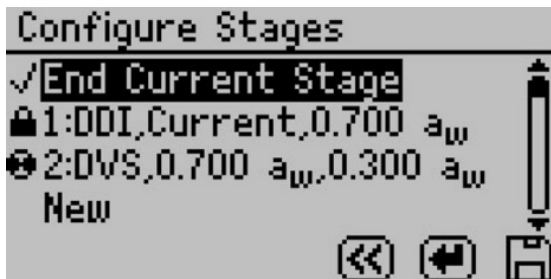

Figure 48 Configure Stages screen

The currently running stage (spinner icon) and any completed stages (lock icons) cannot be edited.

3. Add additional stages by selecting New and pressing the **Enter** button.
4. Set up each stage as outlined above.
5. To edit an existing stage that is not currently running and is not complete, select it and press the **Enter** button. Adjust the settings as instructed above.

NOTE: If you do not want to end the current stage, make sure there is not a check mark next to “End Current Stage.”
6. To alter a currently running stage, insert a new stage after the currently running stage. Make sure to set the starting a_w to “current” if you want the new stage to resume where the previous stage left off. Then select “End Current Stage,” press **Enter** to make a Check Mark appear and click the Save button. The current stage ends and the newly created stage begins.

7.7 RUNNING A WATER ACTIVITY TEST

Note: The Water activity test cannot be done when the isotherm test is running. You can also use the AQUALAB VSA as a water activity meter. For best results and temperature control, METER recommends using a clean stainless steel cup for water activity testing and that you remove the weighing pan and place the cup directly on air cylinder when testing for water activity. If you set volatiles to yes, the VSA determines water activity readings using the capacitance sensor, otherwise, it uses the dew point sensor.

1. From the Measurement tab, move latch left and reading starts automatically. The pinwheel spins when taking a measurement. Pressing the **Enter** button also starts a reading.
2. The a_w reading for the sample and the temperature displays when the VSA finishes.
3. Toggle the Volatiles Yes/No option in the Configuration menu to change between dew point and capacitive readings (Volatiles = Yes → Capacitive Sensor, Volatiles = No → dew point sensor).

8. SAMPLE PREPARATION

Proper sample preparation is important to keep the AQUALAB VSA clean and achieve repeatable results. A contaminated sample chamber can lead to unusually long read times and water activity readings that drift over time.

Carefully prepare and load samples to lengthen time between cleanings and help avoid downtime. Be consistent in sample preparation methods (e.g., crush, grind, slice the sample) to obtain reproducible results. For more information on proper sample preparation for different sample types, visit [Six AQUALAB sample preparation best practices \(metergroup.com/food/articles/six-sample-preparation-best-practices\)](http://SixAQUALAB.com/food/articles/six-sample-preparation-best-practices).

More specific considerations regarding sample composition are discussed in [Section 8.1](#) through [Section 8.4](#).

Follow the steps listed below to prepare samples:

1. Tare a stainless steel cup
2. Make sure the sample to be measured is homogeneous.
Multicomponent samples (e.g., muffins with raisins) or samples that have outside coatings (like deep-fried, breaded foods) can be measured, but they need to have representative portions in the cup and may take longer than other sample types to equilibrate.
3. Place the sample in a disposable sample cup.
 - a. Completely cover the bottom of the cup, if possible, to provide enough sample to get an accurate reading.

The AQUALAB VSA is able to accurately measure a sample that does not (or cannot) cover the bottom of the cup. For example, raisins only need to be placed in the cup and do not need to be flattened to cover the bottom.

A larger sample surface area increases instrument efficiency by providing more stable infrared sample temperatures. It also speeds up the reading by shortening the time needed to reach vapor equilibrium.

- b. METER recommends a sample size of 1,000 to 1,500 mg (the VSA can accommodate samples of 500 to 5,000 mg). This sample size gives a high resolution isotherm curve without adding excessive time to the test.
 - c. Do not fill the sample cup.

Overfilled cups can contaminate the chamber and do not make the readings faster or more accurate. Filling the sample cup can extend test time, create layering within the sample and case-hardening, and can lead to contamination of the chamber. The volume of sample versus weight of the sample has to be optimized for each material to achieve the desired resolution and test times.

4. Wipe any excess sample material from the rim and outside of the sample cup with a clean KIMWIPES tissue prior to loading the sample into the instrument.

Material left on the rim or the outside of the cup can contaminate the chamber and can be transferred to subsequent samples.

The nature of some samples results in longer reading times. These materials may need additional preparation to ensure accurate readings. Contact [Customer Support](#) for questions on sample composition.

Use the following steps to determine if further sample preparation is necessary:

1. Take several readings of the sample to see if the readings (a_w and time) stabilize.
2. If the readings take less than 6 min to stabilize, the sample can be handled normally. If the readings take longer than 6 min, remove the sample and take a reading of a verification standard ([Section 6](#)).
3. If the verification standard takes less than 6 min to test, the sample itself is causing the long read time. Refer to the following sections for pertinent sampling considerations. If the verification standard also takes longer than 6 min to test, the chamber may be dirty and will need to be cleaned ([Section 5](#)). Retest the sample after cleaning and verifying the instrument.

8.1 COATED AND DRIED SAMPLES

Samples with high sugar or fat coatings often require multiple readings because they equilibrate very slowly with the sample chamber.

Crush or slice the sample before sampling to reduce the time needed to take a water activity reading for coated or dried samples. This increases the surface area of the sample, thus decreasing reading times. However, modifying some samples may alter their water activity readings.

For example, a candy may have a soft chocolate center and a hard outer coating. The water activity reading for the center and the outer coating are different, so one would need to evaluate which part of the sample needed to be measured before crushing it. When the candy is crushed, the water activity represents the average water activity of the entire sample; leaving the candy whole gives a reading for the coating, which may act as a barrier to the center.

8.2 LOW WATER-EMITTING SAMPLES

Some extremely dry, dehydrated, highly viscous, water-in-oil emulsions (e.g., butter), high fat, or glassy compositions may require multiple readings because of their slow water-emitting properties.

METER recommends running the test as a DVS rather than DDI to ensure equilibrium is reached. DDI tests on these sample types do not reach full equilibrium and can show increased hysteresis. Sampling techniques are especially important for these sample types. The more surface area to volume the better the test runs. Glass beads can be helpful in some instances.

8.3 VOLATILE SAMPLES

Samples with certain volatiles in high enough concentrations may give inaccurate water activity values when using the chilled mirror. Volatiles condense on the mirror during the reading process but do not evaporate from the mirror as water does. As a result, the reading on samples with volatiles may not be accurate. The concentration of volatiles that causes interference is variable and matrix dependent.

To determine if volatiles are a problem, compare the dew point readings to capacitance readings. If the dew point readings are $>0.02 a_w$ higher than the capacitance readings, volatiles are likely a problem. The sample should be read with volatiles turned to on.

After measuring volatiles with the capacitance sensor, clean the chamber ([Section 5.2](#)), place charcoal in the chamber, and seal for a minimum of 5 min before switching to the dew point sensor.

8.4 LOW WATER ACTIVITY

When a sample water activity is below the cooling capacity of the chilled mirror, the VSA displays a less-than symbol or gives a low water activity message in the software. If the error persists, see [Section 9.1](#).

9. SERVICE

9.1 TROUBLESHOOTING

Table 6 lists common problems and their solutions. If the problem is not listed or these solutions do not solve the issue, contact [Customer Support](#).

NOTE: Read through the troubleshooting portions thoroughly before contacting **METER** for assistance. If the **AQUALAB VSA** instrument was purchased from an international distributors, please contact them for local service and support.

Table 6 Troubleshooting the AQUALAB VSA

Problem	Possible Solutions
<p>VSA does not turn on</p>	<p>Ensure the power cord is securely attached to the back of the instrument and plugged into the power outlet.</p> <p>A power surge may have caused a fuse to blow. To change the fuses:</p> <ul style="list-style-type: none"> • Unplug the power cord. • Locate the panel where the power cord plugs in. The fuse box is on the right side of that panel. Press the release tab and pull the fuse-holder out. • Pull the broken fuse out and replace with a 2-A, 250-V fuse. <p>CAUTION: Do not use any other kind of fuse to avoid damaging the instrument or voiding the warranty.</p> <ul style="list-style-type: none"> • Replace the fuse holder and push it into the fuse well until the release tab snaps in place. • Connect the power cord and turn the instrument on. <p>If the fuse blows again, a failed component may be causing the problem. Contact Customer Support to make arrangements for repairs.</p>
<p>Readings are slow or inconsistent</p>	<p>The sample chamber may be dirty. Refer to Section 5 for directions on cleaning the sample chamber.</p> <p>Some products absorb or desorb moisture very slowly, causing measurements to take longer than usual, and nothing can be done to speed up the process. Refer to Section 8.</p> <p>The sample may contain volatiles. Volatiles cause unstable readings because they condense on the surface of the chilled mirror. Please refer to Section 8.3</p> <p>A fan blade in the block chamber may be broken or bent. If even salt standards take a long time to read, and the sample chamber is clean, inspect the fan blade. If the fan appears damaged contact Customer Support.</p>
<p>Water activity readings on verification standards are too high or too low and a linear offset adjustment cannot be made any higher or lower</p>	<p>The thermopile, which measures sample temperature, may have become contaminated. Refer to Section 5 for directions on cleaning.</p> <p>The chamber mirror may be dirty. Refer to Section 5 for directions on cleaning.</p>

Table 6 Troubleshooting the AQUALAB VSA (continued)

Problem	Possible Solutions
Remove sample. Sample is too hot! error message	The sample temperature is too high for the instrument to equilibrate within a reasonable amount of time. Ensure samples are at the same temperature as the instrument.
Displayed α_n is below instrument detection limits	<p>The sample is too dry for the instrument to read accurately. If a sample has a water activity that is less than the detection limits of the instrument, this message appears. There is not enough sample moisture to condense on the mirror and provide a reading.</p> <p>The mirror may be dirty. Clean the mirror and chamber (Section 5.2) and measure the sample again.</p>
Dew point sensor failure error message	The cooler is damaged and needs to be serviced by METER. Refer to Section 9.3 for detailed instructions.
Verification is not correct	<p>Clean the sample chamber and components. Refer to Section 5 for detailed cleaning instructions.</p> <p>If verification is still not correct, verify and adjust for linear offset (Section 6.2).</p>
Crystal Failure. See Manual for options. error message	The crystal that runs the firmware is having trouble starting. Cycle the power. If this message continues to appear, the instrument needs to be serviced by METER (Section 9.3).
Contaminated mirror. error message	Clean the chamber mirror (Section 5.2) and run the sample again. If this message continues to appear, contact Customer Support .
Firmware is corrupted. See Manual for options. error message	The firmware on the instrument is corrupted and needs to be reloaded. To download new firmware to the AQUALAB VSA models, the instrument must be serviced by METER (Section 9.3).
Missing bootstrap loader error	The instrument cannot download new firmware updates. The instrument needs to be serviced by METER (Section 9.3).
Annual calibration reminder	<p>This message appears at least 1 year since the instrument has been calibrated and serviced by METER or local distributor. Return the instrument to ensure that the VSA is working effectively (Section 9.3).</p> <p>Click remind me later to be reminded in a couple of weeks, click do not display again if you do not want the device to remind you in the near future.</p>
No equilibration points available! error message	<p>There are no data points in which the weight has stabilized. The time it takes for an equilibration point to appear depends on the sample phase changes and stage trigger timeout specifications.</p> <p>Press the up or down arrow to view detailed data other than equilibration points.</p>
Desiccant cartridge is low	Replace the desiccant cartridge desiccant (Section 5.1).

Table 6 Troubleshooting the AQUALAB VSA (continued)

Problem	Possible Solutions
Low or High System Pressure Warning	<p>Ensure the gas input plug is properly installed.</p> <p>Turn the external gas setting on or off (as applicable).</p> <p>Check that external gas pressure is within the recommended range for running a test.</p> <p>Reinstall the desiccant tubes properly (Section 4).</p> <p>Check that the water chamber plug is properly installed (Section 4).</p> <p>Check that the pump system is operating normally.</p> <p>If you continue to receive a message after the above items have been checked, contact Customer Support for further options.</p>
Power was reset message	<p>Power was lost during a test.</p> <p>If Auto Restart is on, the test automatically resumes after a device reset. If Auto Restart is turned off, then the test stops running following a device reset. To prevent device resets, METER strongly recommends connecting the VSA to an Uninterruptible Power Supply (UPS).</p>
Scale failure	<p>The VSA cannot communicate with the scale.</p> <p>If the scale is reading overload or underload, then the balance is either misaligned or broken. If any of these instances occur, the instrument needs to be serviced by METER (Section 9.3).</p>
Scale Reading Instability message	<p>The VSA is unable to read stable readings from the balance.</p> <p>Clean the sample chamber, air cylinder, weighing pan, and the space under the air cylinder.</p> <p>Check the air cylinder for damage.</p> <p>If this message continues to appear, contact Customer Support.</p>
Critical error while starting the test	<p>Verify the sample weighed at least 5 mg.</p> <p>Verify the test has a name.</p> <p>Verify the test has at least one stage.</p> <p>If this message continues to appear, contact Customer Support.</p>
Cannot communicate with the VSA	<p>Plug in the VSA USB cable in to power and the instrument.</p> <p>Verify the correct COM port is selected.</p> <p>Restart the VSA.</p> <p>Restart the computer software.</p>

Table 6 Troubleshooting the AQUALAB VSA (continued)

Problem	Possible Solutions
Weight is decreasing during absorption	<p>Fill the water tank (Section 4).</p> <p>Secure the water chamber plug.</p> <p>Verify the pump is working.</p> <p>Check if sample material is undergoing a phase change.</p> <p>Calibrate the scale.</p>
Weight is increasing during desorption	<p>The desiccant may be used up. Refill the desiccant (Section 5.1).</p> <p>Check the desiccant cartridge for leaks.</p> <p>Verify the pump is working.</p> <p>Calibrate the scale.</p>
Isotherm test has stopped prematurely	<p>Download the test with the Moisture Analysis Toolkit.</p> <p>Navigate to the Table view.</p> <p>Scroll to the last data record on the list.</p> <p>Look in the Special Condition column to see what caused the test to stop prematurely.</p> <p>Refer to the troubleshooting section for the special condition indicated.</p>
Isotherm test is taking an unusually long time to complete, even at high flow rates	<p>Sample has very slow sorption properties.</p> <p>Increase the flow rate.</p> <p>Fill the water tank (Section 4).</p> <p>The desiccant may be used up. Refill the desiccant (Section 5.1).</p>
Scale readings are not stable or the sample cups cannot be tared	<p>Secure the bench or support for the VSA.</p> <p>Clean the air cylinder.</p> <p>Verify actuation using ACT Button on the Diagnostics screen (Section 2.4.3.18).</p> <p>Interior parts have shifted and are contacting so air cylinder does not slide. Contact Customer Support.</p>
Scale calibration is failing	<p>Air cylinder and internal parts need to be cleaned.</p> <p>Air cylinder is not actuating and may be sticking due to contamination in the chamber.</p>
Desiccant cartridges are hard to install	<p>Dampen the o-rings on the desiccant cartridge with water.</p>
Poor temperature control	<p>Clean the filters on the external enclosure fans.</p> <p>Check that the external enclosure fan is operational.</p>

Table 6 Troubleshooting the AQUALAB VSA (continued)

Problem	Possible Solutions
Balance Communication Failure error message	Press the check button to retry balance communication. Cycle the power on the instrument. Contact Customer Support .
Sensors are reading outside of the typical range	If, after cleaning the instrument and following troubleshooting guidelines, there is still a measurement error, navigate to the Diagnostics screen. If the sensor is reading outside of this range, contact Customer Support .

If, after cleaning the instrument and following the other troubleshooting hints, consult the Diagnostics screen that displays values for component performance. Navigate to the Configuration tab and then scroll down to the Diagnostics option. Press **Enter** to open a list of components and their values.

This screen shows typical values for the temperature sensors on the instrument. Press up and down to scroll between the different pages. Lid, base, and sample temperatures may fluctuate but should not change more than 0.03 °C. Typical ranges for the lid, base and sample temperatures are between 24.5 and 25.5 °C, when unit temperature is set to 25 °C.

If the mirror temperature is at lid temperature, the cooler has failed and must be replaced. If the mirror is below the lid temperature or appears to be random, the thermocouple wire is broken and must be repaired. If the lid temperature is much higher than the set temperature, the lid fan may have failed and must be replaced.

- **RH:** The capacitive sensor RH percentage, which should always be between 0 and 100%.
- **Weight:** The weight measurement updates in real-time and can be zeroed for measurements by pressing the scale icon (second button from the left). If the weight reads overload or underload, the balance is broken and needs to be replaced. A negative value indicates that the balance needs to be re-zeroed if you want to take weight measurements.
- **Optical:** A typical optical range is between 500 mV and 2900 mV.
- **Latch:** Open and close the latch while monitoring the latch status on the screen. If the screen does not update the latch status, the latch magnet may need to be reseated (with the correct polarity) or the Hall Effect sensor needs to be realigned with the magnet.
- **Actuator:** The Act button toggles the actuator on and off, lifting the sample pan up and down to confirm the actuator functions properly. Use this button to verify that the actuator works correctly and that it is not throwing off weight readings. Occasionally contaminants or defects can cause the cylinder to stick and prevent accurate weight measurements.
- **Pump:** The pump pressure is only valid when the pump is active. When the pump is off, the pressure should be between 0 and 0.7 kPa. This pressure reading also applies to an auxiliary air supply. When the air supply is active the pressure in the system should not exceed 52 kPa. If the pump pressure continually reads zero (even when you press the switch desiccant button) then the pump system may need to be serviced.

- **Desiccant:** The desiccant humidity value indicates the effectiveness of the desiccant tubes. Initially when the diagnostic screen is turned on, the pump supplies flow through the active desiccant tube to help verify that it can desiccate properly. After 30 seconds of pumping, the desiccant humidity reading should be 5% or less. If the desiccant humidity is unable to reach 5% humidity, refer to [Section 5.1](#) for instructions on replacing the desiccant tubes.
- **Weight Cal:** The weight calibration saved a scalar into memory that applies to all subsequent weight readings. A scalar of 1 means that the weight has not been changed from the default factory calibration. If the scalar strays too far from 1, you may need to reverify the balance and also certify the weight standard again.
- **Dew Offset:** The chilled mirror dew point calibration offset is zero if it is running off of the default factory calibration. This value indicates the offset the instrument applies to the water activity readings for accurate readings.
- **Cap Offset:** The capacitive RH calibration offset is zero if the VSA is running off of the default factory calibration. This value indicates the offset the instrument applies to the water activity readings for accurate readings.

9.2 CUSTOMER SUPPORT

NORTH AMERICA

Customer service representatives are available for questions, problems, or feedback Monday through Friday, 7:00 am to 5:00 pm Pacific time.

Email: support.food@metergroup.com
sales.food@metergroup.com

Phone: +1.509.332.5601

Fax: +1.509.332.5158

Website: metergroup.com

EUROPE

Customer service representatives are available for questions, problems, or feedback Monday through Friday, 8:00 to 17:00 Central European time.

Email: support.europe@metergroup.com
sales.europe@metergroup.com

Phone: +49 89 12 66 52 36

Fax: +49 89 12 66 52 20

Website: metergroup.de

If contacting METER by email, please include the following information:

Name	Email address
Address	Instrument serial number
Phone	Description of the problem

NOTE: For products purchased through a distributor, please contact the distributor directly for assistance.

9.3 REPAIR

METER repairs manufacturer defects and instruments within the 1-year warranty at no charge. Repairs outside of the warranty window are charged based on cost of parts, labor, and shipping. An extra fee may be charged for rush work. Contact [Customer Support](#) for an estimated repair cost.

METER has loaner instruments available for a fee while the AQUALAB VSA is being serviced.

All AQUALAB VSA units returning to METER for servicing must be accompanied with a Return Merchandise Authorization (RMA) number. Prior to shipping the instrument, contact [Customer Support](#) to obtain an RMA number.

1. Place the AQUALAB in a plastic bag to avoid disfiguring marks from the packaging.
2. Do not ship the power cord, serial cable, or any other accessories.
3. Ship the AQUALAB in its original cardboard box with suspension packaging.
If the original packaging is not available, use a box with at least 4 in of packing material (e.g., Styrofoam™ peanuts or bubble wrap) between the instrument and each wall of the box, ensuring the instrument is suspended in the packing material.
4. On the RMA form, please verify the ship to and bill to information, contact name, and problem description. If anything is incorrect, please contact [Customer Support](#).
5. Tape the box in both directions for added support.
6. Include the RMA number in the attention line on the shipping label.

A Certificate of Calibration will be issued upon completion of the work.

9.4 TERMS AND CONDITIONS

By using METER instruments and documentation, you agree to abide by the METER Group, Inc. USA Terms and Conditions. Please refer to metergroup.com/terms-conditions for details.

APPENDIX A. NONCONDENSING CONDITIONS FOR VSA TESTING

This table shows the maximum advisable ambient humidity levels for the ambient room and test temperatures. Staying within these limits prevents condensation in and on the VSA. Operating in humidity and temperature conditions beyond these limits voids the VSA warranty and can damage the instrument. Please contact us if you have any questions or require any additional assistance.

Non-Condensing Ambient Humidity Limit for Test Temperatures Below 25°C					
Ambient Temperature (°C)	15°C Test	17°C Test	20°C Test	23°C Test	25°C Test
16.0	93.8	100.0	100.0	100.0	100.0
17.0	88.0	100.0	100.0	100.0	100.0
18.0	82.6	93.9	100.0	100.0	100.0
19.0	77.6	88.2	100.0	100.0	100.0
20.0	72.9	82.9	100.0	100.0	100.0
21.0	68.6	77.9	94.0	100.0	100.0
22.0	64.5	73.3	88.4	100.0	100.0
23.0	60.7	69.0	83.2	100.0	100.0
24.0	57.1	64.9	78.4	94.1	100.0
25.0	53.8	61.2	73.8	88.7	100.0
26.0	50.7	57.6	69.5	83.6	94.2
27.0	47.8	54.3	65.6	78.8	88.8
28.0	45.1	51.2	61.8	74.3	83.8
29.0	42.6	48.4	58.3	70.1	79.1
30.0	40.2	45.6	55.1	66.2	74.6
31.0	37.9	43.1	52.0	62.5	70.5
32.0	35.8	40.7	49.1	59.1	66.6
33.0	33.9	38.5	46.4	55.8	62.9
34.0	32.0	36.4	43.9	52.8	59.5
35.0	30.3	34.4	41.5	49.9	56.3
36.0	28.7	32.6	39.3	47.2	53.3
37.0	27.1	30.8	37.2	44.7	50.4
38.0	25.7	29.2	35.2	42.4	47.8
39.0	24.4	27.7	33.4	40.1	45.3
40.0	23.1	26.2	31.7	38.0	42.9

INDEX

A

accuracy 4
annual calibration service 37, 38

B

beep 6

C

calibration 38
 restore 43–44
Certificate of Calibration 1, 65
charcoal 36
cleaning 31–34
 cleaning kit 1, 34–35
 procedure 35–36
compliance 5
components
 buttons 6
 display screen 5–15
 power cord 1
 USB cable 1
contamination 39
customer support 64

E

email address 64

F

fax number 64
fuse 59

L

linear offset 38, 41–42
loaner instrument 65

M

maintenance 37

P

phone number 64

R

read time 4, 56, 57
repair 65–66
RMA number 65

S

sample composition
 coated 57
 dried 57
 multicomponent 56
sample cup 4, 56–57
sample preparation 56
specifications 4–5
 compliance 5
 measurement 4
 physical 4–5
 power voltage 5

T

temperature 4, 5
terms and conditions 65–66
troubleshooting 59–61

V

verification 31–35
verification standards 1, 38–39, 40

W

water activity 4

METER Group, Inc. USA

2365 NE Hopkins Court Pullman, WA 99163
T: +1.509.332.2756 F: +1.509.332.5158
E: info@metergroup.com W: metergroup.com

METER Group AG

Mettlacher Straße 8, 81379 München
T: +49 89 1266520 F: +49 89 12665220
E: info.europe@metergroup.com W: metergroup.de

