



METER

AQUALAB® TDL

TABLE OF CONTENTS

1. Introduction	1
2. Operation	2
2.1 Installation	2
2.2 Sample Preparation	3
2.2.1 Sample Composition	4
2.2.2 Sample Temperature	5
2.3 Taking a Reading	6
2.4 Viewing Data	8
2.5 Setting Up Isotherm-Determined Moisture Content	9
2.6 Performing a Linear Offset	16
3. System	19
3.1 Specifications	19
3.2 Components	20
3.2.1 Cords and Cables	21
3.2.2 Sample Chamber	21
3.2.3 Buttons	22
3.2.4 Display Screen	23
3.3 Theory	34
3.3.1 Water Activity	34
3.3.2 Water Potential	37
3.3.3 Moisture Content	38
3.3.4 Sorption Isotherms	38

4. Service	39
4.1 Verification and Calibration	39
4.1.1 Water Activity Verification	39
4.1.2 Linear Offset	41
4.1.3 Multipoint Calibration.....	43
4.1.4 Restore Factory Defaults	46
4.2 Cleaning.....	48
4.2.1 Cleaning Kit	48
4.2.2 Cleaning Procedure.....	49
4.3 Maintenance Packages	50
4.4 Repair	50
4.5 Troubleshooting	51
4.6 Customer Support.....	53
4.7 Terms and Conditions	54
Reference	55
Index	56

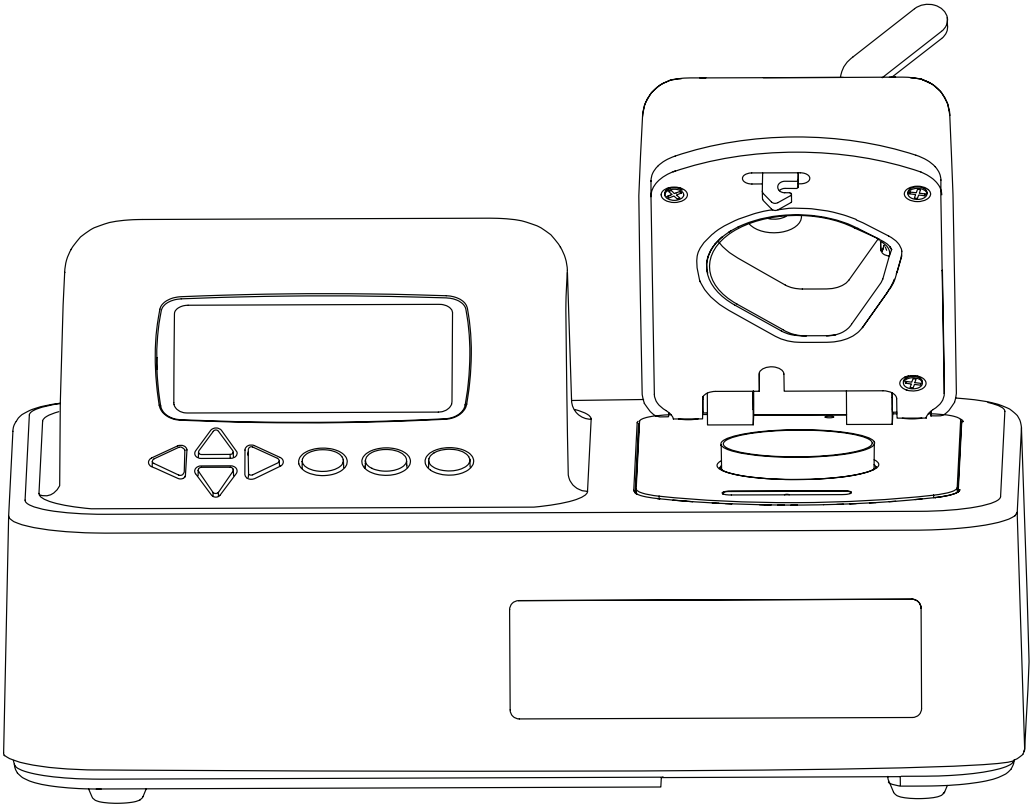

1. INTRODUCTION

Thank you for choosing the AQUALAB® TDL Water Activity Meter from METER Group, Inc. USA. AQUALAB is the most accurate and most reliable instrument available for measuring water activity (a_w).

This manual includes instructions for the AQUALAB TDL and AQUALAB TDL 2. For simplicity, both will be referred to as "AQUALAB TDL" and all instructions in this manual apply to both instruments: setting up the instrument, verifying its calibration, preparing samples, and taking readings as well as instructions on proper care, maintenance, and cleaning. Contact [Customer Support](#) with any questions about your TDL.

Verify all of the listed instrument contents shipped and appear in good condition:

- AQUALAB TDL Water Activity Meter
- Calibration certificate
- Power cord
- USB A to B cable
- 250 disposable sample cups
- AQUALAB Cleaning Kit
- Two vials each of the following verification standards solutions:
 - 1.00 a_w Pure Steam Distilled H₂O
 - 0.984 a_w 0.50 mol/kg KCl
 - 0.920 a_w 2.33 mol/kg NaCl
 - 0.760 a_w 6.00 mol/kg NaCl
 - 0.500 a_w 8.57 mol/kg LiCl
 - 0.250 a_w 13.41 mol/kg LiCl

2. OPERATION

Please read all instructions before operating the AQUALAB TDL to ensure the instrument performs to its full potential. Please contact [Customer Support](#) at any time for assistance with installation and setup.

Please observe the following considerations carefully.

- Only allow personnel qualified by METER to carry out service work on the electrical components.

A Certificate of Calibration will be issued upon completion of the work.

- Never remove the housing of the instrument. There are no parts inside the housing that can be serviced or replaced by the user.

WARNING: There is a risk of damaging the instrument or of causing serious injury if the live components are touched.

- Only operate this instrument with a main power voltage specified for it (100 to 240 V AC at 50–60 Hz).
- An incorrect main power voltage can damage the instrument.
- Plug the instrument into a grounded outlet or power strip.
- Only use the fuse type and rating specified for this instrument ([Section 3.1](#)).

If the instrument is used in a manner not specified by the manufacturer, the protection provided by the equipment may be impaired.

CAUTION

METER sensors are built to the highest standards, but misuse, improper protection, or improper installation may damage the sensor and possibly void the manufacturer's warranty. Before integrating AQUALAB TDL into a system, make sure to follow the recommended installation instructions and have the proper protections in place to safeguard sensors from damage.

2.1 INSTALLATION

Follow the steps listed in [Table 1](#) to set up the AQUALAB TDL.

Table 1 Installation

Preparation	<p>Select Clean, Level Location</p>
	<p>Preserve cleanliness to prevent contamination of the sample chamber.</p> <p>Maintain a level surface to reduce the chance of spilling sample material and contaminating the sample chamber.</p> <p>Select a location where the temperature remains fairly stable to avoid temperature changes that can affect accuracy (away from air conditioner and heater vents, open windows, etc.)</p> <p>NOTE: Always ensure the sample chamber is empty prior to moving the instrument.</p>

Table 1 Installation (continued)

Installation	<p>Plug In Instrument Plug the power cord into the back of the unit and an outlet.</p> <p>Only use the supplied power cord or one rated for AQUALAB TDL and certified for the country of use. The cord must be a minimum of 18 AWG and have a rating for 10 A or greater.</p> <p> WARNING An incorrect main power voltage can damage the instrument.</p> <p>Turn the Unit ON Use the power switch on the back of the instrument to turn it on (Section 3.2).</p> <p>Allow the AQUALAB TDL a 15-min warm-up period to ensure the most accurate readings.</p> <p>Select the User Profile (Optional) If user profiles are set up, the User screen appears first (Section 3.2.4).</p> <p>Use UP and DOWN to select the appropriate user profile.</p>
---------------------	---

2.2 SAMPLE PREPARATION

Proper sample preparation is important to keep the AQUALAB TDL clean and achieve repeatable results. A contaminated sample chamber can lead to unusually long read times and water activity readings that drift over time.

Carefully prepare and load samples to lengthen time between cleanings and help avoid downtime. Be consistent in sample preparation methods (e.g., crush, grind, slice the sample) to obtain reproducible results. For more information on proper sample preparation for different sample types, visit [Insider Sample Prep Strategies for Faster, More Accurate Readings](http://metergroup.com/en/meter-food/webinars/insider-sample-prep-strategies-faster-more-accurate-readings) (metergroup.com/en/meter-food/webinars/insider-sample-prep-strategies-faster-more-accurate-readings).

More specific considerations regarding sample composition and sample temperature are discussed in [Section 2.2.1](#) and [Section 2.2.2](#), respectively.

Follow the steps listed below to prepare samples:

1. Make sure the sample to be measured is homogeneous.

OPERATION

Multicomponent samples (e.g., muffins with raisins) or samples that have outside coatings (like deep-fried, breaded foods) can be measured, but they need to have representative portions in the cup and may take longer than other sample types to equilibrate.

2. Place the sample in a disposable sample cup.
 - a. Completely cover the bottom of the cup, if possible, to provide enough sample to get an accurate reading.

The AQUALAB TDL is able to accurately measure a sample that does not (or cannot) cover the bottom of the cup. For example, raisins only need to be placed in the cup and do not need to be flattened to cover the bottom.

A larger sample surface area increases instrument efficiency by providing more stable infrared sample temperatures. It also speeds up the reading by shortening the time needed to reach vapor equilibrium.

- b. Do not fill the sample cup more than half full.

Overfilled cups can contaminate the chamber and do not make the readings faster or more accurate.

3. Wipe any excess sample material from the rim and outside of the sample cup with a clean KIMWIPES® tissue prior to loading the sample into the instrument.

Material left on the rim or the outside of the cup can contaminate the chamber and can be transferred to subsequent samples.

4. If a sample cannot be measured immediately, put the disposable sample cup lid on the cup to restrict water transfer.

If waiting more than 20 min to measure the sample, seal the cup with Parafilm® wax or a similar material. Properly sealed samples can be measured up to 4 h after sampling.

2.2.1 SAMPLE COMPOSITION

The nature of some samples results in longer reading times. These materials may need additional preparation to ensure accurate readings. Contact [Customer Support](#) for questions on sample composition.

Use the following steps to determine if further sample preparation is necessary:

1. Take several readings of the sample to see if the readings (a_w and time) stabilize ([Section 2.3](#)).
2. If the readings take less than 6 min to stabilize, the sample can be handled normally. If the readings take longer than 6 min, remove the sample and take a reading of a verification standard ([Section 4.1.1](#)).
3. If the verification standard takes less than 6 min to test, the sample itself is causing the long read time. Refer to the following sections for pertinent sampling considerations. If the verification standard also takes longer than 6 min to test, the chamber may be dirty and will need to be cleaned ([Section 4.2](#)). Retest the sample after cleaning and verifying the instrument.

2.2.1.1 COATED AND DRIED SAMPLES

Samples with high sugar or fat coatings often require multiple readings because they equilibrate very slowly with the sample chamber.

Crush or slice the sample before sampling to reduce the time needed to take a water activity reading for coated or dried samples. This increases the surface area of the sample, thus decreasing reading times. However, modifying some samples may alter their water activity readings.

For example, a candy may have a soft chocolate center and a hard outer coating. The water activity reading for the center and the outer coating are different, so one would need to evaluate which part of the sample needed to be measured before crushing it. When the candy is crushed, the water activity represents the average water activity of the entire sample; leaving the candy whole gives a reading for the coating, which may act as a barrier to the center.

To reduce test time when testing whole samples, see [Section 3.2.4.2](#) for Low-Emitting mode.

2.2.1.2 LOW WATER-EMITTING SAMPLES

Some extremely dry, dehydrated, highly viscous, water-in-oil emulsions (e.g., butter), high fat, or glassy compositions may require multiple readings because of their slow water-emitting properties. The slow emission of water can be interpreted to mean that the head space is in equilibrium with the sample and cause the instrument to exit the reading prematurely.

The most effective way to test these types of samples is to run them in the AQUALAB TDL using Continuous or Custom mode and wait for the water activity readings to stabilize.

For faster reading, it is important to have the relative humidity of the chamber at or below the water activity of these types of samples. This causes the sample to release water to the vapor phase and equilibrate with the chamber. If the relative humidity of the headspace is greater than the water activity of the sample, the sample will require a long period of time to reach equilibrium.

To reduce test time when testing low water-emitting samples, see [Section 3.2.4.2](#) to set low water-emitting mode.

2.2.2 SAMPLE TEMPERATURE

The ambient temperature of the AQUALAB TDL should be between 4 and 50 °C. The AQUALAB TDL has temperature control capabilities that enable it to read samples at temperatures different from ambient temperature but no higher than 50 °C and no lower than 15 °C. Samples that are more than ± 4 °C than the instrument chamber temperature need to equilibrate to the instrument temperature before taking a reading, ideally within 1 or 2 °C of the chamber temperature. Rapid changes in temperature over short periods of time cause the water activity readings to rise or fall until the temperature stabilizes. Proceed with normal measurements when the temperature stabilizes within an optimal 1 or 2 °C of the chamber temperature.

High water activity samples that are warmer than the chamber temperature can cause condensation inside the measuring chamber, which adversely affects subsequent readings. A warning message appears if the sample temperature is more than 4 °C above chamber temperature (Figure 1).

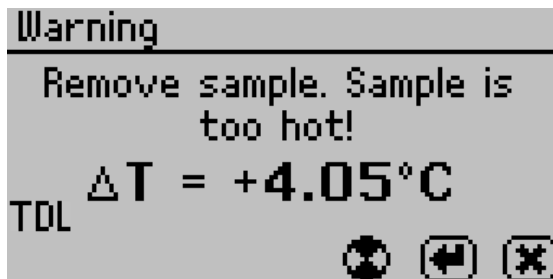

Figure 1 Sample is too hot! message

If this error message appears,

1. Remove the sample from the instrument.
2. Place a lid on the cup.
3. Allow the sample to cool to within 4 °C of the instrument before measuring.

To check the differences in temperature between the sample and the chamber prior to beginning a reading, set the sample in the chamber, close the lid without latching it, and press the **RIGHT** or **LEFT** button. Figure 2 provides an example of this screen.

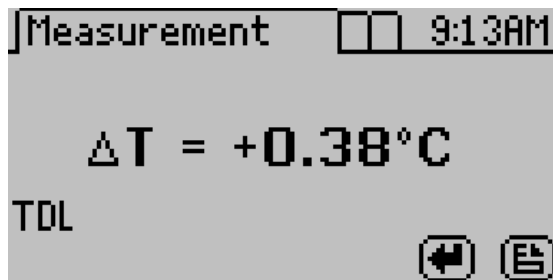

Figure 2 Temperature difference between sample and sample chamber

2.3 TAKING A READING

The AQUALAB TDL provides readings in 5 min or less. Readings are reliable, providing $\pm 0.005 a_w$ accuracy.

CAUTIONS

- Never leave a sample in the AQUALAB TDL after a reading has been taken. The sample may spill and contaminate the instrument chamber if the instrument is accidentally moved or jolted.
- Never move the instrument after a sample has been loaded. Movement may cause the sample material to spill and contaminate the sample chamber.
- Do not measure a sample that differs by more than 4 °C than the AQUALAB TDL chamber ([Section 2.2.2](#)).

Perform the following steps to take a reading.

1. Ensure the AQUALAB TDL is plugged in and turned on.
The splash screen will appear, followed by the main Measurement tab ([Section 3.2.4.1](#)).
2. Open the sample chamber by moving the lever to the OPEN position.
3. Verify cleanliness ([Section 4.2](#)), calibration ([Section 4.1](#)), and sample preparation ([Section 2.2](#)).
4. Check the top lip and outside surfaces of the sample cup to ensure they are free from sample residue and confirm the sample cup is not overfilled.

NOTE: Overfilling the sample cup may contaminate the chamber sensors.

The sample cup lid must be removed for correct functionality.

5. Place the prepared sample cup in the chamber.
6. Close the chamber lid.
7. Move the lever to the READ position to seal the chamber. The reading will automatically start.

In 1 to 2 min, the first measurement will display on the screen (this is an intermediate reading). Length of read times may vary depending on temperature differences between the chamber and the sample as well as on other properties of the sample ([Section 2.2](#)). The default AQUALAB TDL reading cycle continues until the rates of change of three consecutive intermediate readings are $<0.0005 a_w$ of each other.

When the instrument has finished its read cycle, results will display, including water activity and read time. The **SAVE** icon replaces the spinning measurement icon, and, if enabled, a series of beeps sounds ([Figure 3](#)).

NOTE: Autosave only saves the moisture content value of the model selected at the end of the reading. Overwrite the autosave by selecting the correct model using the UP and DOWN buttons and selecting SAVE.

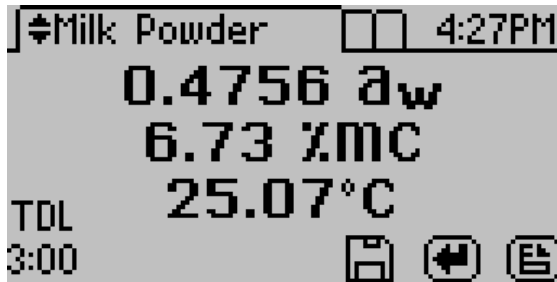

Figure 3 Completed test results with both water activity and moisture content

8. Autosave (default setting) retains the data without any annotation (Section 3.2.4.2). To add an annotation, select **SAVE**, add desired letters, and select **SAVE** again (Figure 4).



Figure 4 Keyboard screen to annotate data results

2.4 VIEWING DATA

To view prior test results, use the following steps:

1. Press **MENU** to navigate to the Data tab (Figure 5).

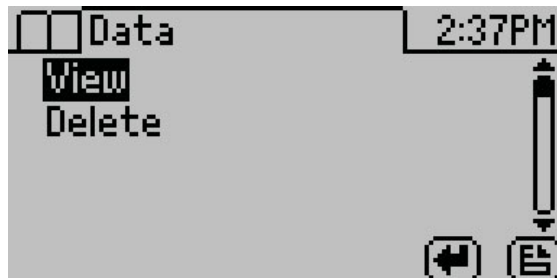

Figure 5 Data tab

2. Select **ENTER**.

3. Scroll through the list of saved tests using **UP** and **DOWN** (to move one item at a time) or **RIGHT** and **LEFT** (to move a page at a time) (Figure 6).

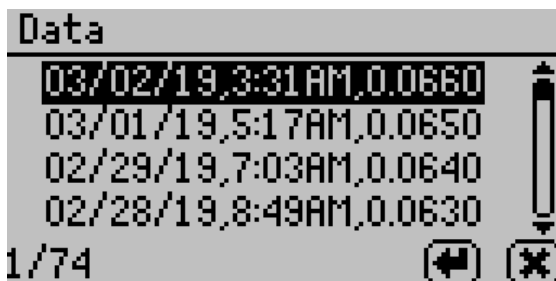

Figure 6 List of saved tests

4. Select **ENTER**.

The detailed test results screen will appear (Figure 7). Tests can also be scrolled through using the arrow buttons on this detailed screen.

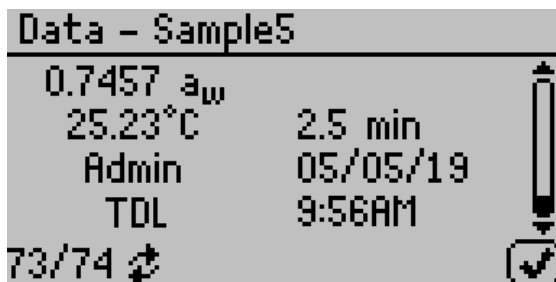

Figure 7 Detailed test results screen

5. Select **OK** to return to the list of tests.
6. Select **CANCEL** to return to the Data tab.

2.5 SETTING UP ISOTHERM-DETERMINED MOISTURE CONTENT

The relationship between water activity and moisture content is called the moisture sorption isotherm. This relationship is specific to the product type and can be modeled to allow water activity measurements to be converted to moisture content. This method provides unmatched precision when compared to traditional moisture measurement methods. All AQUALAB water activity meters can be connected to the cloud-based SKALA platform to unlock this functionality.

OPERATION

An active subscription to SKALA includes access to the METER library of existing isotherm models, allows users to manage all quality data, and enables users to perform advanced analytics. SKALA is compliant with CFR 21 Part 11 and audit ready. For more information, visit metergroup.com/food/skala-system or contact [Customer Support](#).

The AQUALAB TDL calculates moisture content values based on water activity readings using a method known as isotherm-determined moisture content. Isotherm-determined moisture content relies on models stored in the SKALA isotherm library or on a custom isotherm model provided by METER Food Lab.

Because there is no standard for dryness, moisture content results vary between reference methods. These differences are typically linear, and offsetting the model to correlate with the preferred reference method is straightforward. METER recommends offsetting the model to a primary reference method ([Section 2.5](#)).

Once a moisture model is loaded on the AQUALAB TDL, it will return a moisture content reading. Until a linear offset has been performed, this moisture content value should not be considered precise and should be discarded ([Section 2.5](#)). This reading is not a reference value that can be used to offset the model.

To assign a model to a product, follow these steps:

1. Open skalacontrol.com.
2. Select Products from the SKALA Main menu to open the Product groups page ([Figure 8](#)).

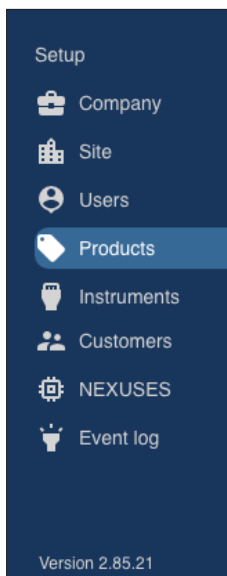

Figure 8 SKALA Main Menu

3. Select the product group that contains the product to be added as a model ([Figure 9](#)).

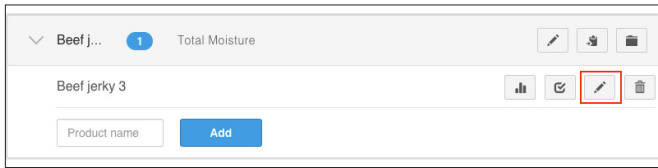

Figure 9 Select product

4. Select the product.
5. Click the edit icon on the product row (Figure 9).
The Edit Product screen should appear (Figure 10).

The screenshot shows the 'Edit product' interface with the following fields and sections:

- Product** (Section Header)
- Name:** Text input field containing 'Beef jerky 3'.
- Customer:** Dropdown menu with 'None' selected.
- Package validator:** Dropdown menu with 'None' selected.
- Shelf life:** Two input fields: '0' for 'Month(s)' and '0' for 'Day(s)'.
- Default days active:** Text input field containing '2'.
- Hourly production rate:** Text input field containing '0'.
- Max seconds of downtime:** Text input field containing '0'.
- Cost Per Gram:** Text input field containing '0'.
- Product contains volatiles:** Checkbox (unchecked).
- Disable fast aw readings:** Checkbox (unchecked).
- Buttons:** 'Add product ingredients' (blue text link).
- Section Headers:** 'PRODUCT DETAILS', 'CHECKWEIGHER SETTINGS', and 'SMOKEHOUSE SETTINGS' (each with a right-pointing chevron).
- Moisture content model:** Section header with an 'Add Model' (blue text link) button below it.
- Footer Buttons:** 'Cancel' (grey button) and 'Save' (blue button).

Figure 10 Edit Product screen

6. Scroll to the Moisture Content Model section of the Edit Product screen (Figure 10).
7. Click on the Add Model link (Figure 11).

Figure 11 Add Model

A dropdown will appear with two options:

- a. Predefined model from the SKALA isotherm library.

To set up the predefined model, follow [step 8](#).

- b. Custom model using data on the Custom Isotherm Model Coefficients sheet received from the METER Food Lab.

To set up a custom model, follow [step 9](#).

8. METER has created dozens of isotherms and compiled them into the SKALA isotherm library. Contact [Customer Support](#) with questions about the preset isotherm models.
 - a. In the dropdown box below the Moisture Content Model heading, select the Predefined model option ([Figure 12](#)).

OPERATION

Moisture content model

Predefined model 🗑️

Total Moisture -- Total Moisture

Market group: Dried Meat | Product category: Meat | Product name: Jerky

Linear offset:

Measured AW:

Measured MC:

[Add Model](#)

Figure 12 Predefined model

- b. Under Market group, select the general classification for the type of model (Figure 13).

The first time the Product is edited, the list of Market groups will be quite long. A maximum of two market groups can be selected and a dialog will appear to confirm the selections. In future sessions, the Market group dropdown will only show the two groups selected in the initial product setup.

NOTE: Once Market groups are selected, they cannot be changed without contacting [Customer Support](#).

Market group: Dried Meat

Product category: Meat | Product name: Jerky

Measured AW:

Measured MC:

Figure 13 Market group

- c. Under Product name, select the product category that most closely matches the product being measured (Figure 14).

The screenshot shows a web form for product configuration. The 'Product category' dropdown menu is open, with 'Meat' selected. Other categories visible are 'Charcuterie'. The form includes fields for 'Market group' (Dried Meat), 'Product name' (Jerky), 'Linear offset', and 'Calculate offset' button. There are also input fields for 'eg. 0.25' and 'eg. 12.34'.

Figure 14 Product category

- d. Click the **SAVE** button.

This will save the model associated with the product and close the Edit Product window, returning to the Product groups page.

- e. Before taking moisture content readings, perform a linear offset (Section 2.6).

9. To set up a custom model, the Custom Isotherm Model Coefficients sheet must be received from METER Food Lab. The information on the sheet will be added manually into SKALA. Contact [Customer Support](#) if the sheet was not received.

- a. In the dropdown box below the Moisture Content Model heading, select the Custom model option (Figure 15).

There are several isotherm model types. The Custom Isotherm Model Coefficients sheet will identify which type to use.

The screenshot shows the 'Moisture content model' selection interface. A dropdown menu is open, showing 'Predefined model' and 'Custom' options. The 'Custom' option is selected. Below the dropdown are four input fields labeled b_0 , b_1 , b_2 , and b_3 . A radio button labeled 'DLP' is also visible.

Figure 15 Custom model selection

- b. Click the radio button beside the model type identified on the Custom Isotherm Model Coefficients sheet (Figure 16).

NOTE: The DLP (double log polynomial) method is the most frequently used method.

The screenshot shows a web interface for configuring a 'Moisture content model'. At the top, there is a title 'Moisture content model'. Below it, there is a dropdown menu currently showing 'Custom'. To the right of the dropdown is a red trash icon. Below the dropdown, there is a section for 'Predefined model' which also shows 'Custom'. Underneath, there are four input fields labeled b_0 , b_1 , b_2 , and b_3 . To the left of these fields is a radio button labeled 'DLP'.

Figure 16 Custom model type and coefficients

- c. Fill in the data fields by matching each field with the values on the Custom Isotherm Model Coefficients sheet.
NOTE: It is extremely important that the radio button remains activated or entered data will be lost.
- d. Click the **SAVE** button.
- e. This will save the model associated with the product and close the Edit Product window, returning to the Product groups page.
- f. Before taking moisture content readings, perform a linear offset ([Section 2.6](#)).

2.6 PERFORMING A LINEAR OFFSET

A linear offset must be performed every time a new model is implemented. In addition, the linear offset should be adjusted if moisture content values calculated by the AQUALAB TDL are consistently higher or lower than reference method values over several samples.

To perform a linear offset, select a reference moisture content method to use. Acceptable moisture content reference methods include ROS 1, loss-on-drying, and Karl Fischer titration. Secondary methods have increased margins of error, which will in turn increase the error in AQUALAB 3 moisture content measurements. If desired, an offset can be set to a secondary method (e.g., fast moisture analyzer, microwave analyzer, or NIR) to compare results with a previously used method.

To perform the linear offset, follow these steps:

1. Ensure the instrument is verified ([Section 4.1](#)).
2. Collect a large sample of the product for analysis.
3. Divide the large sample into three subsamples, ensuring that each is representative of the larger sample.
4. Place one subsample into a sample cup.

5. Read the water activity using the AQUALAB TDL (Section 2.5) and make a note of the water activity value.

This will be used in [step 13](#).

NOTE: The moisture content value has not yet been properly offset and should be ignored.

6. Use the reference method to determine the average moisture content of the other two subsamples.

This average is the reference moisture content value. This will be used in [step 14](#).

7. Open skalacontrol.com.

NOTE: Linear offsets must be performed on a product-by-product basis in the SKALA Control desktop application. This functionality does not appear in the SKALA Mobile app.

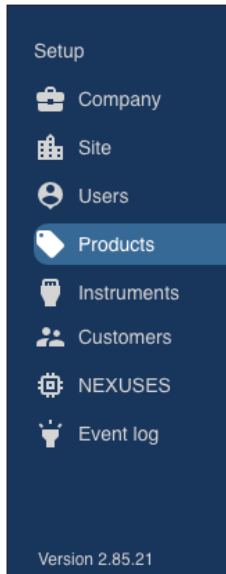

Figure 17 SKALA Main Menu

8. Select Products from the SKALA Main menu.
9. Select the Product group containing the product to be offset ([Figure 18](#)).

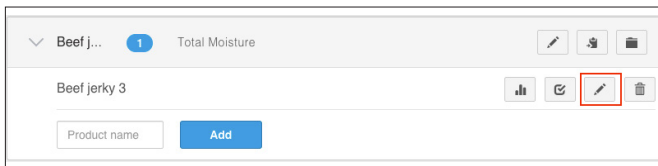
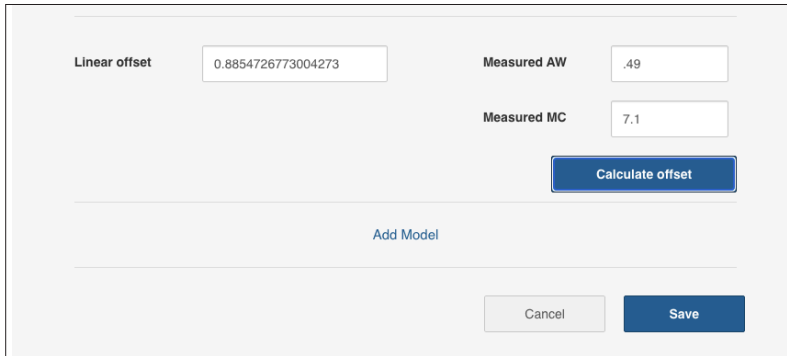

Figure 18 Product group

10. Click the edit icon next to the product to be offset ([Figure 18](#)).

OPERATION

11. Make sure the model has been selected or set as instructed in (Section 2.5).
12. In the Moisture Content Model portion of the Edit Product screen, scroll down to the Linear offset section (Figure 19).



The screenshot shows a form with the following fields and buttons:

- Linear offset**: Input field containing the value 0.8854726773004273.
- Measured AW**: Input field containing the value .49.
- Measured MC**: Input field containing the value 7.1.
- Calculate offset**: A blue button.
- Add Model**: A blue link.
- Cancel**: A light gray button.
- Save**: A dark blue button.

Figure 19 Linear offset section

13. Enter the product water activity from [step 5](#) into the Measured AW field.
14. Enter the reference moisture content value from [step 6](#) into the Measured MC field.
15. Do NOT enter a value into the Linear Offset field.
This value will be calculated in SKALA Control from the numbers entered as Measured AW and Measured MC.
16. Click the **Calculate offset** button.
An offset value will appear in the Linear offset field.
17. Click the **Save** button.

3. SYSTEM

This section describes the AQUALAB TDL Water Activity Meter.

3.1 SPECIFICATIONS

MEASUREMENT SPECIFICATIONS

Water Activity	
Range	0.000–1.000 a_w
Resolution	0.0001 a_w
Accuracy	±0.005 at 25 °C
Repeatability	±0.001 a_w
Temperature	
Range	15–50 °C
Resolution	0.01 °C
Accuracy	±0.1 °C
Adjustment Increment	1 °C
Read Time	
	~5 min

PHYSICAL SPECIFICATIONS

Case Dimensions	
Length	26.7 cm (10.5 in)
Width	17.8 cm (7.0 in)
Height	12.7 cm (5.0 in)
Case Material	
	POLYLAC PA-765 (ABS) with fire retardant
Sample Cup Capacity	
	14 mL (0.47 fl oz)
Weight	
	3.1 kg (6.8 lb)

Display

64 × 128 graphical

Operating Temperature

Minimum 4 °C

Typical 23 °C

Maximum 50 °C

Operating Environment

0%–90% RH noncondensing

Data CommunicationsUSB A and RS-232 serial
9,600–115,000 baud**Power**110–220 VAC
50/60 Hz**COMPLIANCE**

Manufactured under ISO 9001:2015

EM ISO/IEC 17050:2010 (CE Mark)

3.2 COMPONENTS

The AQUALAB TDL uses a tunable diode laser to measure the water activity of a sample. The sample is equilibrated with the headspace of a sealed chamber containing a tunable laser that shines light of a controlled wavelength at a detector that receives the light from the laser. At equilibrium, the relative humidity of the air in the chamber is the same as the water activity of the sample. In the AQUALAB TDL, the vapor pressure of the headspace in equilibrium is determined by the attenuation of signal strength from the laser caused by the presence of water vapor in the headspace. This vapor pressure is divided by the saturated vapor pressure at the sample temperature, which is measured using an infrared (IR) sensor, to give water activity. The AQUALAB TDL displays the final water activity.

The AQUALAB TDL main components include the display screen and sample chamber (Figure 20).

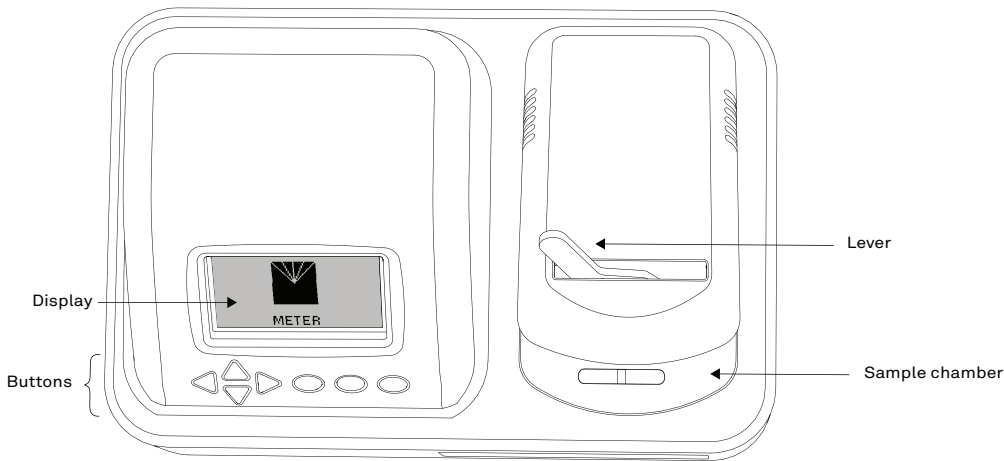

Figure 20 AQUALAB TDL exterior

3.2.1 CORDS AND CABLES

The AQUALAB TDL comes with a power cord and a USB cable.

The power cord plugs into the back of the instrument and must be plugged into a grounded outlet or power strip.

WARNING: Only use the supplied power cord or one rated for AQUALAB TDL and certified for the country of use. The cord must be a minimum of 18 AWG and have a rating for 10 A or greater.

The USB cable has one USB A connector to connect to a computer and one USB B connector to connect to the AQUALAB TDL. The data from the AQUALAB TDL can be saved to the computer with this connection. An RS-232-to-USB cable may also be used but is not included.

3.2.2 SAMPLE CHAMBER

The lever has two positions: OPEN (handle moved to the right) and READ (handle moved to the left).

Internally, there are two blocks within the sample chamber: an upper lid block and a lower sample block (Figure 21). The blocks are temperature controlled and regulate the temperature of the sample and sample chamber.

SYSTEM

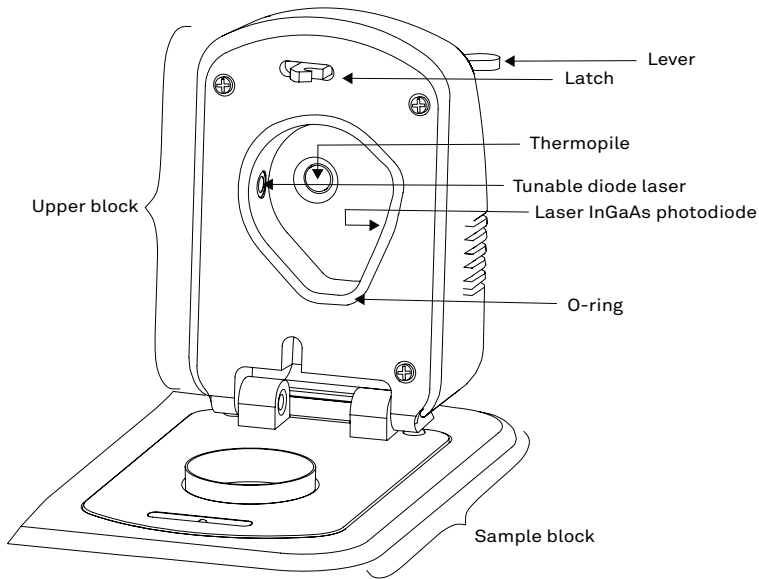

Figure 21 Sample chamber interior

3.2.3 BUTTONS

The power switch is located on the lower left corner of the AQUALAB TDL back panel. After being turned on, the AQUALAB TDL should warm up for 15 min before operation to ensure accurate readings.

There are four arrow buttons: **LEFT**, **RIGHT**, **UP**, and **DOWN** (Figure 22). These buttons allow for navigation through the various screens on the AQUALAB TDL. The three round buttons have variable uses, depending on what icon is represented above them on the display (Section 3.2.3).

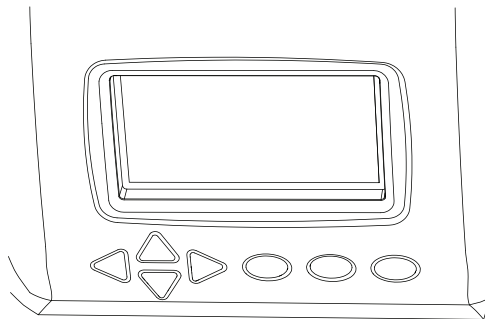

Figure 22 AQUALAB TDL front display buttons

3.2.4 DISPLAY SCREEN

The display screen ([Figure 23](#)) has three tabs: Measurement, Configuration, and Data.

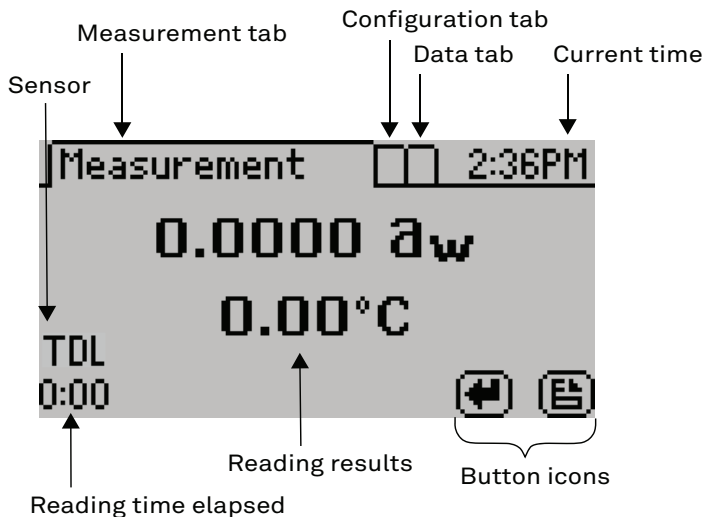









Figure 23 Display screen

The button icons on the display change to show the available actions for the screen ([Table 2](#)).

Table 2 AQUALAB TDL button icons

Icon	Name	Action
	ENTER	Accepts the current action
	CANCEL	Ends the current action
	MENU	Switches between the Measurement, Configuration, and Data tabs
	SAVE	Saves a setting or a reading
	OK	Accepts the input from the user
	AUDIO OFF	Silences beeping
	AUDIO ON	Enables beeping

3.2.4.1 MEASUREMENT TAB

The Measurement tab (Figure 24) is the main screen and must be visible to start a reading. Measurement results are displayed on this screen.

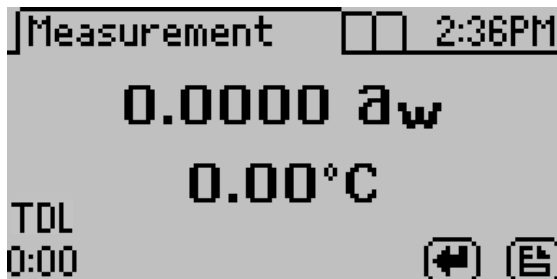

Figure 24 Measurement tab

Using the **RIGHT** or **LEFT** buttons changes the display to a temperature equilibration screen (Figure 25). This screen shows the temperature difference between the sample and the lid.

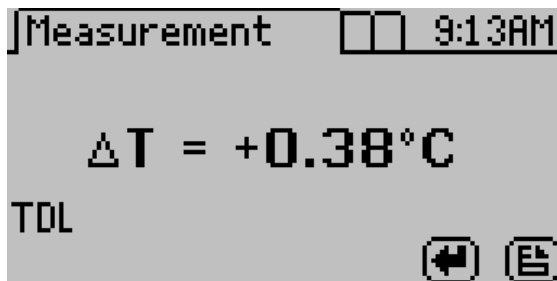
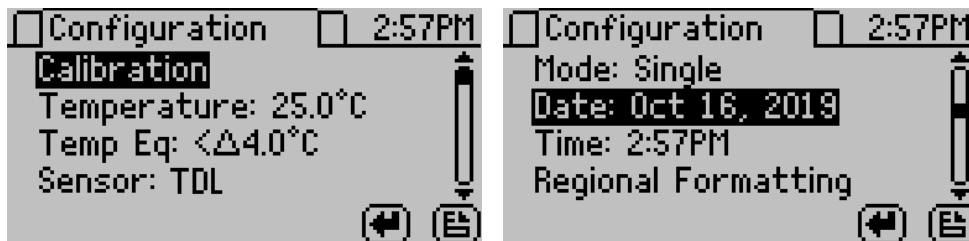

Figure 25 Temperature equilibration

3.2.4.2 CONFIGURATION TAB

The Configuration tab provides a menu of configuration options (Figure 26). Use **UP** and **DOWN** to move the selection through the various configuration options or **LEFT** and **RIGHT** to page through the options. Use **ENTER** to select the highlighted option.



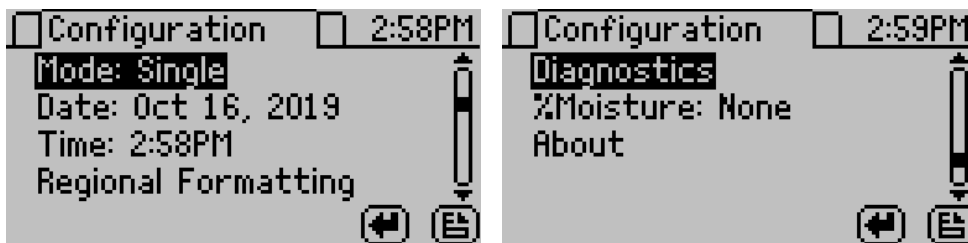

Figure 26 Configuration tab screens

- **Calibration.** Select to start the calibration process (Section 4.1) for water activity or moisture content (Figure 27). Resetting factory defaults is described in Section 4.1.4.

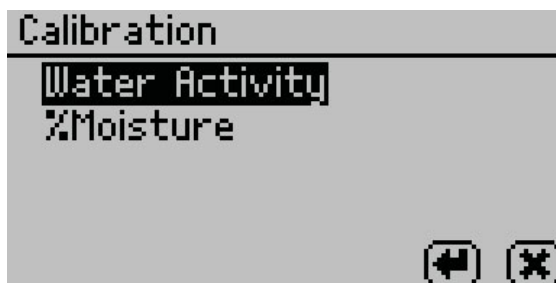

Figure 27 Calibration option

- **Temperature.** Select to set the AQUALAB TDL to the desired temperature using UP and DOWN. When finished, select SAVE (Figure 28).

The AQUALAB TDL may be set between 15 and 50 °C in 1.0 °C intervals. The default temperature is 25 °C.

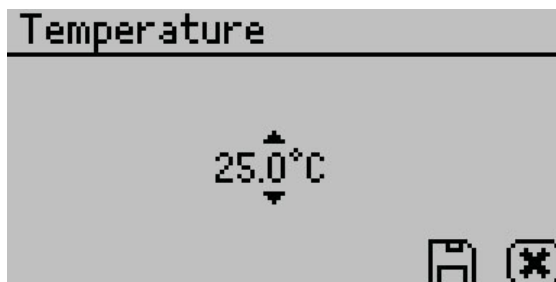

Figure 28 Temperature option

- **Temp Eq.** Select to set the acceptable temperature difference between the AQUALAB TDL block and the sample before starting a water activity measurement (Figure 29).

The range is 0.1 to 4.0 °C. A setting of 4.0 °C begins the measurement when the sample is <4.0 °C above or below the block temperature. A setting of 0.1 °C begins the measurement when the sample is <0.1 °C above or below the block temperature.

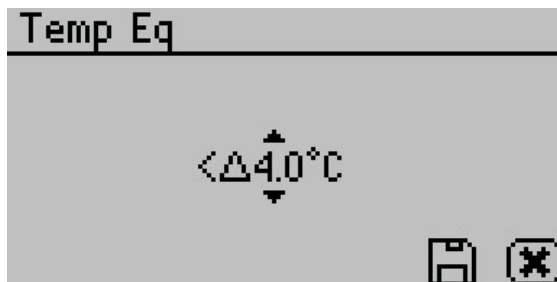

Figure 29 Temp Eq

- **Sensor.** This displays the TDL sensor as the active sensor on the Measurement tab. This configuration option is not editable.
- **Mode.** Select to choose between Single, Continuous, Custom, or Low-Emitting mode (Figure 30). The current mode settings appear at the top of the screen with the number of tests appearing first, followed by the stability value (Δa_w).

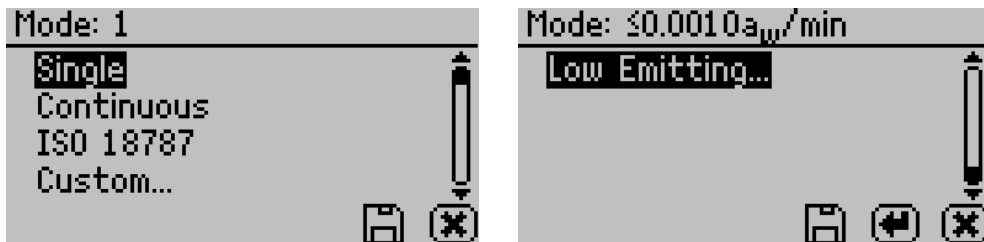

Figure 30 Mode options

- Single mode reads the sample once.
- Continuous mode reads the sample until the chamber lid is opened or the test is stopped using the **CANCEL** button.
The AQUALAB reads the sample, displays results, and begins another read cycle without further action from the user. The machine signals the completion of each reading with a beep. A timer on the screen tracks the cumulative read time.
All readings taken during Continuous mode are saved on the instrument memory if the autosave feature is turned on (default).
- ISO 18787 mode reads the sample until the water activity change is equal to or less than $0.0003 a_w$ per minute.
- Custom mode reads a sample multiple times until a set level of stability is achieved. For example, the instrument could be set to read the sample until four consecutive tests are within $\pm 0.001 a_w$ of each other.

Use **RIGHT** and **LEFT** to change between the Readings or Δa_w settings.

Use **UP** and **DOWN** to change to select the number of readings (2 to 9).

Use **UP** and **DOWN** to select the Δa_w value (any number from 0.0005 to 0.0200) (Figure 31).

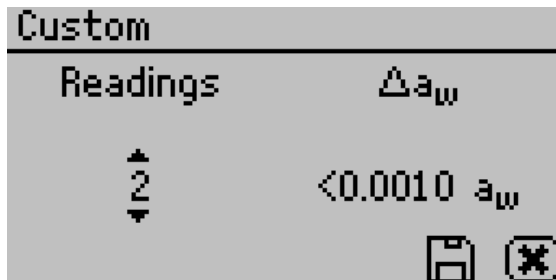

Figure 31 Custom mode screen

Select **SAVE** to update and exit. Select **CANCEL** to exit without updating. The Mode screen now appears with the updated custom settings appearing at the top of the screen.

If autosave is turned on (default), all test readings will save to the instrument memory, but only the final reading will remain on the Measurement screen.

- ♦ Low-Emitting mode gives the option of speeding up test time by adjusting the equilibrium trigger value (Figure 32). This mode is for samples that are slow to equilibrate such as vegetable oils, high fat samples, and high viscosity samples.

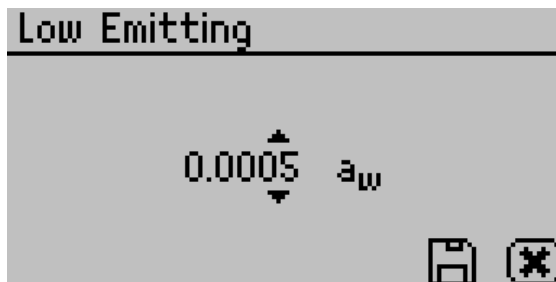

Figure 32 Low-Emitting mode

AQUALAB TDL determines vapor equilibrium at the end of a test by comparing sequential water activity values, looking for a trigger value difference $<0.0005 a_w$. This value can be adjusted to any value between 0.0003 and 0.0030 a_w . Increasing the trigger value causes a subsequent reduction in instrument accuracy and precision but results in a shorter test time. This mode is for samples that are slow to equilibrate, such as vegetable oils, high-fat samples, and high-viscosity samples. In these types of cases, the loss in performance may be acceptable in order to speed up the analysis time. Use a high trigger value only after careful consideration of the impact on test results.

- **Date.** Select to set the date in the instrument. Use **RIGHT** and **LEFT** to change between the month, day, and year categories and **UP** and **DOWN** to change the individual values (Figure 33). The date is recorded with each water activity reading.



Figure 33 Date option

- **Time.** Select to set the time in the instrument. Use **RIGHT** and **LEFT** to change between the hour and minute categories and **UP** and **DOWN** to change the individual values (Figure 34). The hour setting automatically changes between **AM** and **PM**.

The time is recorded with each water activity reading.

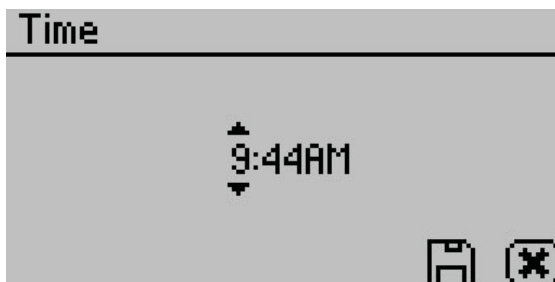

Figure 34 Time option

- **Regional Formatting.** Select to configure how the AQUALAB TDL displays information (Figure 35). Choose the temperature scale (Celsius or Fahrenheit), the date display (mm/dd/yy or dd/mm/yy), the hour format (12 or 24 h), and the language.

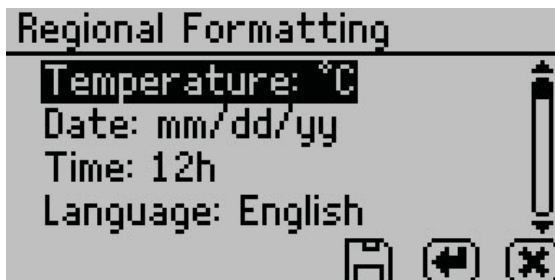

Figure 35 Regional Formatting option

- **Admin Settings.** Select to configure the administrator password, configure users, and specify salt standards for multipoint calibrations. (Figure 36).

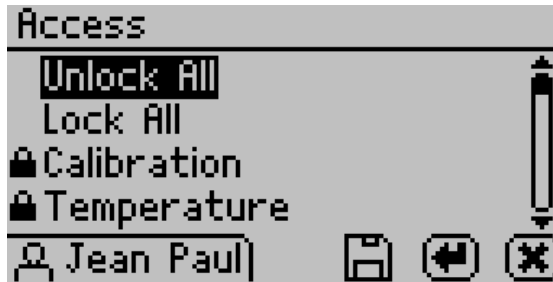

Figure 36 Admin Settings option

NOTE: Once the administrator is set up, the password cannot be recovered. The AQUALAB TDL must be sent back to METER to be reset.

Administrators can add, edit, or delete users from the User Setup screen. The keyboard screen allows for lowercase, uppercase, and accented letters (Figure 37).

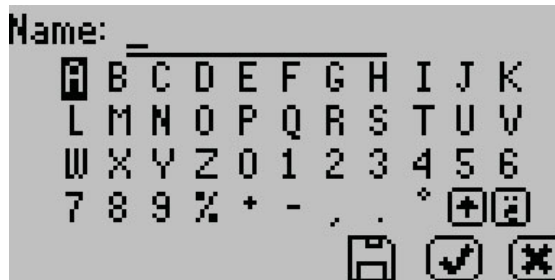

Figure 37 Keyboard screen

NOTE: User setup is not required for instrument operation. It is in place for users requiring 21 CFR Part 11 compliance or who want to save specific settings.

Once the administrator and users are set up, an Access option will appear on individual user screens (Figure 38).



Figure 38 Access option on a user screen

To lock out users from accessing certain settings, enter the Access function and use **UP** and **DOWN** to find the desired option. Selecting the option will toggle it locked or unlocked: calibration, temperature, temperature equilibration, sensor selection, mode, date/time, region, password, autosave, number of beeps, and delete (Figure 39). These options can also be all locked or unlocked at the same time.



Figure 39 Access settings

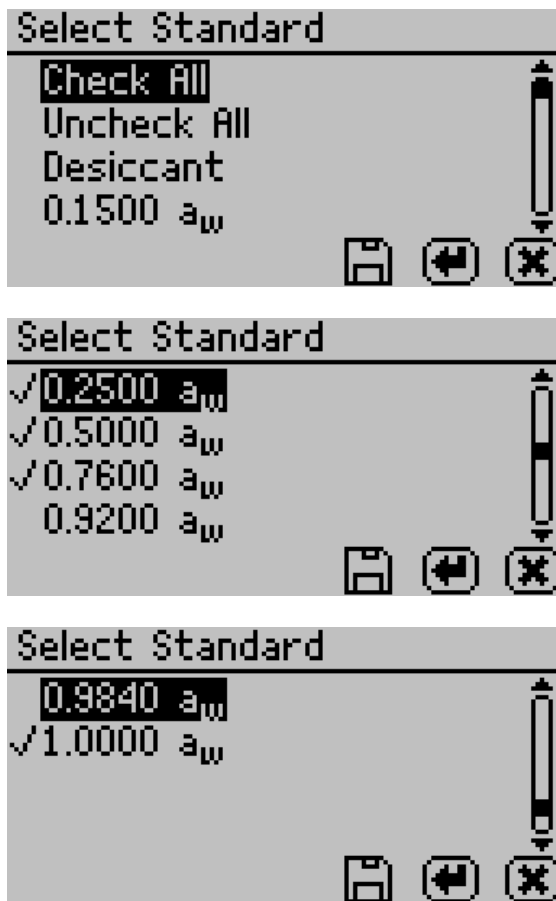

Figure 40 Multipoint standard screens

- Multipoint Standard.** From this screen (in firmware v3.3.0 and newer) select the salt standards that are required for all subsequent multipoint calibrations. To check or uncheck a salt standard, use **UP** or **DOWN** to find the desired option. Press the **ENTER** button to toggle the checkmark to the left of the salt standard. These options can be all checked or unchecked at the same time. All salt standards that are checked will be used during the multipoint calibration process. Once the desired salt standards are checked, press the save button to **SAVE** the multipoint salt standards or the **CANCEL** button to cancel changes.
- Autosave.** Select to turn Autosave on or off. Autosave stores water activity readings within the instrument automatically for every water activity reading in the internal memory. The AQUALAB TDL can store up to 8,000 records before the memory is full.

Any individual reading may be saved manually right after completing the test and before beginning the next test, regardless of the Autosave setting.

NOTE: If a reading is autosaved, it is not possible to give it an annotation later.

- **Beeps.** Select to change the number of notification beeps for a finished test (four, continuous, or no beeps). The audible notification can be turned off.
- **Print Mode.** Select to change the information printed out over the serial port to one of the following options:
 - ♦ Off: Turns off printing out the serial port after a reading has completed. Ideal for use with SKALA Hub systems.
 - ♦ On: Turns on basic printing after a reading is completed. Reports reading duration (in minutes), sample temperature (in Celsius), and water activity.
 - ♦ Detailed: Turns on detailed printing after a reading is completed including the date (ddmm-yy), 24-h time (HH:MM), instrument serial number, reading duration (in minutes), sample temperature (in Celsius), and water activity.

NOTE: When a Brecknell printer is connected, setting the print mode to On will keep the printer time synchronized with the AQUALAB. Setting the print mode to Detailed will disable the printer date and time header and instead use the time directly from the AQUALAB instrument.

- **Diagnostics.** Select to view AQUALAB TDL information (Figure 41).

Diagnostics screen provides lid, base, sample and laser temperatures, laser intensity, atmospheric pressure, and water activity offset. Figure 41 shows typical values for the sensors.

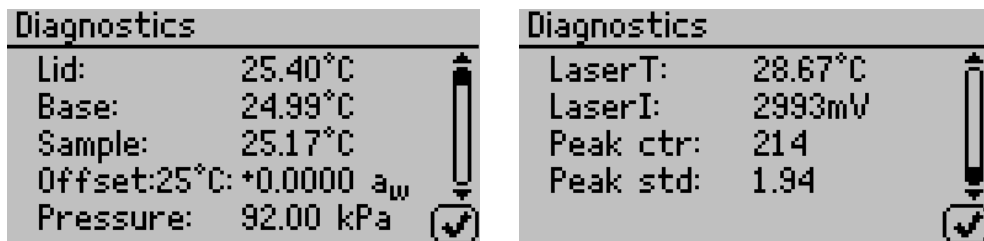

Figure 41 Diagnostics screens

- **%Moisture.** Select which moisture content model to use to calculate moisture content.
- **About.** Select to view instrument information including the serial number and firmware code version of the instrument (Figure 42).



Figure 42 About screen

3.2.4.3 DATA TAB

Data can be viewed or deleted from the Data tab (Figure 43).

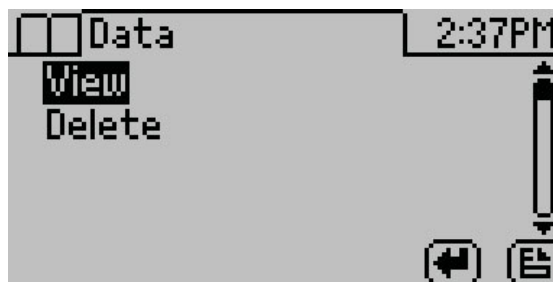

Figure 43 Data tab

- **View.** Select to view stored measurements with the most recent measurements at the top of the table (Figure 44). Use **UP** and **DOWN** to move through the stored data. Use **LEFT** and **RIGHT** to page quickly through the data.

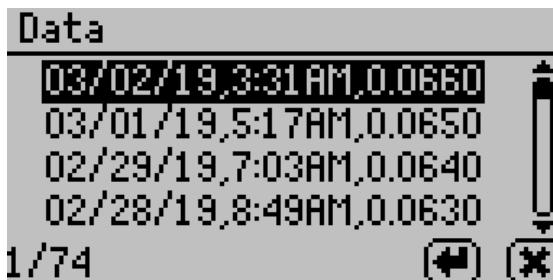

Figure 44 View data summary

Select a highlighted reading to view detailed information (Figure 45).

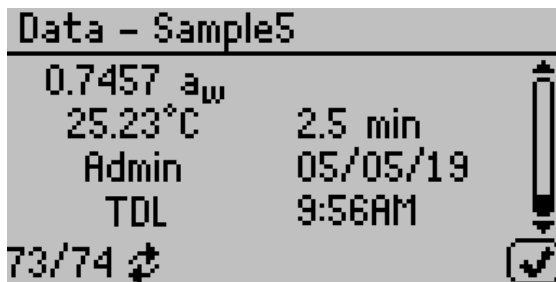

Figure 45 Data sample detail screen

The screen displays the name of the reading (if annotated), the water activity of the sample, the temperature of the sample, the test time, the user who ran the test (if set up), the reading date, the sensor used, the time the reading was taken, and the sequence number of the stored reading. Use **UP** and **DOWN** to scroll through readings.

- **Delete.** Select this option to delete all data currently stored in the instrument. Readings cannot be deleted individually. If the information has not been backed up, a reminder will appear (Figure 46).

NOTE: Deleted data cannot be recovered.

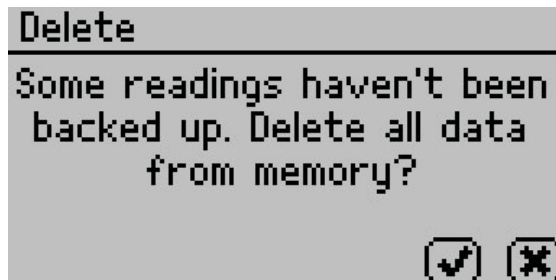

Figure 46 Delete option backup reminder dialog

3.3 THEORY

Water is a major component of foods, pharmaceuticals, and cosmetics and influences the product texture, appearance, flavor, and shelf life. Quantifying these attributes require two basic types of water analysis: moisture content and water activity (a_w).

3.3.1 WATER ACTIVITY

Water activity (a_w) is a measurement of the energy status of the water in a system. The value indicates how tightly water is bound, structurally or chemically, within a substance. The concept of water activity is of particular importance in determining product quality and safety. It predicts safety and stability with respect to microbial growth, chemical and biochemical reaction rates, and physical properties.

Water activity is a measure of the energy status of the water in a system and is a far better indicator of perishability than moisture content. Figure 47 shows how the relative activity of microorganisms, lipids, and enzymes relate to water activity. While other factors, such as nutrient availability, temperature, and pH, can affect the relationships, water activity is the best single measure of how water affects these processes.

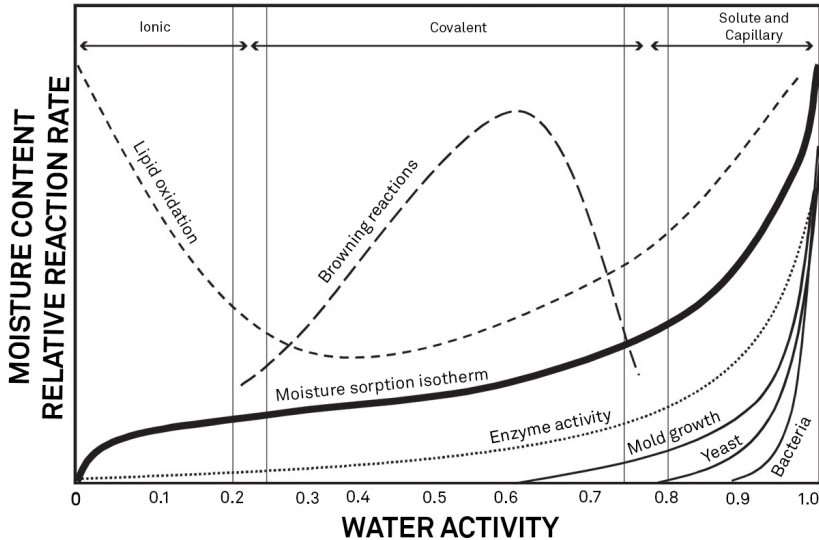

Figure 47 Water activity diagram adapted from Labuza

Researchers measure the water activity of a system by equilibrating the liquid phase water in the sample with the vapor phase water in the headspace and measuring the relative humidity of the headspace. In the AQUALAB TDL, a sample in a sample cup is sealed inside the sample chamber, which contains a tunable diode laser and an infrared thermometer. The AQUALAB TDL determines the vapor pressure in the headspace and the infrared thermometer measures the sample temperature. From these measurements, the relative humidity of the headspace is computed as the ratio of the partial pressure measured by the AQUALAB TDL to saturation vapor pressure at the sample temperature. When the water activity of the sample and the relative humidity of the air are in equilibrium, the measurement of the headspace humidity gives the water activity of the sample.

In addition to equilibrium between the liquid phase water and the vapor phase, the internal equilibrium of the sample is important. If a system is not at internal equilibrium, one might measure a steady vapor pressure (over the period of measurement) which is not the true water activity of the system. An example of this might be a baked good or a multicomponent food. Initially out of the oven, a baked good is not at internal equilibrium; the outer surface is at a lower water activity than the center of the baked good. One must wait a period of time in order for the water to migrate and the system to come to internal equilibrium. It is important to remember the restriction of the definition of water activity to equilibrium.

The water activity of the water in a system is influenced by factors that affect the binding of water. They include osmotic, matric, and pressure effects. Typically, water activity is measured at atmospheric pressure, so only the osmotic and matric effects are important.

3.3.1.1 TEMPERATURE EFFECTS

Temperature plays a critical role in water activity determination. The AQUALAB TDL infrared thermometer measures the difference in temperature between the sample and the block. It is carefully calibrated to minimize temperature errors, but when temperature differences are large, water activity can change during testing. Best accuracy is therefore obtained when the sample is near chamber temperature.

Another effect of temperature on water activity occurs when samples are near saturation. A sample that is close to 1.0 a_w and is warmer than the sensor block will cause water to condense within the chamber. This causes errors in the measurement and in subsequent measurements until the condensation disappears. For example, a sample at 0.75 a_w only needs to be approximately 4 °C above the chamber temperature to cause condensation to form. The AQUALAB TDL warns the user if a sample is more than 4 °C above the chamber temperature, but for high water activity samples, the operator needs to be aware that condensation can occur if a sample that is warmer than the block is put in the AQUALAB.

Samples not read at room temperature during the read cycle equilibrate with the AQUALAB TDL temperature before the water activity is displayed. Large temperature differences cause longer reading times, since the AQUALAB TDL cannot make a complete and accurate reading until the sample and the instrument equilibrate to within 4 °C.

There are several advantages in having a temperature-controlled water activity meter. A few major reasons are:

1. Research purposes.

Researchers can use temperature control to study the effects of temperature on the water activity of a sample, make a comparison of the water activity of different samples independent of temperature, and conduct accelerated shelf-life studies or other water activity studies where temperature control is critical. There are many shelf-life, packaging, and isotherm studies in which temperature control would be very beneficial.

2. Compliance with government or internal regulations for specific products.

Though the water activity of most products varies by less than ± 0.02 per $1\text{ }^{\circ}\text{C}$, some regulations require measurement at a specific temperature. The most common specification is $25\text{ }^{\circ}\text{C}$, though $20\text{ }^{\circ}\text{C}$ is sometimes indicated.

3. Minimization of extreme ambient temperature fluctuations.

If the environmental and AQUALAB TDL temperatures fluctuate by as much as $\pm 5\text{ }^{\circ}\text{C}$ daily, water activity readings vary by $\pm 0.01 a_w$. Temperature control eliminates variations due to changes in ambient conditions.

The AQUALAB TDL has thermoelectric components installed to allow the instrument to maintain a set chamber temperature. The temperature of the instrument can be changed in the Configuration tab.

3.3.1.2 OSMOTIC EFFECTS

Osmotic effects are well known from biology and physical chemistry. Water is diluted when a solute is added. If this diluted water is separated from pure water by a semipermeable membrane, water tends to move from the pure water side through the membrane to the side with the added solute. If sufficient pressure is applied to the solute-water mixture to just stop the flow, this pressure is a measure of the osmotic potential of the solution. The addition of 1 mol of an ideal solute to 1 kg of water produces an osmotic pressure of 22.4 atm. This lowers the water activity of the solution from 1.0 to 0.98 a_w . For a given amount of solute, increasing the moisture content of the systems dilutes the solute, decreasing the osmotic pressure, and increasing the water activity. Since microbial cells are high concentrations of solute surrounded by semipermeable membranes, the osmotic effect on the free energy of the water is important for determining microbial water relations and therefore microbe activity.

3.3.1.3 MATRIX EFFECTS

The sample matrix affects water activity by physically binding water within its structure through adhesive and cohesive forces that hold water in pores and capillaries and to particle surfaces. If cellulose or protein were added to water, the energy status of the water would be reduced. Work would need to be done to extract the water from this matrix. This reduction in energy status of the water is not osmotic, because the cellulose or protein concentrations are far too low to produce any significant dilution of water. The reduction in energy is the result of direct physical binding of water to the cellulose or protein matrix by hydrogen bonding and van der Waals forces. At higher water activity levels, capillary forces and surface tension can also play a role.

3.3.2 WATER POTENTIAL

Water activity is closely related to a thermodynamic property called the water potential, or chemical potential (μ) of water, which is the change in Gibbs free energy (ΔG) when water concentration changes. Equilibrium occurs in a system when μ is the same everywhere in the system. Equilibrium between the liquid and the vapor phases implies that μ is the same in both phases. This means the measured water potential of the vapor phase can be used to determine the water potential of the liquid phase. Gradients in μ are driving forces for

moisture movement. In an isothermal system, water tends to move from regions of high water potential (high a_w) to regions of low water potential (low a_w). Moisture content is not a driving force for water movement and, therefore, cannot be used to predict the direction of water movement, except in homogeneous materials.

3.3.3 MOISTURE CONTENT

Moisture content implies a quantitative analysis to determine the total amount of water present in a sample. There are two primary methods for determining moisture content: loss on drying and Karl Fisher titration. Secondary methods, such as near infrared (NIR) and nuclear magnetic resonance (NMR), may also be used. Moisture content determination is essential in meeting product nutritional labeling regulations, specifying recipes, and monitoring processes.

However, moisture content alone is not a reliable indicator for predicting microbial responses and chemical reactions in materials. The limitations of moisture content measurement are attributed to differences in the intensity with which water associates with other components.

3.3.4 SORPTION ISOTHERMS

Changes in moisture content affect both the osmotic and matric binding of water in a product. Thus, a relationship exists between the water activity and moisture content. This relationship is called the sorption isotherm and is unique for each product. Besides being unique to each product, the isotherm changes depending on whether it was obtained by drying or wetting the sample. Typically, large safety margins are built into moisture content specifications to allow for these uncertainties.

While the sorption isotherm is often used to infer water activity from moisture content, one could easily go the other direction and infer moisture content from water activity. This is particularly attractive because water activity can be measured much more quickly than moisture content. This method gives particularly good precision in the center of the isotherm. In order to infer moisture content from water activity, an isotherm for the particular product is needed. METER sells an isotherm generator called the AQUALAB Vapor Sorption Analyzer (VSA) or METER can run the isotherm for a fee. Visit metergroup.com/food/services/water-activity-and-isotherm-testing or contact [Customer Support](#) for more information.

4. SERVICE

This section describes the calibration and maintenance of the AQUALAB TDL. Troubleshooting solutions and customer service information are also provided.

4.1 VERIFICATION AND CALIBRATION

It is important to verify the AQUALAB TDL water activity calibration against known standards to guarantee optimal performance and accuracy. METER recommends verification or once per shift or daily before use.

METER also recommends annual factory calibration to maintain optimal performance.

4.1.1 WATER ACTIVITY VERIFICATION

The AQUALAB TDL uses the tunable diode laser technique to determine water activity. The components used by the instrument to measure water activity are subject to contamination, which may affect AQUALAB TDL performance. Therefore, frequent verification assures that the AQUALAB TDL is performing correctly. In addition, providing a linear offset can be used to overcome any additional instrument drift.

VERIFICATION STANDARDS

Verification standards are specially prepared, unsaturated salt solutions having a specific molality and water activity value that are accurately measurable. The verification standards sent with the initial shipment are very accurate and available from METER. Using verification standards to verify accuracy can greatly reduce preparation errors. Verification standards come in seven water activity levels: 1.000, 0.984, 0.920, 0.760, 0.500, 0.250, and 0.150 (Table 3). The standards are produced under a strict quality assurance regime.

Table 3 Verification standards

Verification Standard at 25 °C	a_w
17.18 mol/kg LiCl	0.150 ±0.005
13.41 mol/kg LiCl	0.250 ±0.003
8.57 mol/kg LiCl	0.500 ±0.003
6.00 mol/kg NaCl	0.760 ±0.003
2.33 mol/kg NaCl	0.920 ±0.003
0.50 mol/kg KCl	0.984 ±0.003
Steam Distilled Water	1.000 ±0.003

NOTE: Safety Data Sheet (SDS) for these standards are available at [metergroup.com/food/meter-safety-data-sheets](https://www.metergroup.com/food/meter-safety-data-sheets).

To use a verification standard, remove the twist top and puncture the foil cap. Pour the contents into a sample cup.

NOTE: To avoid inaccurate water activity readings, verification standards should be used once immediately after opening. Do not store standards in sample cups for repeated use.

VERIFICATION OF CALIBRATION

Verification of the calibration should be performed regularly to ensure the AQUALAB is operating within specification. METER recommends verification be run once per shift or prior to operation. The procedure for verification involves reading a sample of known water activity. METER recommends using a standard close to that of the sample being measured.

Checking the water activity of a standard solution checks for the possibility of unit contamination or shifts in the linear offset from other causes.

The following steps explain how to verify for linear offset of the AQUALAB TDL (Figure 48).

1. If measuring samples over a wide range of water activity values, select two standards that best bracket the region. If measuring a relatively narrow region, select a sample that most closely matches the sample range being measured.

For example, if testing for water activity readings ranging between 0.621 and 0.713, use the 8.57 mol/kg LiCl (0.500 a_w) standard for the first verification and the 6.00 mol/kg NaCl (0.760 a_w) for the second verification.

NOTE: The AQUALAB TDL needs to warm up for approximately 15 min to make accurate readings.

2. Empty a vial of the lower water activity verification standard into a sample cup.
3. Place it in the AQUALAB TDL testing chamber. Make sure that the standard is as close to the instrument temperature as possible (Section 2.2.2).

NOTE: Make sure the rim and outside of the sample cup are clean.

4. Carefully close the lid and move the lever to the READ position.
5. Take two readings.

The water activity readings should be within $\pm 0.005 a_w$ of the given value for the verification standard. The standards will read at 25 °C. If other temperatures are required, refer to Table 4.

Table 4 Temperature correction of verification standards

Temperature (°C)	Water	0.50 mol/kg KCL	2.33 mol/kg NaCl	6.00 mol/kg NaCl	8.57 mol/kg LiCl	13.41 mol/kg LiCl	17.18 mol/kg LiCl
15	1.000	0.984	0.923	0.761	0.492	0.238	0.140
20	1.000	0.984	0.922	0.760	0.496	0.245	0.145
25	1.000	0.984	0.920	0.760	0.500	0.250	0.150
30	1.000	0.984	0.920	0.760	0.504	0.255	0.155
35	1.000	0.984	0.920	0.760	0.508	0.261	0.160
40	1.000	0.984	0.921	0.760	0.512	0.266	0.165
50	1.000	0.984	0.894	0.740	0.517	0.275	0.172

6. The readings may lead to one of three outcomes.
 - a. If the AQUALAB TDL reads within $\pm 0.005 a_w$ of the first verification standard, take two readings of the second verification standard. The second water activity reading for the second verification standard should be within $\pm 0.005 a_w$.
 - b. If either verification standard is not correct, it is probably due to contamination of the sensor chamber. Clean and air out the chamber ([Section 4.2](#)) and repeat verification from [step 2](#).
 - c. If readings are consistently outside the water activity of the first verification standard by more than $\pm 0.005 a_w$, a linear offset can be applied. Adjust the reading to match the correct verification standard value ([Section 4.1.2](#)).

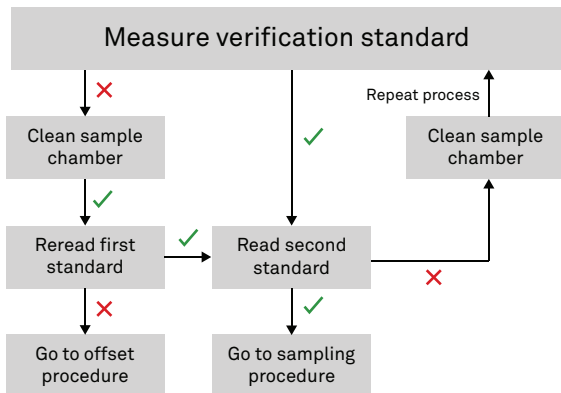

Figure 48 Verification standard flowchart. A check indicates AQUALAB TDL verified the standard within specification; a cross indicates AQUALAB TDL did not verify the standard within specifications.

4.1.2 LINEAR OFFSET

After verification and cleaning the instrument, an offset may be necessary.

NOTE: A linear offset does not adjust the calibration for all water activity levels and should only be used if measuring water activity in a very small range.

1. Navigate to the Configuration tab.
2. Select Calibration.
3. Select Water Activity.
4. Select Start ([Figure 49](#)).

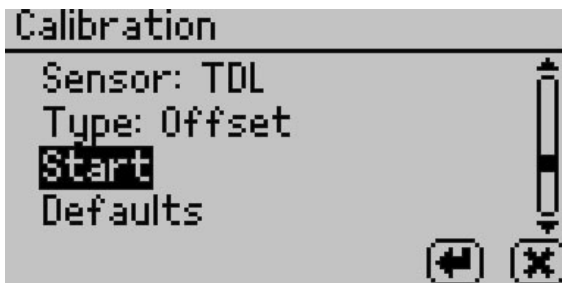

Figure 49 Start calibration

To return to the prior tab, select **CANCEL**.

5. A prompt will appear to insert a fresh standard and seal the chamber (Figure 50).

NOTE: The same verification standard can be used to verify and adjust the linear offset. If using the same verification standard, do not open the sample chamber between verification and offset.

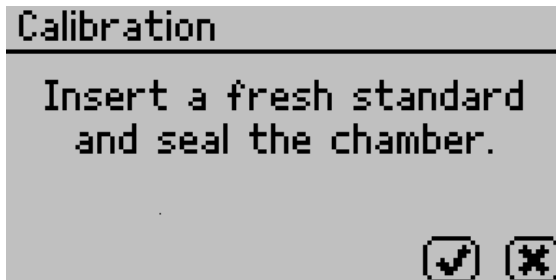

Figure 50 Calibration instruction dialog

6. Empty the whole vial of water activity standard into a sample cup.
METER recommends using the 6.00 NaCl (0.76 a_w). Do not adjust for the offset using steam distilled water.
7. Ensure the rim and outside of the cup are clean.
8. Place the sample cup in the sample chamber.
9. Carefully close the lid and move the lever to the READ position.
10. Select **OK** to begin testing.

NOTE: To interrupt the offset procedure, return the lever to the OPEN position or select **CANCEL** to return to the previous screen.

After the AQUALAB TDL has finished measuring the verification standard, it displays a Change the offset screen (Figure 51).

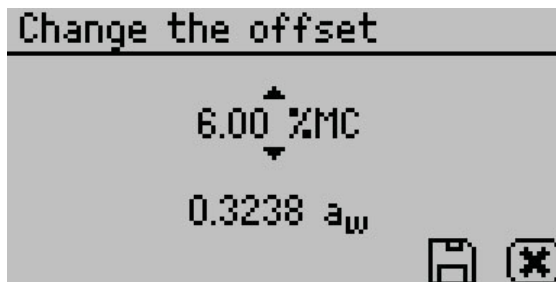

Figure 51 Change the offset screen

11. Use **UP** and **DOWN** to adjust the water activity reading to its proper value for the particular verification standard.
12. Select **SAVE** to store this new value.

To cancel and return to the main menu, select **CANCEL** to make no changes.

13. Restart the verification procedure in [Section 4.1.1](#).

If incorrect verification standard readings persist after cleaning the chamber and adjusting for linear offset, contact [Customer Support](#) for further instructions.

4.1.3 MULTIPOINT CALIBRATION

The AQUALAB TDL is optimized for performance at specific temperatures. If testing is to be conducted at new temperatures, an updated calibration will be needed. If a temperature setting that has not been used previously is chosen, an error message will appear instructing the user that the calibration needs to be updated. This update can be either a linear offset ([Section 4.1.2](#)) or a multipoint update, which requires reading multiple water activity standards.

By default, 0.25, 0.50, 0.76 unsaturated salt solutions, and 1.00 a_w distilled water are needed to proceed with the multipoint calibration.

In firmware version v3.3.0 and newer, the salt standards that are used for multipoint calibrations by navigating to admin settings configuration option. For details, see [page 28](#).

1. Change instrument temperature setting to desired testing temperature.
2. Navigate to the Configuration tab.
3. Select **Calibration** from the Configuration tab ([Figure 52](#)).

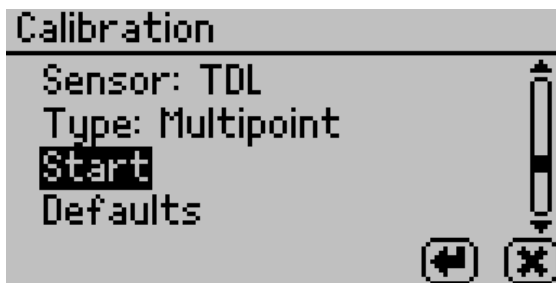

Figure 52 TDL sensor calibration screen

4. Highlight **Type** and select **ENTER** to toggle to **Multipoint**.
5. Select **Start**.

Prompts will instruct to insert a fresh standard and seal the chamber (Figure 53).

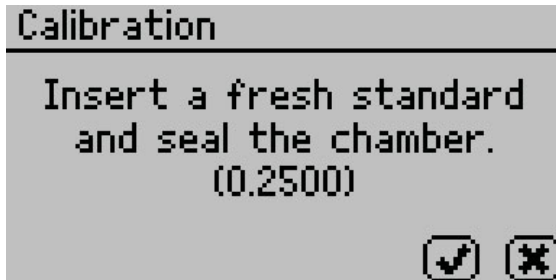

Figure 53 Prompt to insert fresh standard

6. Empty the whole vial of 0.25 a_w standard solution into a sample cup.
7. Ensure the rim and outside of the cup are clean.
8. Place the sample cup in the sample chamber.
9. Carefully close the lid and move the lever to the READ position.
10. Select **OK** to begin testing.
11. After AQUALAB TDL has finished measuring the verification standard, a new screen appears requesting that a 0.50 a_w standard be placed in the chamber.
12. Repeat [steps 6](#) through [10](#) using 0.50, 0.76, and 1.00 a_w standards.

NOTE: To end the multipoint calibration program, select **CANCEL** to return to the previous screen.

When measurements are complete on all four standards, the Verification Complete screen appears showing the testing results for each standard (Figure 54).

Verification Complete			Verification Complete		
Standard	Read	Error	Standard	Read	Error
0.250	0.254	0.004	1.000	0.998	-0.002
0.500	0.492	-0.008			
0.760	0.757	-0.003			

Navigation icons: [Left Arrow] [Checkmark] [X]

Figure 54 Verification Complete screen with results

13. Select **OK** to continue or **CANCEL** to cancel the entire process.

NOTE: Select the audio icon to turn beeping on and off.

14. To make adjustments to the calibration, select **OK**.

Select **CANCEL** to cancel without adjusting the calibration (Figure 55).

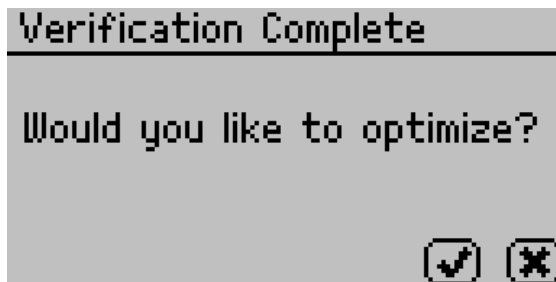

Figure 55 Prompt to adjust calibration

15. To save the new calibration changes, select **SAVE**.

To cancel the multipoint calibration without saving the new changes, select **CANCEL** (Figure 56).

Calibration Complete		
Standard	Read	Error
1.000	0.998	-0.002

Navigation icons: [Left Arrow] [Checkmark] [X]

Figure 56 Calibration Complete screen

Once the multipoint calibration is saved, a confirmation screen will appear (Figure 57).

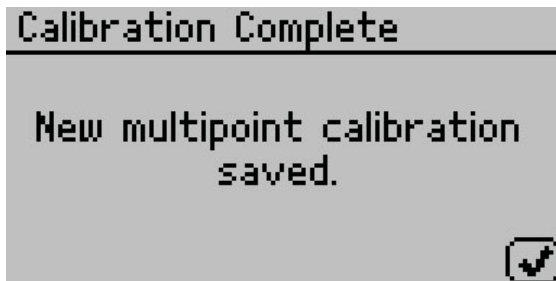

Figure 57 Calibration saved confirmation

16. Select **OK** to continue.
17. If the calibration is canceled at any point, a Calibration Canceled confirmation will appear. Select **OK** to continue (Figure 58).

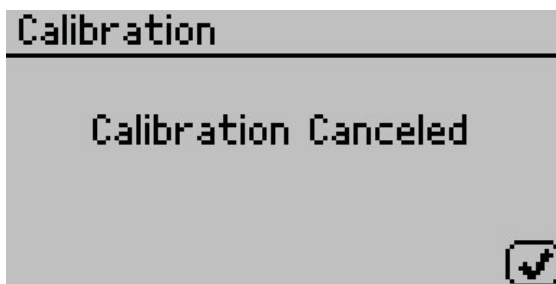

Figure 58 Calibration canceled confirmation

18. Measure a 0.25 or 0.50 a_w verification standard in the Measurement tab.
19. Verify the AQUALAB TDL reads within $\pm 0.005 a_w$ at a given temperature.
20. Measure a 0.76 a_w verification standard.
 - If both verification readings are within $\pm 0.005 a_w$, the instrument is ready to begin testing.
 - If incorrect verification standard readings persist, contact [Customer Support](#).

4.1.4 RESTORE FACTORY DEFAULTS

To restore original calibration settings, do the following:

1. Navigate to the Configuration tab using **MENU**.
2. Select **Calibration**.
3. Select **Defaults** to access the Restore Factory Defaults routine (Figure 59).
Select **CANCEL** to return to the Configuration tab.

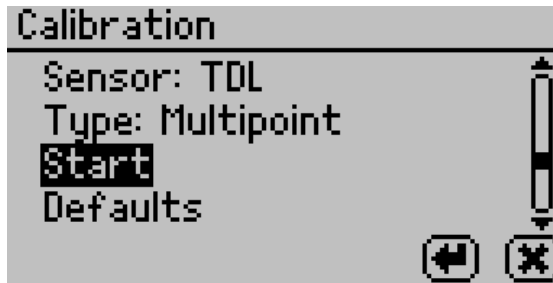

Figure 59 Calibration screen with Defaults selected

A confirmation dialog will appear (Figure 60).

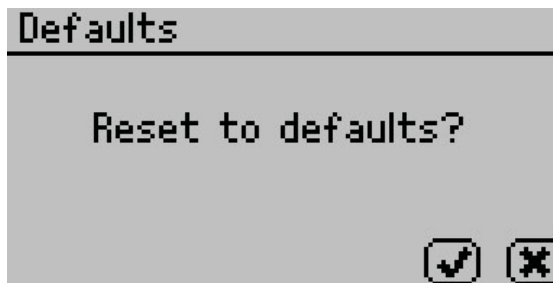

Figure 60 Confirmation dialog to reset defaults

4. Select **OK**.

Select **CANCEL** to return to the Calibration menu.

The instrument will confirm the factory calibration has been restored (Figure 61).

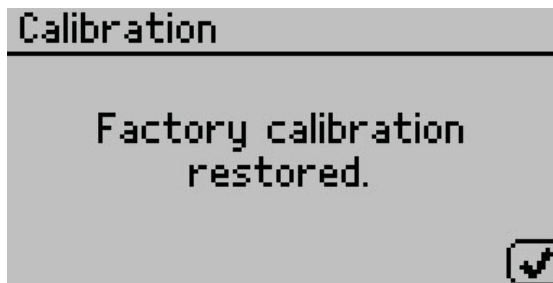

Figure 61 Confirmation that factory calibration was reset

5. Select **OK**.

4.2 CLEANING

Keeping the AQUALAB TDL clean is vital to maintaining the accuracy of the instrument. Dust and sampling debris can contaminate the sampling chamber, so regular cleaning is essential.

To clean the AQUALAB TDL, carefully follow these instructions and refer to the labeled diagram in [Figure 62](#). A video is also available at [AQUALAB TDL certification](http://metergroup.com/en/meter-food/instrument-training/aqualab-tdl-certification) (metergroup.com/en/meter-food/instrument-training/aqualab-tdl-certification).

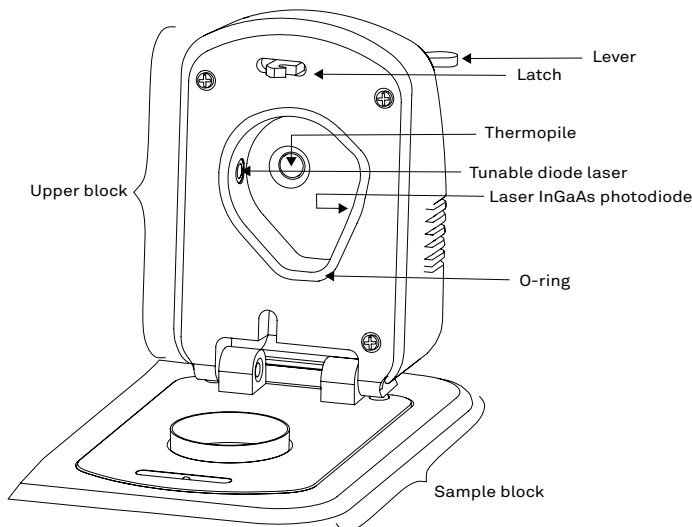

Figure 62 AQUALAB TDL sample chamber diagram

The purpose of the cleaning procedure is to remove grease, dirt, and other soluble substances that can absorb or release water during verification, calibration, or sample testing. For the laser and IR sensor to perform well, they must be clean and free from contaminants.

The instrument should be cleaned if visual inspection indicates the chamber is dirty or as part of the verification process ([Section 4.1](#)).

4.2.1 CLEANING KIT

The AQUALAB comes with an AQUALAB Cleaning Kit that contains enough cleaning supplies to clean the instrument for about 1 year. The following supplies are included:

- Spatula (a thin plastic rod)
- Deionized water for cleaning
- Cleaning Solution
- KIMWIPES® tissues
- Activated charcoal

NOTE: Wash hands with soap and water, and wear clean gloves before starting the cleaning procedure. This prevents oils from contaminating the cleaning materials, the sample chamber, and the sensors.

4.2.2 CLEANING PROCEDURE

The procedure to clean AQUALAB TDL involves washing, rinsing, and drying each area.

NOTE: Isopropyl alcohol can be substituted for the Cleaning Solution.

1. Turn the AQUALAB TDL power OFF.
2. Open the chamber cover to expose the sample chamber and sensors.
3. Clean the sample chamber. The sample chamber consists of all surfaces inside the orange O-ring when the lid is closed.
 - a. Remove any debris that may have collected within or around the sample chamber.
 - b. Wrap a new tissue around the end of the spatula and moisten it with cleaning solution.

NOTE: Do not dip used tissue into the cleaning solution as the cleaning solution will become contaminated.
 - c. Clean upper chamber, O-ring and all surfaces of the sample block within the orange O-ring.

Replace the tissue if it becomes too dirty during this process.
 - d. Clean lower block with a fresh KIMWIPES tissue. Clean the entire block surface.
 - e. Repeat [steps b](#) through [d](#) using a new KIMWIPES tissue moistened with deionized water.
 - f. Repeat [steps b](#) through [d](#) using a new, dry KIMWIPES tissue to remove any moisture remaining from the cleaning.

NOTE: Do not reuse tissues.
4. Clean the tunable diode laser.
 - a. Wrap a new KIMWIPES tissue around the end of the spatula and moisten it with cleaning solution.
 - b. Gently swipe the moistened tissue across the TDL emitter and detector lens once.

A single swipe is usually sufficient to remove contaminants.
 - c. Repeat [steps a](#) and [b](#) using a new KIMWIPES tissue moistened with deionized water.
 - d. Repeat [steps a](#) and [b](#) using a new, dry KIMWIPES tissue to remove any moisture remaining from the cleaning.
 - e. Visually inspect the tunable diode laser for cleanliness. Clean again if necessary.
5. Clean the IR sensor.
 - a. Wrap a new KIMWIPES tissue around the end of the spatula and moisten it with cleaning solution.
 - b. Swipe the moistened tissue across the IR sensor.

A single swipe across the sensor is usually sufficient to remove contaminants.

- c. Repeat [steps a](#) and [b](#) using a new KIMWIPES tissue moistened with deionized water.
 - d. Repeat [steps a](#) and [b](#) using a new, dry KIMWIPES tissue to remove any moisture remaining from the cleaning.
 - e. Visually inspect the IR sensor for cleanliness. Clean again, if necessary.
6. Visually inspect the sample chamber and sensors for contaminants, including moisture. If necessary, repeat the cleaning process using new KIMWIPES tissues.
 7. Let stand for 5 min to ensure the sample chamber is dry.
 8. After cleaning the AQUALAB TDL, check the instrument performance and correct for any linear offset that may have occurred during the cleaning process.
 - a. Run a sample of the activated charcoal pellets from the AQUALAB Cleaning Kit. This cleans the air inside the chamber, helping it come back to a stable sampling environment.
 - b. Verify the linear offset against known verification standards as described in [Section 4.1.2](#).
 - c. If a linear offset has occurred, adjust for linear offset.

If the instrument is still not reading samples correctly, contact [Customer Support](#).

4.3 MAINTENANCE PACKAGES

METER offers maintenance and calibration packages to ensure AQUALAB is functioning to its highest standard ([Table 5](#)).

Table 5 Maintenance package options

Package	Basic Calibration Service
As-found inspection	Available
Replace old/damaged parts	Separate charge per part
Instrument cleaning	Included
Factory calibration	Included
Extended 1-year warranty	Not included
Loaner instrument	Available

Replacement parts can also be ordered from METER. Contact [Customer Support](#).

4.4 REPAIR

METER repairs manufacturer defects and instruments within the 1-year warranty at no charge. Repairs outside of the warranty window are charged based on cost of parts, labor, and shipping. An extra fee may be charged for rush work. Contact [Customer Support](#) for an estimated repair cost.

METER has loaner instruments available for a fee while the AQUALAB TDL is being serviced.

All AQUALAB TDL units returning to METER for servicing must be accompanied with a Return Merchandise Authorization (RMA) number. Prior to shipping the instrument, contact [Customer Support](#) to obtain an RMA number.

1. Place the AQUALAB in a plastic bag to avoid disfiguring marks from the packaging.
2. Do not ship the power cord, serial cable, or any other accessories.
3. Ship the AQUALAB in its original cardboard box with suspension packaging.

If the original packaging is not available, use a box with at least 4 in of packing material (e.g., Styrofoam™ peanuts or bubble wrap) between the instrument and each wall of the box, ensuring the instrument is suspended in the packing material.

4. On the RMA form, please verify the ship to and bill to information, contact name, and problem description.

If anything is incorrect, please contact [Customer Support](#).

5. Tape the box in both directions for added support.
6. Include the RMA number in the attention line on the shipping label.

A Certificate of Calibration will be issued upon completion of the work.

4.5 TROUBLESHOOTING

[Table 6](#) lists common problems and their solutions. If the problem is not listed or these solutions do not solve the issue, contact [Customer Support](#).

Table 6 Troubleshooting the AQUALAB TDL

Problem	Possible Solutions
<p>AQUALAB does not turn on</p>	<p>Ensure the power cord is securely attached to the back of the instrument and plugged into the power outlet.</p> <p>A power surge may have caused a fuse to blow. To change the fuses:</p> <ul style="list-style-type: none"> • Unplug the power cord. • Locate the panel where the power cord plugs in. The fuse box is on the right side of that panel. Press the release tab and pull the fuse-holder out. • Pull the broken fuse out and replace with a 1.25-A, 250-V fuse. <p> CAUTION</p> <p>Do not use any other kind of fuse to avoid risk of damaging the instrument or voiding the warranty.</p> <ul style="list-style-type: none"> • Replace the fuse holder and push it into the fuse well until the release tab snaps in place. • Connect the power cord and turn the instrument on. <p>If the fuse blows again, a failed component may be causing the problem. Contact Customer Support to make arrangements for repairs.</p>

Missing aw calibration! error

Due to the temperature sensitivity of the tunable diode laser measurement technique, the AQUALAB TDL requires calibration at the temperature being measured. This can be done as an optional factory calibration or as an offset or multipoint calibration can be made by the user ([Section 4.1](#)).

Table 6 Troubleshooting the AQUALAB TDL (continued)

Problem	Possible Solutions
<p>Readings are slow or inconsistent</p>	<p>The sample chamber may be dirty. Refer to Section 4.2 for directions on cleaning the sample chamber.</p> <p>The temperature difference between the sample and the block chamber may be too great. Allow the sample to equilibrate to instrument temperature. Refer to Section 2.2.2.</p> <p>Some products absorb or desorb moisture very slowly, causing measurements to take longer than usual, and nothing can be done to speed up the process. Refer to Section 2.2.1.</p>
<p>Water activity readings on verification standards are too high or too low and a linear offset adjustment cannot be made any higher or lower</p>	<p>The IR sensor, which measures sample temperature, may have become contaminated. Refer to Section 4.2 for directions on cleaning.</p> <p>The AQUALAB TDL lenses may be dirty. Refer to Section 4.2 for directions on cleaning.</p>
<p>Remove sample. Sample is too hot! error message</p>	<p>The sample temperature is too high for the instrument to equilibrate within a reasonable amount of time. Ensure samples are at the same temperature as the instrument (Section 2.2.2).</p>
<p>Crystal Failure. See Manual for options. error message</p>	<p>The crystal that runs the firmware is having trouble starting. Cycle the power. If this message continues to appear, the instrument needs to be serviced by METER (Section 4.4).</p>
<p>Verification is not correct</p>	<p>Clean the sample chamber and components. Refer to Section 4.2 for detailed cleaning instructions.</p> <p>If verification is still not correct, verify and adjust for linear offset (Section 4.1.2).</p>
<p>Pressure sensor failure</p>	<p>The pressure sensor used during water activity measurements is not functioning correctly and needs to be replaced. METER needs to service the instrument (Section 4.4).</p>
<p>Firmware is corrupted. See Manual for options. error message</p>	<p>The firmware on the instrument is corrupted and needs to be reloaded. To download new firmware to the AQUALAB TDL models, the instrument must be serviced by METER (Section 4.4).</p>

The model selected may not be correct for the product being tested. Toggle through the available models to find a more appropriate model.

Moisture content displayed is not correct

If the model is correct but not giving correct moisture content values, it may be necessary to offset the model. See [Section 2.6](#) for detailed instructions.

If the model is correct and an offset does not work, it may be necessary to generate a new model for the product or update an existing model. For information about updating or generating a model, contact [Customer Support](#).

Table 6 Troubleshooting the AQUALAB TDL (continued)

Problem	Possible Solutions
Moisture content does not show up on the Measurement tab	Moisture content has not been activated. Toggle to the Configuration tab, select %Moisture, and select the appropriate model.
Message on the Measurement tab displays no moisture content reading	When a moisture content reading is not shown, the water activity or temperature for that reading is beyond the scope of the moisture sorption isotherm. This can happen under the following two conditions: <ul style="list-style-type: none"> • The isotherm equation calculates a moisture content that is less than 0% or greater than 100% with the given water activity. • The control temperature is significantly different than the isotherm temperature. Make sure that the sample water activity and the instrument controlling temperature are within the scope of the selected moisture sorption isotherm model.
Sensors are reading outside of the typical range	If, after cleaning the instrument and following troubleshooting guidelines, there is still a measurement error, navigate to the Diagnostics screen. If the sensor is reading outside of this range, contact Customer Support .

4.6 CUSTOMER SUPPORT

NORTH AMERICA

Customer service representatives are available for questions, problems, or feedback Monday through Friday, 7:00 am to 5:00 pm Pacific time.

Email: support.food@metergroup.com
sales.food@metergroup.com

Phone: +1.509.332.5601

Fax: +1.509.332.5158

Website: metergroup.com

EUROPE

Customer service representatives are available for questions, problems, or feedback Monday through Friday, 8:00 to 17:00 Central European time.

Email: support.europe@metergroup.com
sales.europe@metergroup.com

Phone: +49 89 12 66 52 36

Fax: +49 89 12 66 52 20

Website: metergroup.de

If contacting METER by email, please include the following information:

Name	Email address
Address	Instrument serial number
Phone	Description of the problem

NOTE: For products purchased through a distributor, please contact the distributor directly for assistance.

4.7 TERMS AND CONDITIONS

By using METER instruments and documentation, you agree to abide by the METER Group, Inc. USA Terms and Conditions. Please refer to metergroup.com/terms-conditions for details.

REFERENCE

Labuza, Ted P., K. Acott, S. R. Tatini, R. Y. Lee, J. Flink, and W. McCall (1976). "Water activity determination: A collaborative study of different methods." *Journal of Food Science* 41, no. 4: 910–917.

INDEX

A

accuracy **6, 19**
 admin settings **28–30**
 annual calibration service **39, 50**
 autosave **7, 26, 31–32**

B

beep **23, 32**

C

calibration **7, 25, 39**
 multipoint **43–46**
 restore **46–47**
 Certificate of Calibration **1, 51**
 charcoal **50**
 cleaning **48–51**
 cleaning kit **1, 48–49**
 procedure **49–50**
 compliance **20**
 components **20–32**
 buttons **22, 23**
 display screen **23–33**
 Configuration tab **24–31**
 Data tab **33–34**
 Measurement tab **24**
 power cord **1, 21**
 RS-232 cable **20, 21**
 sample chamber **21–22**
 thermopile **22**
 tunable diode laser **22**
 USB cable **1, 20**
 Configuration tab **24–31**
 contamination **39, 40**
 customer support **53**

D

data

 annotate **8**
 delete **34**
 view **8–9, 33–34**
 Data tab **33–34**
 date **27–28**
 diagnostics **32**

E

email address **53, 54**

F

fax number **53, 54**
 fuse **2, 51**

G

Gibbs free energy **37**

I

installation **2–3**
 isotherm model
 model offset **9–12**
 theory **38–39**

L

linear offset **39, 41–42**
 liquid phase water **35–36**
 loaner instrument **51**

M

maintenance **50**
 matrix effects **37**
 Measurement tab **24**
 microbial growth **34**
 mode
 continuous **26**

custom **26–27**
 ISO **26**
 low-emitting **5, 27**
 print **32**
 single **26**
 moisture content
 theory **38**
 value **7**

O

osmotic effects **37**

P

phone number **53, 54**
 pressure effects **36**

R

read time **3, 4, 19**
 reference **55**
 regional formatting **28**
 relative humidity **5, 20, 35–36**
 repair **50–51**
 RMA number **51**

S

sample composition **4–5**
 coated **5**
 dried **5**
 multicomponent **4**
 sample cup **4, 19**
 sample preparation **3–4**
 sample temperature **5–6**
 sensor **26**
 serial number **32**
 settings
 beeps **32**
 date **27**
 language **28**
 mode **26–28**
 temp eq **25**

temperature **25**
 time **28**
 specifications **19–20**
 compliance **20**
 measurement **19**
 physical **19–20**
 power voltage **20**

T

temp eq **25**
 temperature **19, 20, 25**
 temperature effects **36**
 terms and conditions **54–55**
 theory
 moisture content **38**
 sorption isotherms **38**
 water activity **34–36**
 water potential **37**
 thermometer **20, 35, 36**
 time **28**
 troubleshooting **51–53**

U

user setup **28–31**

V

vapor phase water **35**
 verification **39–43**
 verification standards **1, 39–40, 40**

W

water activity **19, 20, 34–36**
 water potential **37**

METER Group, Inc. USA

2365 NE Hopkins Court Pullman, WA 99163
T: +1.509.332.2756 F: +1.509.332.5158
E: info@metergroup.com W: metergroup.com

METER Group AG

Mettlacher Straße 8, 81379 München
T: +49 89 1266520 F: +49 89 12665220
E: info.europe@metergroup.com W: metergroup.de

