



# METEOROLOGICAL INSTRUMENTS

## INSTRUCTIONS

**ELECTRONIC COMPASS  
W/ SERIAL INTERFACE**

**MODEL 32500**





**SPECIFICATIONS\***

Compass:  
 Resolution: 0.5 degrees  
 Accuracy: ±2 degrees (rms)

Wind Speed Input:  
 Sensor Type: AC Frequency Generator  
 Sensitivity: 50mV p-p at 10Hz  
 Range: 0-2000 Hz

Wind Direction Input:  
 Sensor Type: Potentiometer  
 Range: 0-5000mV = 0 to 355 degrees  
 Excitation: 5000mV (limited to 5 mA)

Voltage Inputs (Auxiliary Sensor Inputs):  
 Resolution: 12-bit  
 VIN1 and VIN2 0-1000mV  
 VIN3 and VIN4 0-5000mV

Voltage Outputs:  
 OUT1 0-5000mV 0-100 m/s wind speed  
 OUT2 0-5000mV 0-360° true wind direction

Serial Output: Full duplex RS-232,  
 Half duplex RS-485 (2 mS turnaround)  
 1200, 4800, 9600, 19.2K, & 38.4K baud  
 8 data, 1 stop, no parity

Operating Temp: -50°C to 50°C

Power: 11 to 30 VDC, 40 mA

Mounting: 1 inch IPS (1.34 inch actual diameter)

Size: 9.50" (24.1cm) H  
 2.83" (7.2cm) W  
 3.82" (9.7cm) D

\*Specifications subject to change

**1.0 INTRODUCTION**

The Model 32500 ELECTRONIC COMPASS measures magnetic heading, wind speed and direction signals from YOUNG sensors, and signals from four general purpose voltage inputs. Wind direction input may be combined with the direction input to obtain true direction. Voltage inputs may be used with YOUNG temperature and humidity, barometric pressure, precipitation, or other sensors. These input signals are converted into scaled values and placed on a serial string, which is output at up to 15 hertz.

Measurements are available in several formats in either full duplex RS-232 or half-duplex RS-485 signals. Both continuous and polled serial outputs are available. When polled, up to 16 units can be networked together. For marine applications the 32500 produces standard NMEA serial output sentences. Calibrated voltage outputs for wind speed and direction are also provided when the 32500 is connected to a YOUNG wind sensor.

**2.0 INSTALLATION**

The 32500 is supplied in a weather-resistant enclosure with a mounting adapter that fits 1 inch IPS pipe (1.34 inch nominal diameter). When used with the YOUNG Wind Monitor or 86xxx series Ultrasonic Anemometer the mounting adapter engages with the sensor orientation notch. Refer to the WIRING DIAGRAM for electrical connection details and jumper settings.

It is important to install the 32500 so it remains level during operation. This becomes increasingly important when used at northern and southern latitudes far from the equator since progressively more of the earth's magnetic flux becomes vertical. By keeping the 32500 level at these latitudes, the measurements will be free of the vertical flux influence and remain accurate.

If possible, avoid installing the compass near magnetic devices or machinery. After installation, the compass must be calibrated to correct for local magnetic conditions. If the compass is moved or its local environment changes significantly (machinery moved), the compass should be calibrated again.

**3.0 OPERATION**

Operation begins automatically when power is applied. Jumper settings configure the 32500 for common output formats as well as output type. Input signal connections are dependent upon the serial output format and input type selected.

**3.1 JUMPER CONFIGURATIONS**

W1 JUMPERS A, B, and C, determine serial output format. Jumper configurations and associated output format are listed below: 1 signifies that jumper is installed, 0 signifies that jumper is omitted. See the SERIAL FORMAT DIAGRAM for more details.

A	B	C	SERIAL OUTPUT FORMAT (Baud Rate, Output Rate)
0	0	0	ASCII Ouput (9600, 2Hz)
0	0	1	Polled ASCII (9600)
0	1	0	NMEA1 (4800, 2 Hz)
0	1	1	NMEA2 (4800, 2 Hz)
1	0	0	RMYT (9600, 15 Hz)
1	0	1	PRECIP (9600, 15 Hz)
1	1	0	PRECIP POLLED (9600)
1	1	1	SOFTWARE Mode (set by user, see section 4.2)

ASCII and POLLED ASCII are general purpose outputs that may be used with the YOUNG 26800 or devices that can communicate serially.

NMEA1 and NMEA2 outputs are generally for marine applications. NMEA1 produces a "\$WIMVW" string containing speed and direction values. NMEA2 produces both a "\$WIMVW" and "\$WIXDR" string, the latter containing temperature, humidity and pressure values.

RMYT is a binary format for use with the YOUNG Wind Tracker.

PRECIP and PRECIP POLLED configure VIN4 as a special input to count tipping bucket precipitation gauge switch closures. (Requires a 10K ohm resistor from VIN4 to EXC terminal.)

SOFTWARE mode allows output format and other parameters to be set using serial commands. Please see section 4.0 SERIAL COMMUNICATION and the SERIAL FORMAT DIAGRAM for more information.

W2 & W3 JUMPERS determine output connection type. Only one connection type may be used at a time. Please refer to the WIRING DIAGRAM for jumper location and connection details.

JUMPERS	OUTPUT TYPE
VOUT	Calibrated output for wind speed and direction OUT1 0-5000mV = 0-100 m/s Wind Speed OUT2 0-5000mV = 0-360 degrees Wind Direction
232	RS-232 full duplex serial
485	RS-485 half duplex serial

### 3.2 COMPASS CALIBRATION

When the 32500 is operated for the first time, its internal compass must be calibrated for local conditions. To calibrate the compass, please follow the steps outlined below.

1. Remove cover from compass. Press and hold CALIBRATE button for 5 seconds. The CALIBRATE indicator will begin to blink. Refer to WIRING DIAGRAM to locate CALIBRATE button.
2. Slowly rotate vehicle on which compass is mounted. Steer vehicle in a tight circle and make TWO complete revolutions. Each revolution should take at least one minute. THE COMPASS MUST REMAIN LEVEL DURING CALIBRATION.
3. After two complete revolutions, press and hold CALIBRATE button until indicator stops blinking. Calibration is now complete. Calibration parameters are retained when power is removed.
4. Replace cover. Use this procedure to recalibrate compass at any time.

Serial communication command may also be sent to start and stop the compass calibration. Please see section 4.2 SERIAL COMMANDS for details

### 3.3 SIGNAL INPUTS

The 32500 has two special wind speed and direction inputs for YOUNG wind sensors and four voltage input channels for connection to other meteorological instruments like temperature, humidity, barometric pressure, precipitation, or other sensors. Two of the voltage input channels may also be configured as alternative wind speed and wind direction inputs for sensors like the Young 86xxx family. For best performance, sensors should be installed within 3m (10ft.) of the 32500.

Measurements from the voltage input channels are converted to numerical values (0-4000) when ASCII, POLLED ASCII, PRECIP, or PRECIP POLLED are used. VIN1 and VIN2 full scale input is 1000mV DC (serial value = input mV x 4); VIN3 and VIN4 full scale input is 5000mV (serial value = input mV x 0.8). Note that VIN4 is used to count tipping bucket precipitation sensor tips when PRECIP or PRECIP POLLED are used.

When NMEA1 or NMEA2 are used the measurements from the voltage input channels are converted to following:

- VIN1 (0 to 1000mV must = -50 to +50 C), Temperature (C);
- VIN2 (0 to 1000mV must = 0 to 100%), Humidity (%);
- VIN3, Barometric Pressure (hPa);
- VIN4, not used. [Wind speed, (Knots)]

Please refer to SERIAL FORMAT DIAGRAM and WIRING DIAGRAM in the back of this manual for additional details.

### 4.0 SERIAL COMMUNICATION

The 32500 uses either full-duplex RS-232 or half-duplex RS-485 signals for serial communication. RS-232 is the most simple and operates up distances of 30m (100ft). The RS-485 option is preferred in electrically noisy environments, in applications where multiple units must be networked, or in NMEA marine applications where RS-485 signals are required.

The full duplex RS-232 connection may transmit and receive serial data at the same time.

The RS-485 connection is half-duplex meaning the unit cannot transmit and receive at the same time. The 32500 internally manages the switch between modes.

Many applications require the 32500 to transmit only. However, RS-485 applications that require polling the 32500 or sending commands to it require that the externally connected serial devices must be capable of managing its own half-duplex switching from transmit to receive.

At low baud rates with proper cable installation and connections, transmission distances up to 7km (4mi) are possible using RS-485.

Baud rates of 1200, 4800, 9600, 19.2K, and 38.4K baud are available. Most jumper-selected output formats force the baud rate to a predetermined value. All serial signals use 1 start, 8 data, and 1 stop bit. Any externally connected serial device must be set to the same baud rate as the 32500.

### 4.1 POLLING

When the serial output format is ASCII POLLED or PRECIP POLLED (See the SERIAL FORMAT DIAGRAM), the 32500 sends data only when it receives a serial polling command: "Mc!" where 'c' is the unique address of the unit. The default address is 'A' but any alpha or numeric character may be used (section 4.2 SERIAL COMMANDS).

### 4.2 SERIAL COMMANDS

Serial commands set operating parameters and report settings. Jumper W1 must be configured for SOFTWARE mode for serial command settings to be retained, otherwise default settings based on jumper configuration will take effect at next power up.

Commands may be sent using a PC and simple communications programs such as HyperTerm or any other properly configured serial device. All commands that begin with CMD must end with a carriage return (ASCII 13).

Commands may be sent at any time but it may be more convenient to pause the Serial interface output. This is especially necessary with half-duplex RS-485 communication.

Please refer to the table on the next page for commands and definitions.

### 5.0 MAINTENANCE

The 32500 requires no maintenance in normal use. Periodic inspection is recommended to verify correct operation.

### 6.0 WARRANTY

This product is warranted to be free of defects in materials and construction for a period of 12 months from date of initial purchase. Liability is limited to repair or replacement of defective item. A copy of the warranty policy may be obtained from R. M. Young Company.

### 7.0 CE COMPLIANCE

This product complies with European CE requirements for the EMC Directive. Please note that shielded cable must be used.

**SERIAL COMMANDS TABLE**

Command	Description	Notes:
<b>CMD100</b>	OPERATE	Operate Mode
<b>CMD110</b>	PAUSE	Pause
<b>CMD200 n</b>	DAMPING (0=NONE, 1=FAST, 2=SLOW)	Determines the amount of averaging applied to the compass measurement
<b>CMD210 n</b>	FORMAT: 0 ASCII 1 ASCII POLLED 2 NMEA (KTS, DIR) 3 NMEA (KTS, DIR, TEMP, RH, BARO) 4 RMYT 5 PRECIP 6 PRECIP POLLED 7 ASCII 2 9 DIAGNOSTIC	Determines serial output format. See section 3.1 for more detailed information. PRECIP formats substitute tipping bucket precipitation counts for the VIN4 voltage measurement. ASCII 2 omits VIN measurement values from the output string
<b>CMD220 n</b>	OUTPUT RATE (0=15Hz, 1=0.1Hz, 2=2Hz)	The rate at which serial data strings are sent.
<b>CMD230 c</b>	POLL CHARACTER (0-9, A-Z)	Sets the unique, single alpha or numeric character polling address.
<b>CMD240 nn</b>	BAUD RATE: 12 = 1200, 48 = 4800, 96 = 9600, 192 = 19200, 384 = 38400	Selects one of several preset baud rates. If you change baud rate while connected, your external device must also be changed in order to continue communicating with the 32500
<b>CMD250 n</b>	INPUT TYPE (1 = PULSE/POT, 2 = VIN3/VIN4)	Determines the type of wind speed and wind direction signal to use. Type 1 is for standard WS pulse input wind speed and WD potentiometer wind direction input. Type 2 is for VIN3 (wind speed) and VIN4 (wind direction). With Type 2 voltage inputs, 0 to 5000mV = 0 to 100 m/s wind speed and 0 to 540 degrees wind direction. These alternative inputs allow connection to devices like the Young 86xxx family of 2D Sonic Anemometer
<b>CMD260 nnnn</b>	BARO RANGE LOW (mB)	Min range of connected Barometer (0.0VDC). Default is 0500 mB.
<b>CMD270 nnnn</b>	BARO RANGE HIGH (mB)	Max range of connected Barometer (5.0VDC). Default is 1100 mB
<b>CMD280 nnn</b>	PROPELLER PITCH (mm/rev)	Sets sensor cup wheel/propeller pitch 03002: 750 mm/rev 04101/4106/05103/05106: 294 mm/rev (default) 05108: 500 mm/rev 05305: 307 mm/rev
<b>CMD900</b>	REPORT PARAMETER SETTINGS	Returns list of current settings in unit
<b>CMD910</b>	START COMPASS CALIBRATION	Same function as the CALIBRATE button. Section 3.1 COMPASS CALIBRATION has details regarding the procedure.
<b>CMD920</b>	STOP COMPASS CALIBRATION	
<b>X</b>	Alternative command to enter OPERATE mode	Operate Mode
<b>3xESC</b>	Alternative command to PAUSE	Pause
<b>3xCNTL-S</b>	Alternative command to START calibration	Start
<b>3xCNTL-X</b>	Alternative command to STOP calibration	Stop



# SERIAL OUTPUT FORMATS

MODEL 32500

ASCII, POLLED ASCII, PRECIP, or PRECIP POLLED

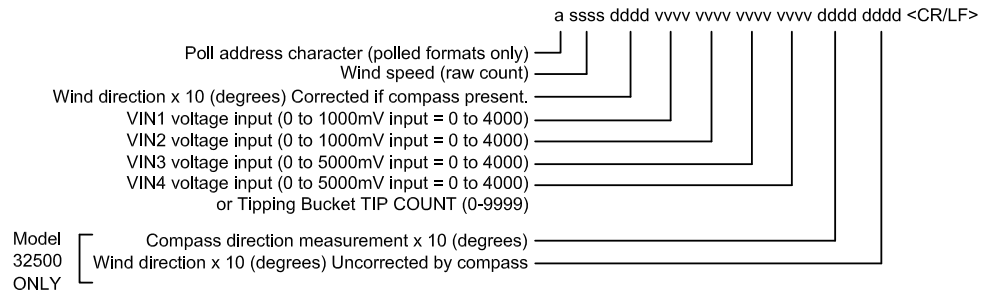

WIND SENSOR	M/S	MPH	KNOTS	KM/HR
03002 *	M=0.3752 O=0.2	M=0.8390 O=0.4	M=0.7285 O=0.4	M=1.3505 O=0.7
04101	0.04903	0.1097	0.09526	0.1765
04106	0.04903	0.1097	0.09526	0.1765
05103	0.04903	0.1097	0.09526	0.1765
05106	0.04903	0.1097	0.09526	0.1765
05108	0.0834	0.1864	0.1620	0.3001
05305	0.05123	0.1146	0.09956	0.1844

The adjacent chart shows multipliers to convert raw pulse count values to standard wind speed units.

Example:  
Sensor = 05103 Wind Monitor  
Raw pulse count in serial string = 323  
MPH Multiplier = 0.1097  
Wind Speed = 323 x 0.1097 = 35.4 MPH

\* Model 03002 is a cup-wheel type sensor therefore wind speed calculation must use multiplier (M) and offset (O).

RMYT serial output for YOUNG Wind Tracker  
Six bytes in binary format.

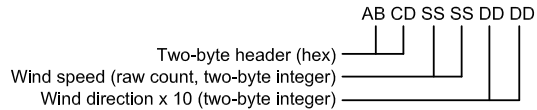

NMEA 1 sentence sends wind speed in KNOTS and wind direction in degrees. Model 32500 designates wind direction as TRUE due to compass correction. Model 32400 designates direction as RELATIVE.

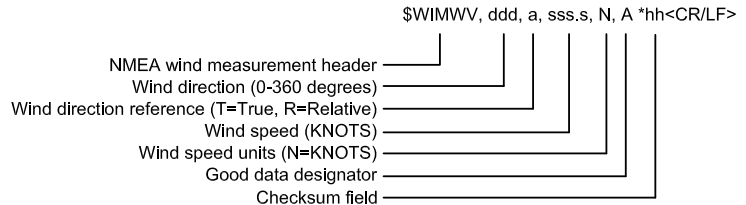

NMEA 2 serial output alternates between the NMEA 1 wind sentence and the following transducer sentence which includes measurements for temperature, relative humidity, and barometric pressure.

Note:  
For correct NMEA 2 serial output string, sensors MUST be connected as follows:

- VIN1 = Temp
- VIN2 = Humidity
- VIN3 = Barometer
- VIN4 = N/A

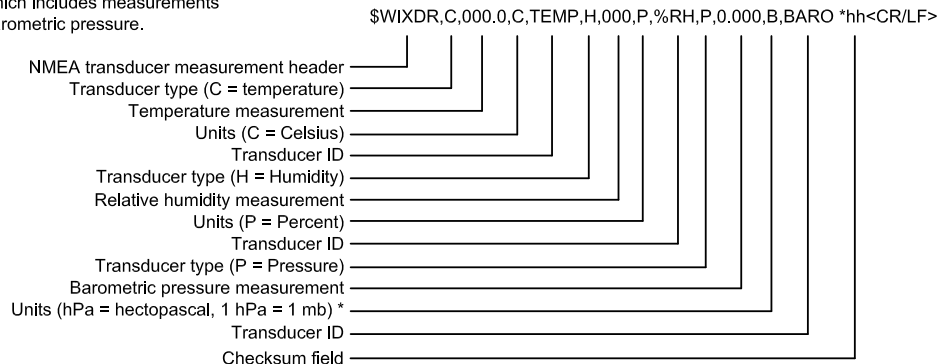



# WIRING DIAGRAM

MODEL 32500 JUMPER CONFIGURATIONS & POWER

SERIAL FORMAT	A	B	C	JUMPER W1
ASCII	<input type="checkbox"/>	<input type="checkbox"/>	<input type="checkbox"/>	
ASCII POLLED	<input type="checkbox"/>	<input type="checkbox"/>	<input type="checkbox"/>	
NMEA 1	<input type="checkbox"/>	<input type="checkbox"/>	<input type="checkbox"/>	
NMEA 2	<input type="checkbox"/>	<input type="checkbox"/>	<input type="checkbox"/>	
RMYT	<input type="checkbox"/>	<input type="checkbox"/>	<input type="checkbox"/>	
PRECIP	<input type="checkbox"/>	<input type="checkbox"/>	<input type="checkbox"/>	
PRECIP POLLED	<input type="checkbox"/>	<input type="checkbox"/>	<input type="checkbox"/>	
SOFTWARE	<input type="checkbox"/>	<input type="checkbox"/>	<input type="checkbox"/>	

OUTPUT TYPE SUMMARY	
OUTPUT	W2 W3
VOLTAGE 0-5000 mV	<input type="checkbox"/> <input type="checkbox"/> <input type="checkbox"/> <input type="checkbox"/> VOUT <input type="checkbox"/> <input type="checkbox"/> <input type="checkbox"/> <input type="checkbox"/>
SERIAL RS-232	<input type="checkbox"/> <input type="checkbox"/> <input type="checkbox"/> <input type="checkbox"/> 232 <input type="checkbox"/> <input type="checkbox"/> <input type="checkbox"/> <input type="checkbox"/>
SERIAL RS-485	<input type="checkbox"/> <input type="checkbox"/> <input type="checkbox"/> <input type="checkbox"/> 485 <input type="checkbox"/> <input type="checkbox"/> <input type="checkbox"/> <input type="checkbox"/>

OUTPUT TERMINAL FUNCTIONS			
SELECTED OUTPUT	OUT 1	OUT 2	REF
RS485	(B)	(A)	REFERENCE
RS232	RECEIVE	TRANSMIT	REFERENCE
VOLTAGE 0-5000 mV	WIND SPEED 0-100 m/s	WIND DIRECTION 0-360°	REFERENCE

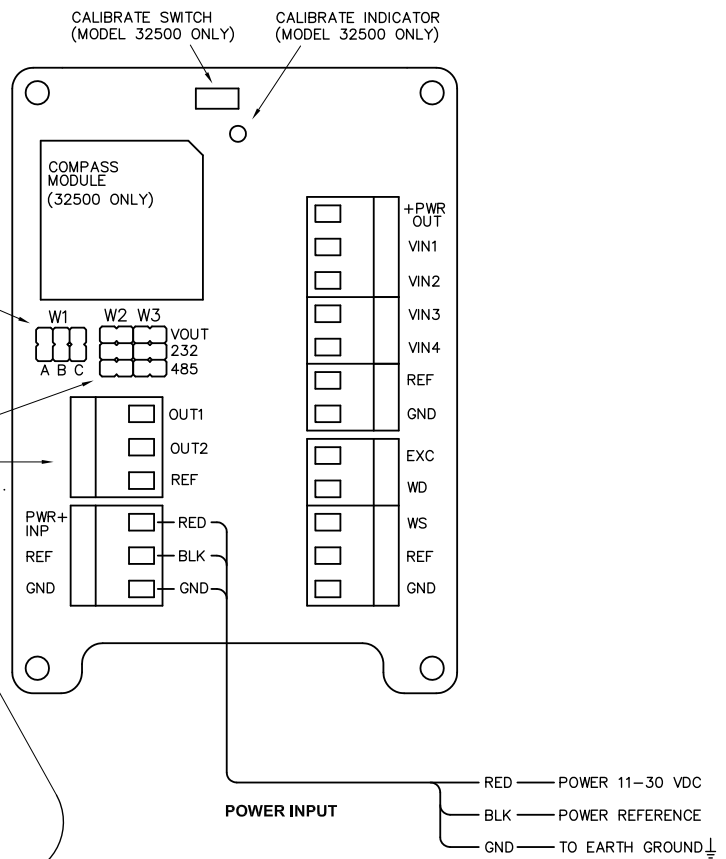



# SERIAL WIRING CONNECTION

MODEL 32500

## RS-232 SERIAL OUTPUT

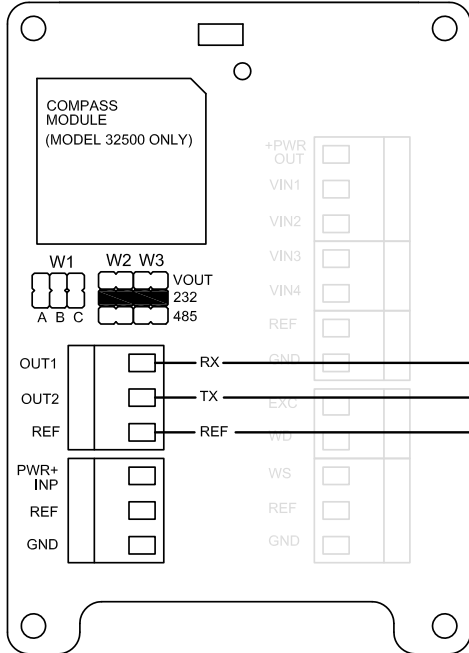

Typical RS-232 connection to PC or other device. 32500 jumpers set for RS-232 ASCII output.

If used with PC HyperTerm communications program, set Flow Control to None.

DB-9F CONNECTOR

## RS-485 SERIAL OUTPUT

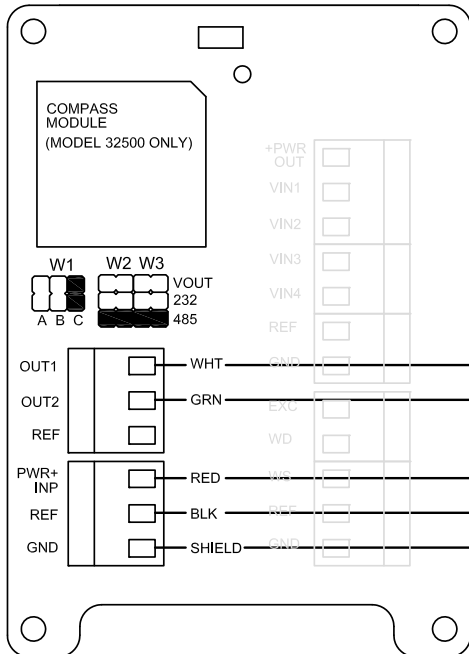

Polled ASCII RS-485 half-duplex serial connection to YOUNG 26800. Note jumper configuration on 32500

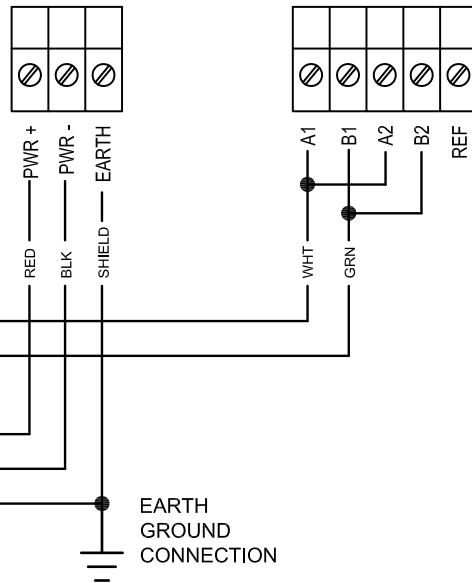



# WIRING DIAGRAM

Output to 06201 Wind Tracker

## OUTPUT TO 06201 WIND TRACKER

RMYT output (9600 baud)

Note jumpers at W1, W2, and W3.

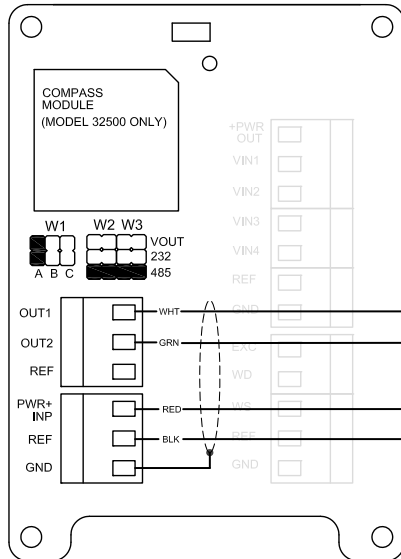

Switch UP to provide power via EXC terminal.

Set input to 09 for RMYT encoding (See Wind Tracker manual)

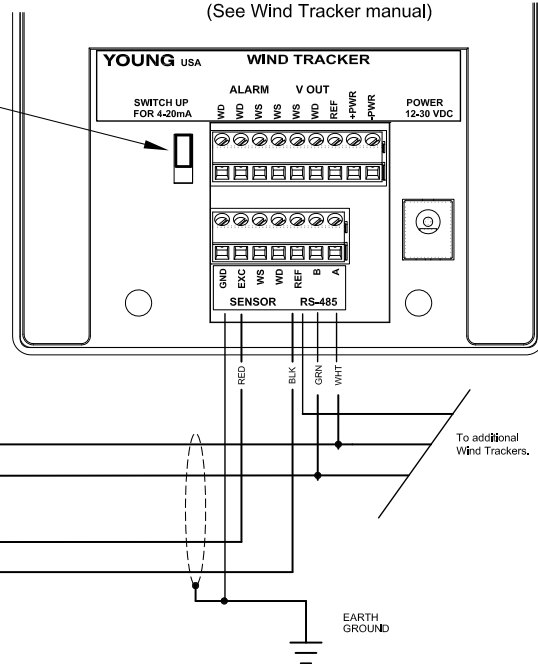

To additional Wind Trackers.





# WIRING DIAGRAM

TYPICAL APPLICATION WIRING

05103 WIND MONITOR  
05305 WIND MONITOR-AQ

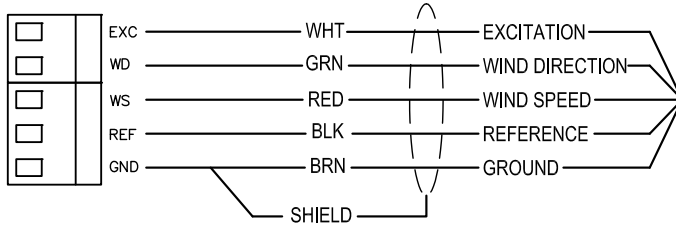
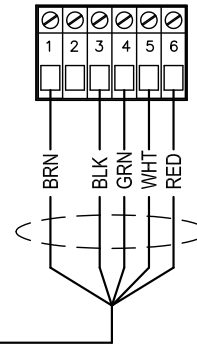
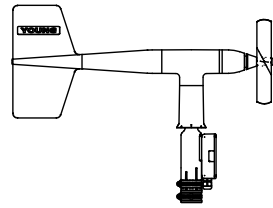

EXCITATION  
WIND DIRECTION  
WIND SPEED  
REFERENCE  
GROUND

MAXIMUM RECOMMENDED  
SENSOR CABLE LENGTH  
3M (10 Ft)

05106 WIND MONITOR-MA  
05108 WIND MONITOR-HD

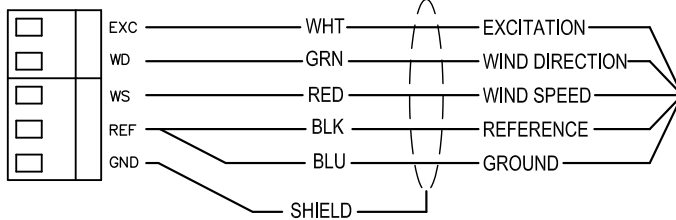
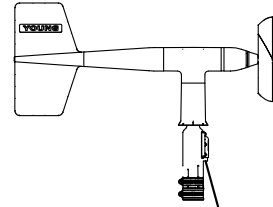

EXCITATION  
WIND DIRECTION  
WIND SPEED  
REFERENCE  
GROUND

52202 TIPPING BUCKET  
(VIN4)

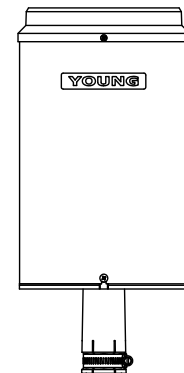
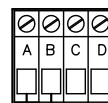
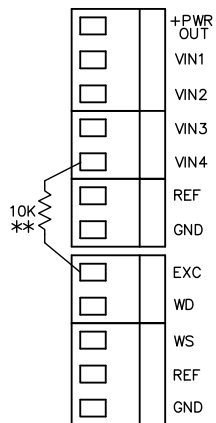

REED SWITCH INPUT  
REFERENCE

\*\* With VIN4 used for Tipping Bucket precipitation switch input, connect 10K ohm resistor between VIN4 and EXC.



# WIRING DIAGRAM

NMEA2 TYPICAL WIRING

**WHEN USING NMEA2 FORMAT  
SENSORS MUST BE CONNECTED AS SHOWN  
FOR PROPER DATA REPORTING**

**41382VC/F TEMPERATURE / RH SENSOR  
WITH VOLTAGE OUTPUT  
(VIN1 & VIN2)**

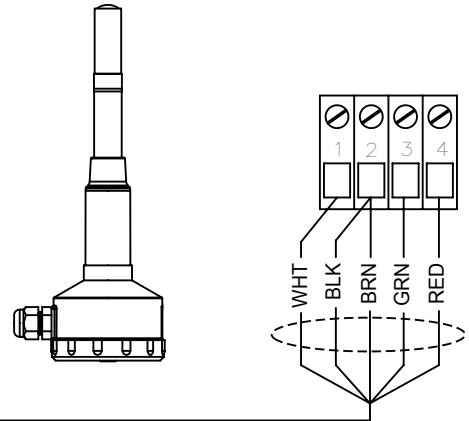
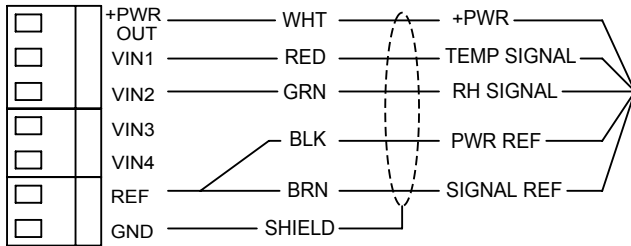

**61402V BAROMETER  
WITH VOLTAGE OUTPUT  
(VIN3)**

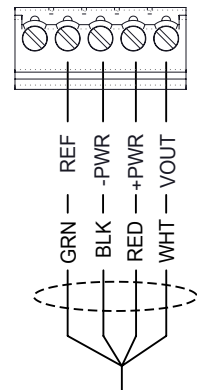
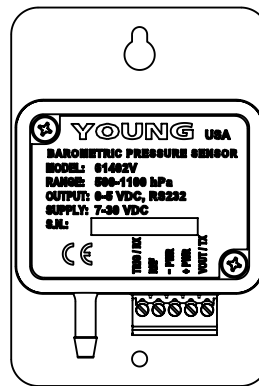
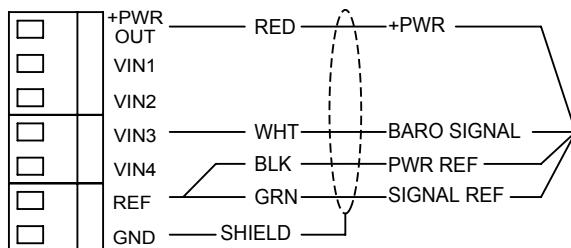



**WIRING CONNECTION**

MODEL 32500 with 86000/86106 2D Sonic Anemometer

INPUT FROM SONIC ANEMOMETER

**86000/86106 SENSOR SETTINGS**

Output Mode: **VOUT**  
WD Output Scale: **0-540**  
Wind Format: **Polar**  
Analog Output Error Code: **High**

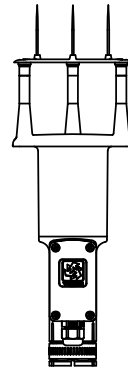

Model 86000 / 86106  
Ultrasonic Anemometer

**NOTES**

32500 connected to 86000 2D Sonic Anemometer with INPUT TYPE = 2 (WS/WD from VIN3 / VIN4). Use the "CMD250 2" to configure this mode.

Keep connection length between 32500 and 86000 short (less than 1m).

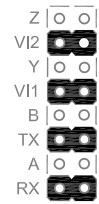

Output Jumper  
J1 Configuration

