

USER MANUAL

# GAS-1031

Carbon Dioxide Analyzer

Version 3.0



POWERED BY ACOEM

[metone.com](http://metone.com)



POWERED BY ACOEM

Met One Instruments is now part of the Acoem Group. The Met One range of gas analyzers was originally developed by Acoem under the brand name Serinus®.

For the purposes of expediting the availability of Met One gas analyzers to Met One customers around the world; Met One Instruments have chosen to use the original Serinus® operating manual.

Although the name of the Met One instrument is different, the analyzer itself has remained unchanged and meets the strictest quality and performance requirements expected of Met One equipment. All the information presented in this manual is current, including analyzer specifications and operating principles.

Met One will update this manual to reflect the new branding convention in due course.

# Table of Contents

Table of Contents.....	3
Manufacturer’s Statement .....	10
Notice .....	10
Safety Information .....	11
Warranty.....	13
Service & Repairs .....	14
Product Compliance and Approvals.....	15
Claims for Damaged Shipments and Shipping Discrepancies .....	16
Manual Revision History .....	17
<b>1. Introduction.....</b>	<b>19</b>
1.1 Description .....	19
1.2 Specifications .....	19
1.2.1 Measurement .....	19
1.2.2 Precision/Accuracy .....	19
1.2.3 Calibration .....	19
1.2.4 Power .....	20
1.2.5 Operating Conditions.....	20
1.2.6 Communications.....	20
1.2.7 Physical Dimensions.....	21
1.2.8 Certifications.....	21
1.3 Nomenclature .....	21
1.4 Background/Theory.....	22
1.4.1 Measurement Theory .....	22
1.4.2 Kalman Filter Theory.....	23
1.5 Instrument Description .....	25
1.5.1 Calibration Valve Manifold .....	25
1.5.2 Sample Filter Holder .....	25
1.5.3 Sample Dryer Assembly .....	25
1.5.4 Measurement Cell .....	26
1.5.5 Pressure Sensor PCA .....	27
1.5.6 Pneumatic Tubing .....	27
1.5.7 Main Controller PCA .....	28
1.5.8 Power Supply .....	28
1.5.9 On/Off Switch .....	28
1.5.10 Communications.....	28
<b>2. Installation.....</b>	<b>31</b>
2.1 Initial Check.....	31
2.2 Installation Notes .....	32
2.3 Instrument Set-Up.....	33
2.3.1 Pneumatic Connections .....	33
2.3.2 Power Connections.....	35
2.3.3 Communications Connections .....	35
2.3.4 Instrument Set-Up .....	36
2.4 Transporting/Storage .....	38

<b>3.</b>	<b>Operation.....</b>	<b>41</b>
3.1	Warm-Up .....	41
3.2	Measurement .....	41
3.3	General Operation Information .....	42
3.3.1	Keypad & Display.....	42
3.3.2	Home Screen .....	44
3.4	Menus & Screens .....	45
3.4.1	Quick Menu .....	45
3.4.2	Main Menu.....	46
3.4.3	Analyser State Menu .....	46
3.4.4	Status Menu .....	47
3.4.5	Temperature Menu .....	48
3.4.6	Pressure & Flow Menu .....	48
3.4.7	Voltage Menu.....	49
3.4.8	General Settings Menu.....	49
3.4.9	Measurement Settings Menu.....	50
3.4.10	Calibration Menu .....	51
3.4.11	Pressure Calibration Menu.....	52
3.4.12	Flow Calibration Menu (Option).....	53
3.4.13	Service Menu.....	54
3.4.14	Diagnostics Menu.....	54
3.4.15	Digital Pots Menu .....	55
3.4.16	Internal Pump Menu (Option) .....	56
3.4.17	Valve Menu .....	56
3.4.18	Tests Menu.....	57
3.4.19	Digital Input Test Menu.....	57
3.4.20	Digital Output Test Menu.....	58
3.4.21	Calculation Factors Menu.....	58
3.4.22	Communications Menu .....	59
3.4.23	Data Logging Menu .....	59
3.4.24	Serial Communication Menu.....	60
3.4.25	Analog Input Menu .....	60
3.4.26	Analog Output Menu.....	61
3.4.27	Digital Input Menu .....	62
3.4.28	Digital Output Menu .....	63
3.4.29	Network Menu (Option).....	64
3.4.30	Bluetooth Menu .....	65
3.4.31	Trend Display Menu .....	65
3.4.32	Chart .....	65
3.4.33	Advanced Menu .....	67
3.4.34	Hardware Menu .....	68
3.4.35	Parameter Display Menu.....	69
<b>4.</b>	<b>Communications.....</b>	<b>71</b>
4.1	RS232 Communication.....	71
4.2	USB Communication .....	72
4.3	TCP/IP Network Communication (optional) .....	73
4.3.1	Reading Network Port Setup .....	74
4.3.2	Setting Network Port Setup .....	74
4.3.3	Port Forwarding on Remote Modem/Router Setup.....	75
4.3.4	Airodis Setup to Communicate with Serinus.....	76

4.4	Analog and Digital Communication .....	77
4.4.1	Analog Outputs .....	77
4.4.2	Analog Inputs .....	78
4.4.3	Digital Status Inputs .....	78
4.4.4	Digital Status Outputs .....	78
4.5	Logging Data .....	79
4.5.1	Configure Instrument Internal Logging .....	79
4.6	Using Airodis Software to Download Data .....	80
4.6.1	Connecting the Instrument to Your PC .....	80
4.6.2	Installing Airodis .....	83
4.6.3	Configuring Airodis .....	83
4.7	Serinus Remote App/Bluetooth .....	89
4.7.1	Installation .....	89
4.7.2	Connecting to the Instrument .....	90
4.7.3	Instrument Control .....	91
4.7.4	Real-Time Plot .....	92
4.7.5	Download .....	94
4.7.6	Get Parameters .....	94
4.7.7	Preferences .....	95
<b>5.</b>	<b>Calibration .....</b>	<b>97</b>
5.1	Overview .....	97
5.2	Pressure Calibration .....	99
5.2.1	Full Pressure Calibration .....	99
5.2.2	Ambient Point Pressure Calibration .....	100
5.3	Pressure Calibration (Internal Pump Option Only) .....	100
5.4	Manual Background .....	101
5.5	Zero Calibration .....	102
5.5.1	Calibration Port .....	102
5.5.2	Sample Port .....	103
5.5.3	Background Air Port .....	103
5.6	Span Calibration .....	103
5.6.1	Calibration Port .....	104
5.6.2	Sample Port .....	104
5.6.3	Manual Instrument Gain and Offset Adjustments .....	104
5.7	Precision Check .....	105
5.8	Multipoint Precision Check .....	105
5.9	Flow Calibration (Internal Pump Option Only) .....	107
5.10	High Pressure Zero/Span Valve (Option) .....	108
5.10.1	Single Pressurised Calibration Option .....	109
5.10.2	Dual Pressurised Calibration Option .....	110
<b>6.</b>	<b>Service .....</b>	<b>113</b>
6.1	Additional Safety Requirements for Service Personnel .....	113
6.2	Maintenance Tools .....	113
6.3	Maintenance Schedule .....	115
6.4	Maintenance Procedures .....	115
6.4.1	Particulate Filter Replacement .....	115
6.4.2	Clean Fan Filter .....	116
6.4.3	Leak Check .....	116

6.4.4	Sintered Filter/Orifice Replacement .....	119
6.4.5	Trim Pot Tuning Procedure .....	120
6.4.6	Clean Pneumatics .....	120
6.4.7	Pressure Sensor Check .....	121
6.5	Bootloader .....	122
6.5.1	Display Help Screen .....	122
6.5.2	Communications Port Test .....	122
6.5.3	Updating Firmware .....	123
6.5.4	Erase All Settings .....	123
6.5.5	Start Analyser .....	123
<b>7.</b>	<b>Troubleshooting.....</b>	<b>125</b>
7.1	Flow Fault .....	128
7.2	Noisy/Unstable Readings .....	129
7.3	Cell Temperature Failure .....	130
7.4	Mirror Temperature Failure.....	131
7.5	USB Memory Stick Failure.....	132
7.6	Ecotech Service Support Files .....	133
<b>8.</b>	<b>Optional Extras.....</b>	<b>135</b>
8.1	Dual Sample Filter (PN: E020100) .....	135
8.2	Network Port (PN: E020101).....	135
8.2.1	Hardware Setup .....	136
8.3	Rack Mount Kit (PN: E020116).....	136
8.4	Internal Pump (PN: E020107) .....	140
8.4.1	Hardware Setup .....	140
8.4.2	Internal Pump Additional Components.....	140
8.4.3	Internal Pump Removed Components .....	141
8.4.4	Pressure Calibration Internal Pump Option .....	141
8.4.5	Flow Calibration .....	141
8.4.6	Internal Pump Leak Check.....	141
8.4.7	Pump Control .....	141
8.5	Metric Fittings Kit (PN: E020122).....	142
8.6	High Pressure Zero/Span Valves .....	142
<b>9.</b>	<b>Parts List and Schematics.....</b>	<b>143</b>
9.1	Serinus Accessories Kit.....	143
9.2	Maintenance Kit.....	143
9.3	Consumables .....	144
9.4	Instrument Parts List.....	144
9.5	Plumbing Schematic – (PN: D020023) .....	147
9.6	Block Wiring Schematic – (PN: D020110) .....	148
9.7	CO2 Cell Assembly – (PN: H014150) .....	149
9.8	Source Timing Assembly – (PN: H014160) .....	150
9.9	Calibration Manifold Assembly – (PN: H010013-01) .....	151
9.10	Valve Assembly – (PN: H010042).....	152
9.11	High Pressure Valve Exploded View – (PN: H050043) .....	153
9.12	Sample Filter – (PN: H010160).....	154

## List of Figures

Figure 1 – Measurement Cell Theory .....	23
Figure 2 – Correlation Wheel .....	23
Figure 3 – Internal Components Diagram .....	25
Figure 4 – Ecotech Tubing .....	27
Figure 5 – Opening the Instrument .....	31
Figure 6 – Instrument Rear Panel.....	33
Figure 7 – Travel Screw Locations .....	36
Figure 8 – Installation of USB Memory Stick.....	38
Figure 9 – Switching the Battery On/Off .....	39
Figure 10 – Front Panel .....	42
Figure 11 – Home Screen .....	44
Figure 12 – Chart Screen .....	66
Figure 13 – Communication Ports.....	71
Figure 14 – Multidrop RS232 Cable Example .....	72
Figure 15 – Example of Typical Network Setups .....	73
Figure 16 – Example of Network Menu Setup .....	75
Figure 17 – Port Forwarding Example .....	75
Figure 18 – LAN Network Set-Up (Airodis) .....	76
Figure 19 – WAN Network Set-Up (Airodis) .....	76
Figure 20 – 25 Pin Rear Panel PCA (Default Jumpers Highlighted) .....	78
Figure 21 – External 25 Pin I/O Individual Pin Descriptions .....	79
Figure 22 – Installing Driver Software (Device Manager) .....	80
Figure 23 – Update Driver Popup .....	81
Figure 24 – Update Driver Popup (Directory Location).....	81
Figure 25 – Installing Driver Confirmation Prompt .....	82
Figure 26 – Successful Driver Installation .....	82
Figure 27 – Airodis Workspace Manager .....	84
Figure 28 – Adding a New Station .....	84
Figure 29 – New Station Connection.....	85
Figure 30 – Station Configuration (Channel List) .....	86
Figure 31 – Error Status Notification.....	86
Figure 32 – Downloading Data .....	87
Figure 33 – Download Data Status .....	87
Figure 34 – Data Visibility .....	88
Figure 35 – Exporting Data .....	88
Figure 36 – Data Download Complete .....	89
Figure 37 – Downloading the App From Google Play Store.....	90
Figure 38 – Bluetooth Pairing Request.....	90
Figure 39 – Showing or Hiding the NumPad .....	91
Figure 40 – Switching Analysers .....	92
Figure 41 – Real-Time Plot .....	93
Figure 42 – Plot of Downloaded Data .....	94

Figure 43 – Directory Settings .....	95
Figure 44 – Logs Format .....	95
Figure 45 – Colour Theme Settings.....	96
Figure 46 – Example of a Calibration System .....	97
Figure 47 – Excel Graph of Multipoint Precision Check.....	107
Figure 48 – Single High Pressure Calibration Option.....	109
Figure 49 – Dual High Pressure Calibration Option .....	110
Figure 50 – Minifit Extraction Tool – (PN: T030001) .....	113
Figure 51 – Orifice/Sintered Filter Removal Tool – (PN: H010046).....	114
Figure 52 – Orifice/Sintered Filter Insertion Tool – (PN: T030015).....	114
Figure 53 – Leak Test Jig – (PN: H050069).....	114
Figure 54 – Air Monitoring Test Equipment Kit (AMTEK) – Customisable .....	114
Figure 55 – Removing the Plunger .....	116
Figure 56 – Removing the Fan Filter.....	116
Figure 57 – Leak Test Jig on Exhaust .....	117
Figure 58 – Kynar Fitting Containing Orifice and Sintered Filter .....	119
Figure 59 – Test Point Location .....	122
Figure 60 – Flow Fault Diagnostic Procedure .....	128
Figure 61 – Noisy Zero or Unstable Span Diagnostic Procedure .....	129
Figure 62 – Cell Temperature Failure Diagnostic Procedure.....	130
Figure 63 – Mirror Temperature Failure Diagnostic Procedure .....	131
Figure 64 – USB Memory Stick Failure .....	132
Figure 65 – USB Memory Stick File Structure.....	134
Figure 66 – Dual Filter Option Installed.....	135
Figure 67 – Separate Rack Slides .....	137
Figure 68 – Assemble Inner Slide on Chassis.....	137
Figure 69 – Rack Mount Ears Fitted to Instrument .....	138
Figure 70 – Attach Rack Mount Adaptors to Outer Slides.....	138
Figure 71 – Test Fit the Rack Slide Assembly into the Rack.....	139
Figure 72 – Attach Slides to Front of Rack.....	139
Figure 73 – Slide Clips .....	140

## List of Tables

Table 1 – Internationally Recognised Symbols .....	11
Table 2 – Manual Revision History .....	17
Table 3 – Measurements: Background and Sample Cycles .....	41
Table 4 – Digital Output States.....	63
Table 5 – New Station Setup .....	85
Table 6 – Maintenance schedule.....	115
Table 7 – Troubleshoot List .....	125
Table 8 – Included Parts (Rack Mount Kit) .....	136
Table 9 – Internal Pump Additional Components .....	141
Table 10 – Internal Pump Removed Components.....	141



---

Table 11 – Serinus Accessories Kit – (PN: H010136) .....	143
Table 12 – Serinus 31 Maintenance Kit – (PN: E020208) .....	143
Table 13 – Serinus 31 Consumables .....	144
Table 14 – Spare Parts List Serinus 31 .....	144
Table 15 – Packet Format .....	155
Table 16 – Example: Primary Gas Request .....	155
Table 17 – Example: Primary Gas Response .....	156
Table 18 – Example: Primary Gas Response (continued) .....	156
Table 19 – List of Errors .....	156
Table 20 – Example: Get IEEE Response data .....	157
Table 21 – Advanced Protocol Parameter List .....	158
Table 22 – Bayern-Hessen Data .....	173
Table 23 – Block Check Operation .....	174
Table 24 – Status Bit Map .....	175
Table 25 – Failure Bit Map (Positive Logic) .....	175
Table 26 – Modbus Error Codes .....	179

## List of Appendices

<b>Appendix A. Advanced Protocol</b> .....	<b>155</b>
A.1 Command Format .....	155
A.2 Commands .....	156
A.3 List of Parameters .....	158
<b>Appendix B. EC9800 Protocol</b> .....	<b>171</b>
B.1 Command Format .....	171
B.2 Commands .....	171
<b>Appendix C. Bayern-Hessen Protocol</b> .....	<b>173</b>
C.1 Command Format .....	173
C.2 Commands .....	174
<b>Appendix D. ModBus Protocol</b> .....	<b>177</b>
D.1 Command Format .....	177
D.2 Commands .....	178

## Manufacturer's Statement

Thank you for selecting the Ecotech Serinus 31 Carbon Dioxide Analyser.

The Serinus series is the next generation of Ecotech designed and manufactured gas analysers. The Serinus 31 will perform CO<sub>2</sub> measurements over a range of 0-3000 ppm with a lower detectable limit of 0.2 ppm.

This User Manual provides a complete product description including operating instructions, calibration and maintenance requirements for the Serinus 31 Carbon Dioxide Analyser. This manual is valid for the most recent version of the Serinus 31 which includes the new Autoranging Power Supply, Main Controller PCA and Rear Panel PCA.

Reference should also be made to the relevant local standards which should be used in conjunction with this manual. Some of these standards are listed in this manual.

If, after reading this manual you have any questions or you are still unsure or unclear on any part of the Serinus 31, please do not hesitate to contact Ecotech or your local Ecotech distributor.



Please help the environment and recycle the pages of this manual when you have finished using it.

## Notice

The information contained in this manual is subject to change without notice. Ecotech reserves the right to make changes to equipment construction, design, specifications and/or procedures without notification.





Copyright © 2020. All rights reserved. Reproduction of this manual, in any form, is prohibited without the written consent of Ecotech Pty Ltd.

## Safety Information

Read all the safety information in this section prior to using the equipment. To reduce the risk of personal injury caused by potential hazards, follow all safety notices and warnings in this documentation.

The following internationally recognised symbols are used on Ecotech equipment:

**Table 1 – Internationally Recognised Symbols**

	Protective conductor terminal	IEC 60417-5017
	Alternating current	IEC 60417-5032
	Caution, hot surface	IEC 60417-5041
	Caution, risk of danger to user and/or equipment Refer to any accompanying documents	ISO 7000-0434
	Caution, risk of electric shock	ISO 3864-5036

These symbols will also be found throughout this manual to indicate relevant safety messages.

**Note:** Notes are used throughout this manual to indicate additional information regarding a particular part or process.

If the equipment is used for purposes not specified by Ecotech, the protection provided by this equipment may be impaired.

## Important Safety Messages



### **Disconnect Power Prior to Service**

Hazardous voltages exist within the instrument. Do not remove or modify any of the internal components or electrical connections whilst the mains power is on.

Always unplug the equipment prior to removing or replacing any components.



### **Replacing Parts**

Replacement of any part should only be carried out by qualified personnel, using only parts specified by Ecotech, as these parts meet stringent Ecotech quality standards.



### **Mains Supply Cord**

Do not replace the detachable mains supply cord with an inadequately rated cord. Any mains supply cord that is used with the instrument must comply with the safety requirements (250 V / 10 A minimum requirement). A mains power cord with a protective earth conductor must be used.

Ensure that the mains supply cord is maintained in a safe working condition.



### **Do Not Expose Equipment to Flammable Gases**

This equipment is not intended for use in explosive environments, or conditions where flammable gases are present. The user should not expose the equipment to these conditions. Do not introduce any flammable gases into the instrument, otherwise serious accidents such as explosion or fire may result.



### **Electromagnetic Compliance**

The instrument lid should be closed when in normal operation, to comply with EMC regulations.



### **Means of Lifting/Carrying Instrument**

This instrument is a heavy and bulky object. Two persons should lift/carry the object, otherwise use proper lifting equipment. Proper lifting techniques should be used when moving the instrument.



### **Internal Components**

Do not insert a rod or finger into the cooling fans, otherwise injury may result.

Do not energise the instrument until all conductive cleaning liquids, used on internal components, are dried up.

## Warranty

This product has been manufactured in an ISO 9001/ISO 14001 facility with care and attention to quality.

The product is subject to a 24-month warranty on parts and labour from date of shipment. The warranty period commences when the product is shipped from the factory. Lamps, filters and other consumable items are not covered by this warranty.

Each instrument is subjected to a vigorous testing procedure prior to despatch and will be accompanied with a parameter list and a multipoint precision check, thereby enabling the instrument to be installed and ready for use without any further testing.

## Service & Repairs

Our qualified and experienced technicians are available to provide fast and friendly service between the hours of 8:30 am – 5:00 pm AEST Monday to Friday. Please contact either your local distributor or Ecotech regarding any questions you have about your instrument.

### Service Guidelines

This manual is designed to provide the necessary information for the setup, operation, testing, maintenance and troubleshooting of your instrument.

Should you still require support after consulting the documentation, we encourage you to contact your local distributor for support.

To contact Ecotech directly, please e-mail our Technical Support Specialist group at [support@ecotech.com](mailto:support@ecotech.com) or to speak with someone directly:

Please dial 1300 364 946 if calling from within Australia.

Please dial +61 3 9730 7800 if calling from outside of Australia.

Please contact Ecotech and obtain a Return Material Authorisation (RMA) number before sending any equipment back to the factory. This allows us to track and schedule service work and to expedite customer service. Please include this RMA number when you return equipment, preferably both inside and outside the shipping packaging. This will ensure you receive prompt service.

When shipping instrumentation, please also include the following information:

- Name and phone number
- Company name
- Shipping address
- Quantity of items being returned
- Model number/s or a description of each item
- Serial number/s of each item (if applicable)
- A description of the problem and any fault-finding completed
- Original sales order or invoice number related to the equipment

Shipping Address:

Attention Service Department

Ecotech Pty Ltd

1492 Ferntree Gully Road,

Knoxfield, VIC, Australia 3180.

## Product Compliance and Approvals

The Serinus 31 Carbon Dioxide Analyser, as manufactured by Ecotech Pty Ltd, complies with the essential requirements of the directives listed below (including CE compliance). The respective standards have been applied:



### Low Voltage Directive (LVD) Directive 2014/35/EU

**EN 61010-1:2010**

Safety requirements for electrical equipment, for measurement, control and laboratory use – General requirements

### Electromagnetic Compatibility (EMC) Directive 2014/30/EU

**EN 61326-1:2013**

Electrical equipment for measurement, control and laboratory use – EMC requirements – General requirements

### Radio Equipment Directive (RED) 2014/53/EU

**EN 300 328 V2.1.1**

Wideband transmission systems – Data transmission equipment operating in the 2.4 GHz ISM band and using wide band modulation techniques



### Regulatory Compliance Mark (RCM) - Australia

**AS/NZS 4268:2017**

Radio equipment and systems – Short range devices – Limits and methods of measurement

**ARPANSA  
Radiation Protection Standard**

Maximum Exposure Levels to Radiofrequency Fields – 3 kHz to 300 GHz – Radiation Protection Series Publication No. 3: 2002

## Claims for Damaged Shipments and Shipping Discrepancies

### Damaged Shipments

Inspect all instruments thoroughly on receipt. Check materials in the container/s against the enclosed packing list. If the contents are damaged and/or the instrument fails to operate properly, notify the carrier and Ecotech immediately.

The following documents are necessary to support claims:

- Original freight bill and bill of lading
- Original invoice or photocopy of original invoice
- Copy of packing list
- Photographs of damaged equipment and container

You may want to keep a copy of these documents for your records.

Please refer to the instrument name, model number, serial number, sales order number and your purchase order number on all claims.

You should also:

- Contact your freight forwarder for an insurance claim
- Retain packing material for insurance inspection

### Shipping Discrepancies

Check all packages against the packing list immediately on receipt. If a shortage or other discrepancy is found, notify the carrier and Ecotech immediately. Ecotech will not be responsible for shortages against the packing list unless they are reported within seven days.

### Contact Details

#### Head Office

1492 Ferntree Gully Road, Knoxfield, VIC Australia 3180

Phone: +61 (0)3 9730 7800 Fax: +61 (0)3 9730 7899

Email: [info@ecotech.com](mailto:info@ecotech.com)

Service: [service@ecotech.com](mailto:service@ecotech.com)

Support: [support@ecotech.com](mailto:support@ecotech.com)

[www.ecotech.com](http://www.ecotech.com)



## Manual Revision History

Manual PN: M010065  
Current revision: 3.0  
Date released: 6 October 2020  
Description: User Manual for the Serinus 31 Carbon Dioxide Analyser

This manual is the full user manual for the Serinus 31 Carbon Dioxide Analyser. This manual contains all relevant information on theory, specifications, installation, operation, maintenance and calibration. Any information that cannot be found within this manual can be obtained by contacting Ecotech.

This manual uses cross reference links extensively throughout this manual. The hot keys below will greatly reduce the amount of time scrolling between references:

- You can access the links by pressing the following:  
CTRL + LEFT MOUSE CLICK: Move to the link location
- You can switch between links by pressing the following:  
ALT + LEFT ARROW KEY: Returns you to previous Link  
ALT + RIGHT ARROW KEY: Swaps back

**Table 2 – Manual Revision History**

Edition	Date	Summary
3.0	October 2020	Initial release, Firmware 4.04, Board Revision N

This page is intentionally blank

# 1. Introduction

---

## 1.1 Description

---

The Ecotech Serinus 31 Carbon Dioxide Analyser uses Non-Dispersive Infrared Spectrophotometry (NDIR) technology to measure CO<sub>2</sub> in ambient air, in the range of 0-3000 ppm.

This section will describe the specifications of the instrument as well as the main components and techniques used to obtain stable gas concentration readings.

---

## 1.2 Specifications

---

### 1.2.1 Measurement

#### Range

0-3000 ppm autoranging

Lower detectable limit: 0.2 ppm (200 ppb), with Kalman filter active

### 1.2.2 Precision/Accuracy

#### Precision

0.2 ppm or 0.5 % of reading, whichever is greater

#### Linearity

Better than  $\pm 1$  % of full scale, from best straight-line fit

#### Noise at Zero

0.1 ppm

#### Response Time

60 seconds to 95 %

#### Sample Flow Rate

1.0 slpm

### 1.2.3 Calibration

#### Zero Drift

24 hours: < 1 ppm

#### Span Drift

7 days: 0.5 % of reading or 1 ppm, whichever is greater

#### 1.2.4 Power

##### Operating Voltage

100-240 V AC ( $\pm 10\%$ )

50 to 60 Hz

Overvoltage Category II

##### Power Consumption

190 W max (typical at start up)

150 VA after warm-up

#### 1.2.5 Operating Conditions

**Ambient Temperature** 0 °C to 40 °C (32 °F to 104 °F)

**Relative Humidity** 10 % to 80 % (non-condensing)

**Pollution Degree** 2

##### Sample Pressure Dependence

5 % change in pressure produces less than a 1 % change in reading

Maximum altitude: 2000 m<sup>1</sup> above sea level

#### 1.2.6 Communications

##### Analog Output

Three menu selectable current or voltage analog outputs.

- Current output of 0-20 mA, 2-20 mA or 4-20 mA.
- Voltage output of 0 to 5 V, with menu selectable zero offset of 0 V, 0.25 V or 0.5 V.
- Voltage output of 0 to 10 V (configured using jumpers (JP3) on rear panel PCA).
- Range: 0 to full scale from 0-1 ppm to 0-3000 ppm.

##### Analog Input

- Three analog voltage inputs (0-5 VDC) CAT I rated.

##### Digital Output

- RS232 port #1: Normal digital communication.

---

<sup>1</sup> Contact Ecotech for options at higher altitudes

- RS232 port #2: Multidrop port used for multiple instrument connections on a single RS232.
- USB port connection on rear panel.
- TCP/IP port (optional).
- USB memory stick (front panel) for data logging, event logging, parameter and configuration storage.
- 25 pin connector with discrete status and user control.
  - o Eight Digital Outputs, open collector max 400 mA each @ 12 VDC (max total output 2 A).
  - o Eight Digital Inputs, 0-5 VDC, CAT I rated.

### 1.2.7 Physical Dimensions

#### Case Dimensions

Rack length (front to rear):	597 mm (23.5")
Total length (with latch release):	638 mm (25.1")
Chassis width:	418 mm (16.5")
Front panel width:	429 mm (16.9")
Chassis height:	163 mm/Uses 4 RU (6.4")
Front panel height:	175 mm (6.9")
Weight:	21.3 kg

### 1.2.8 Certifications

As Carbon Dioxide is not a criterion gas, this instrument has no applicable specific measurement certification; however it is very similar in design to the Ecotech Serinus 30 Carbon Monoxide analyser which has the following approvals:

- U.S. EPA approved (RFCA-0509-174)
- EN approval (TUV 936/21221977/D)
- Non Dispersive I.R. Spectrometry method EN1426
- Determination of carbon monoxide AS 3580.7.1.2011 Australian/New Zealand standards

---

## 1.3 Nomenclature

---

CO <sub>2</sub> :	Carbon dioxide.
Span:	A gas sample of known composition and concentration used to calibrate/check the upper range of the instrument (carbon dioxide).
Zero:	Zero calibration uses zero air (CO <sub>2</sub> scrubbed ambient air) to calibrate/check the lower range of the instrument.
Background:	Draws air from the background port to compensate for changes in the IR source and background interferences.
Multipoint Precision Check:	A procedure to verify the linearity of the instrument.

Calibration:	The process of adjusting the instrument to ensure that it is measuring the correct concentration.
Zero Drift:	The change in the instruments response to zero air over a period of continuous unadjusted operation.
Automatic Zero:	The automatic zero performs a zero check at a specified time through a 24 hour cycle which adjusts the lower limit of the instrument.
Zero Air:	Is purified air in which the concentration of CO <sub>2</sub> is <0.1 ppm with water vapour of less than 10 % RH. This is usually supplied through an external scrubber filled with soda lime or a combination of two scrubbers 13X and soda lime.
External Span Source:	Span gas that is delivered via an external accredited cylinder (e.g. NATA/NIST).
Sample Air:	Sample air is defined as the sample before it has entered the Measurement cell, as distinguished from the exhaust air.
Exhaust Air:	Exhaust air is the sample air after it has passed through the reaction/measurement/detection cell and is moving towards being expelled from the instrument.
ID and OD:	These are measurements of tubing. ID is the internal diameter of tubing, OD is the outer diameter.
Multidrop:	A configuration of multiple instruments connected via the same RS232 cable.
Bootloader:	A program that checks whether the current firmware is valid and executes the instrument start-up. The Bootloader can be entered by pressing the '+' key on the front keypad during the first ½ second after power on and following the prompts. The Bootloader enables various low level recovery tools, including updating the firmware from a USB stick.
PCA:	Printed Circuit Assembly. An electronic circuit mounted on a printed circuit board to perform a specific electronic function.
IR:	Infrared. The region of the optical spectrum with a wavelength from 0.75 – 1000 microns.
slpm:	Standard litres per minute. This is the flow referenced to standard temperature and pressure conditions. For the purposes of this manual, all flows are referenced to 0 °C and 101.3 kpa (1 atm).

---

## 1.4 Background/Theory

---

Carbon dioxide is a colourless, odourless (at ambient concentrations) gas. It is produced by respiration, decay of organic materials, and combustion of fossil fuels. It is the most significant long-lived greenhouse gas in the atmosphere.

### 1.4.1 Measurement Theory

The measurement of carbon dioxide is completed via the following principles and measurement techniques:

CO<sub>2</sub> absorbs infrared (IR) radiation at a wavelength near 4.4 microns. Broadband IR radiation from the IR source is passed through a five metre folded path length through sample air and focused on

the IR detector. The strength of the signal received is proportional to the amount of CO<sub>2</sub> in the sample. A narrow band pass filter is fitted to the signal detector to ensure only light with a wavelength near 4.4 microns is detected.

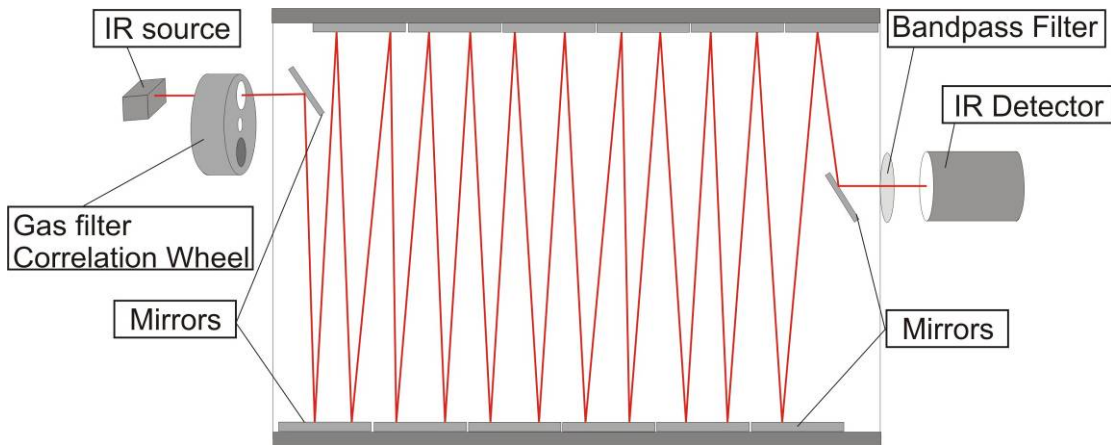

**Figure 1 – Measurement Cell Theory**

A gas filter correlation wheel is combined with this system. This wheel contains three parts to increase measurement accuracy: CO<sub>2</sub>, N<sub>2</sub> and the mask.

- The CO<sub>2</sub> window contains saturation (100 %) of CO<sub>2</sub>, which acts as a reference beam – absorbing a known amount of light.
- The N<sub>2</sub> window, containing 100 % N<sub>2</sub>, which does not absorb IR at 4.4 microns at all and is used during normal CO<sub>2</sub> measurement.
- The mask totally blocks the light source and is used to determine background signals, the strength of other signals relative to each other and the background.

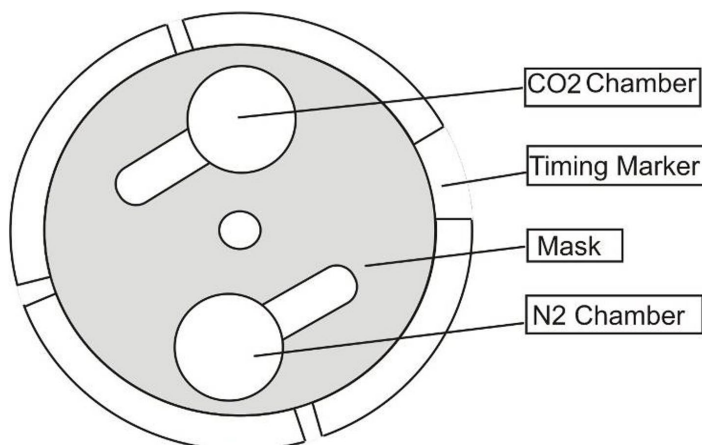

**Figure 2 – Correlation Wheel**

### 1.4.2 Kalman Filter Theory

The digital Kalman filter provides an ideal compromise between response time and noise reduction for the type of signal and noise present in ambient air analysers.

The Kalman filter enhances measurements by modifying the filter time base variable, depending on the change rate of the measured value. If the signal is changing rapidly, the instrument is allowed to respond quickly. When the signal is steady, a long integration time is used to reduce noise. The system continuously analyses the signal and uses the appropriate filtering time.



## 1.5 Instrument Description

The major components of the Serinus 31 are described below:

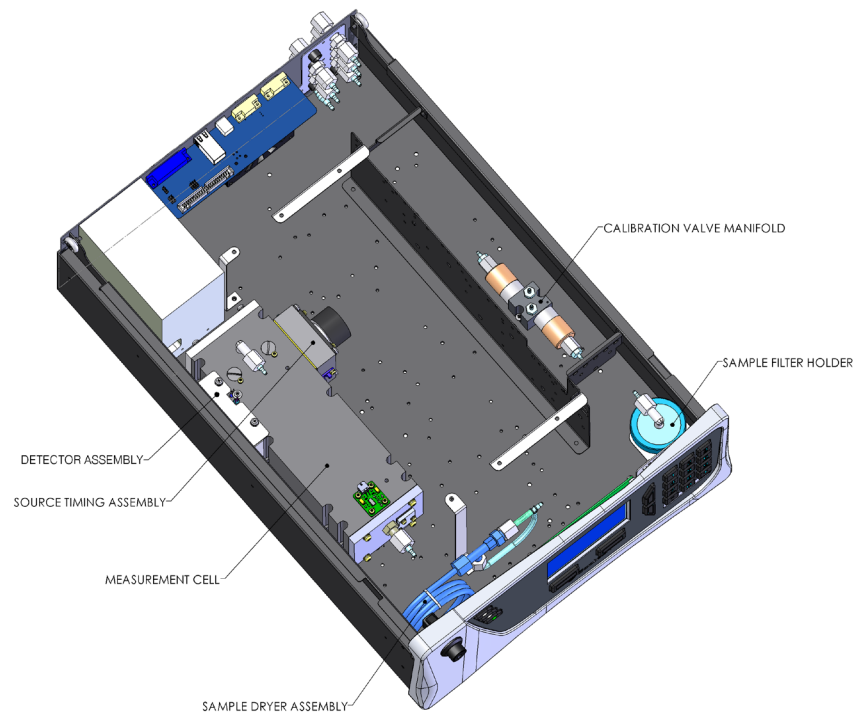

**Figure 3 – Internal Components Diagram**

### 1.5.1 Calibration Valve Manifold

The calibration valve manifold switches between sample, calibration and background gas.

### 1.5.2 Sample Filter Holder

Within the sample filter holder is a particulate filter. The particulate filter is a PTFE 5 micron ( $\mu\text{m}$ ) filter with a diameter of 47 mm. This filter prevents all particles larger than 5  $\mu\text{m}$  from entering the measurement system that could interfere with sample measurement.

### 1.5.3 Sample Dryer Assembly

The sample dryer utilises a Nafion tubing and is designed to remove water vapour from the sample before it is drawn through the measurement cell. Water is absorbed and moves through the walls of the tubing, evaporating into the surrounding air. The remaining gas is unaffected. The flow control is performed by utilising a critical orifice located in the outlet fitting of the Measurement cell.

The output flow of the measurement cell is drawn through the sample dryer once again and is used as the purge air to extract the surrounding air, before exiting through the exhaust.

### 1.5.4 Measurement Cell

The measurement cell consists of the following components:

Cell Assembly	Refer to Section 1.5.4.1.
Source Timing Assembly	Refer to Section 1.5.4.2.
Detector Assembly	Refer to Section 1.5.4.3.

#### 1.5.4.1 Cell Assembly

### Cell Assembly

The measurement cell assembly contains five mirrors that form a five meter folded path length through the cell. The sample gas is drawn through the cell filling the chamber and the IR light travels through the sample. The Cell is maintained at a set temperature based on the cell set point, default is 50 °C. The cell pressure is monitored to compensate for pressure changes.

The mirror alignment in cell assembly is critical and is factory aligned. No attempt should be made to do a field adjust to the mirrors. Doing so will void the warranty.



#### CAUTION

Manually adjusting any of the mirrors or trying to access the internals of this assembly may result in damage and will void the warranty.

#### 1.5.4.2 Source Timing Assembly

The source timing assembly consists of the following:

Refer to Section 9.8.

### IR Source

The IR source emits broadband infrared radiation that irradiates the filter in the correlation wheel.

### Gas Filter Correlation Wheel Assembly

The gas filter correlation wheel contains three segments: a N<sub>2</sub> filled sapphire chamber, a CO<sub>2</sub> filled sapphire chamber and a mask.

- The N<sub>2</sub> chamber allows all the IR radiation to pass through, which allows the radiation to be absorbed by CO<sub>2</sub> in the measurement cell and readings to be recorded.
- The CO<sub>2</sub> filled chamber absorbs wavelengths sensitive to CO<sub>2</sub>. The sample gas (containing CO<sub>2</sub>) in the measurement cell does not receive CO<sub>2</sub> specific IR radiation and the only detected signals registered by the IR detector are from background sources and interference.
- The mask blocks all IR light entering the cell. This allows the intensity of the other two signals to be corrected for the detector response to no IR radiation.

## Opto-Detector

The correlation wheel has four tabs that act as an opto electronic switch ensuring that the main controller PCA can determine accurate timing of the wheel and the segment currently exposed to the IR radiation.

## Motor Assembly

The motor that drives the correlation wheel is a 12 VDC Brushless motor.

## Purge Port

The main body of the source timing assembly has a Kynar barb fitting which connects to the Aux In port on the rear of the instrument. This is used to reject local interference from CO<sub>2</sub> in the ambient air.

### 1.5.4.3 Detector Assembly

The detector assembly consists of the following:

#### Narrow-Bandpass Filter

The narrow bandpass filter allows only the CO<sub>2</sub> sensitive portion of the IR radiation to pass through to the IR detector (4.4 microns) reducing noise and interference.

#### IR Detector

The IR detector is a cooled lead selenide (PbSe) photoconductive IR detector. It creates an electrical signal when wavelengths centred at 4.4 microns reach it.

### 1.5.5 Pressure Sensor PCA

An absolute-pressure transducer is mounted on the measurement cell and used to measure the sample pressure in the cell. This pressure is used to check for flow and correct readings for pressure variations.

### 1.5.6 Pneumatic Tubing

The pneumatic tubing inside this instrument is specially designed for use in Ecotech Serinus instruments. It has the flexibility of Silicone tubing with the added inner sheath of PVDF to prevent contamination of the sample. Care should be taken when removing and inserting the tubing into the barbed fittings.

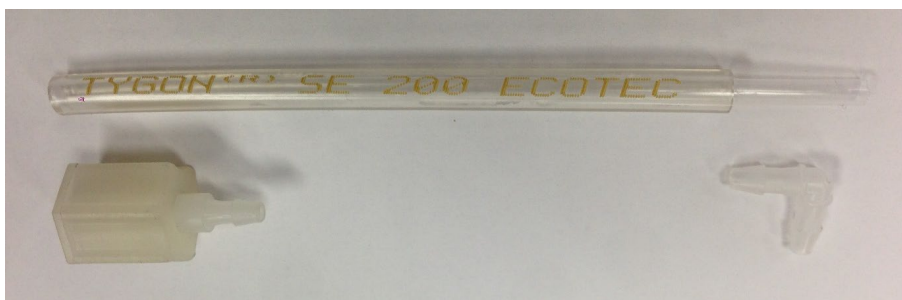

**Figure 4 – Ecotech Tubing**

### 1.5.7 Main Controller PCA

The main controller PCA controls all the processes within the instrument. As well as the on-board microprocessor, it contains a battery backed clock, calendar analog to digital converters and many other circuits for signal processing and control. The ambient pressure and chassis temperature sensors are also located on this board. The main controller PCA is located above all other components within the instrument. It pivots on hinges to allow access to the components underneath. The current revision of the main controller PCA for which this manual applies, has many differences to previous revisions, highlighted by the many vacant component locations on the PCA.



#### CAUTION

Never place objects on top of the main controller PCA as it may result in damage.

### 1.5.8 Power Supply

The power supply is a self-contained unit housed in a steel case designed to meet all the relevant safety and EMC requirements. The new revision of power supply is different to the previous revision as there is no need to set the operating voltage switch because it is autoranging.

The output of the power supply provides +12 V, +5 V, -12 V and +3.3 V to the instrument.

### 1.5.9 On/Off Switch

The on/off switch is located on the back panel (bottom right facing the rear of the instrument). It is part of the power supply.

### 1.5.10 Communications

Communication between the instrument and either a data logger, laptop or network can be performed with the following communication connections located on the back panel (refer to Figure 6). These connections can be used for downloading data, onsite diagnostics, maintenance and firmware upgrades.

#### RS232 #1

This port is designed to be used for simple RS232 communication.

#### RS232 #2

This port is designed to be used for simple RS232 communication or in multidrop configuration.

#### USB

This port can be used for instrument communications with equipment through a standard USB port.

#### TCP/IP Network (optional)

This port is best used for remote access and real-time access to instruments when a network is available to connect with.

## Analog and Digital I/O

The analog/digital port sends and receives analog/digital signals to other devices. These signals are commonly used to activate gas calibrators or for warning alarms.

### Analog Outputs

The instrument is equipped with three user definable analog outputs. The outputs are menu selectable as voltage output 0-5, 0.25-5 or 0.5-5 VDC or current output 0-20, 2-20 or 4-20 mA. The current output can also be configured as a voltage output of 0 to 10 V, by configuring the jumpers (JP3) on the rear panel PCA.

Refer to Section 4.4 for more detail.

### Analog Inputs

The instrument is also equipped with three analog voltage inputs (0-5 VDC CAT 1) with resolution of 15 bits plus polarity.



#### CAUTION

Exceeding these voltages can permanently damage the instrument and void the warranty.

### Digital Status Inputs

The instrument is equipped with eight logic level inputs (0–5 VDC CAT 1) for the external control of zero/span calibration sequences.



#### CAUTION

Exceeding these voltages can permanently damage the instrument and void the warranty.

### Digital Status Outputs

The instrument is equipped with eight open collector outputs, which will convey instrument status conditions and warning alarms such as no flow, sample mode, etc.



#### CAUTION

Exceeding 12 VDC or drawing greater than 400 mA on a single output or a total greater than 2 A across the eight outputs can permanently damage the instrument and void the warranty.

### Bluetooth

This allows for remote access of the instrument to any Android device with the Serinus Remote Application installed on it. It uses Bluetooth to control the instrument, view parameters, download data and construct real-time graphs.

This page is intentionally blank

## 2. Installation

### 2.1 Initial Check

#### Packaging

The Serinus 31 is transported in packaging specifically designed to minimise the effects of shock and vibration during transportation. Ecotech recommends that the packaging be kept if there is a likelihood that the instrument is going to be relocated.

**Note:** The red plastic caps that seal the pneumatic connections during transport must be removed prior to operation.

#### Opening the Instrument

Check the interior of the instrument with the following steps:

1. Undo the screws located on the rear panel.
2. Open the chassis lid by releasing the latch (pressing the button) located on the front panel in the top left-hand corner, slide the lid backwards.
3. To completely remove; slide the lid backwards until the rollers line up with the gaps in the track and pull the lid upwards to remove from the instrument (refer to Figure 5).
4. Check that all pneumatic and electrical connectors are connected. If not, reconnect.
5. Check for any visible and obvious damage. If damage exists contact your supplier and follow the instructions in Claims for Damaged Shipments and Shipping Discrepancies at the front of this manual.

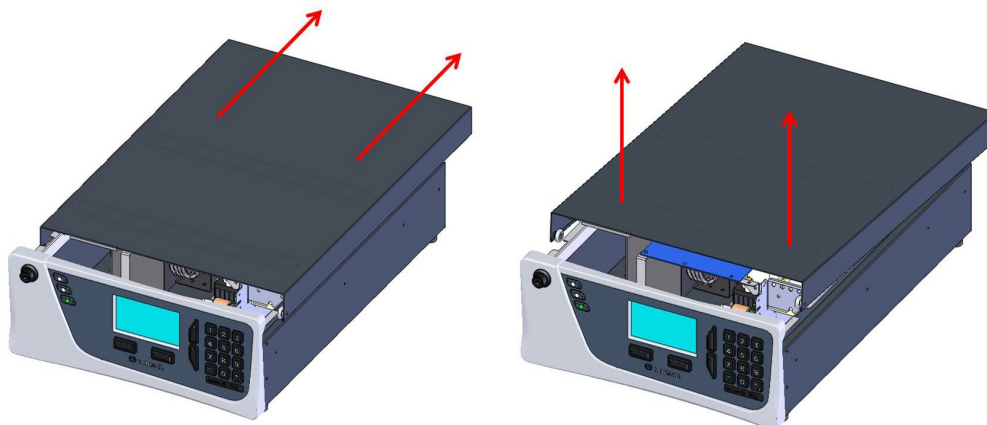

Figure 5 – Opening the Instrument

### Items Received

With the delivery of the Serinus 31, the user should have received the following:

- Ecotech Serinus 31 Analyser PN: E020031
- Green Ecotech Resources USB Stick PN: H030137-01
- Soda Lime Scrubber PN: 98415105-8
- End Caps PN: B010002
- Manual PN: M010065 (hardcopy optional)
- USB Memory Stick PN: H030021
- USB Cable PN: COM-1440
- Power Lead (120 V)\* USA PN: C040007
- Power Lead (240 V)\* Australia PN: C040009
- Europe PN: C040008
- UK PN: C040010

\*The power lead received depends on the mains supply of the country (120 V or 240 V).

**Note:** Check that all these items have been delivered undamaged. If any item appears damaged, please contact your supplier before turning the instrument on.

---

## 2.2 Installation Notes

---

When installing the instrument the following points must be taken into account:

- The instrument should be placed in an environment with minimal dust, moisture and variation in temperature.
- For best results the instrument should be located in a temperature and humidity controlled environment (air conditioned shelter). An enclosure temperature of 25-27 °C is optimum.
- Whether in a rack or placed on a bench, the instrument should not have anything placed on top of it or touching the case.
- Instruments should be sited with easy access to the front panel (instrument screen/USB memory stick) and to the rear panel (communication ports/pneumatic connections).
- It is recommended that the sample line be as short as possible and/or a heated manifold be used for sampling (minimising moisture condensation in the sample).
- Do not pressurise the sample line under any circumstances. Sample should be drawn through the instrument under atmospheric pressure. This should be achieved by either using the internal pump option (if installed) or an external vacuum pump connected to the exhaust port of the instrument.
- When supplying span gas, ensure the flow is approximately 1.5 slpm and excess is sufficiently vented.



- Undo the travel screws from the measurement cell as shown in the drawing supplied (refer to Section 2.3.4).

**Note:** The power on/off switch is accessible from the rear of the instrument only. Install the instrument so that the on/off power switch is accessible.

## 2.3 Instrument Set-Up

After installing the instrument the following procedures should be followed to ready the instrument for monitoring:

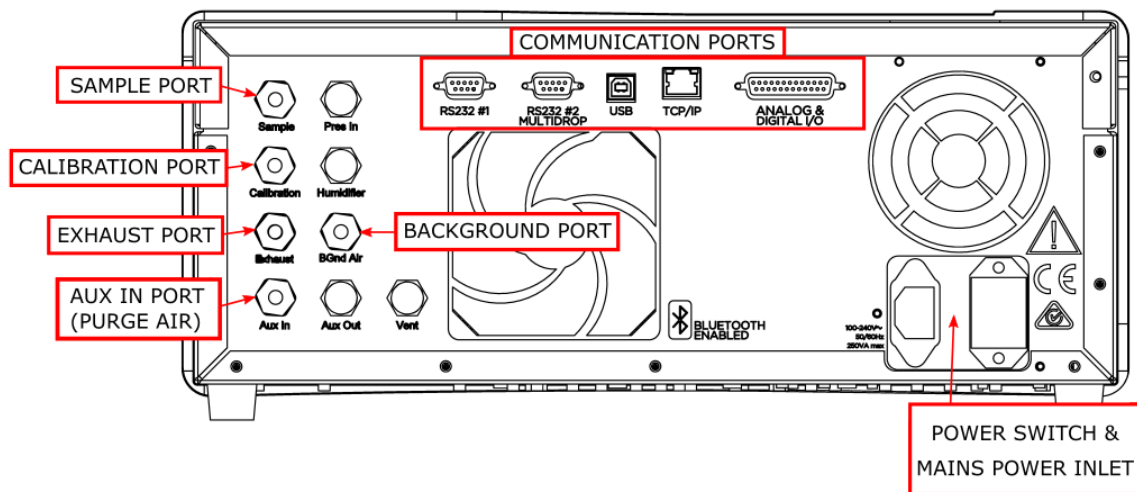

**Figure 6 – Instrument Rear Panel**

### 2.3.1 Pneumatic Connections

The Serinus 31 has five pneumatic ports on the back panel of the instrument: the Sample Port, the Calibration Port, the Exhaust Port, the Aux In Port and the Background Air Port. All tubing and fittings used should follow the instructions below:

- Must be made of Teflon® FEP material, Kynar®, stainless steel, glass or any other suitably inert material.
- Sample line should be no more than two meters in length with 1/8 inch ID and 1/4 inch OD.
- Sample inlet pressure should not exceed 5 kPa above ambient pressure.
- Tubing must be cut squarely and any burrs removed.
- Remove the inlet port nut and insert the tubing through the back of the nut with the tube extending one inch through the front.
- Place the tubing into the port until it hits the tube stop located inside the fitting.
- Place the nut back onto the fitting and tighten clockwise until finger tight.
- Nuts should be re-tightened when instrument reaches operating temperature.

## Sample Port

The sample port must be connected to an ambient source of sample air. When using a sample manifold the Serinus requires at least 1.5 slpm delivered to the sample manifold (1 slpm for measurement plus approximately 50 % excess).

## Calibration Port

The calibration port can be connected to the span/zero sources. It is recommended that a gas dilution calibrator (such as Ecotech's Serinus Cal 1000, 2000 or 3000) be used with a cylinder of carbon dioxide (CO<sub>2</sub>) to deliver precise concentrations of CO<sub>2</sub>.

**Note:** All connections to this port should not exceed ambient pressure. A vent is required for excess gas.

## Exhaust Port

The exhaust port is where the measured sample, calibration gases and background air are exhausted from the instrument. The exhaust port should be connected to the vacuum pump using ¼" OD tubing. The P030004 240 V vacuum pump (P030005 110 V) available from Ecotech, can be used to provide the required vacuum and flow for one Serinus 31 analyser as well as two other instrument such as a Serinus 10 or Serinus 50.



### CAUTION

It is recommended that exhaust air is expelled into an unoccupied area, as it may contain elevated levels of carbon dioxide. Furthermore, the exhaust must be a suitable distance from the sample inlet to avoid influencing the ambient measurements.

## Background Air Port

The background port is used to supply zero air to the instrument. This is used for backgrounds and internal zero calibration. A suitable source of scrubber air is essential for correct operation of the instrument. Soda lime scrubbers need regular replacement to maintain a good instrument zero.

## Aux In Port

The Aux In port is used to supply CO<sub>2</sub>-free 'Purge Air' to the instrument. This CO<sub>2</sub>-free purge air is required to reject local interference from CO<sub>2</sub> in the ambient air in the Gas Filter Correlation Wheel housing.

A suitable source of CO<sub>2</sub>-free air needs to be supplied at 15 psig max pressure to the Aux In port. The flow is controlled to 250-300 sccm by a critical orifice located in the Aux In bulkhead fitting. This setup is essential for correct operation of the instrument.

### 2.3.2 Power Connections



#### CAUTION

Hazardous voltages exist within the instrument. Do not remove or modify any of the internal components or electrical connections whilst the mains power is on.



#### CAUTION

Always unplug the equipment prior to removing or replacing any components.



#### CAUTION

Do not replace the detachable mains supply cord with an inadequately rated cord. Any mains supply cord that is used with the instrument must comply with the safety requirements (250 V/10 A minimum requirement).



#### CAUTION

Ensure that the mains supply cord is maintained in a safe working condition



#### CAUTION

When connecting the mains power to the instrument, the following must be adhered to otherwise the safety and the reliability of the instrument may be compromised.

- A three pin mains power cord with a protective earth conductor **MUST** be used
- The mains power outlet (wall socket) must be in the range of 100-240 VAC, 50 to 60 Hz
- The mains power outlet must be protected by an earth leakage protection circuit
- Connect the instrument's power cord into the mains power outlet and turn the power switch on.

### 2.3.3 Communications Connections

There are a number of ways to communicate with the instrument. Use the supplied Airodis software to access the instrument and download data. The Airodis software is supplied on the green Ecotech resources USB stick provided with this instrument.

#### RS232 #1

Connect this port to a data logger (such as Congrego) with an RS232 cable.

#### RS232 #2

Connect the RS232 cable from the instrument to a computer or data logger (such as Congrego) in a multidrop formation.

**Note:** When using multidrop ensure each instrument is given a unique **Serial ID**.

## USB

Connect a standard type B USB cable (supplied with the instrument) to this port.

## TCP/IP Network (optional)

Plug in an ethernet cable (this cable should be attached to a network).

## Analog and Digital I/O

This port is used to send and receive analog and digital signals. It is normally used to connect with a gas calibrator or to activate alarm signals.

Each instrument contains eight digital inputs, eight digital outputs, three analog inputs and three analog outputs.

## Bluetooth

Connection is enabled using Ecotech's Serinus Remote Android Application.

Use the Serinus Remote Android Application to access instrument and download data. It is available for download directly from the Google Play Store. Search for "Ecotech Serinus Remote".

### 2.3.4 Instrument Set-Up

1. Open the lid and ensure that the USB memory stick is installed (refer to Figure 8).
2. Remove the travel screws from the measurement cell. (store in a zip lock bag within the analyser)

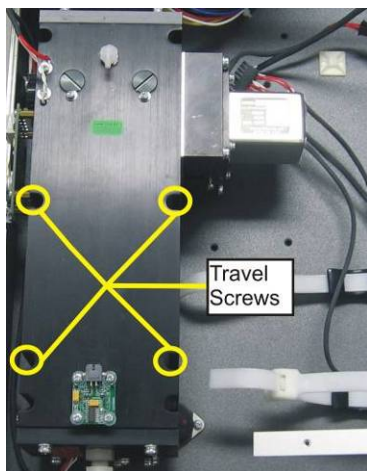

**Figure 7 – Travel Screw Locations**

3. Check that the battery is turned on at the main controller PCA (refer to Figure 9).
4. Turn on the instrument and allow the warm-up procedure to complete (refer to Section 3.1).
5. Set time and date (refer to Section 3.4.8).
6. Set the digital filter to desired setting (refer to Section 3.4.9).
7. Set the internal data logging options (refer to Section 3.4.23).

8. Set the analog and digital inputs and outputs settings (refer to Section 3.4.25, 3.4.26, 3.4.27 and 3.4.28).
9. Perform a pressure sensor check (refer to Section 6.4.7).
10. Perform a leak check (refer to Section 6.4.3).
11. Connect a pressurised (15 psig) source of zero air 'Purge Air' to the Aux In port (refer Section 2.3.1).
12. Connect a source of zero air vented to ambient or a scrubber (soda lime) open to ambient to the background air port (refer Section 2.3.1).
13. Leave the instrument to warm-up for at least three hours. Wait for a stable concentration measurement for at least one hour.
14. Perform a manual background (refer to Section 5.4).
15. Perform a span calibration (refer to Section 5.6).
16. Follow the procedure for a multipoint precision check (refer to Section 5.8).
17. The instrument is now ready for operation.

## 2.4 Transporting/Storage

---

Transporting the instrument should be done with great care. It is recommended that the packaging the instrument was delivered in should be used when transporting or storing.

When transporting or storing the instrument the following points should be followed:

1. Turn off the instrument and allow it to cool down.
2. Remove all pneumatic, power and communication connections.
3. If storing over a long period (six months) turn the battery off by moving the switch (S1) on the main controller PCA (refer to Figure 9).
4. Remove the instrument from the rack.
5. Replace the red plugs into the pneumatic ports.
6. If transporting the instrument, replace the travel screws (refer to Figure 7).
7. Remove the USB memory stick and pack with instrument. (For location refer to Figure 8)
8. Place the instrument back into a plastic bag with desiccant packs and seal the bag (ideally the bag supplied upon delivery).
9. Place the instrument back into the original foam and box it was delivered in. If this is no longer available find some equivalent packaging that provides protection from damage.
10. The instrument is now ready for long term storage or transportation.

**Note:** After transport or storage the instrument must be set-up and calibrated (refer to Section 2.3.4).

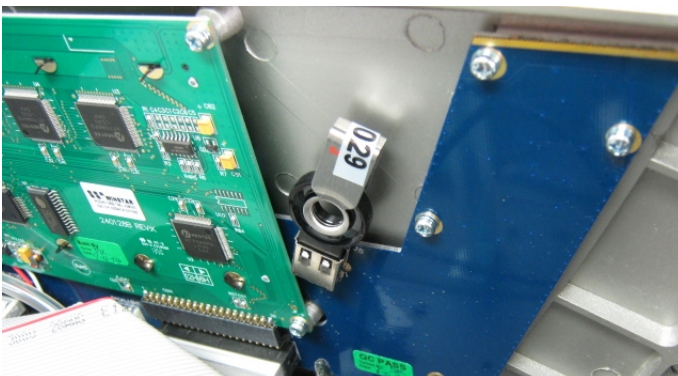

**Figure 8 – Installation of USB Memory Stick**

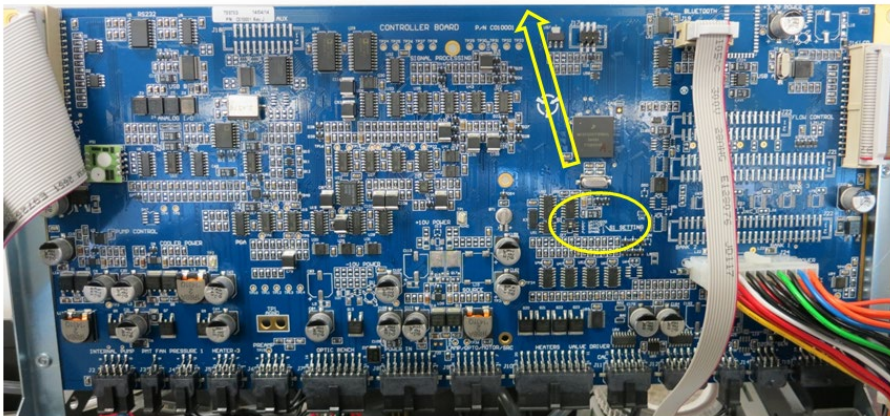

**Figure 9 – Switching the Battery On/Off**

This page is intentionally blank.



## 3. Operation

### 3.1 Warm-Up

When the instrument is first turned on it must go through a period of adjustment and calibration. No measurements are taken during this warm-up period.

The following activities occur during warm-up:

#### Ref. Adjust

Adjusts the reference voltage and internal trim pot setting

#### Cell Temperature

Wait until the cell temperature reaches at least 99 % of set point.

After this warm-up has completed the instrument will immediately begin making measurements (refer to Section 3.2).

### 3.2 Measurement

The Serinus 31 primarily operates in the sample cycle continuously. A background is performed after warm-up, once a day (at 23:45 as default) or when the chassis temperature changes by 4 °C. It is used to measure background absorption in the cell and is subtracted from sample measurements.

**Table 3 – Measurements: Background and Sample Cycles**

Instrument State	Duration (minutes)	Description
Background Fill	3	Measurement cell fills with background air
Background Meas	1	Measurement of background air
CO2 Sample Fill	3	Measurement cell fills with sample air
CO2 Sample Meas	Continuous	Measurement of sample air

---

## 3.3 General Operation Information

---

### 3.3.1 Keypad & Display

The instrument is operated with the use of four sets of buttons:

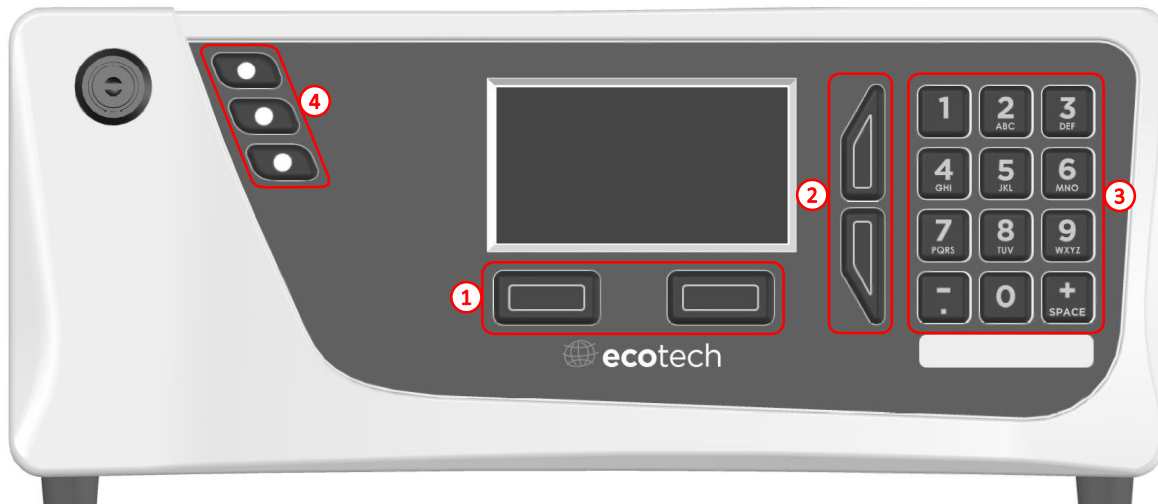

Figure 10 – Front Panel

#### Selection Buttons (1)

The selection buttons will perform the function specified directly above it on the screen. Generally this involves opening a menu, editing a value, accepting or cancelling an edit or starting an operation.

#### Scrolling Buttons (2)

The scrolling buttons allow users to scroll up and down through menus or selection boxes. The scrolling buttons are also used to scroll side to side through editable fields such as: Dates, Times, Numbers etc.

On the home screen these buttons are used for adjusting the screen contrast. Press and hold the up button to increase contrast; press and hold the down button to decrease.

#### Keypad (3)

The keypad contains the numbers 0-9, a decimal point/minus key (  $\bar{\cdot}$  ) and a space/plus key (  $\bar{\text{SPACE}}$  ).

In the few cases where letters can be entered, the number keys act like a telephone keypad. Every time a number key is pressed, it cycles through its choices. The up/down arrow keys scroll through all the numbers and the entire alphabet.

1 = 1, space, underline

2 = 2, A, B, C, a, b, c

3 = 3, D, E, F, d, e, f

4 = 4, G, H, I, g, h, i

5 = 5, J, K, L, j, k, l

6 = 6, M, N, O, m, n, o

7 = 7, P, Q, R, S, p, q, r, s

8 = 8, T, U, V, t, u, v

9 = 9, W, X, Y, Z, w, x, y, z

0 = 0, space, underline

The ( $\overset{+}{SPACE}$ ) and ( $\bar{\cdot}$ ) keys function is context dependent. When editing a floating point number, the ( $\bar{\cdot}$ ) key inserts a negative sign if the editing cursor is at the start of the number and negative signs are allowed. Otherwise it moves the decimal place to the current cursor location. The ( $\overset{+}{SPACE}$ ) key inserts a positive sign if the cursor is at the start of the number; otherwise it enters a space.

For non-floating point numbers, these keys usually increment or decrement the current value by 1.

When editing the month field of a date, the ( $\overset{+}{SPACE}$ ) and ( $\bar{\cdot}$ ) key change the month.

### Instrument Status Light Buttons (4)

Located in the top left corner, these lights indicate the status of the instrument as a whole.

- A red light indicates that the instrument has a major failure and is not functioning.
- An orange light indicates there is a minor problem with the instrument, but the instrument may still take measurements reliably.
- A green light indicates that the instrument is working and there are no problems.

In the case of an orange or red light, the user can enter the **Status Menu** to find which components are failing (refer to Section 3.4.4) or press the orange or red status light button when illuminated to bring up a pop up box with a full list of current faults.

Pressing the green status light button at any time will cancel any open edit box or menu and return the user to the home screen.

If no instrument status lights are on and the keypad is backlit, this indicates that the instrument is running the bootloader. The screen will also indicate that it is in the bootloader menu.

### 3.3.2 Home Screen

The home screen is composed of seven parts: readings (1), error/status line (2), instrument activity line (3), selection buttons (4), time/date (5), concentration units (6) and USB status (7).

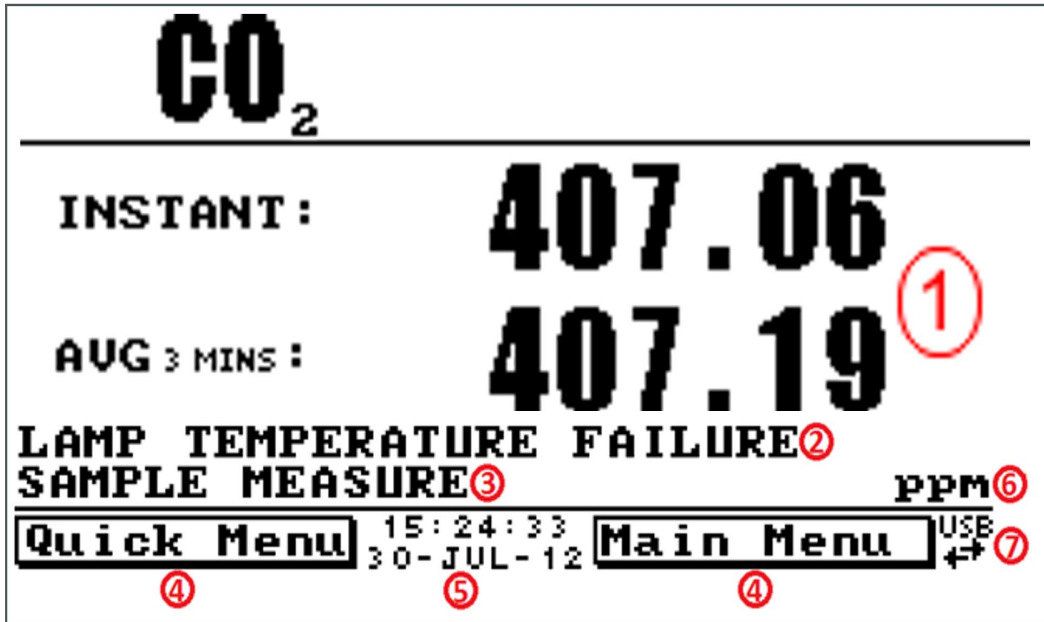

Figure 11 – Home Screen

#### Readings (1)

Displays the concentration being measured in real-time. The display can be configured to show just the instantaneous data or the instantaneous and average data (refer to Section 3.4.8 **Home Screen**).

#### Error/Status (2)

The error/status line provides users with information on any problems the instrument may have. It displays the highest priority error or status condition contained in the **Status Menu** (refer to Section 3.4.4).

#### Instrument Activity (3)

This line shows what function the instrument is currently performing. Generally, it will show three groups of actions: Warm-up, Measurement or Calibration.

#### Selection Buttons (4)

These buttons are used on the home screen to enter one of two menus. The **Quick Menu** (refer to Section 3.4.1) contains all information and features necessary for scheduled maintenance. The **Main Menu** (refer to Section 3.4.2) contains all information and fields available to users and is generally only used during initial set-up and diagnostics.

#### Time and Date (5)

The time and date are displayed in between the menu buttons at the bottom of the screen.

## Concentration Units (6)

The instrument units are displayed in the bottom right hand corner of the display.

## USB Detection (7)

A USB symbol will be displayed in the bottom right corner when the USB memory stick is plugged in (the USB socket is behind the front panel). If the USB symbol is not shown the USB memory stick should be inserted. Underneath, the USB symbol arrows may be displayed which indicates data transfer. The USB memory stick must not be removed whilst the arrows are visible.

**Note:** To safely remove the USB memory stick, navigate to the Quick Menu and use the Safely Remove USB Stick function (refer to Section 3.4.1).

## 3.4 Menus & Screens

The menu system is divided into two sections, the **Quick Menu** and the **Main Menu** selectable from the **Home Screen**. The **Quick Menu** contains all information and operations necessary during scheduled maintenance visits. The **Main Menu** contains all fields that are accessible to users. It provides information on component failures and measurement parameters as well as editable fields and test procedures.

In general, editable parameters are displayed in bold font. Non-editable information is displayed in a thin font. Some parameters may become editable based on the state of the instrument.

For example, the manual calibration type and mode can only be changed when the instrument has finished the warm-up process.

### 3.4.1 Quick Menu

The **Quick Menu** contains all the maintenance tools in one easy to use screen. It allows operators to perform calibrations, check important parameters and review the service history.

<b>Span Calibrate CO2</b>	<p>This field is used to perform a span calibration adjustment and should be only used when a known concentration of span gas is being drawn through the measurement cell and the reading is stable.</p> <p>Activating the span calibrate field for a named gas will open a dialog box. Enter the concentration of the span gas that the instrument is sampling and press <b>Accept</b>.</p>
<b>Event Log</b>	<p>This field enters a screen with a log of all the events that the instrument has performed. These events include errors and warnings. This log is stored on the removable USB memory stick.</p> <p>The log is organised by month. When you enter this screen, you will be prompted to enter the month for which you wish to view events.</p>
<b>Instrument</b>	<p>This field allows the instrument to be set to either <b>Online</b> (normal instrument operation) or <b>In Maintenance</b> (data is flagged as invalid).</p>

<b>Safely Remove USB Stick</b>	Always select this menu item before removing the USB memory stick or select the same menu item from the <b>Service Menu</b> (refer to Section 3.4.13). Failure to do this may cause corruption of the memory stick.
<b>Instrument Gain</b>	This is a multiplication factor which is used to adjust the concentration measurement to the appropriate level (set by performing a <b>Span Calibrate CO2</b> ). This should be recorded after each calibration in the station log book.
<b>Next Service Due</b>	A field that notifies the user when the next instrument service is due. This value is editable in the <b>Next Service Due</b> field of the <b>Advanced Menu</b> (refer to Section 3.4.33). This field is only displayed in the two weeks prior to the date displayed in this field or after the date has occurred.

### 3.4.2 Main Menu

There are six menus on the **Main Menu** screen.

<b>Analyser State Menu</b>	Refer to Section 3.4.3.
<b>General Settings Menu</b>	Refer to Section 3.4.8.
<b>Measurement Settings Menu</b>	Refer to Section 3.4.9.
<b>Calibration Menu</b>	Refer to Section 3.4.10.
<b>Service Menu</b>	Refer to Section 3.4.13.
<b>Communications Menu</b>	Refer to Section 3.4.22.
<b>Trend Display Menu</b>	Refer to Section 3.4.31.

### 3.4.3 Analyser State Menu

#### Main Menu → Analyser State Menu

This displays the status of various parameters that affect instrument measurements.

<b>Status Menu</b>	Refer to Section 3.4.4.
<b>Temperature Menu</b>	Refer to Section 3.4.5.
<b>Pressure &amp; Flow Menu</b>	Refer to Section 3.4.6.
<b>Voltage Menu</b>	Refer to Section 3.4.7.
<b>Model</b>	This field will display the instrument model. (e.g. Serinus 31).
<b>Nominal Range</b>	The range of the Serinus model (e.g. 3000.00 ppm).
<b>Ecotech ID</b>	The Ecotech ID number.
<b>Serial No.</b>	The main controller PCA serial number.
<b>Board Revision</b>	The main controller PCA version.
<b>Firmware Ver.</b>	This field displays the firmware version currently in use on this instrument. This can be important when performing diagnostics and reporting back to

the manufacturer.

<b>Power Failure</b>	This field displays the time and date of the last power failure or when power was disconnected from the instrument.
----------------------	---

### 3.4.4 Status Menu

#### Main Menu → Analyser State Menu → Status Menu

The **Status Menu** presents a list of the current **Pass/Fail** statuses of the main components. During warm-up, the status of some parameters will be a dashed line.

<b>Event Log</b>	This field enters a screen with a log of all the events that the instrument has performed. These events include errors and warnings. This log is stored on the USB memory stick. The log is organised by month. When you enter this screen you will be prompted to enter the month for which you wish to view events.
<b>Show Error List</b>	This field allows the user to display the list of current errors and warnings on the screen.
<b>Next Service Due</b>	This field is visible with the next service due date if the service is due within the next two weeks.
<b>Maintenance Mode</b>	Error if the system is “ <b>In Maintenance</b> ” (refer to Section 3.4.13).
<b>+5V Supply</b>	Pass if the +5 V power supply is within the acceptable range.
<b>+12V Supply</b>	Pass if the +12 V power supply is within the acceptable range.
<b>+Analog Supply</b>	Pass if the analog power supply is within the acceptable range (+12 V).
<b>-Analog Supply</b>	Pass if the analog power supply is within the acceptable range (-12 V).
<b>A2D</b>	Fail only if a problem is detected with the analog to digital conversion.
<b>Cell Temp.</b>	Pass if the cell heater temperature is within $\pm 10\%$ of the heater set point.
<b>Mirror Temp.</b>	Pass if the mirror heater temperature is within $\pm 10\%$ of set point.
<b>Lamp/Source</b>	Fail if the reference voltage is less than 0.5 V and the input pot is over 250, which can be caused by the IR source failing.
<b>Correlation Wheel</b>	Fail if the correlation wheel is not functioning.
<b>Ref Voltage</b>	Checks that the reference voltage is within acceptable limits 3.6 V to 4.4 V.
<b>IR Source</b>	Checks that the IR source voltage is 5 V $\pm 0.5$ V.
<b>System Power</b>	Pass if the system has an adequate electrical supply.
<b>Diagnostic Mode</b>	Error if the electronics are in <b>Diagnostic Mode</b> (refer to Section 3.4.15).
<b>Diagnostic PTF Comp</b>	Error if the <b>Pres/Temp/Flow Comp.</b> is disabled (refer to Section 3.4.14).
<b>Diagnostic Control</b>	Error if the control loop is disabled (refer to Section 3.4.14).
<b>Valve Manual Control</b>	Error if the valve sequencing is disabled (refer to Section 3.4.17).
<b>CO2 Conc V Saturated</b>	Indicates if the voltage of the concentration during measurement is within the limits of the analog to digital converter (-0.26 V to 3.29 V).

<b>Background Conc V Saturated</b>	Indicates if the voltage of the concentration during background measurement is within the limits of the analog to digital converter (-0.26 V to 3.29 V).
<b>Pressure Calibration</b>	Error if the user is performing a pressure calibration.
<b>Flow Calibration</b> [Internal Pump Option]	Error if the user is performing a flow calibration.
<b>CO2 Linearisation</b>	This is only for a factory calibration and should never occur.
<b>Flow Fault</b>	Ok when the instrument has acceptable sample flow based on the difference between cell and ambient pressures. With the internal pump option this fault is monitored by a flow sensor.
<b>Flow Block Temp.</b> [Internal Pump Option]	Pass if the flow block temperature is within 10 % of the heater set point (to keep a constant accurate flow).
<b>Chassis Temperature</b>	Pass if the chassis temperature is within the acceptable limits (0-50 °C).
<b>USB Stick Disconnected</b>	Detects whether a USB memory stick is plugged into the front USB port.
<b>Instrument Warmup</b>	Ok once the instrument is out of warm-up status.
<b>Backgrounds Disabled</b>	Ok if backgrounds is enabled.

### 3.4.5 Temperature Menu

Main Menu → Analyser State Menu → Temperature Menu

<b>Temperature Units</b>	The current temperature units of the instrument ( <b>Celsius, Fahrenheit</b> or <b>Kelvin</b> ).
<b>Set Point (CELL)</b>	The temperature set point of the measurement cell. The factory default is 50 °C.
<b>Set Point (FLOW)</b> [Internal Pump Option]	The temperature set point of the flow block heater. The factory default is 50 °C.
<b>Cell</b>	Displays current temperature of the measurement cell.
<b>Flow Block</b> [Internal Pump Option]	Displays the current temperature of the flow block.
<b>Chassis</b>	Displays the temperature of air inside the chassis, measured on the main controller PCA.
<b>Mirror</b>	Displays the temperature of the end-cap mirror plate on the measurement cell.

### 3.4.6 Pressure & Flow Menu

Main Menu → Analyser State Menu → Pressure & Flow Menu

<b>Pressure Units</b>	Select the units that the pressure will be displayed in ( <b>torr, PSI, mBar, ATM</b> or <b>kPa</b> ).
<b>Ambient</b>	Current ambient pressure.
<b>Cell</b>	Current pressure within the measurement cell.



<b>Flow Units</b>	Select the units that the sample flow will be displayed in ( <b>slpm</b> or <b>L/min</b> ).
<b>Flow Set Point</b> <b>[Internal Pump Option]</b>	The desired sample flow.
<b>Sample Flow</b>	Indicates the gas flow through the sample port of the instrument. The value should be around 1.0 slpm. If there is an error with the sample flow, it will read 0.00 slpm.

### 3.4.7 Voltage Menu

**Main Menu → Analyser State Menu → Voltage Menu**

<b>IR Source</b>	The drive voltage of the IR source 5 V ±0.5 V.
<b>Conc Voltage (RAW)</b>	Voltage from the sensor proportional to the detected signal from the measurement cell. This voltage represents the actual measurement of gas.
<b>Conc Voltage</b>	Displays the detector voltage after PGA scaling.
<b>Ref. Voltage</b>	The reference voltage is a measure of the IR source intensity.
<b>Flow Voltage</b> <b>[Internal Pump Option]</b>	The current voltage measured from the flow block PCA.
<b>Cooler Voltage</b>	Voltage of the peltier cooler within the IR detector (~1.17 V).
<b>+5V Supply</b>	+5 V power supply.
<b>+12V Supply</b>	+12 V power supply.
<b>+Analog Supply</b>	+12 V (primary) power supply. The value should be within ±2 V.
<b>-Analog Supply</b>	-12 V (primary) power supply. The value should be within ±2 V.

### 3.4.8 General Settings Menu

**Main Menu → General Settings Menu**

<b>Decimal Places</b>	Select the number of decimal places (0-5) used for the concentration displayed on the home screen.
<b>Conc. Units</b>	Sets the concentration units ( <b>ppm</b> , <b>ppb</b> , <b>ppt</b> , <b>mg/m3</b> , <b>µg/m3</b> or <b>ng/m3</b> ).
<b>Conversion Factor</b> <b>[Gravimetric Units]</b>	This option only appears if concentration units are set to gravimetric ( <b>mg/m3</b> , <b>µg/m3</b> or <b>ng/m3</b> ). Select either <b>0°C</b> , <b>20°C</b> or <b>25°C</b> . This sets the standard temperature used from conversion for measured volumetric values.
<b>Temperature Units</b>	Select the units that temperature will be displayed in ( <b>Celsius</b> , <b>Fahrenheit</b> or <b>Kelvin</b> ).
<b>Pressure Units</b>	Select the units that the pressure will be displayed in ( <b>torr</b> , <b>PSI</b> , <b>mBar</b> , <b>ATM</b> or <b>kPa</b> ).
<b>Flow Units</b>	Select the units that the sample flow will be displayed in ( <b>slpm</b> or <b>L/min</b> ).
<b>Date</b>	Displays the current date and allows users to edit if required.
<b>Time</b>	Displays the current time and allows users to edit if required.

<b>Backlight</b>	Select the length of time the screen and keypad backlight remain on after a button press. The setting <b>Always Off</b> means the backlight never turns on; the setting <b>Always On</b> means the backlight never turns off.
<b>Home Screen</b>	This field allows the user to display concentrations on the <b>Home Screen</b> in two formats. The first is <b>Inst. only</b> which displays only the instantaneous concentration reading, the second is <b>Inst &amp; Avg</b> which displays both instantaneous and average concentration on the <b>Home Screen</b> . The average is measured over the time period set in <b>Measurement Settings Menu</b> (refer to Section 3.4.9).
<b>Char 0 has Slash</b>	When enabled, the instrument will display the zero character with a slash (0) to differentiate it from a capital 'O'.

### 3.4.9 Measurement Settings Menu

#### Main Menu → Measurement Settings Menu

<b>Average Period</b>	Set the time period over which the average will be calculated: Minutes ( <b>1, 2, 3, 4, 5, 6, 10, 12, 15, 20</b> or <b>30</b> ) or hours ( <b>1, 2, 4, 6, 8, 12</b> or <b>24</b> ) or rolling hourly averages over the last ( <b>4</b> or <b>8</b> ) hours.
<b>Cal. Average Period</b>	When Enabled can set the time period over which the calibration average will be calculated when the system is in Cal. Mode SPAN or ZERO: Minutes ( <b>1, 2, 3, 4, 5, 6, 10, 12, 15, 20</b> or <b>30</b> ) or hours ( <b>1, 2, 4, 6, 8, 12</b> or <b>24</b> ) or rolling hourly averages over the last ( <b>4</b> or <b>8</b> ) hours. Default is Disabled.
<b>Min. Data Capture</b>	Controls how much of the previous time period needs to be included before the average yields a number.  The default is 0 %, which reflects past behaviour of the instrument: turning on a machine with 15 minute averaging and a setting of 0 % at 1:01 or 1:14 would produce ##### until 1:15 (because at 1:15, there was at least 1 valid measurement to construct the average from). Setting 100 % would mean the value stayed ##### until 1:30 (because there needs to be a complete 15 minutes worth of measurements to construct the average from).
<b>Filter Type</b>	Sets the type of digital filter used ( <b>None, Kalman, 10 sec, 30 sec, 60 sec, 90 sec, 300 sec</b> or <b>Rolling</b> ).  The Kalman filter is the factory default and gives the best overall performance for this instrument.
<b>Rolling Size [Rolling Filter]</b>	Sets the number of measurements included in the rolling average. Only available if the <b>Filter Type</b> is set to <b>Rolling</b> .
<b>Backgrounds</b>	The default setting is enabled. When enabled it allows the user to edit the background interval via the following fields <b>Time, Repeat</b> and <b>Units</b> .  When any of the backgrounds fields are edited the instrument will automatically calculate the date and time the next background is due to run and display under each relevant field.
<b>Date [Backgrounds]</b>	Displays the date that the next background is due to run.
<b>Time [Backgrounds]</b>	Edit and display the time that the next background will run. The time is set using a 24 hour clock.

<b>Repeat</b> [Backgrounds]	Defines an interval value for the repeat of the background based on the <b>Units</b> selected. This field indicates the delay period; once the specified amount of time has lapsed the background will automatically run again. The user can edit this field but some restriction apply depending on the <b>Units</b> selected. Default is "1".
<b>Units</b> [Backgrounds]	This is where the user can define the type of units for the <b>Repeat</b> delay period. For example: A <b>Repeat</b> of "1" and <b>Units</b> of "Days" means that a calibration will automatically run every day at the defined time. Default is "Days"

### 3.4.10 Calibration Menu

#### Main Menu → Calibration Menu

Calibrating the instrument should be done with care (refer to Section 5 before using these menus).

<b>Cal. Type</b>	Depending on the selection in this field, a number of extra menu items will be displayed. These are separately documented in <b>Manual Mode</b> (refer to Section 3.4.10.1) and <b>Timed Mode</b> (refer to Section 3.4.10.2). Select the <b>Cal. Type</b> field and select either <b>Timed</b> or <b>Manual</b> . <b>Timed</b> mode is an automatic calibration controlled by the: <ul style="list-style-type: none"> <li>▪ Interval between cycles</li> <li>▪ Length of each calibration cycle</li> <li>▪ Time when the calibration will begin</li> <li>▪ Check only or automatic compensation</li> </ul> <b>Manual</b> mode allows you to choose the type of calibration you wish to perform and will open the appropriate valves in preparation for the user to perform a manual calibration. The setup used will depend on the <b>Cal. Mode</b> selected. Manual mode is set as default.
<b>Zero Source</b>	Select whether the instrument will sample from the (external) calibration port or from the (internal) background air port when zero air is requested.
<b>Cycle Time</b>	The duration of each <b>Cal. Mode</b> (span and zero) when performing <b>Cycle Mode</b> (refer to Section 3.4.10.1) or <b>Cal. Type</b> is set to <b>Timed</b> . (refer to Section 3.4.10.2)
<b>Span Calibrate CO2</b>	This field is used to perform a span calibration and should be only used when a known concentration of span gas is running through the measurement cell and the reading is stable. Activating the span calibrate field for a named gas will open a dialog box. Enter the concentration of the span gas that the instrument is sampling and press <b>Accept</b> .
<b>Zero Calibrate CO2</b>	This command is used to correct the zero calibration setting. This option should be used only when zero air is running through the measurement cell (refer to Section 5.5 before using this command).
<b>Manual Background</b>	Immediately perform a background.
<b>Pressure Calibration Menu</b>	Refer to Section 3.4.11.
<b>Flow Calibration Menu</b> [Internal Pump Option]	Refer to Section 3.4.12.
<b>Pressure CO2</b>	This field displays the cell pressure measured during the last calibration.

<b>Temperature</b>	Cell temperature when the last span calibration was performed.
--------------------	--

### 3.4.10.1 Manual Mode

These items appear in the **Calibration Menu** when **Cal. Type** is set to **Manual**.

<b>Cal. Mode</b>	<p>When calibration type is set to <b>Manual</b> the instruments operational mode can be chosen from the following:</p> <ul style="list-style-type: none"> <li>▪ <b>Measure:</b> Is the normal measurement through the sample port.</li> <li>▪ <b>Zero:</b> This mode will take air depending on the zero source selected. External will draw air through the calibration port and Internal will draw air from the background air port so that a zero calibration can be performed. Data is flagged as zero data.</li> <li>▪ <b>Span:</b> This mode will take air through the calibration port so that a span calibration can be performed. Data is flagged as span data.</li> <li>▪ <b>Cycle:</b> Performs a zero and a span calibration mode and returns to measure mode. The length of time spent measuring each calibration mode is set in <b>Cycle Time</b> (refer to Section 3.4.10).</li> </ul> <p>While the instrument is still in the warm-up period (refer to Section 3.1) the <b>Cal. Mode</b> cannot be changed from <b>Measure</b> mode.</p>
------------------	---

### 3.4.10.2 Timed Mode

These items appear in the **Calibration Menu** when **Cal. Type** is set to **Timed**.

<b>Date</b>	Enter the date for the next calibration to start.
<b>Time</b>	Enter the time that calibration will be performed. The time is set using a 24 hour clock.
<b>Repeat</b>	The calibration will automatically run again after the specified amount of time. This field specifies the delay period (from 1 to 20,000 units, as specified below).
<b>Units</b>	This is where the user can define the type of units for the <b>Repeat</b> delay period. For example: A <b>Repeat</b> of “3” and units of “ <b>Days</b> ” means that a calibration will automatically be performed every three days.
<b>Span Compensation</b>	<p>When <b>Enabled</b> the instrument will automatically perform a <b>Span Calibrate CO2</b> at the end of the <b>Cycle Time</b> and adjust the gain based on the <b>Span Level</b>.</p> <p>When <b>Disabled</b> it will do a precision check only, no adjustment is made.</p> <p>Timed calibration with span compensation enabled does not fulfil U.S. EPA approval or EN certification.</p>
<b>Span Level</b>	Enter the concentration of span gas expected. Used when the <b>Span Compensation</b> is <b>Enabled</b> .

### 3.4.11 Pressure Calibration Menu

**Main Menu → Calibration Menu → Pressure Calibration Menu**

Entering this menu will set the valves to the pressure calibration configuration; leaving the menu will restore the valves to normal operation (refer to Section 5.2).

<b>Vacuum Set Pt.</b>	The zero point for the calibration. Activating this item will open a dialog box of instructions.
<b>Ambient Set Pt.</b>	The high point for the calibration. Activating this item will open a dialog box of instructions.
<b>Pressure Units</b>	Select the units that the pressure will be displayed in ( <b>torr, PSI, mBar, ATM</b> or <b>kPa</b> ).
<b>Ambient</b>	The current ambient pressure.
	The current ambient pressure displayed as a raw voltage.
<b>Cell</b>	The current pressure in the measurement cell.
	The current measurement cell pressure displayed as a raw voltage.
<b>Vacuum Cal Mode</b>	When turned on the valves will be set in a vacuum calibration state. This can be used to verify the calibration worked.
<b>Ambient Cal Mode</b>	When turned on the valves will be set in an ambient calibration state. This can be used to verify the calibration worked.

### 3.4.12 Flow Calibration Menu (Option)

#### Main Menu → Calibration Menu → Flow Calibration Menu

This menu only appears when the internal pump option is installed. Please refer to Section 5.9 for the calibration procedure. Setting the **Flow Control** to **MANUAL** will automatically disable the valve sequencing ready for flow calibration.

<b>Flow Set Point</b>	The desired sample flow target.
<b>Cell</b>	The current pressure in the measurement cell.
<b>Cal. Point</b>	The flow at which the last flow calibration was performed. If <b>Flow Control</b> is set to <b>MANUAL</b> and <b>Internal Pump</b> is <b>ON</b> , this field can be edited to calibrate the current flow against a reference. Calibration must be done at or near the flow set point for best results (refer to Section 5.9).
<b>Cal. Zero</b>	If <b>Flow Control</b> is set to <b>MANUAL</b> and <b>Internal Pump</b> is <b>OFF</b> , activating this command will calibrate the flow sensor zero point (refer to Section 5.9).
<b>Sample Flow</b>	Current sample flow through the instrument. This is only accurate when reading close to the flow calibration point.
<b>Internal Pump</b>	This field allows the internal pump to be turned on or off. This field is only editable when the <b>Flow Control</b> field is set to <b>MANUAL</b> .
<b>Pump Control</b>	Set to <b>MANUAL</b> to disable the automatic flow control. <b>AUTO</b> allows the flow PID to modify the pump coarse and fine settings. <b>START</b> will transition to <b>AUTO</b> after one second.
<b>Coarse</b>	Internal pump speed control ( <b>Coarse</b> ). This field is only editable when the <b>Flow Control</b> field is set to <b>MANUAL</b> .
<b>Fine</b>	Internal Pump speed control ( <b>Fine</b> ). This field is only editable when the <b>Flow Control</b> field is set to <b>MANUAL</b> .
<b>Valve Menu</b>	Refer to Section 3.4.17.

### 3.4.13 Service Menu

#### Main Menu → Service Menu

Diagnostics Menu	Refer to Section 3.4.14.
Calculation Factors Menu	Refer to Section 3.4.21.
Load Auto-Backup Config.	Loads the auto-backup configuration file. The configuration is automatically backed up every night at midnight.
Load Configuration	Loads a user selectable configuration file from the USB memory stick.
Save Configuration	Saves all of the EEPROM-stored user-selectable instrument configurations to the USB memory stick (calibration and communication settings, units, instrument gain, etc.). If there are problems with the instrument use this function to save settings to the USB memory stick and send this file (together with the parameter list save) to your supplier with your service enquiry.
Save Parameter List	Saves a text file of various parameters and calculation factors. If you have problems with the instrument use this function to save settings to the USB memory stick and send this file (together with the configuration save) to your supplier with your service enquiry.
Instrument	This field allows the instrument to be set to either <b>Online</b> (normal instrument operation) or <b>In Maintenance</b> (data is flagged as invalid).
Next Service Due	Displays when the next scheduled service is due.
Safely Remove USB Stick	This command must be activated to safely remove the USB memory stick.
System Restart	Activating this will restart the instrument.

### 3.4.14 Diagnostics Menu

#### Main Menu → Service Menu → Diagnostics Menu

Digital Pots Menu	Refer to Section 3.4.15.
Internal Pump Menu [Internal Pump Option]	Refer to Section 3.4.16.
Valve Menu	Refer to Section 3.4.17.
Tests Menu	Refer to Section 3.4.18.
Pres/Temp/Flow Comp.	<b>On</b> (default): Is used to compensate instrument measurements for environmental fluctuations that might affect readings (pressure, temperature and flow). <b>Off</b> : Is used only when running diagnostics.
Control Loop	<b>Enabled</b> (default): Allows the instrument to automatically adjust digital pots and other outputs. <b>Disabled</b> : Prevents the instrument from changing most outputs so the service technician can manually control them.

### 3.4.15 Digital Pots Menu

**Main Menu → Service Menu → Diagnostics Menu → Digital Pots Menu**

Digital pots are electronically controlled digital potentiometers used for adjustments to operations of the instrument. Each of the digital pots can go from 0-255. This menu should be accessed only during diagnostics.

Unless the **Control Loop** is **Disabled** (refer to Section 3.4.14), changes to the pots may be modified by the instrument. This is intentional; some diagnostics are best done with instrument feedback and some are best done without.

<b>PGA Gain</b>	1-128	Displays the gain of the PGA.
<b>Input Pot</b>	155-190	Reduces the raw signal to measurable level.
<b>Conc. Voltage (RAW)</b>	0-3.1	The concentration voltage measured by the analog to digital converter.
<b>Conc. Voltage</b>	0-3.1	The concentration voltage after adjustment for the PGA gain factor.
<b>Meas. Zero Pot (COARSE)</b>	125-225	Electronic zero for the measure channel.
<b>Meas. Zero Pot (FINE)</b>	0-255	Electronic zero for the measure channel.
<b>Ref. Voltage</b>	3.5-4.5	The reference voltage of the detector.
<b>Source Pot</b>	227	Adjusts the drive current for the IR source.
<b>IR Source</b>	4.9-5.1	The voltage driving the IR source.
<b>Cooler Pot</b>	45	Adjusts the drive current for the cooler.
<b>Cooler Voltage</b>	1.15-1.20	The voltage being applied to the cooler.
<b>Test Meas. Pot</b>	0	This Digital Pot is used for diagnostics only. When in the <b>Electrical</b> or <b>Preamp Diagnostic Mode</b> , this Digital pot should be adjusted from 0 to 255. This will produce a change in the concentration voltage as well as the indicated gas concentration.
<b>Test Ref. Pot</b>	0	This Digital Pot is used for diagnostics only. When in the <b>Electrical</b> or <b>Preamp Diagnostic Mode</b> , this Digital Pot should be adjusted from 0 to 255. This will produce a change in the reference voltage.

<b>Diagnostic Mode</b>	<b>Operate</b>	<ul style="list-style-type: none"> <li>▪ <b>Operate</b> (default): Puts the instrument in normal operation mode.</li> <li>▪ <b>Electrical</b>: Injects an artificial test signal into the electronic processing circuitry on the main controller PCA to verify that the circuitry is operating correctly. When in this <b>Diagnostic Mode</b>, adjust the <b>Test Meas Pot</b> from 0 to 255. This will produce a change in the concentration voltage as well as the indicated gas concentration. Adjust the <b>Test Ref Pot</b> from 0 to 255 to produce a change in the reference voltage.</li> <li>▪ <b>Preamp</b>: Injects an artificial test signal into the Preamplifier mounted on the <b>Measurement Cell</b> to verify that the Preamplifier, cabling and electronic circuitry on the main controller PCA is operating correctly. When in this <b>Diagnostic Mode</b>, adjust the <b>Test Meas Pot</b> from 0 to 255. This will produce a change in the concentration voltage as well as the indicated gas concentration. Adjust the <b>Test Ref Pot</b> from 0 to 255 to produce a change in the reference voltage.</li> </ul>
------------------------	----------------	--

### 3.4.16 Internal Pump Menu (Option)

**Main Menu → Service Menu → Diagnostics Menu → Internal Pump Menu**

This menu only appears when the internal pump option is installed. Setting the Flow Control to MANUAL will automatically disable the valve sequencing.

<b>Flow Set Point</b>	The desired sample flow target.
<b>Cell</b>	The current pressure in the measurement cell.
<b>Sample Flow</b>	Current gas flow. This is only accurate when reading close to the flow calibration point.
<b>Internal Pump</b>	This field allows the internal pump to be turned on or off. This field is only editable when the <b>Flow Control</b> field is set to <b>MANUAL</b> .
<b>Pump Control</b>	Set to <b>MANUAL</b> to disable the automatic flow control. <b>AUTO</b> allows the flow PID to modify the pump coarse and fine settings. <b>START</b> will transition to <b>AUTO</b> after one second.
<b>Coarse</b>	Internal pump speed control ( <b>Coarse</b> ). This field is only editable when the <b>Flow Control</b> field is set to <b>MANUAL</b> .
<b>Fine</b>	Internal Pump speed control ( <b>Fine</b> ). This field is only editable when the <b>Flow Control</b> field is set to <b>MANUAL</b> .

### 3.4.17 Valve Menu

**Main Menu → Service Menu → Diagnostics Menu → Valve Menu**

The **Valve Menu** allows the user to observe the instrument controlled switching of the valves. If the valve is On it means the valve is energised. When a three way valve is in the On state it will now be in the NC (normally closed) position as shown in the plumbing schematic. When the valve sequencing is disabled the user has the ability to turn the valve Off and On manually. It is recommended that the valve menu be used by a trained technician following the plumbing schematic (refer to Section 9.5).



**Note:** When interpreting the information below regarding the flow path through the valve note that (NC = Normally Closed), (NO = Normally Open) and (C = Common).

<b>Valve Sequencing</b>	When <b>Enabled</b> the valves will turn On and Off under the instruments control (even if you have manually turned <b>Off</b> or <b>On</b> a valve). When <b>Disabled</b> the valves will change only in response to a user's action.
<b>Sample/Cal</b>	Indicates if the <b>Sample/Cal</b> valve on the <b>Calibration Valve Manifold</b> is <b>Off</b> or <b>On</b> . This will determine the port the instrument draws its sample from. <b>Off</b> = Flow from NO to C (drawing sample from the <b>Sample Port</b> ). <b>On</b> = Flow from NC to C (drawing sample from the <b>Calibration Port</b> ).
<b>Internal Zero/Cal</b>	Indicates if the <b>Internal Zero/Cal</b> valve on the <b>Calibration Valve Manifold</b> is <b>Off</b> or <b>On</b> . This will determine the port the instrument draws its sample from, when selecting <b>Cal. Mode → Zero</b> . <b>Off</b> = Flow from NO to C (drawing sample from the <b>BGnd Air Port</b> ). <b>On</b> = Flow from NC to C (drawing sample from the <b>Calibration Port</b> ).
<b>Pressurised Zero [optional]</b>	Indicates if the optional pressurised zero port valve is <b>Off</b> or <b>On</b> (refer to Section 8.6).
<b>Pressurised Span [optional]</b>	Indicates if the optional pressurised span port valve is <b>Off</b> or <b>On</b> (refer to Section 8.6).

### 3.4.18 Tests Menu

Main Menu → Service Menu → Diagnostics Menu → Tests Menu

<b>Screen Test</b>	Performs a screen test by drawing lines and images on the screen so that the operator can determine if there are any faults in the screen. Press a keypad key to step through the test. The up and down arrow keys will adjust the contrast.
<b>Digital Input Test Menu</b>	Refer to Section 3.4.19.
<b>Digital Output Test Menu</b>	Refer to Section 3.4.20.

### 3.4.19 Digital Input Test Menu

Main Menu → Service Menu → Diagnostics Menu → Tests Menu → Digital Input Test Menu

<b>Input 0..7 (PIN n)</b>	Displays the status of the 0-7 digital input pins and their corresponding pin out on the external 25 Pin I/O socket (refer to Figure 21). Value will be 0 or 1.
---------------------------	---

**Note:** Entering the **Digital Inputs Menu** will temporarily disable all digital and analog input/outputs. This will affect logging via these outputs. Exiting the menu restores automatic control.

### 3.4.20 Digital Output Test Menu

Main Menu → Service Menu → Diagnostics Menu → Tests Menu → Digital Output Test Menu

<b>Automated Test</b>	When started will automatically step through each output, turning it On and Off.
<b>Output 0..7 (PIN n)</b>	Displays the state ( <b>On</b> or <b>Off</b> ) of the output pin and their corresponding pin out on the external 25 Pin I/O socket (refer to Figure 21), and allows the user to manually set the state.

**Note:** Entering the **Digital Outputs Menu** will temporarily disable all digital and analog input/outputs. This will affect logging via these outputs. Exiting the menu restores automatic control.

### 3.4.21 Calculation Factors Menu

Main Menu → Service Menu → Calculation Factors Menu

The **Calculation Factors Menu** provides the user with the values used to calculate different aspects of measurement and calibration.

<b>Instrument Gain</b>	A multiplication factor used to adjust the concentration measurement to the appropriate level (set at calibration).
<b>Zero Offset CO2</b>	This field displays the offset created from a zero calibration. This is the concentration measured from zero air and is subtracted from all readings.
<b>Background</b>	The correction factor calculated from the background cycle (used to eliminate background interferences).
<b>PTF Correction CO2</b>	Displays the correction factor applied to the concentration measurement. This correction is for changes in pressure, temperature and flows since the last calibration.
<b>Noise</b>	<p>The standard deviation of the concentration. The calculation is as follows:</p> <ul style="list-style-type: none"> <li>▪ Take a concentration value once every two minutes.</li> <li>▪ Store 25 of these samples in a first in, last out buffer.</li> <li>▪ Every two minutes, calculate the standard deviation of the current 25 samples. This is a microprocessor-generated field and cannot be set by the user.</li> </ul> <p>This reading is only valid if zero air or a steady concentration of span gas has been supplied to the instrument for at least one hour.</p>
<b>Undiluted CO2</b>	Displays the actual reading on the analyser before the dilution ratio is applied. If the Dilution ratio is 1 both undiluted CO2 and diluted CO2 field will be the same value.

<b>Dilution Ratio</b>	<p>Entering a value here will multiply the displayed and recorded measurements by the dilution amount. For example, if the instrument is measuring a source where the average concentration is above the upper limit of the measurement range, a dilution probe with a fixed ratio dilution ratio can be used to reduce the level measured by the instrument, so for a 4:1 dilution ratio, enter a value of 4.</p> <p>Enter the ratio here so the instrument can display the correct value on the instrument.</p> <p>The default value is 1.00 (this indicates no dilution is applied).</p>
<b>Diluted CO2</b>	<p>Displays the current reading on the analyser after the dilution ratio is applied. If the Dilution ratio is 1 both undiluted CO2 and diluted CO2 field will be the same value.</p>

### 3.4.22 Communications Menu

#### Main Menu → Communications Menu

Configures how the instrument communicates with external instrumentation and data loggers.

<b>Data Logging Menu</b>	Refer to Section 3.4.23.
<b>Serial Communication Menu</b>	Refer to Section 3.4.24.
<b>Analog Input Menu</b>	Refer to Section 3.4.25.
<b>Analog Output Menu</b>	Refer to Section 3.4.26.
<b>Digital Input Menu</b>	Refer to Section 3.4.27.
<b>Digital Output Menu</b>	Refer to Section 3.4.28.
<b>Network Menu [optional]</b>	Refer to Section 3.4.29.
<b>Bluetooth Menu</b>	Refer to Section 3.4.30.

### 3.4.23 Data Logging Menu

#### Main Menu → Communications Menu → Data Logging Menu

When editing the numeric or text menus, the “-” key will delete the current parameter and move the others up to take its place; the “+” key will insert a parameter at the current location and move the ones below it down. The internal logger can log a maximum of 12 parameters.

<b>Data Log Interval</b>	<p>Displays the interval at which the data is saved to the USB memory stick. Selecting a <b>1 sec</b> interval may result in occasional measurements not being logged or slow response to serial commands.</p>
<b>Cal. Log Interval</b>	<p>When enabled displays the interval at which the data is saved to the USB memory stick for the calibration time period. This occurs when the system is in Cal. Mode SPAN or ZERO. Selecting a <b>1 sec</b> interval may result in occasional measurements not being logged or slow response to serial commands. Seconds (<b>1, 2, 5, 10, 15, 30</b>) or Minutes (<b>1, 2, 3, 5, 10, 15, 20 or 30</b>) or hours (<b>1, 2, 4, 6, 8, 12 or 24</b>). Default is Disabled.</p>
<b>Data Log Setup –Numeric</b>	<p>Numeric list of the parameters logged. This is a quicker way to enter parameters (for a list of parameters refer to Table 21).</p>

**Data Log Setup –Text**                      Select the list of logged parameters by name.

### 3.4.24      **Serial Communication Menu**

**Main Menu → Communications Menu → Serial Communication Menu**

<b>Serial ID</b>	This is the ID of the instrument when using <b>multidrop</b> RS232 communications. This ID can be changed to support multiple instruments on the same RS232 cable.
<b>Bayern-Hessen Serial ID</b> [Bayern-Hessen Protocol]	This is the Bayern-Hessen ID used by the Bayern-Hessen Protocol.
<b>CO2 ID</b> [Bayern-Hessen Protocol]	This is the ID of the CO2 gas used by the Bayern-Hessen Protocol.
<b>Service port (RS232 #1)</b> <b>Multidrop port (RS232 #2)</b>	The port parameters below are repeated for each serial port.
<b>Serial Delay</b>	Some older communication systems require a delay before the instrument responds to a serial command. The number of milliseconds of delay required (0-1000). The default is 0, meaning the instrument responds as quickly as possible to any serial request.
<b>Baudrate</b>	Sets the baud rate for this serial port ( <b>1200, 2400, 4800, 9600, 14400, 19200, 38400</b> or <b>115200</b> ).
<b>Protocol</b>	Sets the protocol used for this serial port ( <b>Advanced, ModBus, EC9800</b> or <b>Bayern-Hessen</b> ). This must be set to <b>Advanced</b> for Ecotech supplied software.
<b>Endian</b> [Modbus Protocol]	Select <b>Little</b> or <b>Big</b> endian mode for ModBus protocol.

### 3.4.25      **Analog Input Menu**

**Main Menu → Communications Menu → Analog Input Menu**

The Serinus supports three analog inputs from the 25 pin I/O connector. Each input is a 0 to 5 volt CAT 1 input that can be scaled and logged to the USB memory stick or accessed remotely as parameters 199 to 201.



**CAUTION**

Exceeding these voltages can permanently damage the instrument and void the warranty.

<b>Input 1/2/3</b>	The sections below are repeated for each analog input.
<b>Multiplier</b>	The input voltage will be multiplied by this number. For example, if a sensor has a 0-5 V output for a temperature of -40 °C to 60 °C, the multiplier would be $(60 - (-40)) / 5 = 20$ .
<b>Offset</b>	This value will be added to the above calculation. Continuing the example in the multiplier description, the offset should be set to -40, so that a voltage of 0 V will be recorded as -40 °C.

<b>Reading</b>	The current reading from the analog input, after the multiplier and offset are applied. This is the value that is logged or reported as parameter 199 to 201.
----------------	---

### 3.4.26 Analog Output Menu

**Main Menu → Communications Menu → Analog Output Menu**

<b>Output Mode</b>	The analog output can be set to be either <b>Current</b> or <b>Voltage</b> . Different fields will be displayed depending on which analog output type is selected.
<b>Channel 0/1/2</b>	Channel 0 as default will be setup to be Parameter 50, which is CO2 instantaneous reading. All three Channels can be user defined to any of the available parameters (for a list of parameters refer to Table 22). All the labels below are repeated for each Channel.
<b>Name</b>	Text list of the parameter defined to output through the analog output (for a list of parameters refer to Table 22).
<b>Parameter</b>	Numeric list of the parameter defined to output through the analog output. This is a quicker way to enter parameters (for a list of parameters refer to Table 22).
<b>Min Range</b>	Sets the lower range limit (in concentration units). This is the value at which the analog output should be at its minimum. For example, 4 mA for a 4 to 20 mA current output.
<b>Max Range</b>	Sets the upper range limit (in concentration units). This value can be edited but cannot exceed the <b>Over Range</b> value. This is the value at which the analog output should be at its maximum. For example, 20 mA for a current output.
<b>Over-Ranging</b>	Set to Enabled or Disabled to turn the over-ranging feature on or off.
<b>Over-Range [Over-Ranging Enabled]</b>	This field is only visible when <b>Over-Ranging</b> is set to <b>Enabled</b> . Set to the desired over range value. This value cannot be set below the <b>Range</b> value. This is the alternate scale that is used for the analog output when over-ranging is active and enabled. When 90 % of the standard range is reached, this over range is automatically entered. When 80 % of the original range is reached, it returns to the original range.
<b>Hold for Cal.</b>	When <b>Enabled</b> , putting the instrument into any calibration state other than MEASURE will cause it to continue reporting the last reported value.

#### 3.4.26.1 Analog Output Menu - Voltage

**Main Menu → Communications Menu → Analog Output Menu**

These items appear when **Output Mode** is set to **Voltage**.

<b>Voltage Offset</b>	Choices are <b>0 V</b> , <b>0.25 V</b> or <b>0.5 V</b> . This sets the voltage for a reading of 0. Since the output cannot go negative, this offset can be used to record negative readings.
<b>0.5V Calibration</b>	Enables the user to calibrate the analog voltage output at a low point. Edit the value against a reference volt meter until the connected equipment reads 0.5 V (refer to Section 4.4.1.1).

<b>5.0V Calibration</b>	Enables the user to calibrate the voltage output at a full scale point (5 V). Edit the value against a reference volt meter until the connected equipment reads 5 V (refer to Section 4.4.1.1).
-------------------------	---

### 3.4.26.2 Analog Output Menu - Current

**Main Menu → Communications Menu → Analog Output Menu**

These items appear when **Output Mode** is set to **Current**.

<b>Current Range</b>	Enables the user to set desired current ranges. The user's choices are <b>0-20 mA</b> , <b>2-20 mA</b> or <b>4-20 mA</b> .
<b>4mA Calibration</b>	Enables the user to calibrate the current output at a low point. Edit the value against a reference amp meter until the connected equipment reads 4 mA (refer to Section 4.4.1.2).
<b>20mA Calibration</b>	Enables the user to calibrate the current output at a full scale point (20 mA). Edit the value against a reference amp meter until the connected equipment reads 20 mA (refer to Section 4.4.1.2).

### 3.4.27 Digital Input Menu

**Main Menu → Communications Menu → Digital Input Menu**

This menu is used to remotely trigger zero and span calibrations. This is done by assigning the eight digital inputs with one of the following commands.

<b>DI N (Pin X)</b>	<p>Associates an action with a digital input. There are eight digital inputs (the pin numbers are for the 25 pin connector). Each one can have one of the following associated actions, triggered when the corresponding digital input goes to the <b>Active</b> state:</p> <ul style="list-style-type: none"> <li>▪ <b>Disabled:</b> No action (this digital input does nothing).</li> <li>▪ <b>Do Span:</b> Used to perform a span precision check. When activated the instrument sets the <b>Cal. Mode</b> to <b>Span</b> (refer to Section 3.4.10.1).</li> <li>▪ <b>Do Zero:</b> Used to perform a zero precision check. When activated the instrument sets the <b>Cal. Mode</b> to <b>Zero</b> (refer to Section 3.4.10.1).</li> </ul>
<b>Active</b>	Each pin can be set to be active <b>High</b> or <b>Low</b> . Active High means that the event will be triggered when the line is pulled to 5 V. Active Low means that the event will be triggered when the line is pulled to 0 V.

### Example

Here is a typical configuration between an instrument and either a data logger or calibrator (master device):

1. Set the jumper JP1 to 5 V position (refer to Section 4.4.3).
2. Connect one of the master devices digital output signals to pin 18 and the ground signal to pin 5 of the instrument's analog/digital 25 pin female connector (refer to Figure 21).
3. Program master device to output 0 volts to pin 18 when a span is desired.
4. In the instrument's **Digital Input Menu** assign **DI 0 → Do Span - Accept**.

- The same procedure can be followed to also activate zero calibrations. Pin 6 of the instrument's analog/digital 25 pin female connector can be connected to one of the other master devices digital outputs and the instrument can be set so **DI 1** is assigned to **Do Zero**.

### 3.4.28 Digital Output Menu

**Main Menu → Communications Menu → Digital Output Menu**

This allows the instrument to trigger external alarms in response to certain events. There are eight different pins available, which will be set high during an associated event:

<b>DO N (Pin X)</b>	Associates a state with a digital output. There are eight digital outputs (the pin numbers are for the 25 pin connector). Each one can have one of the associated states listed in Table 4. The pin will be driven to the active state while the instrument state is true.
<b>Active</b>	Each pin can be set to be active <b>High</b> or <b>Low</b> . Active High means that the pin will be pulled to 5 V when the associated event occurs. Active Low means the pin will be pulled to 0 V when the associated event occurs.

**Table 4 – Digital Output States**

Digital Output State	Description
Disabled	No state (this state is never <b>Active</b> ).
Pwr Supply Fail	Power supply fault.
A2D Fail	Analog to digital fault.
Corr. Wheel Fail	Correlation wheel fault.
Flow Fail	Sample flow fault.
Cell Heat Fail	Cell heater fault.
Conv. Heater Fail	Converter heater fault.
Flow Heat Fail	Flow block heater fault.
Mirror Heat Fail	Mirror heater fault.
Lamp Heat Fail	Lamp heater fault.
Chassis Tmp Fail	Chassis temperature fault.
USB Disconnected	The USB memory stick is disconnected.
Background	Performing a background.
Span	Performing a span check.
Zero	Performing a zero check.
System Fault	Any system fault (the red light is on).
Maintenance Mode	User has activated maintenance mode.
Over Range AO 0	Over range for the analog output when channel 0 is active.
Over Range AO 1	Over range for the analog output when channel 1 is active.

Digital Output State	Description
Over Range AO 2	Over range for the analog output when channel 2 is active.

### 3.4.29 Network Menu (Option)

Main Menu → Communications Menu → Network Menu

The **Network Menu** only appears when the **Network Port** is enabled in the **Hardware Menu** (refer to Section 3.4.34). The **Network Menu** allows the user to view or set the IP Address, Netmask and Gateway if the optional network port is installed.

<b>Start-up Mode</b>	<p>The following modes are available:</p> <ul style="list-style-type: none"> <li>▪ <b>Normal:</b> In this mode nothing is done with the network port during boot-up. It is assumed to be configured correctly or unused.</li> <li>▪ <b>Read IP:</b> This mode interrogates the network port for its IP address. The menu will display the network address after boot-up.</li> <li>▪ <b>Set IP:</b> The user may enter an IP address, Netmask and Gateway address (following the usual rules for formatting these addresses). At this time the instrument does not validate the correctness of these entries. When you cycle power, the instrument will first instruct the network port on its new address. It will switch to <b>Read IP</b> mode and read back the address it just set so the user may verify it in the menu.</li> <li>▪ <b>Set DHCP:</b> This sets the network port into DHCP mode, allowing the network to assign the instrument an IP address.</li> </ul>
<b>IP Address</b> [Read IP or Set IP Start-up Mode]	This is the current IP address of the instrument.
<b>Netmask</b> [Read IP or Set IP Start-up Mode]	This is the subnet mask of the network the instrument is connected to.
<b>Gateway</b> [Read IP or Set IP Start-up Mode]	This is the IP address of the router to access addresses not on the same subnet.
<b>ID</b> [Set DHCP Start-up Mode]	In this mode the instrument will ask for its network parameters from a DHCP server on your network. This device will appear on the network as the ID setup in this field, Default identity is SerinusNone.
<b>Protocol</b>	Sets the protocol used for the network port ( <b>Advanced, ModBus, EC9800</b> or <b>Bayern-Hessen</b> ). This must be set to <b>Advanced</b> for Ecotech supplied software.
<b>Endian</b> [Modbus Protocol]	Select <b>Little</b> or <b>Big</b> endian mode for ModBus protocol.
<b>Bayern-Hessen Serial ID</b> [Bayern-Hessen Protocol]	This is the Bayern-Hessen ID used by the Bayern-Hessen Protocol.
<b>CO2 ID</b> [Bayern-Hessen Protocol]	This is the ID of the CO <sub>2</sub> gas used by the Bayern-Hessen Protocol.



### 3.4.30 Bluetooth Menu

Main Menu → Communications Menu → Bluetooth Menu

This instrument supports Bluetooth communication through the Serinus Remote Android Application (refer to Section 4.7).

<b>Bluetooth</b>	This field indicates whether the instrument is remotely connected to an Android device.
<b>Reset</b>	After changing the ID or PIN, it is necessary to reboot the Bluetooth module. This is done by resetting the instrument or by using this menu item to reboot only the Bluetooth.
<b>ID</b>	This is the Bluetooth ID of the instrument. Use the keypad to edit this field. The default ID setting is <b>Serinus(Ecotech ID)</b> . The word <b>Serinus</b> is always the first part of the name and cannot be edited. The second part is the <b>Ecotech ID</b> .

### 3.4.31 Trend Display Menu

Main Menu → Communications Menu → Trend Display Menu

<b>Parameter</b>	Allows the user to select a parameter from 0 - 254 to graph on the trend display.
<b>Name</b>	Displays the name of the <b>Parameter</b> the user has selected.
<b>Autoscale</b>	Autoscale can be on or off. When it is “On” the parameter will be scaled automatically for user convenience based on the current values logged.
<b>Min</b>	This is the minimum scale of the chart as defined by the <b>Autoscale</b> or the user.
<b>Max</b>	This is the maximum scale of the chart as defined by the <b>Autoscale</b> or the user.
<b>Clear</b>	Clears the current data points in the <b>Chart</b> .
<b>Data Log Interval</b>	The data log interval can be user set from 1 sec interval up to 24 hours.
<b>Chart</b>	This field enters a screen with a graph of the user selected <b>Parameter</b> (Refer to Section 3.4.32).

### 3.4.32 Chart

Main Menu → Communications Menu → Trend Display Menu → Chart

The chart allows the user to select a parameter and view it in a real time chart. The user can select from the 254 parameters available (refer to Table 21). Changing the logged parameter will reset the chart. However, up to the first four Instantons gas and Ozone values are always memorized. Changing the Data Log Interval resets all charts.

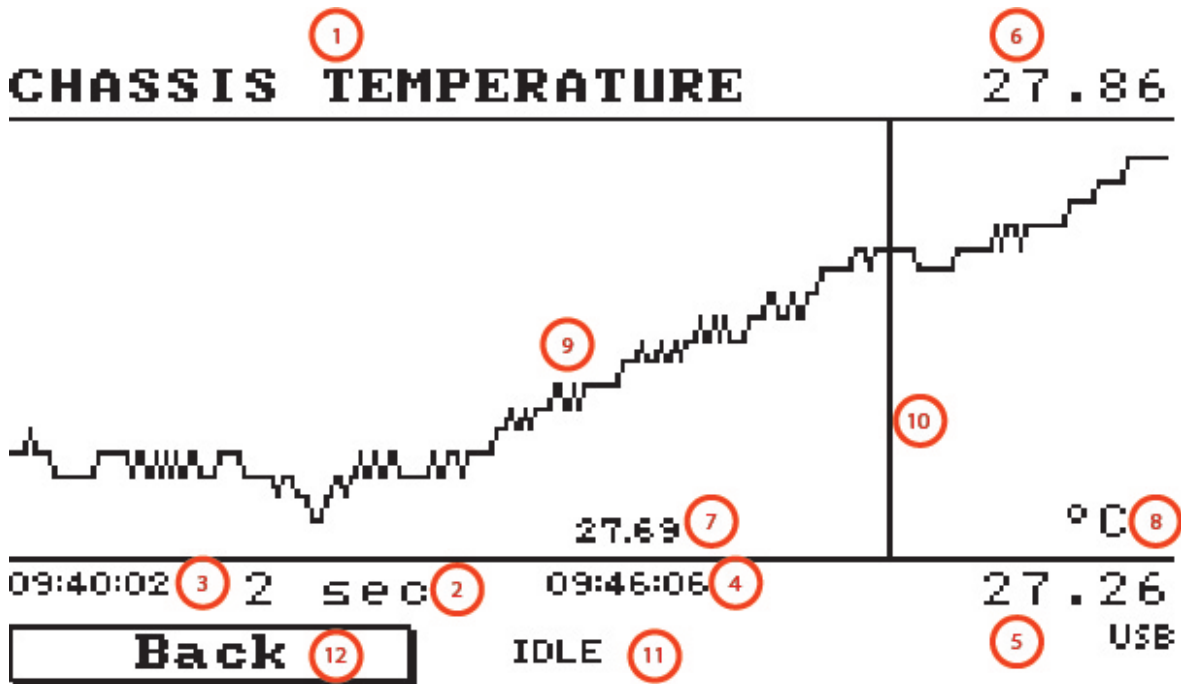

Figure 12 – Chart Screen

### Chart Title (1)

Displays the name of the parameter as it would be displayed on the advanced protocol parameter list.

### Data Log Interval (2)

Displays the value of the data logging interval as determined by the user in the Trend Display Menu (refer to Section **Error! Reference source not found.**).

### Chart X-Axis (3 & 4)

(3) Displays the time stamp for the oldest data point (left hand side).

(4) Displays the time stamp for the newest data point (right hand side) or if the cursor is active it displays the current cursor data point time stamp.

### Chart Y-Axis (5 & 6)

(5) This is the minimum scale as defined by the autoscale or the user (refer to section **Error! Reference source not found.** ).

(6) This is the maximum scale as defined by the autoscale or the user (refer to section **Error! Reference source not found.** ).

### Current Data Point Value (7)

Displays the current value of the newest data point unless the **cursor** is active then it displays the current cursor data point value.

## Units (8)

Displays the units of measure for the parameter that the user has selected.

## Data Points (9)

Displays the last 240 data points recorded for the selected parameter.

## Chart Cursor (10)

If the user wishes to know the value at any at a particular data point on the chart, the cursor can be used. The cursor is activated by pressing the ( - ) key on the keypad and is represented by a vertical line on the chart. The cursor can be moved left or right by the ( - ) or ( + ) key respectively. This cursor location now represents the current data point value of interest. The cursor will stay with the chosen data point and move with the updating chart. When the cursor finally hits the end of the chart it deactivates and the current data point value will now be the latest data point entering the chart.

## Mode (11)

This Field indicates the mode the instrument is currently running.

## Back (12)

Pressing back allows the user to access other menu items while the chart is still logging in the background.

Digital Output State	Description
Left Selection Button	Returns the user back to the trend display menu.
Scrolling Buttons	Using the scrolling buttons will cycle through the user selected parameter as well as any default gas(es) currently logging.
- Button	Pressing the ( - ) button will bring up the cursor and move it to the left.
+ Button	Pressing the ( + ) button will move the cursor to the right. When the cursor moves all the way to the right due to the chart moving it will deactivate.

### 3.4.33 Advanced Menu

This menu is accessed via a different method than the other menus. From the **Home Screen** press the following keys:

( $\bar{\cdot}$ )99( $\bar{\cdot}$ )<sub>SPACE</sub>

This menu contains technical settings, diagnostics and factory hardware installations. No items in this menu should be accessed without authorisation and supervision of qualified service personnel.

Language	Select a language.
Hardware Menu	Refer to Section 3.4.34

<b>Service Displays</b>	When set to <b>On</b> , new items appear on many different menus. These fields are for diagnostic and service personnel only. Default is <b>Off</b> .
<b>Next Service Due</b>	Enables the user to edit the next service due date.
<b>Jump to Next State</b>	Moves the sequence to the next state (e.g. from Fill to Measure). This command is most commonly used to force an instrument out of the warm-up sequence early.
<b>Parameter Display Menu</b>	Refer to Section 3.4.35.
<b>Reset to Factory Defaults</b>	Reset the configuration to factory defaults. This will erase all calibrations and user configuration information.
<b>Rebuild Index</b>	If a data log becomes corrupted it may be possible to restore it by rebuilding its index file. This command will ask you to specify a month and will rebuild the index for that month. This operation can take many minutes and it should not be interrupted. While the file is rebuilding any data logging will be suspended.



**CAUTION**  
 No items in this menu should be accessed without authorization and supervision of qualified service personnel.

### 3.4.34 Hardware Menu

#### Advanced Menu → Hardware Menu

This menu contains factory hardware installations. If you reset to factory defaults you may need to revisit this menu to enable your installed optional features.

<b>Model</b>	Select the instrument model. Normally this only needs to be reset when the configuration is corrupted. The selections available will depend on licensing. It is not recommended to run an instrument with firmware set to an incorrect model.
<b>Front Panel Style</b>	Choosing the incorrect front panel will result in the traffic lights behaving inconsistently. Default is <b>Aluminium</b> .
<b>Network Port</b>	When <b>Enabled</b> indicates the instrument has a network port installed. Default is <b>Disabled</b> .
<b>Internal Pump</b>	When <b>Enabled</b> indicates the instrument has an Internal pump installed. Default is <b>Disabled</b> .
<b>Orifice Size</b> [Internal Pump Option Disabled]	Specify the input orifice for instruments without an internal pump. Default is <b>1.08</b> for <b>Standard</b> range instruments and <b>1.50</b> for <b>High</b> range instruments.
<b>External Bkgnds</b>	When <b>Enabled</b> the system will not perform automatic backgrounds and it will not warn you that it is not doing backgrounds. Rather it is the responsibility of the operator to remotely trigger the backgrounds. Default is <b>Disabled</b> .



#### CAUTION

No items in this menu should be accessed without authorization and supervision of qualified service personnel.

### 3.4.35 Parameter Display Menu

#### Advanced Menu → Parameter Display Menu

Used to display a parameter in real-time on the screen (refer to Table 21 for a full list of parameters).

<b>Data Parameter</b>	This is an editable field. Enter the parameter number you wish to view (refer to Table 21).
<b>Name</b>	Displays the name of the selected parameter.
<b>Value</b>	Displays the current value of the selected parameter.

This page is intentionally blank

## 4. Communications

The Serinus has a number of different interfaces for communication with other equipment (RS232, USB, 25 pin digital/analog input/output, TCP/IP network (optional) and Bluetooth). A demonstration version of Ecotech's **Airodis** software is included with the instrument, enabling basic data downloads and remote operation from a PC running MS Windows (7 or 8). The full version of Airodis is available separately and includes automated data collection, data validation and complex reporting by multiple users. Please refer to the Airodis Manual and Section 4.6 for details on setting up and communicating with the instrument.

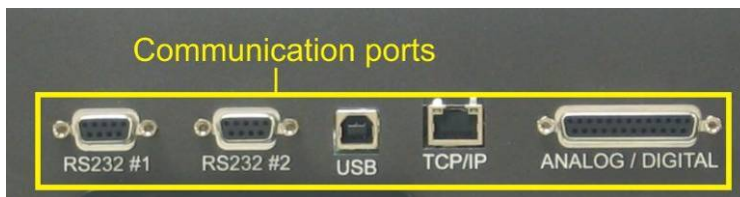

Figure 13 – Communication Ports

### 4.1 RS232 Communication

RS232 communication is a very reliable way to access data from the instrument and is recommended for use in connection to a data logger for 24/7 communication. Both RS232 ports are configured as DCE and can be connected to DTE (Data Terminal Equipment such as a data logger or computer).

Port #2 also supports a multidrop arrangement (a configuration of multiple instruments connected via the same RS232 cable where the transmit signal is only asserted by the instrument that is spoken to).

For reliable multidrop RS232 communications please follow these guidelines:

- Verify that the Serial ID is set to a unique value which is different to the other instruments in the chain (refer to Section 3.4.24).
- All of the instruments in the multidrop chain must have the same baud rate and communication protocol settings. A maximum of 9600 baud rate is recommended.
- The multidrop RS232 cable should be kept to less than three meters in length.
- A 12K ohm terminating resistor should be placed on the last connector of the cable (connect from pin 2 to pin 5 and from pin 3 to pin 5 – refer to Figure 14).
- The shielding of the multidrop cable must be continuous throughout the cable.
- The shielding of the multidrop cable must only be terminated at one end. It should be connected to the metal shell of the DB 9 way connector.

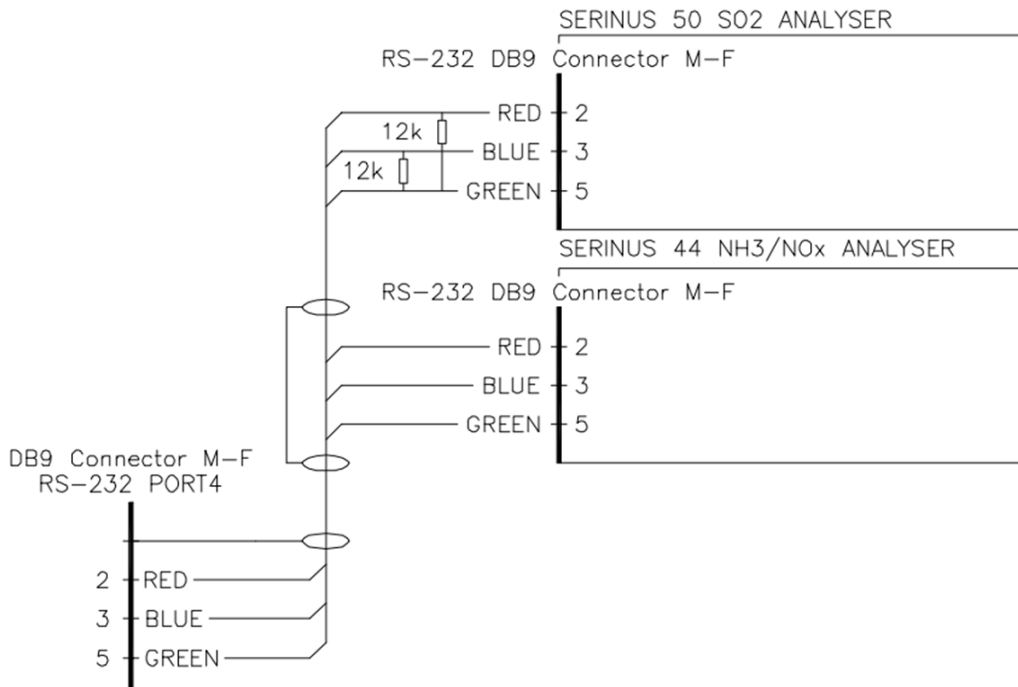

Figure 14 – Multidrop RS232 Cable Example

## 4.2 USB Communication

This is ideal for irregular connection to a laptop running Ecotech’s **Airodis** software to download logged data and remotely control the instrument. Due to the nature of USB, this is a less reliable permanent connection as external electrical noise can cause USB disconnection errors on a data logger.

For more information on making connections refer to Section 4.6.1.1.

**Note:** Only the Advanced protocol is supported for USB communication.



### 4.3 TCP/IP Network Communication (optional)

Instruments with the optional network port installed can be accessed using a TCP/IP connection. Figure 15 shows examples of some possible configurations for remote access.

#### Direct Connection

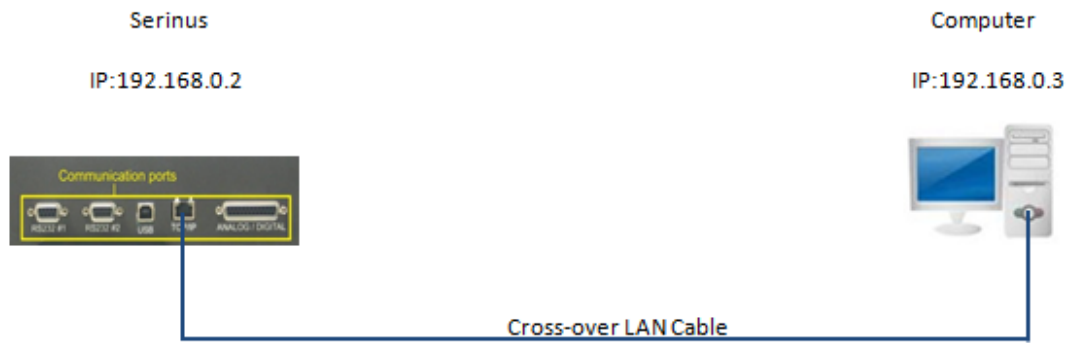

#### LAN

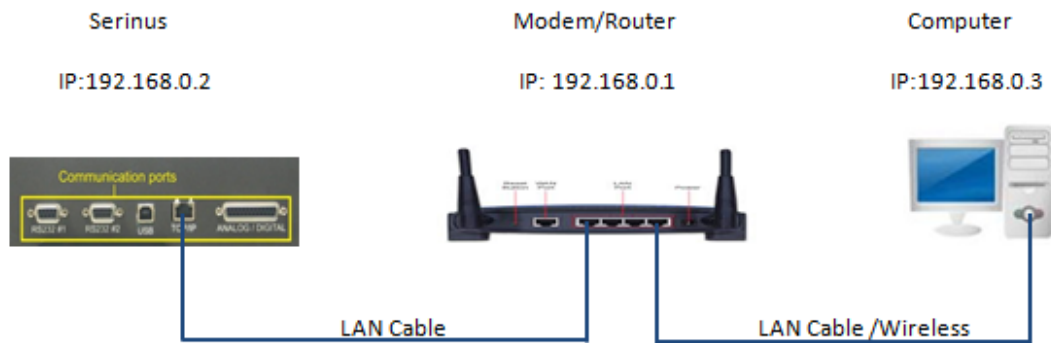

#### WAN

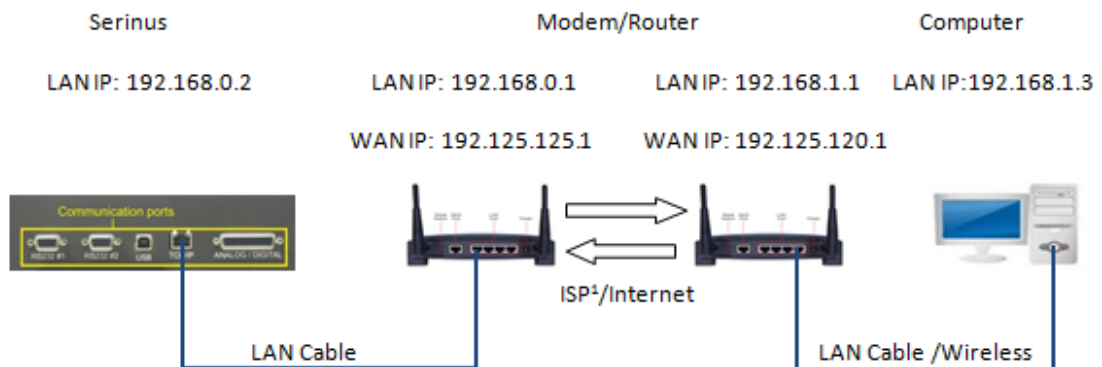

<sup>1</sup> ISP: Internet Service Provider

Figure 15 – Example of Typical Network Setups

**Note:** In Figure 15 all the IP addresses are taken as an example. The WAN IP addresses are normally provided by your ISP. Whereas, the LAN IP addresses can be set manually to any range which is within the subnet of the Modem/Router/switch.

Use a cross-over LAN cable to connect the instrument directly to a computer, or a standard LAN cable for connection to a Modem/Router/Switch as shown in Figure 15. The computer could be connected to the Modem/Router using either CAT5 cable or a wireless connection, but the instrument must be connected using CAT5/6 cable.

#### 4.3.1 Reading Network Port Setup

To read the current network port settings perform the following steps:

##### Procedure

1. Open - **Main Menu** → **Communications Menu** → **Network Menu**.
2. Select - **Start-up Mode** → **Read IP** - Accept.
3. Manually use the power switch on the rear of the instrument to turn the power Off. Please leave the instrument off for 10 seconds before turning the power back On.
4. Open - **Main Menu** → **Communications Menu** → **Network Menu**.
5. The current network port settings will now be displayed on the screen.
6. When viewing is complete select - **Start-up Mode** → **Normal** - Accept.

#### 4.3.2 Setting Network Port Setup

Below is an example of how to setup the network port.

##### Procedure

1. Open - **Main Menu** → **Communications Menu** → **Network Menu**.
2. Select - **Protocol** → **Advanced** - Accept.
3. Edit - **IP Address** - (Change the IP address to the address you wish to use within the Modem/Router/switch subnet).
4. Edit - **Netmask** - (Change the Netmask to the setup specified by the Modem/Router).
5. Edit - **Gateway** - (Change the Gateway to the setup specified by the Modem/Router).
6. Select - **Start-up Mode** → **Set IP** - Accept.

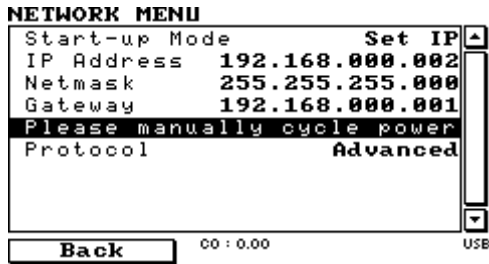

**Figure 16 – Example of Network Menu Setup**

- Once completed, use the power switch on the rear of the instrument to turn the power Off. Please leave the instrument off for 10 seconds before turning the power back On.

**Note:** Manually perform a hardware power cycle every time the IP address is changed for it to take effect.

- Open - **Main Menu → Communications Menu → Network Menu.**
- The **Start-up Mode** automatically changes to **Read IP** and the current network port settings will be displayed on the screen.
- When viewing is complete select - **Start-up Mode → Normal** - Accept.

### 4.3.3 Port Forwarding on Remote Modem/Router Setup

When using the network port to connect to the router / modem with NAT enabled, you will need to add IP mapping to ensure that data is forwarded through to the desired port. This is known as port forwarding. To set-up the port for the instrument, you will need to go into the modem/router configuration. Normally, you will see the port forwarding setup under Port Forwarding, NAT or Port Mapping menu. Below is an example port forwarding setup.

The default port for the Serinus range of instruments is **32783**. The destination address is the instrument IP address setup in the **Network Menu**.

Item	Protocol	Incoming Address	Incoming Port	Destination Address	Destination Port
1	tcp	0.0.0.0	32783 - 32783	192.168.0.2	32783 - 32783

**Figure 17 – Port Forwarding Example**

### 4.3.4 Airodis Setup to Communicate with Serinus

Below is an example of Airodis setup for a LAN network. Ensure the IP address is set to the same as on the instrument **Network Menu**.

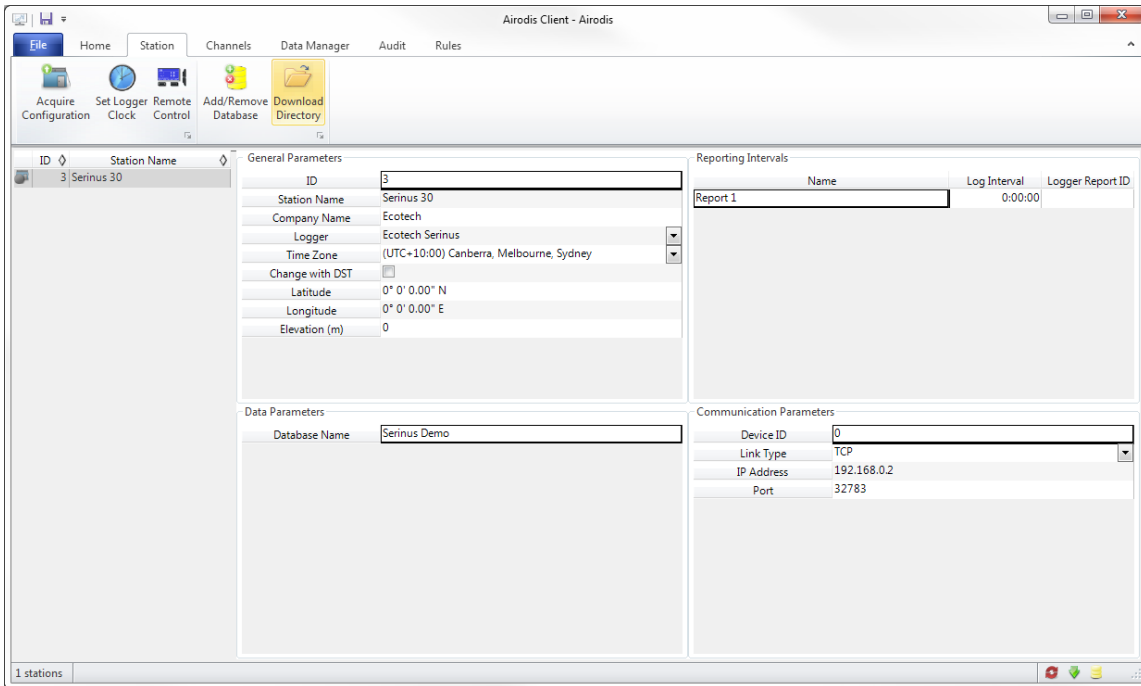

Figure 18 – LAN Network Set-Up (Airodis)

Below is an example of Airodis setup for a WAN network. Ensure the IP address is set the same as on the remote modem/router.

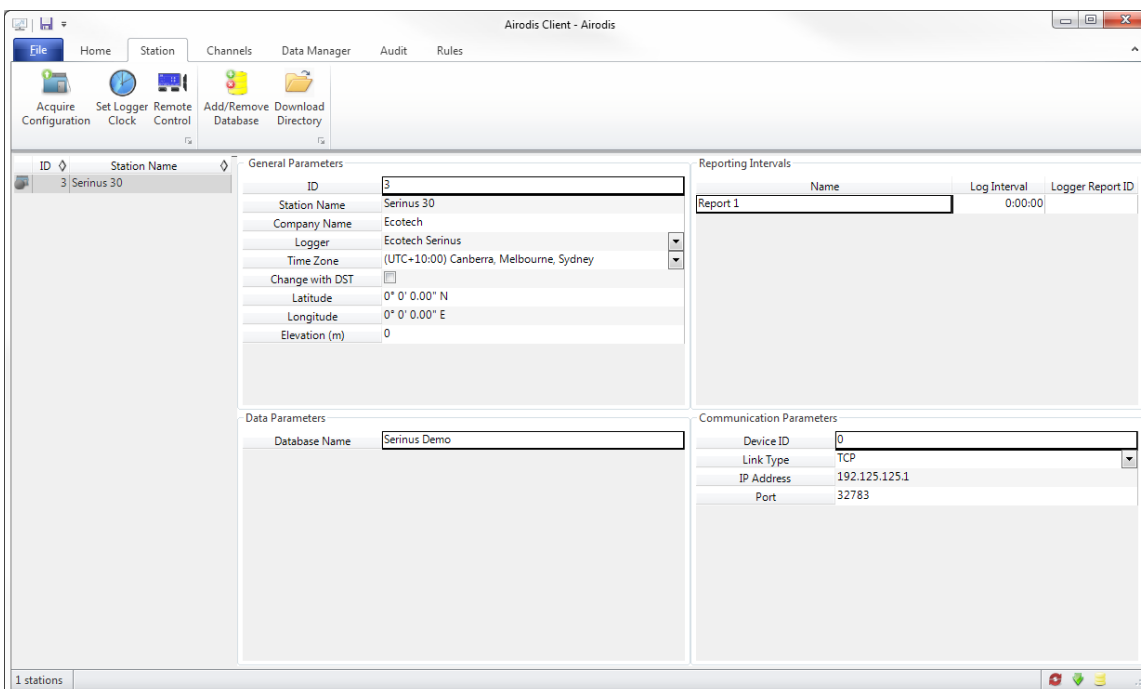

Figure 19 – WAN Network Set-Up (Airodis)

---

## 4.4 Analog and Digital Communication

---

The 25 Pin analog and digital I/O port on the rear of the instrument sends and receives analog and digital signals to other devices. These signals are commonly used to activate gas calibrators or for warning alarms.

### 4.4.1 Analog Outputs

The instrument is equipped with three analog outputs that can be set to provide either voltage (0-5 0.25-5 or 0.5-5 V) or current (0-20, 2-20 or 4-20 mA) output. The analog outputs are tied to user selected parameters (refer to Table 21).

For 0-10 V analog output operation, set the output mode to current and move the jumpers (JP3) on the rear panel PCA to 0-10 V (refer to Figure 20). Ensure the Current Range is set to 0-20 mA to obtain the 0-10 V range. When calibrating the (current) analog output with the jumper set to 0-10 V, the 4 mA calibration target is now a 2 V target and 20 mA calibration target is now a 10 V target.

#### 4.4.1.1 Analog Outputs Voltage Calibration

##### Equipment Required

- Multimeter (set to volts)
- Male 25 pin connector with cable

##### Procedure

1. Open - **Main Menu** → **Communications Menu** → **Analog Output Menu** (refer to Section 3.4.26).
2. Select - **Output Mode** → **Voltage**.
3. Connect a multimeter (using an appropriate adaptor or probes on the multimeter) to the ground (pin 24) and the relevant output pin (pin 10).
4. Edit - **0.5V Calibration** - (until the multimeter reads 0.500 V  $\pm$ 0.002) - Accept.
5. Edit - **5.0V Calibration** - (until the multimeter reads 5.00 V  $\pm$ 0.002) - Accept.

#### 4.4.1.2 Analog Outputs Current Calibration

##### Equipment Required

- Multimeter (set to mA)
- Male 25 pin connector with cable

##### Procedure

1. Open - **Main Menu** → **Communications Menu** → **Analog Output Menu** (refer to Section 3.4.26).
2. Select - **Output Mode** → **Current**.
3. Connect a multimeter (using an appropriate adaptor or probes on the multimeter) to the ground (pin 24) and the relevant output pin (pin 10).
4. Edit - **4mA Calibration** - (until the multimeter reads 4 mA  $\pm$ 0.01) - Accept.

5. Edit - **20mA Calibration** - (until the multimeter reads 20 mA  $\pm$ 0.01) - Accept.

#### 4.4.2 Analog Inputs

The instrument is also equipped with three analog inputs with resolution of 15 bits plus polarity, accepting a voltage between 0-5 V. These go directly to the microprocessor and should be protected to ensure static/high voltage does damage the main controller PCA (instrument warranty does not cover damage from external inputs).

#### 4.4.3 Digital Status Inputs

The instrument is equipped with eight logic level inputs for the external control of the instrument such as Zero or Span sequences. Each input has a terminating resistor which can be either PULL UP or PULL DOWN. This is set using the jumper JP1 on the back panel PCA (refer to Figure 20).

#### 4.4.4 Digital Status Outputs

The instrument is equipped with eight open collector outputs which will convey instrument status condition warning alarms such as no flow, sample mode, etc. Two of the digital outputs can be set so that there is +5 V and +12 V available on the 25 pin connector for control purposes, instead of digital outputs 0 and 1.

In the default jumper locations (refer to Figure 20) these two outputs will function normally as open collector outputs. If moved to the position closer to the 25 pin connector then the DO 0 will supply +12 V and DO 1 will supply +5 V.

The +12 V and +5 V supplies are limited to about 100 mA each.

Each digital output is limited to a maximum of 400 mA. The total combined currents should not exceed 2 A.

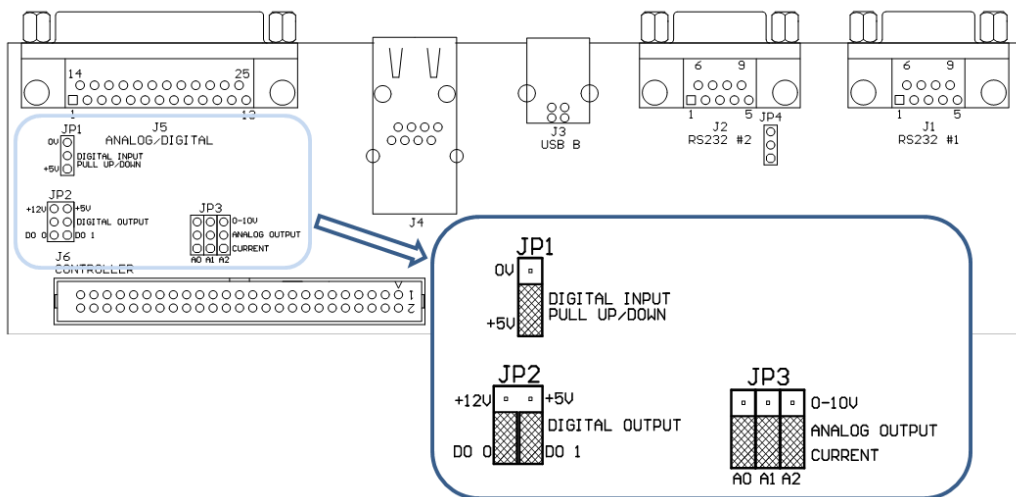
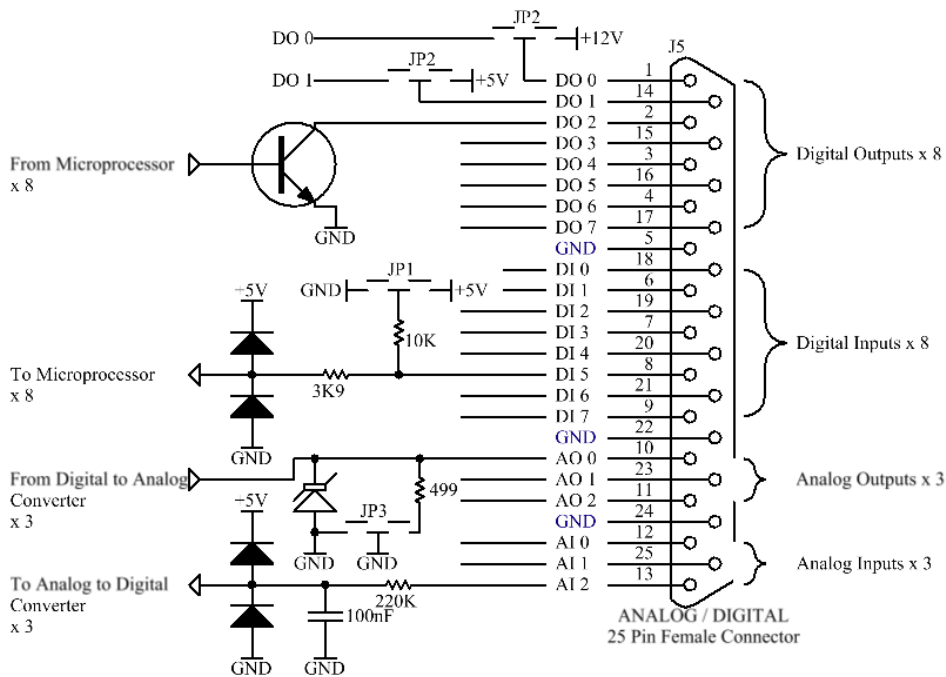

Figure 20 – 25 Pin Rear Panel PCA (Default Jumpers Highlighted)



**Figure 21 – External 25 Pin I/O Individual Pin Descriptions**



**CAUTION**

The analog and digital inputs and outputs are rated to CAT I. Exceeding 12 VDC or drawing greater than 400 mA on a single output or a total greater than 2 A across the eight outputs can permanently damage the instrument and void the warranty.

## 4.5 Logging Data

When the user receives the instrument from the factory it will have a default set of parameters already setup in the internal data logger. These select few parameters have been chosen for their relevance in assisting in troubleshooting the instrument.

### 4.5.1 Configure Instrument Internal Logging

In order to log data you must first specify a data logging interval. This is how often data will be logged to the USB memory stick. You can log a maximum of 12 parameters. These parameters can be selected by name or by parameter number using the parameter list as a reference (refer to Table 21).

#### 4.5.1.1 Data Log Setup –Numeric

##### Procedure

1. Open - **Main Menu** → **Communications Menu** → **Data Logging Menu** (refer to Section 3.4.23).
2. Select - **Data Log Interval** - (adjust to the desired value) - Accept.

3. Open - **Data Log Setup –Numeric** - (select the parameter numbers you wish to log).
4. Edit - (Change one of the storage locations “Parameter 1-12” to the parameter number you wish to log) - Accept

#### 4.5.1.2 Data Log –Text

##### Procedure

1. Open - **Main Menu → Communications Menu → Data Logging Menu** (refer to Section 3.4.23).
2. Select - **Data Log Interval** - (adjust to the desired value) - Accept.
3. Open - **Data Log Setup –Text** - (select the names of the parameters you wish to log).
4. Select - (Change one of the storage locations “P1-P12” to the parameter text you wish to log) - Accept.

---

## 4.6 Using Airodis Software to Download Data

### 4.6.1 Connecting the Instrument to Your PC

The instrument can communicate with a PC using RS-232 (Serial), TCP/IP (Network), Bluetooth or USB. Serial, Bluetooth and network communications do not require additional drivers. If you wish to connect using a USB cable, the driver must first be installed.

#### 4.6.1.1 Connecting Over USB

If you wish to connect using USB, you will need to first install the Serinus USB driver.

Power on the instrument and connect it to your PC with a USB cable. You should receive a prompt if the driver needs to be installed. If not, open Device Manager (Under “System” in Control Panel), find the device and select “Update Driver Software”.

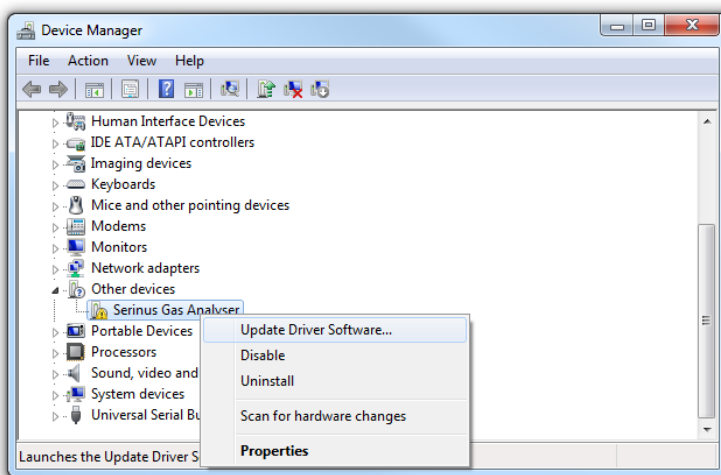

**Figure 22 – Installing Driver Software (Device Manager)**

When prompted where to search for the driver, select “**Browse my computer for driver software**”.



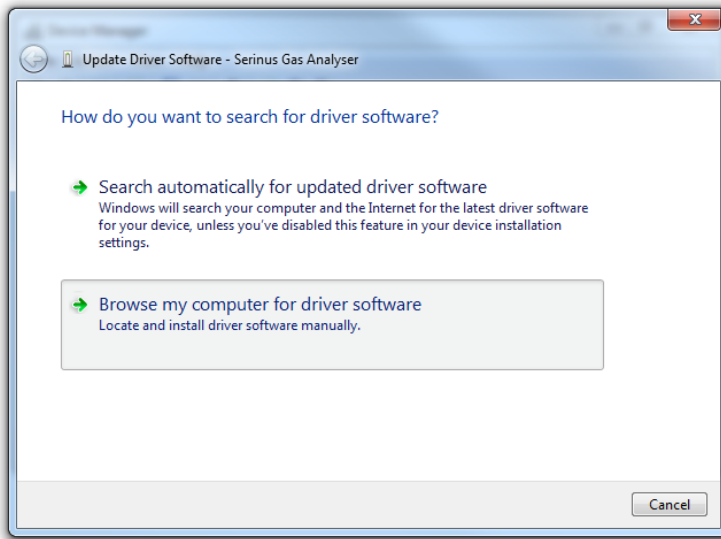

**Figure 23 – Update Driver Popup**

The Serinus USB driver is located on the green Ecotech resources USB stick under “\Drivers\Ecotech Analyser”. Select this directory and click **Next**.

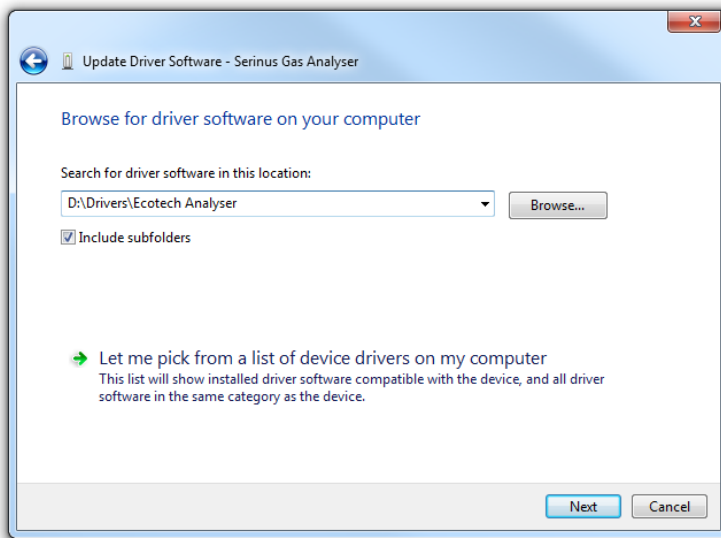

**Figure 24 – Update Driver Popup (Directory Location)**

If you receive a confirmation prompt to install the driver, select **Install**.

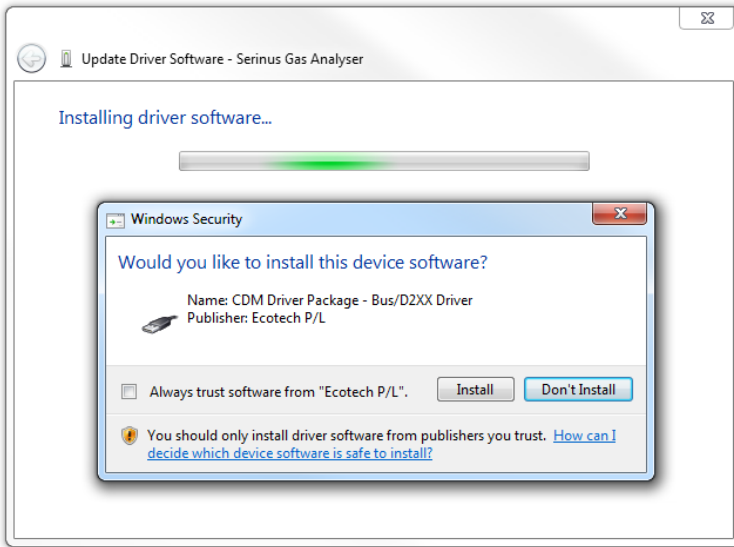

**Figure 25 – Installing Driver Confirmation Prompt**

If everything went smoothly, Windows will inform you that the driver was successfully installed.

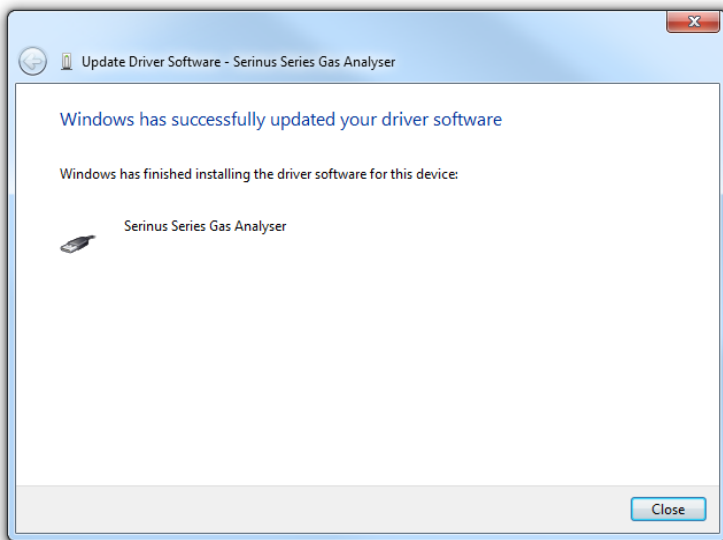

**Figure 26 – Successful Driver Installation**

#### 4.6.1.2 Connecting Over Serial (RS-232)

The following steps outline how to setup the instrument for connection to a PC or datalogger (refer to Section 3.4.24).

#### Procedure

1. Open - **Main Menu** → **Communication Menu** → **Serial Communication Menu**.
2. Determine which RS232 Port you are physically making the connection with. Remember, multidrop is only supported on RS232 #2.
3. Select - **Baudrate** → **38400** - Accept (Set an appropriate baud rate, default is 38400).

4. Select - **Protocol** → **Advanced** - Accept.

If you are running Airodis in a multidrop configuration, ensure that the **Serial ID** is unique for each instrument on the chain.

#### 4.6.1.3 Connecting Over Network (TCP/IP)

The following steps outline how to setup the instrument for connection to a PC or datalogger (refer to Section 3.4.29).

##### Procedure

1. Open - **Main Menu** → **Communication Menu** → **Network Menu**.
2. Select - **Start-up Mode** → **Set IP** - Accept.
3. Assign a unique static IP address to the instrument.
4. Select - **Protocol** → **Advanced** - Accept.
5. Reboot the instrument by cycling the power.

#### 4.6.2 Installing Airodis

The user can download data from the instrument using either a full retail (paid) version of Airodis or with the demo version which is included on the green Ecotech resources USB stick. The demo version has limited functionality, but will allow you to download and export data from up to three instruments. If you do not already have Airodis, this can be obtained from Ecotech:

<http://www.airodis.com.au>

The installer is straightforward: Ensure you install the correct version for your operating system. If you are running 64-bit windows, install the 64-bit (x64) version. Otherwise, install the 32-bit (x86) version.

#### 4.6.3 Configuring Airodis

1. Once installed, double click on the Airodis shortcut on the desktop to start Airodis Workspace Manager. You will be presented with the default workspace options. These will suffice for downloading data from the instrument.

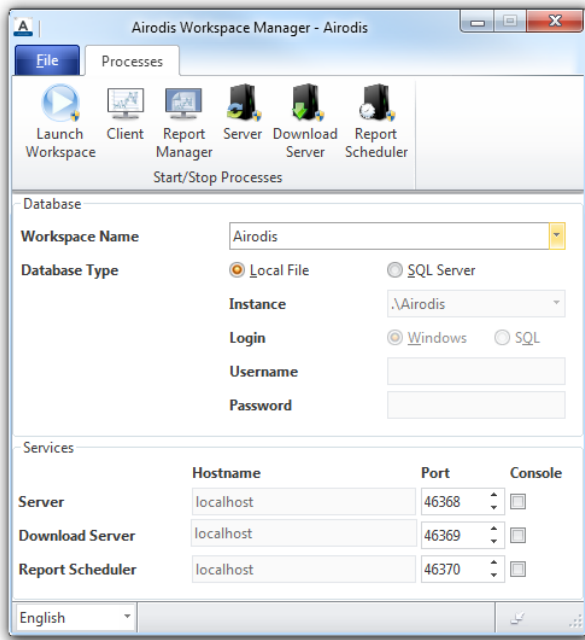

Figure 27 – Airodis Workspace Manager

2. Start the Client, Server and Download Server by single-clicking the toggle button for each. The client may prompt to register with Ecotech or install an update. Follow the prompts if it does.
3. Once the Client application has loaded, click **Home** → **Add Station** → **New Physical Station**.

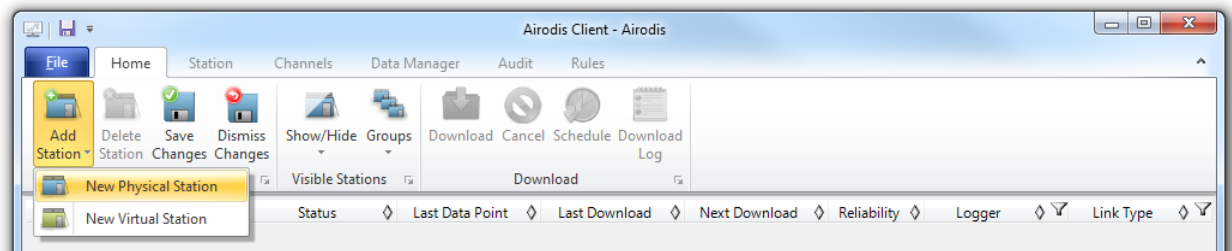
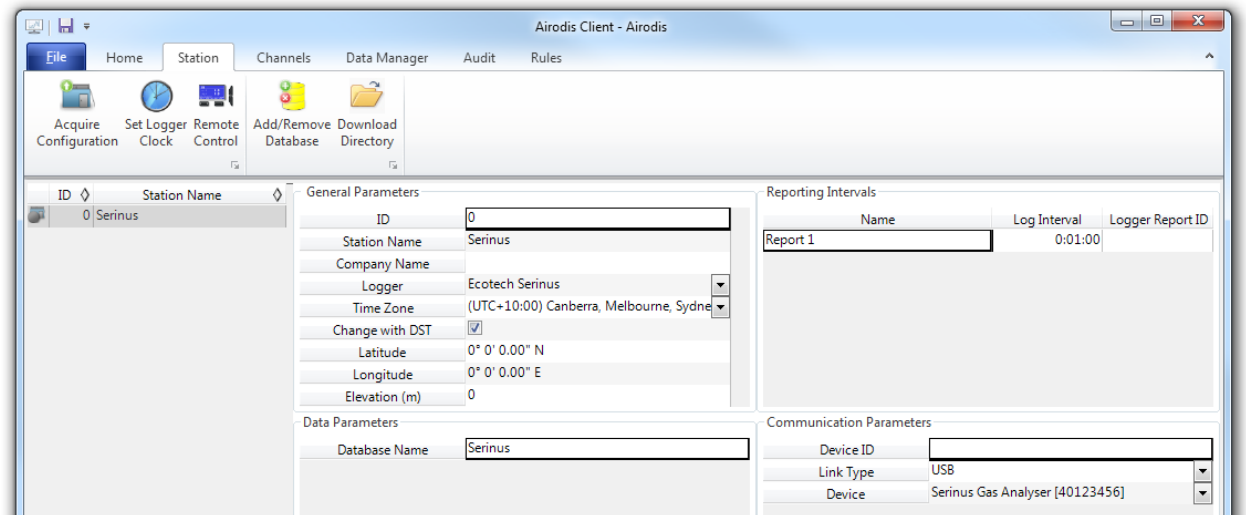

Figure 28 – Adding a New Station

4. This automatically brings you to the **Station** tab on the ribbon. Enter the communication details to connect to the instrument.



**Figure 29 – New Station Connection**

**Table 5 – New Station Setup**

Property	Description
Station Name	The name of the station. If you have other loggers, the name is used to distinguish them.
Logger	Set this to “Ecotech Serinus” when downloading from any Serinus series instrument. This will communicate with the instrument via the <b>Advanced</b> protocol. If using a network or serial connection, ensure that the Advanced protocol has also been selected on the instrument itself.
Time Zone	Set this to the time zone that the instrument is located in.
DST	Enable this option if you plan on changing the clock on the instrument with daylight savings. Leave this disabled if the clock does not shift during DST. The instrument will need to be adjusted manually for DST – it will not happen automatically.
Database Name	This is the name to be used for the table in the SQL database containing this station’s data. It must be unique for each station.
Device ID	Enter the Serial ID of the instrument. If you are not using multidrop; this can be set to “0” or left blank.
Link Type	Select the type of connection used to connect to the instrument. Different properties will appear depending on the link type selected. Align these settings with those of the instrument.
Log Interval	This needs to be the same as the <b>Data Log Interval</b> setting on the instrument.

**Note:** The available fields for communication parameters will change when you change the link type. You will need to set the communication parameters that have been defined on the instrument.

- Once the station has been created, save the station by clicking the Save shortcut icon or **File → Save**.
- Click Acquire Configuration. This will probe the instrument for a channel list. After a few seconds, the channel list should be visible in the **Channels** tab.

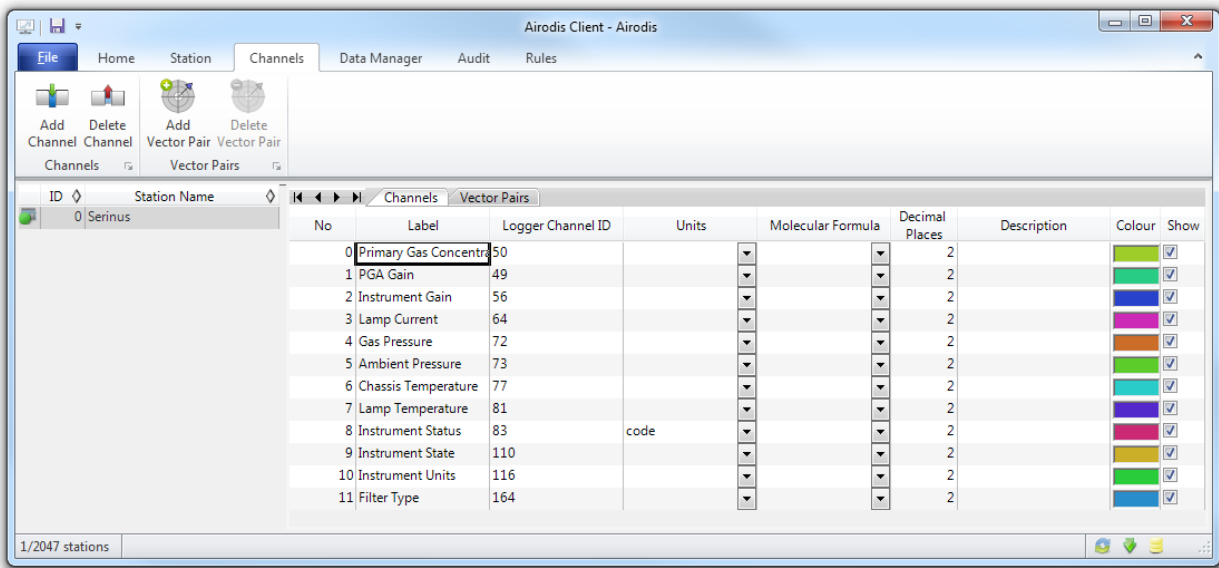

Figure 30 – Station Configuration (Channel List)

**Note:** If there was an error connecting to the instrument, a red dot will appear next to the station name in the station list (on the far left hand side). Hovering over the red dot will present you with an error message (refer to Figure 31).

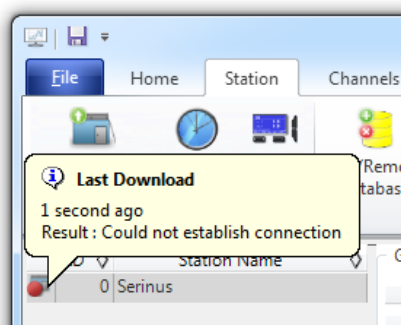
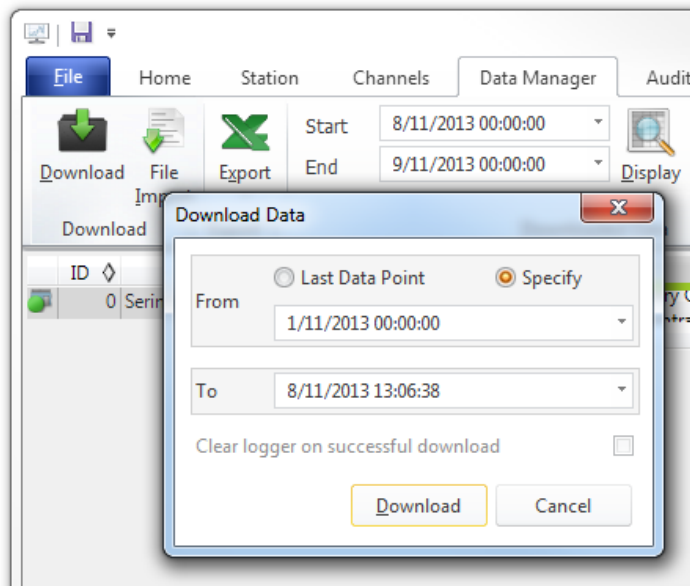

Figure 31 – Error Status Notification

7. Select the Data Manager tab, click download. The Download Data window will appear. Select the appropriate time period that you wish to download and click Download.



**Figure 32 – Downloading Data**

8. The status of the download will appear in the bottom-left corner of the window. You can also monitor the status of the download from the Home tab.

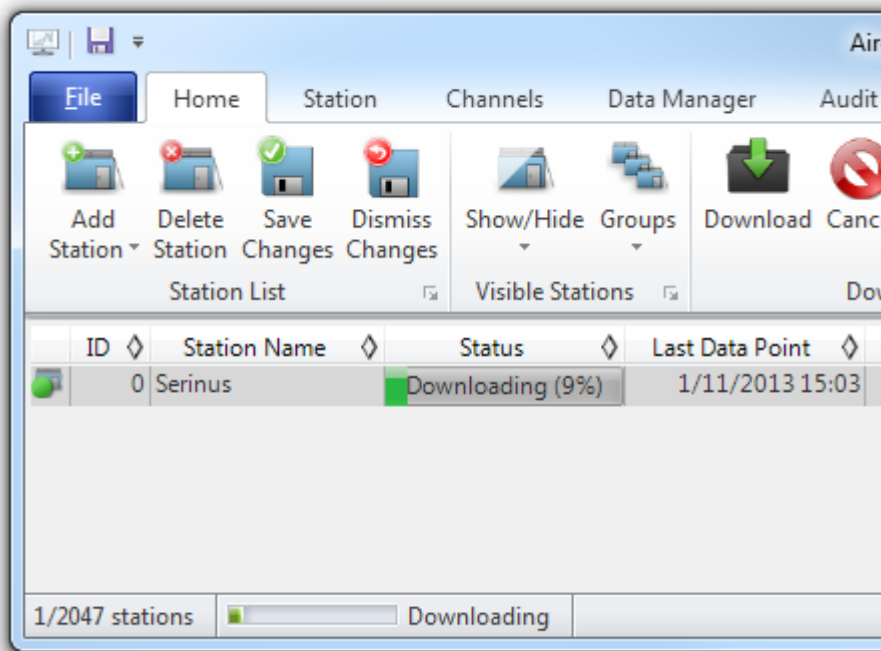

**Figure 33 – Download Data Status**

9. Data will become available in the data manager as it is downloaded. You can load data for a date range by entering the start and end dates and clicking **Display**. The selected data will be loaded into the data manager.

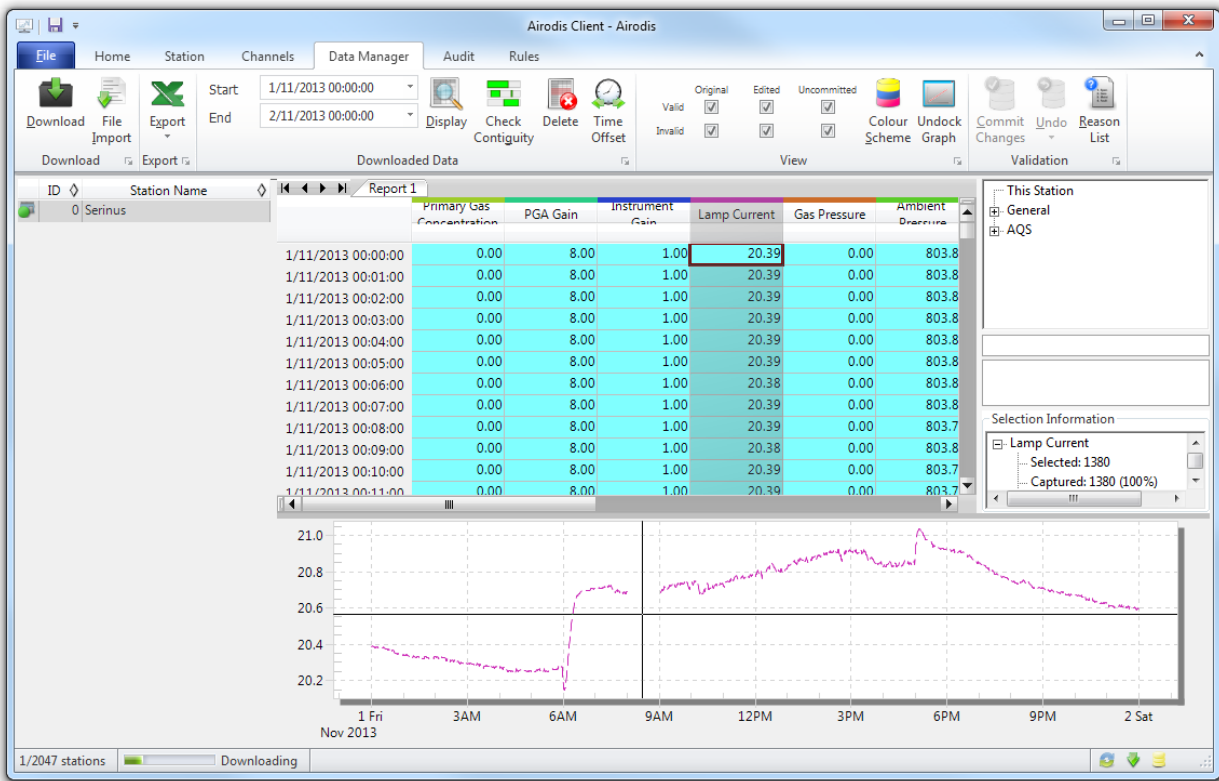

Figure 34 – Data Visibility

10. Data can be exported by clicking the Export function. This will allow you to save your data in CSV format, which can be loaded into another program such as Microsoft Excel. It is also possible to copy/paste (Ctrl + C / Ctrl + V) data directly from the Airodis data manager.

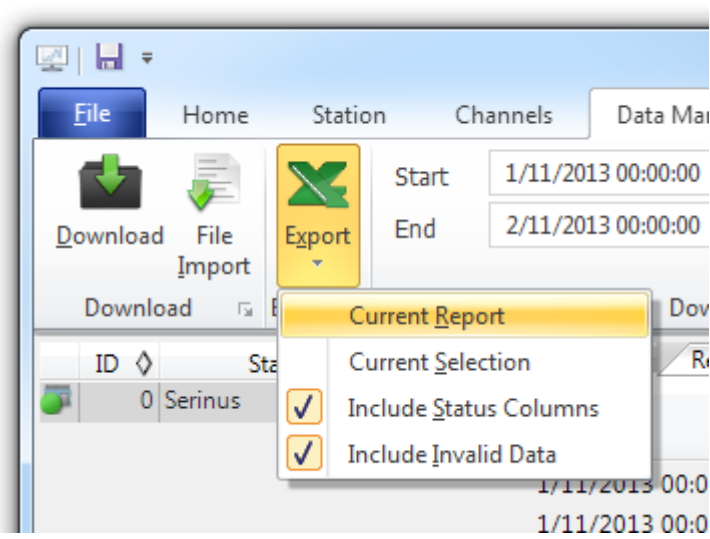
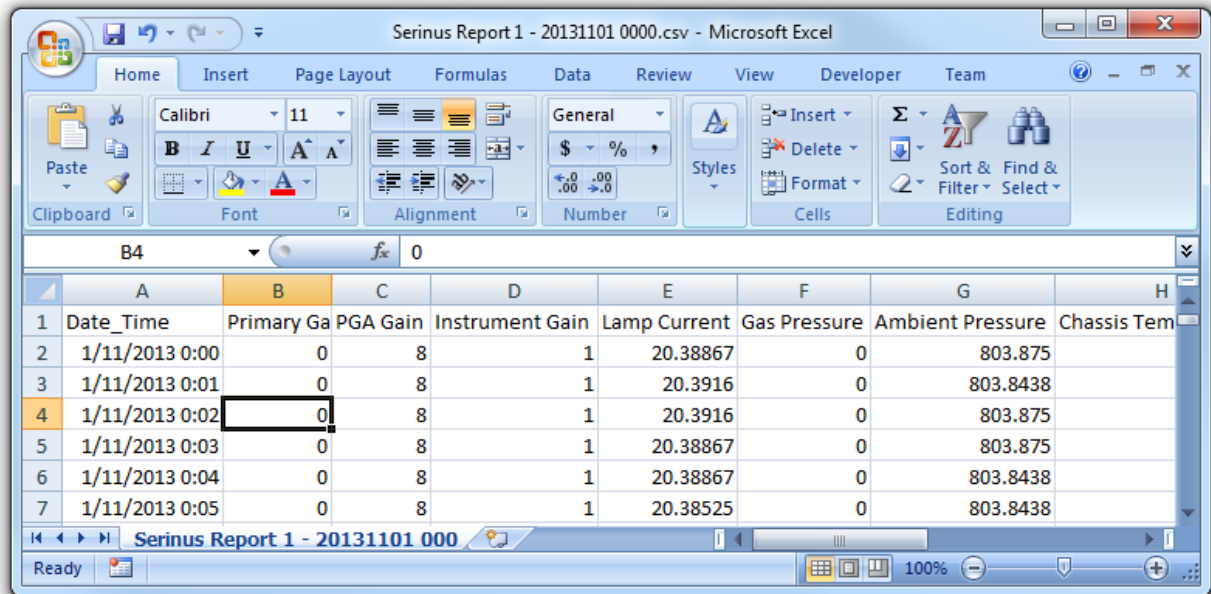

Figure 35 – Exporting Data

11. That’s it! The data has been downloaded from the instrument and exported to a standard CSV file.





	A	B	C	D	E	F	G	H
1	Date_Time	Primary Ga	PGA Gain	Instrument Gain	Lamp Current	Gas Pressure	Ambient Pressure	Chassis Tem
2	1/11/2013 0:00	0	8	1	20.38867	0	803.875	
3	1/11/2013 0:01	0	8	1	20.3916	0	803.8438	
4	1/11/2013 0:02	0	8	1	20.3916	0	803.875	
5	1/11/2013 0:03	0	8	1	20.38867	0	803.875	
6	1/11/2013 0:04	0	8	1	20.38867	0	803.8438	
7	1/11/2013 0:05	0	8	1	20.38525	0	803.8438	

Figure 36 – Data Download Complete

## 4.7 Serinus Remote App/Bluetooth

The Serinus Remote Application allows for any Android device (Tablet or Smartphone) to connect to an instrument.

The Serinus Remote Application allows the user to:

- Completely control the instrument using a remote screen displayed on the device.
- Download logged data and take snapshots of all the instrument parameters.
- Construct graphs from logged data or real time measurements.

The following sections cover installation, connection and use of the application.

### 4.7.1 Installation

The Serinus Remote Application can be found in the Google Play Store by searching for Ecotech or Serinus. Once found, choose to **Install** the application and **Open** to start the application.

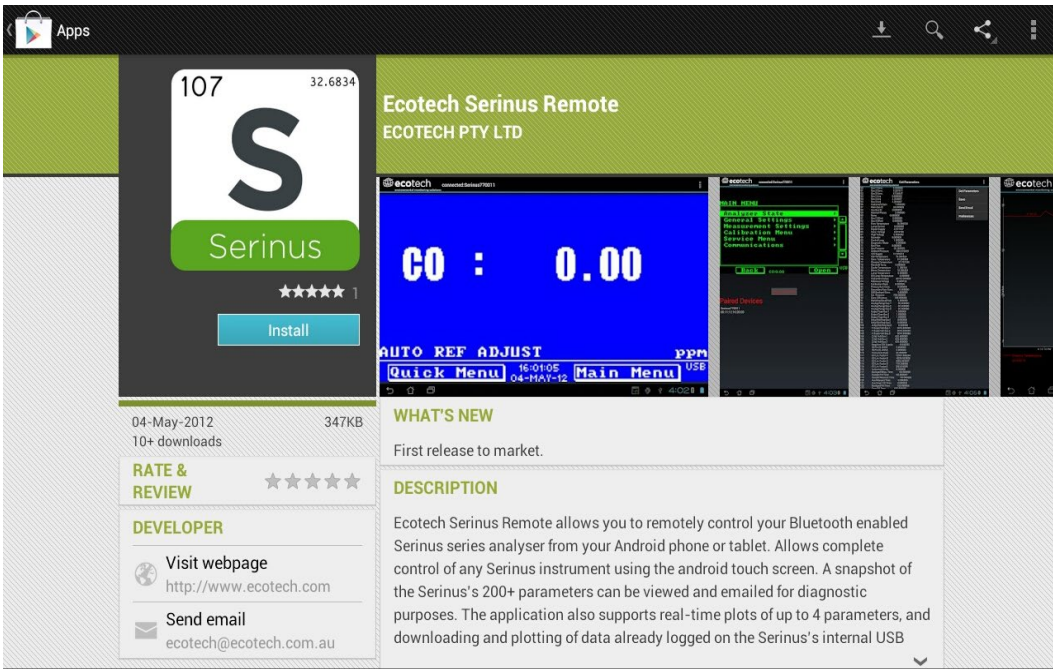

Figure 37 – Downloading the App From Google Play Store

**Note:** A menu containing additional features and functions can be accessed by entering the **Options Menu** (or similar) on your device. The location and format of this menu may vary.

#### 4.7.2 Connecting to the Instrument

##### Procedure

1. Open - **Main Menu** → **Communications Menu** → **Bluetooth Menu** (to find the Bluetooth ID and PIN) (refer to Section 3.4.30).
2. Touch the Scan Serinus Analysers button at the bottom of the screen.
3. Select the Analyser ID from either the Paired Devices or the Other Available.
4. Input the PIN (if prompted) and press OK (refer to Section 3.4.30).

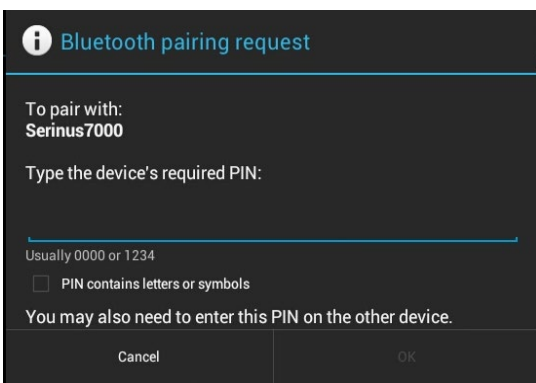

Figure 38 – Bluetooth Pairing Request

5. A screen shot of the instrument's current screen should appear on your Smartphone or tablet. To disconnect press the back key/button on the device.

**Note:** Once the instrument has been paired with the device it will appear under “Paired Devices” and the PIN will not need to be entered again. Only one Bluetooth connection can be made to an instrument at any one time.

### 4.7.3 Instrument Control

Once connected the user has full control of the instrument. The range for remote control depends on the device’s Bluetooth capabilities and any intervening obstructions, but is usually up to 30 meters.

#### Remote Screen Operation

With the exception of the number pad, all button functions/actions can be performed by touching the screen. This includes the selection buttons and the scroll buttons. Touching any part of the screen where there is not already a button also enacts the functions of the scroll buttons.

#### Home Screen

Touching the upper half of the screen increases the contrast and touching the lower half of the screen decreases contrast on the real instrument.

#### Menus

Touching the upper or lower half of the screen allows the user to scroll up and down respectively.

#### Right-hand Section of the Screen

Swiping from right to left brings up the number pad for entering numbers (swipe from left to right to hide the number pad).

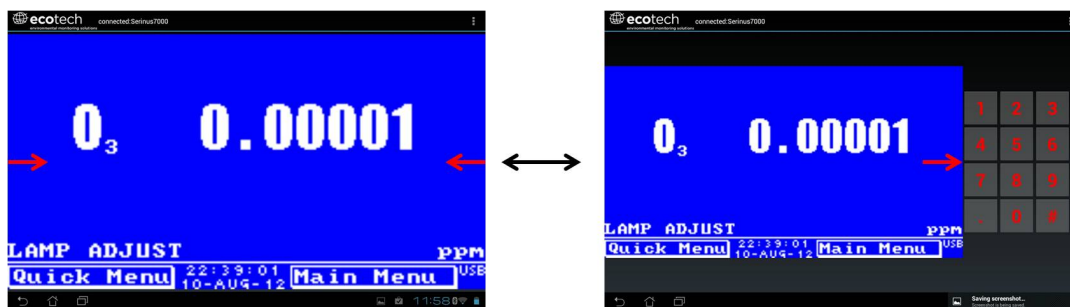

Figure 39 – Showing or Hiding the NumPad

#### Left-hand Section of the Screen

Swiping from left to right brings up a list of available analysers (swipe from right to left to hide the instrument list).

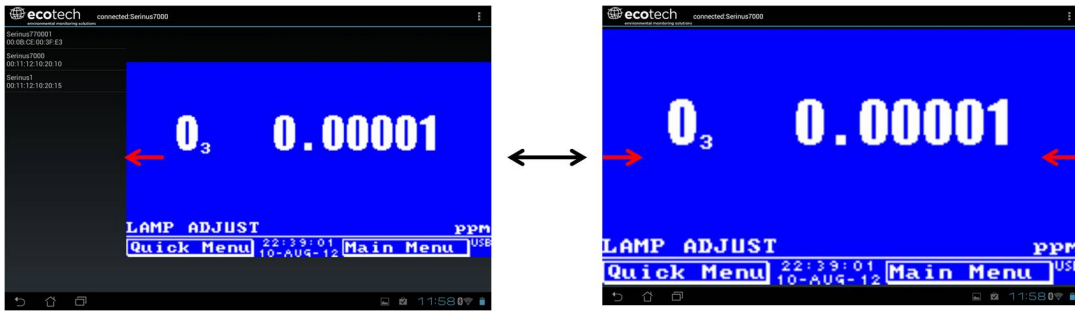

Figure 40 – Switching Analysers

## Back Button

This button will enable the user to return to the selection screen, allowing connection to a different instrument.

## Options Menu

The Options Menu is accessed by the grey button in the top right corner of the screen or pressing the Menu Button, depending on your Android device.

Refresh	Refresh the display.
Show/Hide NumPad	Show or hide the number pad.
Real Time Plot	Refer to Section 4.7.4.
Download	Refer to Section 4.7.5.
Get Parameters	Refer to Section 4.7.6.
Preferences	Refer to Section 4.7.7.

### 4.7.4 Real-Time Plot

Allows the user to view real-time plotting of up to four parameters at the same time. The user can also scroll from left to right, top to bottom or zoom in and out on the plot by swiping/pinching.

Once the plot is zoomed or scrolled, it enters into Observer Mode, meaning that auto-scaling is suspended. Press at the top of the screen (where it says Observer Mode) to return to Normal Mode.

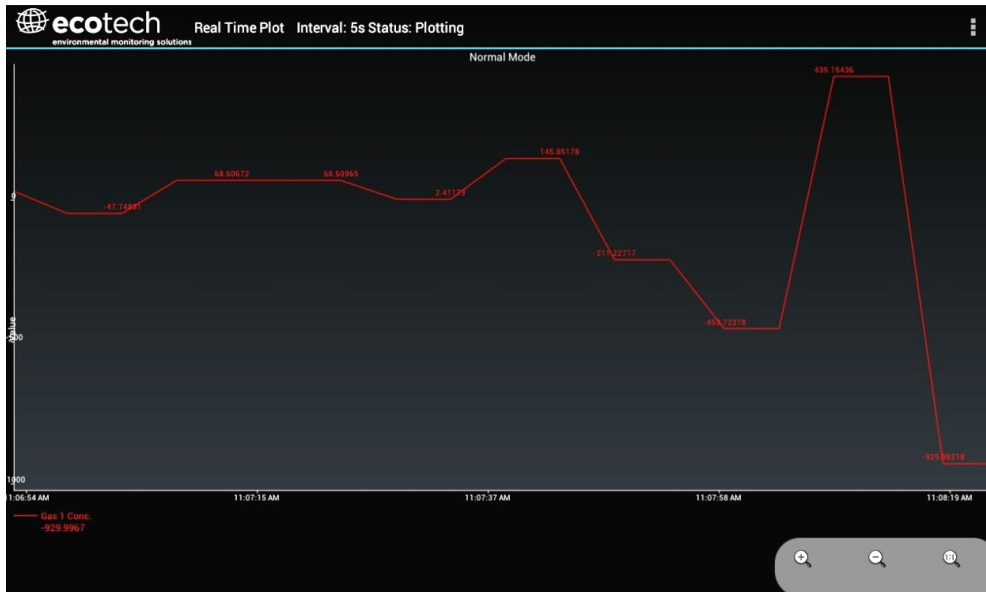

**Figure 41 – Real-Time Plot**

## Options Menu

The Options Menu is accessed by the grey button in the top right corner of the screen or pressing the menu button, depending on the Android device.

<b>Start</b>	Restarts graphing if it has been stopped and returns the graph to <b>Normal Mode</b> .
<b>Stop</b>	Stops collecting data. In this mode you can scroll the display without going into <b>Observer Mode</b> , because the system has no data collection to suspend. It is necessary to “Stop” data collection to set the interval.
<b>Clear</b>	Clears the window and restarts the graphing.
<b>Save</b>	Saves an image of the graph and accompanying data in the location specified in preferences (refer to Section 4.7.7). The user will also be asked whether they want to send the file and data via email. When saving the data, you can choose to <b>Save All Data</b> or <b>Customise</b> the length of the data by entering a time between five minutes and six hours. Only the data from the start of collection to that limit will be saved (although the plot will still appear exactly as it does on the screen).
<b>Set Interval</b>	While data collection is stopped, the user can specify the time intervals between collections.

### 4.7.5 Download

Download logged data from the USB memory stick inside the instrument. All data logged by the instrument to the USB memory stick over the period of time specified will be collected. Due to the slow connection speed of Bluetooth, this should only be used for relatively short sections of data. Downloading one days' worth of one minute data is likely to take a couple of minutes.

### Options Menu

<b>Save</b>	Generates a filename based on the start and end date/time specified. It saves the downloaded data in the location specified in preferences and asks to send the saved comma separated text file (.csv) as an attachment to an email. This file format does not include the parameter headings, just the values.
<b>Send E-Mail</b>	Sends an email with the parameter data in the body of the email, formatted as displayed (this includes the parameter name and the values).
<b>Plot</b>	Graphs the data that has been downloaded. The user is prompted to select which parameters to plot based on the parameters that were being logged (refer to Figure 42).
<b>Preferences</b>	Refer to Section 4.7.7.



Figure 42 – Plot of Downloaded Data

### 4.7.6 Get Parameters

Download a list of parameters and corresponding values directly from the instrument. This list of parameters is a snap shot of the current instrument state and is very helpful in diagnosing any problems with the instrument.

## Options Menu

Get Parameters	Refreshes the parameter list display.
Save	Generates a filename from the current date and time, saves the parameter data in the location specified in preferences and asks to send the saved text file as an attachment to an email.
Send E-Mail	Sends an email with the parameter data in the body of the email, formatted as displayed.
Preferences	Refer to Section 4.7.7.

### 4.7.7 Preferences

The Preferences Menu allows the user to adjust the directory settings, logged data format and the colour scheme settings. It can be accessed through the **Options Menu** in most windows.

#### Directory Settings

The operator can specify/select where to save the parameter lists, logged data and real time plots.

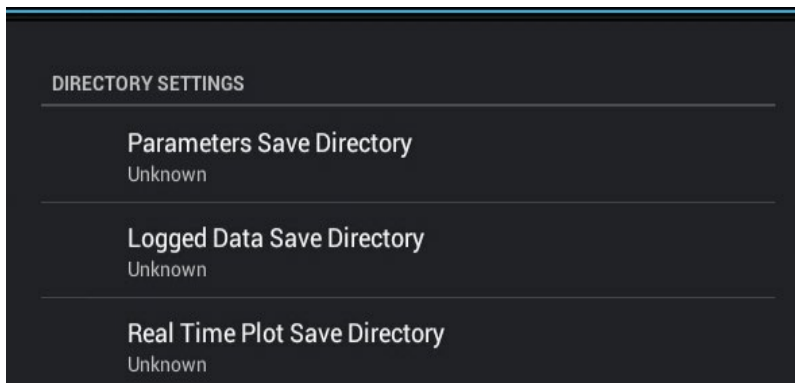

Figure 43 – Directory Settings

#### Logs Format

When downloading logged data, the parameters can be displayed on one line or each parameter on a separate line.

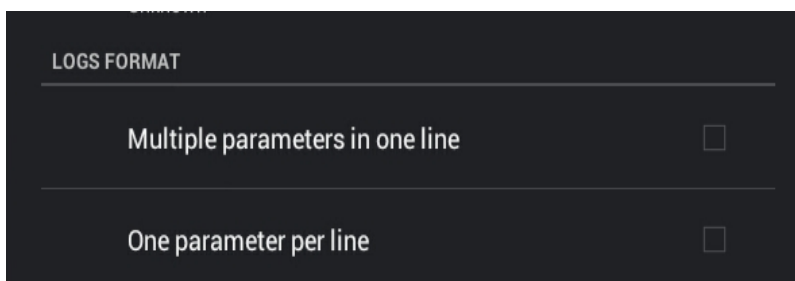

Figure 44 – Logs Format

## Colour Theme Settings

Allows the user to choose a colour scheme for the remote screen: Matrix, Classic, Emacs or Custom.

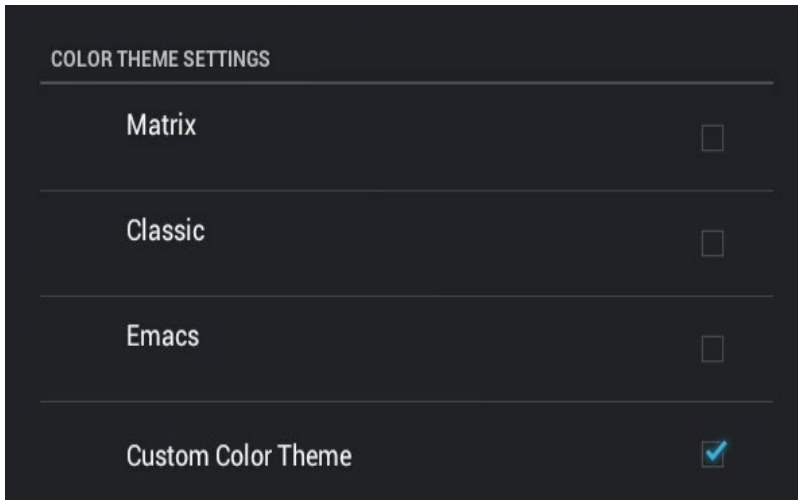

Figure 45 – Colour Theme Settings



## 5. Calibration

The following sections describe how to calibrate the zero and span points of the instrument as well as giving a brief overview of the calibration system.

**Main Menu → Calibration Menu** (refer to Section 3.4.10 for information on menu items).

### 5.1 Overview

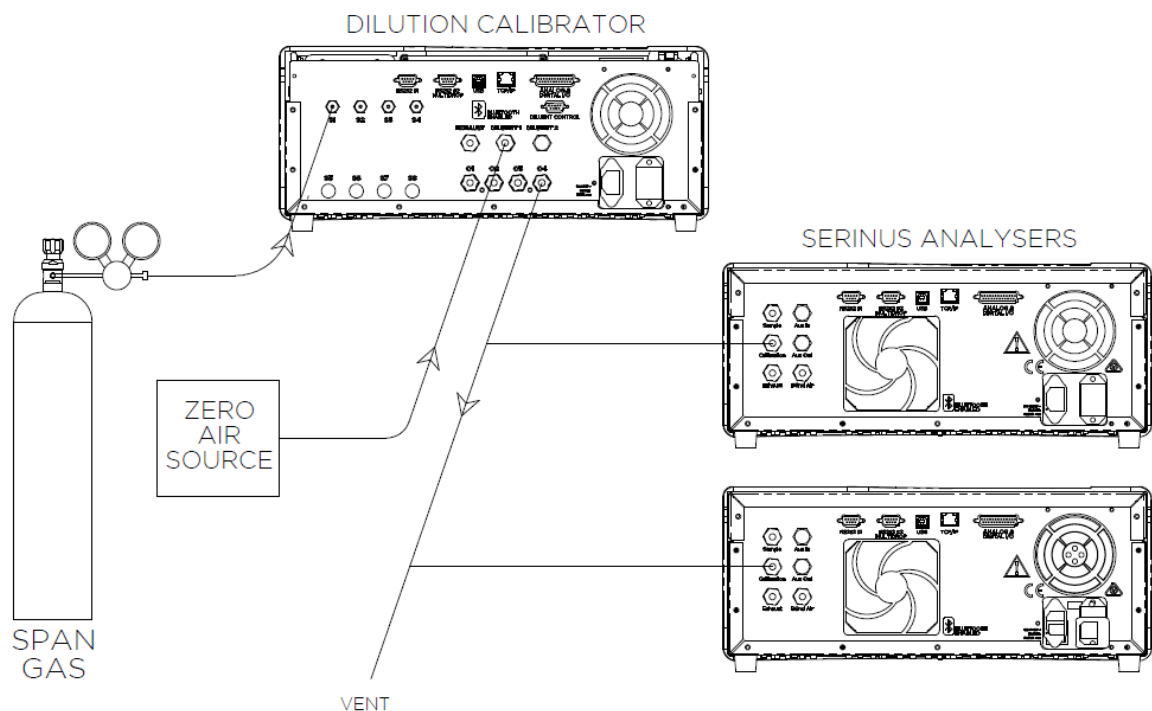

**Figure 46 – Example of a Calibration System**



#### CAUTION

All calibration gases must be supplied at ambient pressure to avoid damaging the instrument. If direct gas cylinder connection is required, high pressure Zero/Span options can be installed at time of ordering.

The calibration chapter consists of a:

- General discussion of calibration.
- Description of the pressure calibration procedure.
- Description of the Zero/Span precision check and calibration procedures.
- Description of the multipoint precision check procedure.

The Serinus 31 analyser is a precision measuring device which must be calibrated against a known source of CO<sub>2</sub> (e.g. a certified gas cylinder).

There are several different types of checks/calibrations performed:

- Level 1 Calibration – A simplified two-point instrument calibration used when instrument linearity does not need to be checked or verified. This check is typically performed on a monthly basis. Adjustments to the instrument response can only be made when performing level 1 calibration.
- Level 2 Calibration – A simple check of the instrument's response. Level 2 checks may be performed using non-certified reference sources and are most often used as a performance monitoring tool. The instrument may not be adjusted
- Multipoint precision check – A series of calibration points, typically covering zero and 5 up-scale points, measured using a certified reference atmosphere and covering the instruments FS measurement range. These precision checks are used to determine the linearity of the instrument response across its measurement range.

In general terms, the calibration process includes the following steps:

1. Establish a reliable and stable calibration source.
2. Provide a satisfactory connection between the calibration source and the instrument.
3. Calibrate the instrument against the calibration source.

Multipoint precision check is used to establish the relationship between instrument response and pollutant concentration over the instrument's full scale range. Zero and span calibrations are frequently used to provide a two-point calibration or an indication of instrument stability and function.

**Note:** Zero calibrations are not recommended by Ecotech, but may be performed when specifically required by a user. Zero calibrations tend to mask issues that should be addressed during maintenance/service.

Regulations generally require that the instrument be span calibrated any time:

- The instrument is moved.
- The instrument is serviced.
- When changing the instruments units between volumetric and gravimetric.
- Whenever the instrument characteristics may have changed.

Regulatory agencies establish the time intervals at which the instrument must be calibrated to ensure satisfactory data for their purposes.

---

## 5.2 Pressure Calibration

---

The pressure sensors are a vital component of the instrument operation. The pressure calibration should be checked on installation or whenever maintenance is performed.

A thorough leak check must be performed prior to performing a pressure calibration (refer to Section 6.4.3).

The pressure calibration can either be a two point calibration (one point under vacuum and the other at ambient pressure) or a single ambient point calibration (when very minor adjustments are required).

**Note:** Ensure that the instrument has been running for at least one hour before any calibration is performed to ensure the instrument's stability. When performing a two point pressure calibration, it is advisable to perform the vacuum pressure calibration first.

### 5.2.1 Full Pressure Calibration

This section outlines how to perform a full pressure calibration. Using the required equipment follow the steps below to complete a full pressure calibration.

**Note:** Ensure that the instrument has been running for at least one hour before the calibration is performed.

**Note:** Ensure units of measure are the same on both the barometer and instrument.

### Equipment Required

- Barometer
- Vacuum source

### Procedure

1. Turn off the vacuum source and allow the instrument to return to ambient pressure.
2. Disconnect any external tubing connected to the rear of the instrument.
3. Open - **Main Menu** → **Calibration Menu** → **Pressure Calibration Menu** - (read note) - OK.

**Note:** This action will place the valve sequencing on hold; normal sampling will be interrupted.

4. Edit - **Vacuum Set Pt.** - (Read displayed instructions) - OK.
5. Connect a barometer to the **Sample Port** (refer to Figure 6).
6. Connect a vacuum source to **Exhaust Port** (refer to Figure 6) of instrument.
7. Wait 2-5 minutes and ensure the pressure reading on the barometer has dropped and is stable.
8. Enter the barometer reading into the instrument - Accept.
9. Read displayed instructions - OK.
10. Turn off the vacuum source and wait 1 min or until the barometer reads ambient. Disconnect the vacuum source and barometer from **Exhaust Port** and **Sample Port**.

11. Wait 2-5 min, enter the ambient barometer reading into the instrument - Accept.

**Note:** Both cell and ambient pressure sensors should now be displaying the current ambient pressure and they should be the same value within 3 torr of each other.

12. Back - **Pressure Calibration Menu** - (read note) - OK.

### 5.2.2 Ambient Point Pressure Calibration

Full pressure calibrations are generally recommended, however it is possible to calibrate only the ambient point in cases where only a minor ambient pressure adjustment is required.

**Note:** Ensure that the instrument has been running for at least one hour before any calibration is performed to ensure the instrument's stability.

**Note:** Ensure units of measure are the same on both the barometer and instrument.

#### Equipment Required

- Barometer

#### Procedure

1. Turn off the vacuum source and allow the instrument to return to ambient pressure.
2. Disconnect any external tubing connected to the rear of the instrument.
3. Open - **Main Menu** → **Calibration Menu** → **Pressure Calibration Menu** - (read note) - OK.

**Note:** This action will place the valve sequence on hold; normal sampling will be interrupted.

4. Edit - **Ambient Set Pt.** - (Read displayed instructions) - OK.
5. Disconnect any external tubing connected to the rear ports of the instrument (**Sample Port**, **Exhaust Port**, etc).
6. Wait 2-5 minutes and enter the ambient barometer reading into the instrument - Accept.

**Note:** Both cell and ambient pressure sensors should now be displaying the current ambient pressure and they should be the same value within 3 torr of each other.

7. Back - **Pressure Calibration Menu** - (read note) - OK.

---

## 5.3 Pressure Calibration (Internal Pump Option Only)

---

The internal pump requires a separate pressure calibration procedure that replaces the one used in Section 5.2.

**Note:** Ensure that the instrument has been running for at least one hour before any calibration is performed to ensure sufficient stability.

**Note:** Ensure units of measure are the same on both the barometer and instrument.

## Equipment Required

- Barometer

## Procedure

1. Disconnect any external tubing connected to the rear of the instrument.
2. Open - **Main Menu** → **Calibration Menu** → **Pressure Calibration** - (read displayed note) - OK.

**Note:** Entering this menu will switch off the internal pump and place the valve sequencing on hold; normal sampling will be interrupted.

3. Connect a barometer to the **Sample Port** (refer to Figure 6).
4. Edit - **Vacuum Set Point** - (read note) - OK.
5. Wait 2-5 minutes and ensure the pressure reading on the barometer is stable.
6. Enter the barometer reading into the instrument - Accept.
7. Read displayed instructions - OK.
8. The pump should now stop automatically. Disconnect the barometer from the **Sample Port**.
9. Wait 2-5 minutes and enter the ambient barometer reading into the instrument - Accept.

**Note:** Both cell and ambient pressure sensors should now be displaying the current ambient pressure and they should be the same value within 3 torr of each other.

10. Back - **Pressure Calibration Menu** - (read note) - OK.

---

## 5.4 Manual Background

---

A background is a measurement that is made when CO<sub>2</sub> free air is drawn through the measurement cell. The resulting measurement signal (background) will include signals unrelated to CO<sub>2</sub>. The background is an electronic baseline, it is normally run every 24 hours automatically. There is sometimes a need for the user to run a manual background.

**Note:** A manual background is recommended before commencing a multipoint precision check.

## Equipment Required

- Zero air source or scrubber (CO<sub>2</sub> free air)

## Procedure

1. Ensure a suitable zero source or scrubber is connected to the background air port (refer to Figure 6 and Section 2.3.1 ).
2. Open - **Main Menu** → **Calibration Menu**.

3. Start - **Manual Background** → **Running**.
4. Manual background will now display running and will proceed to draw scrubbed air from the background port for 4 minutes (3 minutes of fill time and 1 minute of measure). The user can press stop at any time to cancel the background. At the end of the 4 minute period a new background voltage will be recorded in the event log as well as in the **Calculation Factors Menu**.

---

## 5.5 Zero Calibration

---

Zero calibrations are used to determine the zero response of the instrument and apply an offset to the reading.

Performing a zero calibration will adjust the **Zero Offset CO<sub>2</sub>**. This offset can be checked in the **Main Menu** → **Service Menu** → **Calculation Factors Menu** and should be very close to zero. A large offset may indicate a problem with the instrument (refer to Section 7).

**Note:** Ecotech encourages regular zero precision checks; however Ecotech recommends that the zero calibration only be performed when specifically required as it may mask issues that should be addressed during maintenance/service.

A zero calibration can be performed either through the **Calibration Port**, **Background Air Port** or the **Sample Port**. Refer to the instructions outlined in the next three sections:

**Note:** Ensure the instrument has been running for at least one hour before any calibration is performed to ensure sufficient stability.

### 5.5.1 Calibration Port

#### Equipment Required

- Zero source (CO<sub>2</sub> free air)

#### Procedure

1. Ensure a suitable zero source is connected to the **Calibration port**.
2. Open - **Main Menu** → **Calibration Menu**.
3. Select - **Cal. Type** → **Manual** - Accept.
4. Select - **Zero Source** → **External** - Accept.
5. Select - **Cal. Mode** → **Zero** - Accept.
6. Allow the instrument time to achieve a stable response.
7. Enter - **Zero Calibrate CO<sub>2</sub>** - OK.
8. Select - **Cal. Mode** → **Measure** - Accept (To return to sample measure).

### 5.5.2 Sample Port

#### Equipment Required

- Zero source (CO<sub>2</sub> free air)

#### Procedure

1. Ensure a suitable zero source is connected to the **Sample Port**.
2. Open - **Main Menu** → **Calibration Menu**.
3. Select - **Cal. Type** → **Manual** - Accept.
4. Select - **Zero Source** → **External** - Accept.
5. Select - **Cal. Mode** → **Measure** - Accept.
6. Allow the instrument time to achieve a stable response.
7. Enter - **Zero Calibrate CO<sub>2</sub>** - OK.
8. Disconnect the zero source and reconnect the sample line to the **Sample Port**.

### 5.5.3 Background Air Port

#### Equipment Required

- Zero air source or scrubber (CO<sub>2</sub> free air)

#### Procedure

1. Open - **Main Menu** → **Calibration Menu**.
2. Select - **Cal. Type** → **Manual** - Accept.
3. Select - **Zero Source** → **Internal** - Accept.
4. Select - **Cal. Mode** → **Zero** - Accept.
5. Allow the instrument time to achieve a stable response.
6. Enter - **Zero Calibrate CO<sub>2</sub>** - OK.
7. Select - **Cal. Mode** → **Measure** - Accept (To return to sample measure).

---

## 5.6 Span Calibration

---

A span calibration is a calibration performed at the upper end of the instrument's measurement range. Ecotech recommends calibration at 80 % of the full scale measurement or operating range of the instrument.

A span gas can be supplied through either the **Calibration Port** or **Sample Port**. Refer to the instructions outlined in the next two sections.

**Note:** Ensure that the instrument has been running for at least one hour before any calibration is performed to ensure sufficient stability.

### 5.6.1 Calibration Port

#### Equipment Required

- Span source

#### Procedure

1. Ensure a suitable span source is connected to the **Calibration Port**.
2. If diluting the gas with a dilution calibrator, set the output concentration to 80 % of the instrument measurement range.
3. Open - **Main Menu** → **Calibration Menu**.
4. Select - **Cal. Type** → **Manual** - Accept.
5. Select - **Cal. Mode** → **Span** - Accept.
6. Let the instrument stabilise, typically 15 minutes.
7. Enter - **Span Calibrate CO2** - (Enter the span output concentration) - Accept.
8. Select - **Cal. Mode** → **Measure** - Accept (To return to sample measure).

### 5.6.2 Sample Port

#### Equipment Required

- Span source

#### Procedure

1. Ensure suitable span source is connected to the **Sample Port**.
2. If diluting the gas with a dilution calibrator, set the output concentration to 80 % of the instrument measurement range.
3. Open - **Main Menu** → **Calibration Menu**.
4. Select - **Cal. Type** → **Manual** - Accept.
5. Select - **Cal. Mode** → **Measure** - Accept.
6. Let the instrument stabilise, typically 15 minutes.
7. Enter - **Span Calibrate CO2** - (Enter the span output concentration) - Accept.
8. Disconnect the span source and reconnect the sample line to the **Sample Port**.

### 5.6.3 Manual Instrument Gain and Offset Adjustments



#### CAUTION

Manual adjustment of the Instrument Gain does not take into account the PTF correction and can lead to an incorrect calibration.



At times it may be desirable to manually adjust the instrument's gain and offset. Typically this option is only used when an instrument calibration has been corrupted and the user wishes to reset the instrument response factors prior to performing a new calibration.

To manually adjust the instrument follow the below procedure:

1. Open - **Main Menu** → **Service Menu** → **Calculation Factors Menu**.
2. Edit - **Instrument Gain** - (Adjust as required. 1 is the default) - Accept.
3. Edit - **Zero Offset CO2** - (Adjust as required. 0 is the default) - Accept.

---

## 5.7 Precision Check

---

Similar to a normal zero or span calibration, a precision check is a *Level 2 calibration* that may be performed using a non-certified reference. The instrument is supplied with a known concentration of span gas (or zero air) and the instrument's response observed. However, no adjustment to the instrument response is made during a precision check.

**Note:** Ensure that the instrument has been running for at least one hour before any calibration is performed to ensure sufficient stability.

### Equipment Required

- Span source
- Zero source

### Procedure

1. Supply the instrument with a zero source (refer to Section 5.5 for the procedure of setting up a zero, but do not do a **Zero Calibrate CO2**).
2. Observe and record the measurement from the instrument.
3. Supply the instrument with a span source (refer to Section 5.6 for the procedure of setting up a span but do not do a **Span Calibrate CO2**).
4. Observe and record the measurement from the instrument.
5. Check both readings against your local applicable standards.

If an instrument fails a span precision check (based on the users local applicable standards), perform a span calibration (refer to Section 5.6).

If an instrument fails a zero precision check (based on the users local applicable standards), resolve the issue by referring to Section 6 (Service).

---

## 5.8 Multipoint Precision Check

---

A multipoint precision check is used to determine the linear response of the instrument across its operating range. The instrument is supplied with span gas at multiple known concentrations, typically a zero point and at least five up-scale points, spread across the operating range of the

instrument. The observed concentrations are compared to expected values and the linearity of the instrument assessed against local applicable standards.

**Note:** The instrument is inherently linear and the instrument gain should **not** be adjusted at each individual point. Non-linearity indicates a problem with the instrument (refer to Section 7). Ensure that the instrument has been running for at least one hour before any calibration is performed to ensure sufficient stability.

Several methods for producing multiple known concentrations are available to use, such as connecting multiple certified gas cylinders at different concentrations. However, Ecotech strongly recommends the use of a dilution calibrator and a certified cylinder of CO<sub>2</sub> at an appropriate concentration.

1. Connect your calibration system to the **Calibration Port** of the instrument (Ecotech recommends the Serinus Cal 1000 as a minimum, refer to Figure 46).
2. Generate and record the displayed span concentrations for (at least) six stepped points (of known concentrations) evenly spaced across the instruments measurement range (refer to the example below).
3. Then using a program such as MS Excel, create an X Y scatter plot of expected concentration versus the recorded instrument response and use linear regression to calculate the line of best fit and the correlation factor (R<sup>2</sup>) – refer to the users local applicable standards.

Example for an instrument measurement range of 3000 ppm:

- a. For the 1st concentration, set the gas dilution calibrator to supply **3000 ppm** CO<sub>2</sub> gas to the instrument.
- b. Allow the instrument to sample the calibration gas until a prolonged stable response is achieved (the amount of time this takes is impacted by the calibration setup). Record the instrument response.
- c. Repeat the above steps using concentrations of **2400 ppm, 1920 ppm, 1440 ppm, 960 ppm, 480 ppm** and a **Zero** point.

**Note:** To highlight hysteresis errors, it is advisable to run the multipoint check in both descending and ascending order - refer to your applicable local standards.

- d. Graph the results and use linear regression to determine a pass or fail as per your applicable local standards.
4. The linear regression equation will be displayed.

$$y = mx + c$$

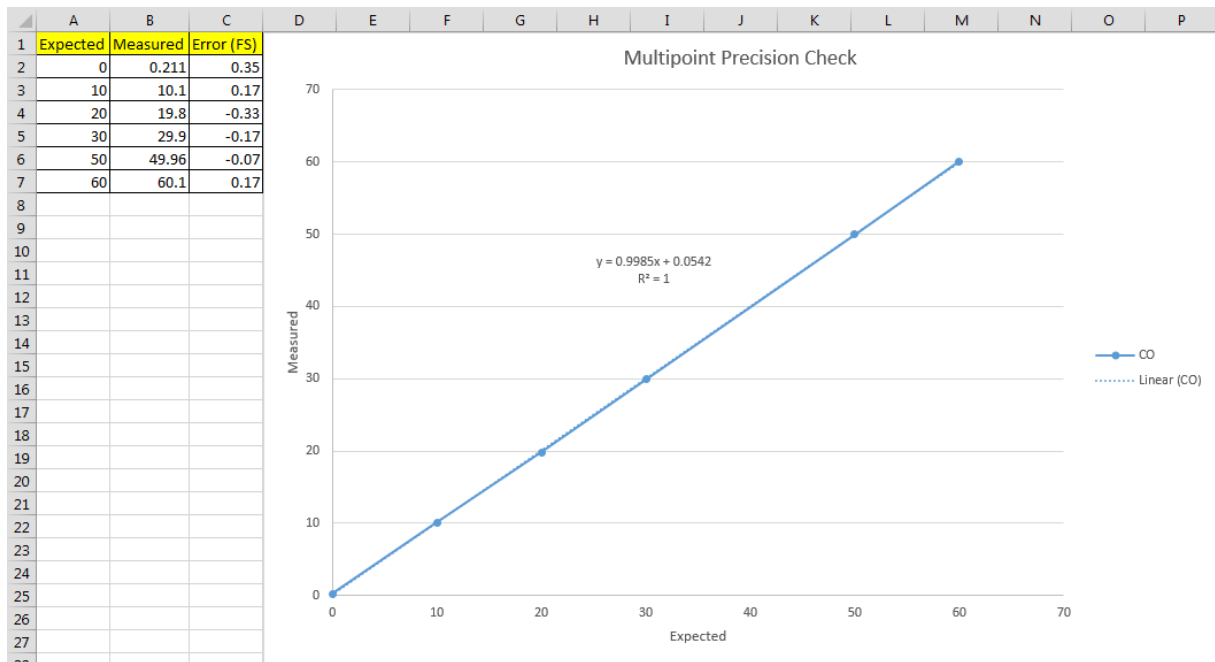

**Figure 47 – Excel Graph of Multipoint Precision Check**

5. The following is a guide to approximate expected good results.
  - a. The gradient (m) falls between 0.98 and 1.02.
  - b. The intercept (b) lies between -2 and +2.
  - c. The correlation ( $R^2$ ) is greater than 0.99.
6. If unsatisfactory results are observed refer to Section 7.

## 5.9 Flow Calibration (Internal Pump Option Only)

This procedure calibrates the rate of the flow generated by the internal pump. The following procedure must be performed if the instrument:

- After a service or repair.
- When the external flow check has found the flow to be outside normal range.
- When a new pump has been installed.
- When the instrument is reset to factory defaults.

### Equipment Required

- Calibrated Flow Meter

### Procedure

1. Disconnect any external tubing connected to the rear ports of the instrument (**Sample Port**, **Exhaust Port**, etc.).
2. Open - **Main Menu** → **Calibration Menu** → **Flow Calibration Menu**.

3. Off - **Internal Pump** → **Off**.
4. Wait for the **Sample Flow** to become stable around 0 ( $\pm 0.01$  slpm).
5. Set - **Cal. Zero** - Yes (Calibration of your zero point).
6. Connect a calibrated flow meter to the Sample Port.
7. On - **Internal Pump** → **On**.
8. Edit the **Coarse** and **Fine** pots until the flow meter reads the desired instrument **Sample Flow** rate (**Set Point**).

**Note:** Adjust the **Fine** pot to 253, adjust the **Coarse** to be as close as possible to desired reading and use **Fine** pot to make it exact.

9. Edit - **Cal. Point** - (Enter the reading from the flow meter) - Accept.
10. Select - **Pump Control** → **START** - Accept.
11. Leave for up to five minutes to return to normal operation. If instrument doesn't return to normal there may be a blockage (refer to Section 7).
12. Remove flow meter and reconnect external tubing.
13. Back - **Flow Calibration Menu** - (Read note) - OK

---

## 5.10 High Pressure Zero/Span Valve (Option)

---

If the instrument was ordered with this option, the internal pressurised calibration valves will already be installed within the instrument as either a zero or span calibration source, thus no other internal connections need to be made.

**Note:** Before using a high pressure span or zero as a source for calibrating the instrument, please check the local regulatory requirements. This is generally only be used as an operational check of the instrument's zero point and single span point (recommended as 80 % of full scale).

## 5.10.1 Single Pressurised Calibration Option

### Set-Up of Single Calibration Option

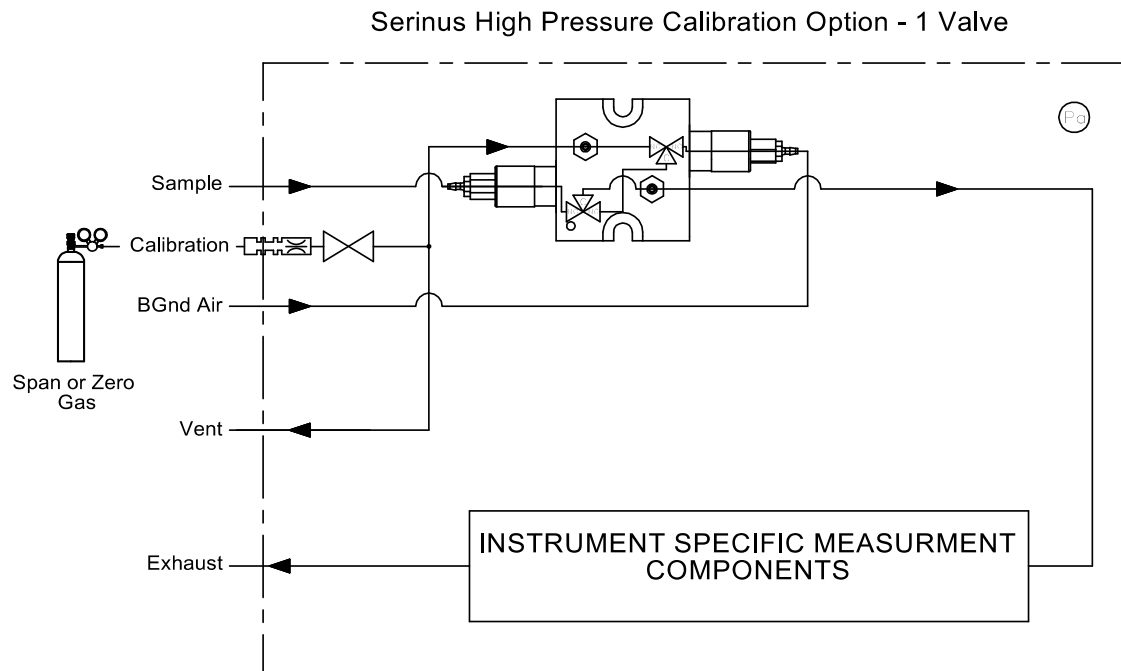

**Figure 48 – Single High Pressure Calibration Option**

When using the pressurised calibration option, either a high pressure zero or span cylinder (depending on the option you have ordered) should be connected to the **Calibration Port**.

#### Equipment Required

- Calibrated Flow Meter
- Gas Cylinder and Accessories

#### Procedure

1. Ensure the gas cylinder is fitted with an appropriate gas regulator with a shut off valve.
2. Connect a ¼" line of stainless steel tubing between the gas cylinder and the instruments **Calibration Port**.

**Note:** This connection may need to be retightened during this operation.

3. Open the cylinder main valve and adjust the regulator to 15 psig.
4. Open the regulator's shutoff valve and test for leaks:
  - a. Pressurise the line.
  - b. Close the cylinder main valve.
  - c. If pressure drops by more than 2 PSI over five minutes, check the connections and retest.
  - d. Open cylinder main valve.

5. Temporarily place a flow meter on the **Vent Port**.
6. Open - **Main Menu** → **Calibration Menu**.
7. Select - **Cal. Type** → **Manual** - Accept.
8. Select - **Cal. Mode** → **Span** or **Zero** - Accept (Depending on the option installed).

**Note:** When using the high pressure zero option, ensure **Zero Source** is set to **External**.

9. Adjust the regulator pressure until the flow meter on the **Vent Port** is between 0.5 and 1 slpm. This flow rate is you excess calibration gas.

**Note:** Do not exceed a pressure of 2 bars, this can damage the instrument and cause gas leakage.

### Return to Normal Operation

1. Select - **Cal. Mode** → **Measure** - Accept. (To return to sample measure).
2. Remove the flow meter on the **Vent Port** and connect a vent line.
3. Reconnect the instrument fittings and return to the original set-up.

The instrument is now in normal operation mode. When either zero or span calibration is initiated (depending on which option has been installed) the instrument will automatically open the valves to run a pressurised calibration.

### 5.10.2 Dual Pressurised Calibration Option

#### Set-Up of Dual Calibration Option

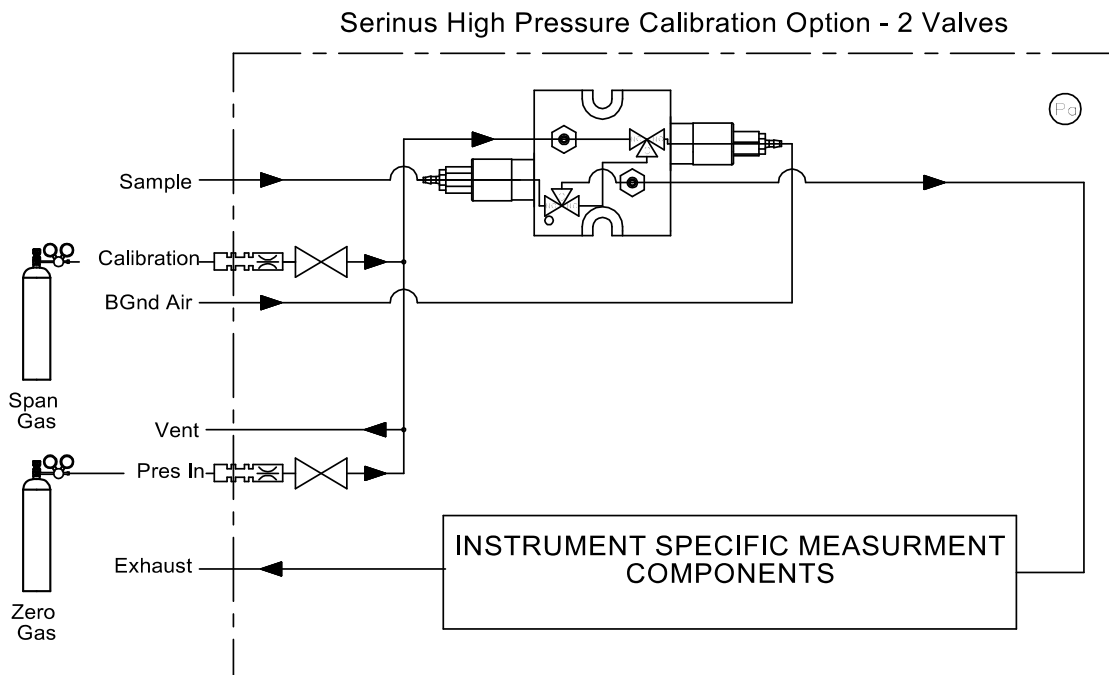

Figure 49 – Dual High Pressure Calibration Option

When using the dual pressurised calibration option, a high pressure zero cylinder should be connected to the **Pres In Port** and a high pressure span cylinder connected to the **Calibration Port**.

### Equipment Required

- Calibrated Flow Meter
- Gas Cylinder of Zero air and Accessories
- Gas Cylinder of CO<sub>2</sub> and Accessories

### Procedure

1. Ensure the gas cylinder is fitted with an appropriate gas regulator with a shut off valve.
2. Connect a ¼" line of stainless steel tubing between the appropriate gas cylinders and the instrument's **Pres In Port** and **Calibration Port**.

**Note:** This connection may need to be retightened during this operation.

3. Open the cylinder main valve and adjust the regulator to 15 psig.
4. Open the regulator's shutoff valve and test for leaks:
  - a. Pressurise the line.
  - b. Close the cylinder main valve.
  - c. If pressure drops by more than 2 PSI over five minutes, check the connections and retest.
  - d. Open cylinder main valve.
5. Temporarily place a flow meter on the **Vent Port** (This port is now used as the high pressure calibration vent for both span and zero).
6. Open - **Main Menu** → **Calibration Menu**.
7. Select - **Cal. Type** → **Manual** - Accept.
8. Select - **Cal. Mode** → **Zero** - Accept.

**Note:** When using the high pressure zero option, ensure **Zero Source** is set to **External**.

9. Adjust the regulator pressure until the flow meter on the **Vent Port** is between 0.5 and 1 slpm. This flow rate is you excess calibration gas.

**Note:** Do not exceed a pressure of two bars, this can damage the instrument and cause gas leakage.

10. Select - **Cal. Mode** → **Span** - Accept.
11. Adjust the regulator pressure until the flow meter on the **Vent Port** is between 0.5 and 1 slpm. This flow rate is you excess calibration gas.

**Note:** Do not exceed a pressure of two bars, this can damage the instrument and cause gas leakage.

### Return to Normal Operation

1. Select - **Cal. Mode** → **Measure** - Accept. (To return to sample measure).

2. Remove the flow meter on the **Vent Port** and connect a vent line.
3. Reconnect the instrument fittings and return to the original set-up.

The instrument is now in normal operation mode. When either zero or span calibration is initiated the instrument will automatically open the valves to run a pressurised calibration.



## 6. Service

### 6.1 Additional Safety Requirements for Service Personnel

In addition to Safety Information stated previously, service personnel are also advised of the following:

- Documentation must be consulted in all cases where caution symbol is marked, in order to find out the nature of the potential hazards and any actions which have to be taken to avoid them. Refer to Table 1 – Internationally Recognised Symbols.
- Do not energise the instrument until all conductive cleaning liquids, used on internal components, are dried up.
- Do not replace the detachable mains supply cord with an inadequately rated cord. Any mains supply cord that is used with the instrument must comply with the safety requirements (250 V / 10 A minimum requirement).

### 6.2 Maintenance Tools

To perform general maintenance on the Serinus 31 the user may require the following equipment:

- Customizable Test Equipment Case PN: H070301
- Digital Multimeter & Leads (DMM) PN: E031081 & E031082
- Barometer PN: E031080
- Flow Meter (Select Range)  
Range: 50 sccm to 5000 sccm PN: ZBI-200-220M
- Minifit Extraction Tool PN: T030001
- Orifice/Sintered Filter Extraction Tool PN: H010046
- Orifice/Sintered Filter Insertion Tool PN: T030015
- Leak Test Jig PN: H050069
- Computer/Laptop and Connection Cable for Diagnostic Tests
- 1.5 mm Hex Key
- Assortment of 1/4" and 1/8" Tubing and Fittings
- Zero Air Source
- Span Gas Source



**Figure 50 – Minifit Extraction Tool – (PN: T030001)**

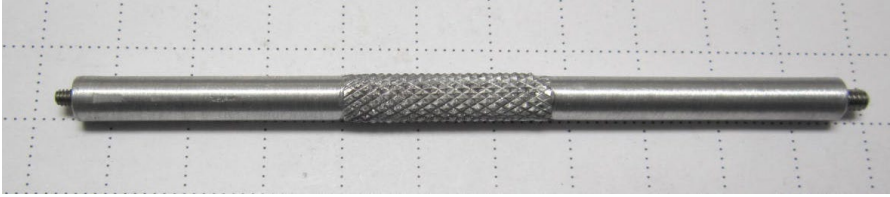

**Figure 51 – Orifice/Sintered Filter Removal Tool – (PN: H010046)**

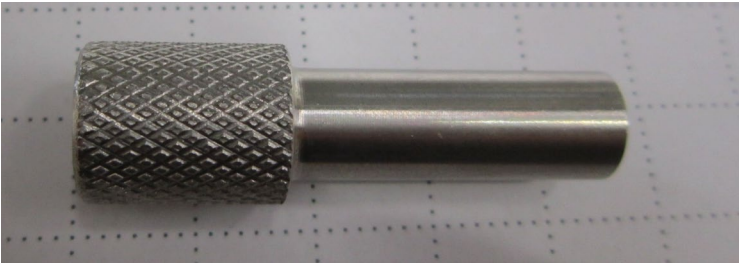

**Figure 52 – Orifice/Sintered Filter Insertion Tool – (PN: T030015)**

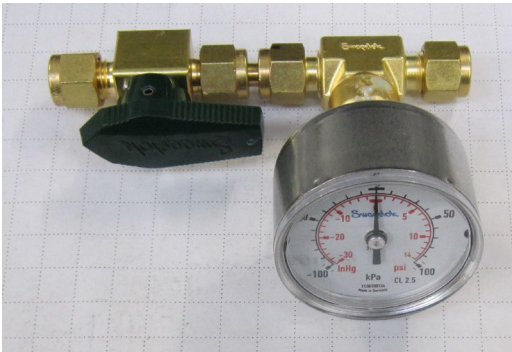

**Figure 53 – Leak Test Jig – (PN: H050069)**



**Figure 54 – Air Monitoring Test Equipment Kit (AMTEK) – Customisable**

## 6.3 Maintenance Schedule

The maintenance intervals are determined by compliance standards that differ in various regions. The following is recommended by Ecotech as a guide. Compliance with local regulatory or international standards is the responsibility of the user.

**Table 6 – Maintenance schedule**

Interval *	Task performed	Section
Weekly	Check inlet particulate filter, replace if full/dirty	6.4.1
	Check sample inlet system for moisture or foreign materials. Clean if necessary	
	Perform precision check	5.7
	Check instrument status light is ok (green)	
Monthly	Perform leak check	6.4.3
	Check fan filter, clean if necessary	6.4.2
	Perform span calibration	5.6
	Check background zero supply (scrubber), replace if necessary	
6 Monthly	Check date and time is correct	3.4.8
	Perform multipoint precision check	5.8
Yearly	Replace sintered filter and orifice in measurement cell (only if necessary)	6.4.4
	Replace sintered filter and orifice in Aux In port (only if necessary)	
	Trim pot tuning procedure	6.4.5
	Perform pressure check	6.4.7

\* Suggested intervals for maintenance procedure are a guide only and may vary with sampling intensity and/or environmental conditions.

## 6.4 Maintenance Procedures

### 6.4.1 Particulate Filter Replacement

Contamination of the particulate filter can result in degraded performance of the instrument, including slow response time, erroneous readings, temperature drift and various other problems.

1. Turn off the vacuum source and allow the instrument to return to ambient pressure.
2. Slide open the lid of the instrument to access the particulate filter (located in front right hand corner). Unscrew the filter retaining ring (bright blue) by turning it counter-clockwise.
3. Remove the sealing cap from the filter base (refer to Figure 55).

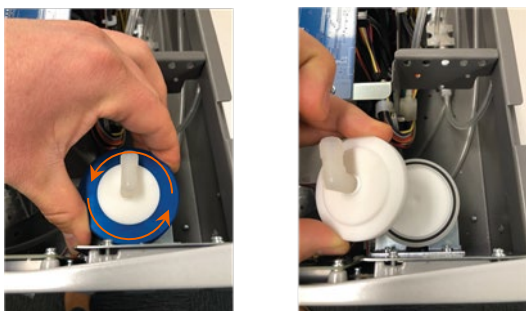

**Figure 55 – Removing the Plunger**

4. Remove the old particulate filter paper, wipe down the sealing cap with a damp cloth, dry and insert a new filter.
5. Replace the sealing cap, screw on the filter retaining ring and reconnect the pump.
6. Slide close the lid of the instrument and perform a leak check (refer to Section 6.4.3).

#### **6.4.2 Clean Fan Filter**

The fan filter is located on the rear of the instrument. If this filter becomes contaminated with dust and dirt it may affect the cooling capacity of the instrument.

1. Remove outer filter casing and filter.
2. Clean filter with water and wring dry or shake vigorously.
3. Reinstall filter and filter casing.



**Figure 56 – Removing the Fan Filter**

#### **6.4.3 Leak Check**

##### **Equipment Required**

- Vacuum Source (Pump)
- Leak Test Jig (PN: H050069)
- Kynar 1/4" Blocker Nuts
- 5/8" Spanner
- 9/16" Spanner

**Note:** Ensure that the instrument has been running for at least one hour before this procedure is performed.

## Procedure

1. Turn off the vacuum source and allow the instrument to return to ambient pressure.
2. Disconnect any external tubing connected to the rear of the instrument.
3. Connect the leak check jig to the Exhaust Port of the instrument.



Figure 57 – Leak Test Jig on Exhaust

4. Connect a vacuum source to the shut off valve ensuring the shut off valve is in the open position.
5. Block the instrument's **Sample**, **Calibration** and **Background Air** Ports with Kynar 1/4" blocker plugs.
6. Open - **Main Menu** → **Service Menu** → **Diagnostics Menu** → **Valve Menu**.
7. Disable - **Valve Sequencing** → **Disabled**.
8. Close - **Sample/Cal** → **Closed**.
9. Close - **Internal Zero/Cal** → **Closed**.
10. Close - **Pressurized Zero (OPT)** → **Closed**.
11. Close - **Pressurized Span (OPT)** → **Closed**.
12. Close the shut off valve and record the vacuum indicated on the leak test jig. Wait for three minutes and observe the gauge on the leak test jig. It should not drop more than 5 kpa. If it has, a leak is present within the sample cycle of the instrument.
13. Open - **Sample/Cal** → **Open**.
14. Open the shut off valve and allow the vacuum source to evacuate the pneumatics.
15. Close the shut off valve and record the vacuum indicated on the leak test jig. Wait for three minutes and observe the gauge on the leak test jig. It should not drop more than 5 kpa. If it has, a leak is present within the zero cycle of the instrument.
16. Open - **Internal Zero/Cal** → **Open**.
17. Open the shut off valve and allow the vacuum source to evacuate the pneumatics.

18. Close the shut off valve and record the vacuum indicated on the leak test jig. Wait for three minutes and observe the gauge on the leak test jig. It should not drop more than 5 kpa. If it has, a leak is present within the span calibration cycle of the instrument.
19. If the instrument did not leak, skip to step 22.
20. Inspect the instrument's plumbing looking for obvious damage. Check the condition of fittings, particulate filter housing plus the O-rings.
21. When the location of the leak has been determined, repair and re-run the leak check procedure.
22. Inspect the tubing again ensuring the tubing is cleanly connected to the fittings and that the internal Teflon lining has not been kinked or crumpled.
23. Remove the leak check jig and Kynar blocking nuts.
24. Open - **Main Menu → Service Menu → Diagnostics Menu → Valve Menu.**
25. Enable - **Valve Sequencing → Enabled.**

#### 6.4.3.1 Leak Check (Internal pump option)

##### Equipment Required

- Barometer
- Kynar ¼" Blocker Nuts
- 5/8" Spanner
- 9/16" Spanner
- 7/16" Spanner

##### Procedure

**Note:** Ensure that the instrument has been running for at least one hour before this procedure is performed.

1. Disconnect all external tubing connected to the rear ports of the instrument.
2. Open - **Main Menu → Service Menu → Diagnostics Menu → Internal Pump Menu.**
3. Select - **Pump Control → Manual** - Accept.
4. Edit - **Coarse** - (set to 255) - Accept.
5. Edit - **Fine** - (set to 255) - Accept.
6. Open - **Main Menu → Service Menu → Diagnostics Menu → Valve Menu.**
7. Disable - **Valve Sequencing → Disabled.**
8. Turn **Off** all the valves.
9. Block the **Sample Port** with a barometer.
10. Allow the internal pump to time to evacuate the pneumatic system (the time required will depend on the condition of the pump 1 to 2 minutes).
11. Open - **Main Menu → Service Menu → Diagnostics Menu → Internal Pump Menu.**
12. Toggle Off - **Internal Pump → Off.**

13. Note the value on the barometer. Wait for three minutes, the value should not drop more than 5 kpa (37.5 torr). If the leak check passed skip to step 17.
14. If there was a leak, toggle the pump on again and repeat step 10-12, but this time before toggling off the pump turn the manual stop valve 90° located inside the chassis just before the inlet of the flow block. This will isolate the internal pump. If the leak check passed skip to step 17.
15. Inspect the instrument's plumbing looking for obvious damage. Check the condition of fittings, particulate filter housing plus the O-rings.
16. If the leak is still present divide up the pneumatic system into discrete sections to locate the leak (refer to Section 9.5). When the location of the leak has been determined repair and then rerun the leak check procedure.
17. Slowly remove the barometer from the **Sample Port**, allowing the instrument to return to ambient pressure.
18. Open - **Main Menu** → **Service Menu** → **Diagnostics Menu** → **Valve Menu**.
19. Enable - **Valve Sequencing** → **Enabled**.
20. Open - **Main Menu** → **Service Menu** → **Diagnostics Menu** → **Internal Pump Menu**.
21. Select - **Flow Control** → **Start** - Accept.

#### 6.4.4 Sintered Filter/Orifice Replacement

##### Equipment Required

- Orifice/filter removal tool (PN: H010046)
- 9/16" Spanner

##### Procedure

1. Remove the vacuum source from the **Exhaust Port**.
2. Unscrew the Kynar nut from the fitting (anti-clockwise) on the **Measurement Cell** (refer to Figure 58).

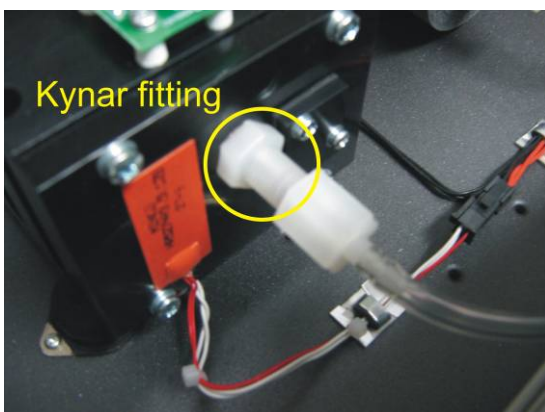

**Figure 58 – Kynar Fitting Containing Orifice and Sintered Filter**

3. Remove the spring to gain access to the orifice.
4. Use the orifice/sintered filter extraction tool to screw into the orifice (clockwise) and gently pull the orifice out of the fitting.

5. Repeat the process again for the sintered filter using the other end of the orifice/sintered filter extraction tool.
6. The orifice can now be cleaned or exchanged as required. The sintered filter is normally replaced.
7. Replace the sintered filter then the orifice back into the fitting with the orifice/filter extraction tool.
8. Replace the Kynar nut back into the **Measurement Cell**.
9. Perform a leak check (refer to Section 6.4.3).
10. Reconnect the vacuum source to the **Exhaust Port**.

### 6.4.5 Trim Pot Tuning Procedure

The following procedure must be performed to ensure the Serinus 31 receives an optimal signal. If this procedure is not performed, the Serinus 31 is likely to produce unstable results. If the **Input Pot** reads less than 155 or greater than 190 while sampling zero air (refer to Section 3.4.15), this is an indication that this procedure needs to be performed.

**Note:** The Instrument needs to have been powered up for 2 hours or more and have purge air connected to the Aux In port, before following this procedure.

#### Equipment Required

- Pot Adjustment tool

#### Procedure

1. Open - **Main Menu** → **Service Menu** → **Diagnostics Menu**.
2. Disable - **Control Loop** → **Disabled**.
3. Open - **Digital Pots Menu**.
4. Edit - **Input Pot** - (Adjust to 170) - Accept.
5. Adjust the trim pot on the detector assembly (refer to Figure 3) such that the **Ref. Voltage** reads  $4.05\text{ V} \pm 0.05\text{ V}$ .
6. Back - **Diagnostics Menu**.
7. Enable - **Control Loop** → **Enabled**.
8. Open - **Main Menu** → **Calibration Menu**.
9. Start - **Manual Background** → **Running**
10. After the background is complete, ensure that the Input pot reads  $170 \pm 10$ . If not, perform this procedure again.

### 6.4.6 Clean Pneumatics

The **Calibration Valve Manifold** (refer to Figure 3) will require disassembling and cleaning. Ideally the valves and the manifold should be cleaned in a sonic bath with lab detergent and distilled water. Once clean rinse with distilled water and dry with clean dry oil free air before reassembling. A leak check should be performed once the instrument is ready for operation (refer to Section 6.4.3).



**Note:** If the tubing shows signs of significant contamination, it should be replaced with new tubing. Do not clean the mirrors found within the **Measurement Cell**.

### 6.4.7 Pressure Sensor Check

Pressure checks are needed to ensure that the pressure sensor is accurately measuring pressure inside the instrument.

During normal operation ensure that the pressure and flow menu indicate the following parameters. Ambient should display the current ambient pressure at site. Cell should indicate current cell pressure depending on the pump condition and location. The cell pressure is normally about 20 torr below ambient.

#### Equipment Required

- Barometer
- Digital Multimeter (DMM)

#### Procedure

1. Open - **Main Menu** → **Analyser State Menu** → **Pressure & Flow Menu**.
2. Disconnect the exhaust and sample port connections.
3. After two to five minutes observe the pressure readings: ambient and cell. Ensure that they are reading the same  $\pm 3$  torr ( $\pm 0.4$  kPa).
4. If the readings are outside this level, perform a pressure calibration (refer to Section 5.2).

If the pressure calibration fails, the instrument may have a hardware fault. The cell pressure PCA has test points. To determine the condition of the sensor measure and the voltage on the test points, refer to Figure 59. The voltage measured across the test points is proportional to the pressure measured by the sensor. If the sensor is exposed to ambient pressure at sea level, the voltage will be around 4 volts but if the sensor is under vacuum, the voltage will be low (e.g. 0.5 volts). If the test point measures zero or negative voltage, the assembly is most likely faulty and will need to be replaced.

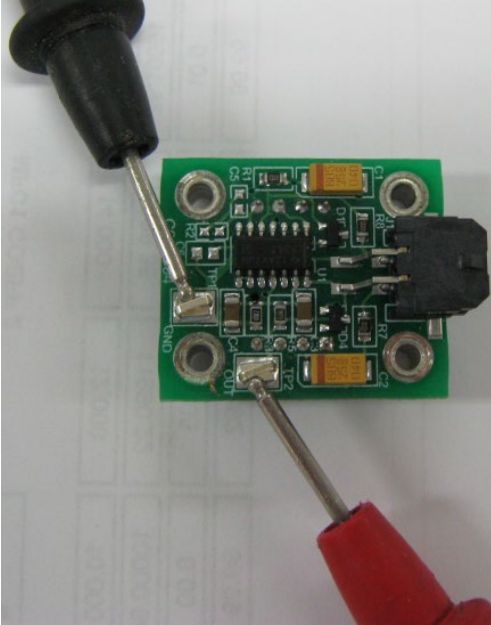

Figure 59 – Test Point Location

---

## 6.5 Bootloader

---

The Serinus Bootloader is the initial set of operations that the instruments' microprocessor performs when first powered up (similar to the BIOS found in a personal computer). This occurs every time the instrument is powered up or during instrument resets. Once the instrument boots up, it will automatically load the instruments' firmware. A service technician may need to enter the Bootloader to perform advanced microprocessor functions as described below.

To enter the Bootloader turn off the power to the instrument. Press and hold the plus key while turning the power on. Hold the Plus key until the following screen appears.

Ecotech Analyser / Calibrator V3.0 Bootloader Press '1' to enter Bootloader
---

If the instrument displays the normal start up screen, the power will need to be toggled and another attempt will need to be made to enter the Bootloader. Once successful, press 1 to enter the **Bootloader Menu**.

### 6.5.1 Display Help Screen

Once in the Bootloader screen it is possible to redisplay the help screen by pressing 1 on the keypad.

### 6.5.2 Communications Port Test

This test is very useful for fault finding communication issues. It allows a communication test to be carried out independent to any user settings or firmware revisions.

This command forces the following communication ports to output a string of characters: Serial Port RS232 #1, USB rear and Ethernet Port. The default baud rate is 38400 for the RS232 Serial Port. To initiate the test press the number 2 key from the Bootloader screen.

### 6.5.3 Updating Firmware

It is important for optimal performance of the instrument that the latest firmware is loaded. The latest firmware can be obtained by visiting Ecotech's website:

<http://www.ecotech.com/downloads/firmware>

Or by emailing Ecotech at [service@ecotech.com](mailto:service@ecotech.com) or [support@ecotech.com](mailto:support@ecotech.com)

To update the firmware from a USB memory stick, use the following procedure:

#### USB Memory Stick Update

1. Turn the instrument off.
2. Place the USB memory stick with the new firmware (ensure that firmware is placed in a folder called FIRMWARE) in the front panel USB Port.
3. Enter the Bootloader (refer to Section 6.5).
4. Select option 3 (upgrade from USB memory stick), press 3 on the keypad.
5. Wait until the upgrade has completed.
6. Press 9 on the keypad to start the instrument with the new firmware.

### 6.5.4 Erase All Settings

This command is only required if the instruments firmware has become unstable due to corrupted settings. To execute this command enter the **Bootloader Menu** (refer to Section 6.5) and press 4 on the keypad.

### 6.5.5 Start Analyser

The start analyser command will simply initiate a firmware load by pressing 9 on the keypad from the **Bootloader Menu**. It is generally used after a firmware upgrade.

This page is intentionally blank

## 7. Troubleshooting

Before troubleshooting any specific issues, Ecotech recommends ensuring the instrument has successfully completed its warm-up routine and resolving all issues listed in the instrument status menu (refer to Section 3.4.4).

**Table 7 – Troubleshoot List**

Error Message/Problem	Cause	Solution
Flow fault	Multiple possibilities	Refer to Section 7.1.
	Pump failed	Replace the internal or external pump.
	Blocked filter or orifice - only installed in external pump optioned instrument.	Replace sintered filter and orifice.
	Pressurised measurement cell	Ensure sample and zero inlets are maintained at ambient pressure (vented to atmosphere)
	Pressure sensors	Recalibrate or replace the pressure sensors.
Noisy/unstable readings	Multiple possibilities	Refer to Section 7.2.
	Calibration system error	Ensure calibration system is functioning correctly and is leak free. Ensure sufficient gas is available for instrument and an adequate vent is available for excess gas.
	Leaks	A leak in the instrument or calibration system dilutes the sample stream and causes low span readings and noise.
	Temperature unstable	<ul style="list-style-type: none"> <li>▪ A failed temperature control allows the instrument to drift with ambient temperature. Verify that both the cell and mirror temperatures are <math>50\text{ }^{\circ}\text{C} \pm 3\text{ }^{\circ}\text{C}</math>.</li> <li>▪ Chassis lid not in place causing instrument to drift with ambient temperature.</li> <li>▪ Chassis temperature drifting with ambient temperature fluctuations. Stabilise ambient temperature and remove instrument from direct ambient heating or cooling.</li> </ul>
	Hardware fault	Measurement cell internal hardware loose. Mirrors have detached or degraded.
	Commissioning error	Measurement cell travel screws are still fastened (refer to Section 2.3.4).

Error Message/Problem	Cause	Solution
	Gain too high	<ul style="list-style-type: none"> <li>▪ Leak check, repair any leaks. (refer to Section 6.4.3)</li> <li>▪ Measurement cell internal hardware loose – return to nearest service centre.</li> <li>▪ Mirrors have detached or degraded – return to nearest service centre.</li> <li>▪ Correlation wheel has leaked replace correlation wheel.</li> </ul>
Cell temperature failure	Faulty heater or temperature sensor	Refer to Section 7.3.
Mirror temperature failure	Faulty heater or temperature sensor	Refer to Section 7.4.
Instrument resetting	Multiple possibilities	<ul style="list-style-type: none"> <li>▪ Check that the instrument is not overheating.</li> <li>▪ Possibly a faulty power supply.</li> <li>▪ Corrupted firmware. Perform an ‘erase all settings’ in the <b>Bootloader Menu</b> and reload or upgrade firmware (refer to Section 6.5.4).</li> </ul>
12 Voltage supply failure	Power supply has failed	Replace power supply.
No display	Contrast adjustment required	Adjust the display contrast by pressing either of the two scrolling buttons on the front panel: <ul style="list-style-type: none"> <li>▪ Press Up scrolling button (▲) for darker contrast.</li> <li>▪ Press Down scrolling button (▼) for lighter contrast.</li> </ul>
	DC power	Verify that the power supply is providing $\pm 12$ V, +5 V DC. TP40, TP23 and TP41.
	Display	Check the interface cable between the display and the microprocessor board.
	Bad display or main controller PCA	<ul style="list-style-type: none"> <li>▪ Replace the front panel display.</li> <li>▪ Replace the main controller PCA.</li> <li>▪ Bad cables are unlikely, but if suspect it; perform a pin-for-pin continuity test using an ohmmeter.</li> </ul>
	AC power	<ul style="list-style-type: none"> <li>▪ Verify that the mains power cable is connected and the rear fan is operating.</li> </ul>
Sample pressure too high or low	Loss of pressure calibration	<ul style="list-style-type: none"> <li>▪ Perform a pressure calibration (refer to section 5.2).</li> <li>▪ Ensure particulate filter has been recently changed.</li> <li>▪ Ensure tubing is not kinked or blocked.</li> <li>▪ Ensure vacuum pump is correctly installed and operating.</li> </ul>

Error Message/Problem	Cause	Solution
Sample flow not at 1 slpm	Multiple possibilities	<ul style="list-style-type: none"> <li>▪ Check/replace sample filter.</li> <li>▪ Check pump.</li> <li>▪ Check valves.</li> <li>▪ Check/replace sintered filter.</li> <li>▪ Re-calibrate pressure sensors.</li> </ul>
Unstable flow or pressure readings	Faulty pressure sensors	<ul style="list-style-type: none"> <li>▪ Check pressure calibration.</li> <li>▪ Check calibration valve block is functioning and not blocked. If unable to diagnose problem, check the voltage across TP1 and TP2 of pressure sensor PCA. Ensure it is about 4 volts <math>\pm 0.3</math> volts. If unable to diagnose problem, it may be a noisy A/D converter, replace main controller PCA.</li> </ul>
Low span	Leaks	<ul style="list-style-type: none"> <li>▪ A leak in the instrument or calibration system dilutes the sample stream and causes low span readings and noise.</li> <li>▪ Correlation wheel has leaked replace correlation wheel.</li> </ul>
	Span calibration out	Adjust the span using the calibration procedure (refer to Section 5.6).
No response to span gas	Leaks/blockages	Leak or blockages in tubes or valves. Perform leak check and flow check and repair any leaks/blockages.
	Faulty calibration source	Ensure calibration gas is plumbed correctly and is not contaminated or has no leaks and is a certified reference gas.
	Hardware fault	Faulty Measurement cell.
	Correlation wheel leaking	Replace correlation wheel.
Zero drift	Poor temperature control	Ensure instrument is operated in a temperature controlled environment with the lid on.
	Faulty zero air	Ensure zero air source is not overly polluted.
	Leak	Perform a leak test (refer to Section 6.4.3).
Negative zero	This indicates the background air source is less efficient than the external zero supplied.	<p>Perform a leak test (refer to Section 6.4.3).</p> <p>Check the scrubber or zero air source connected to the background air port is equipped and functioning correctly.</p>

7.1 Flow Fault

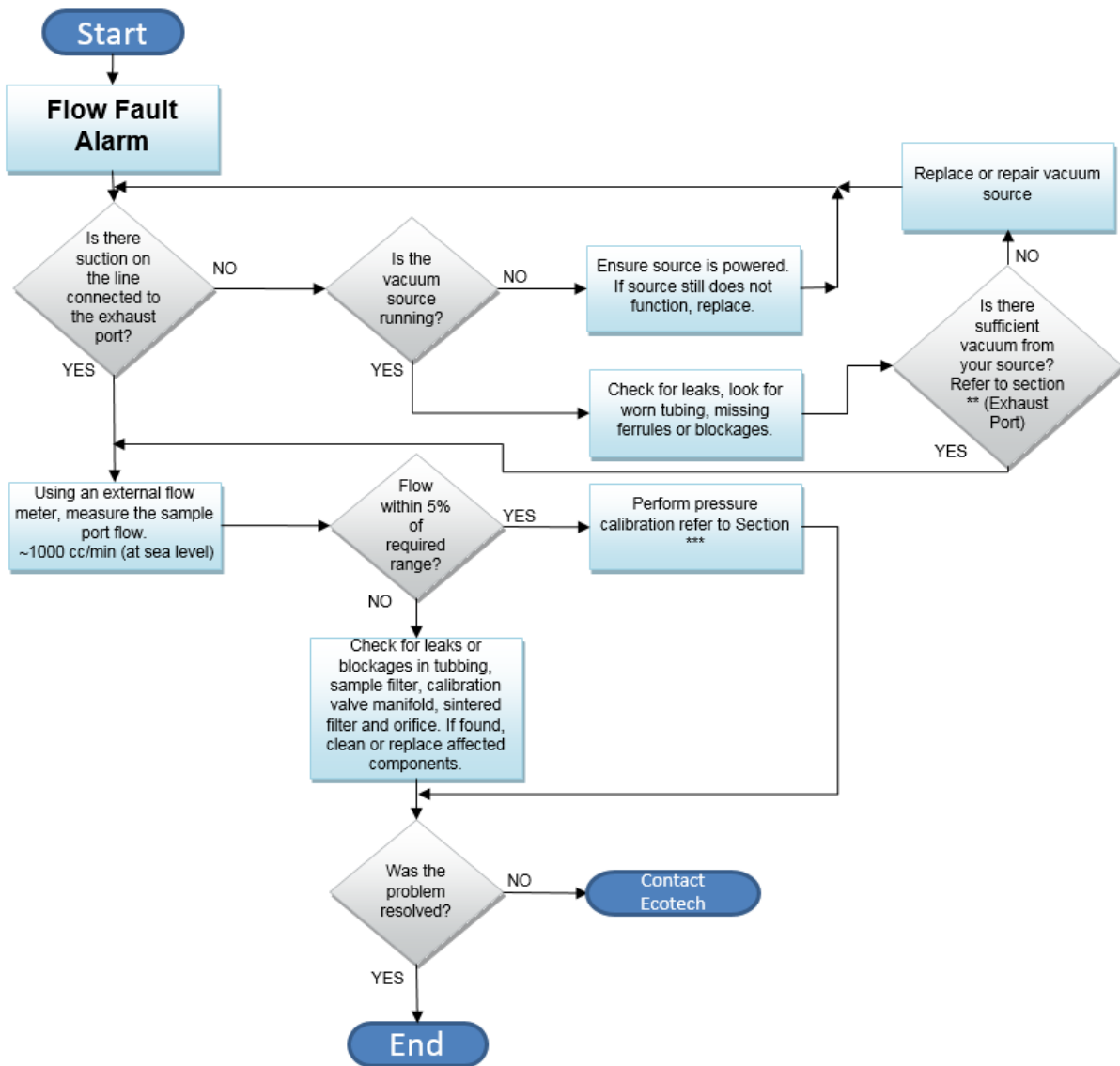

Figure 60 – Flow Fault Diagnostic Procedure

\*\* Section 2.3.1

\*\*\* Section 5.2



## 7.2 Noisy/Unstable Readings

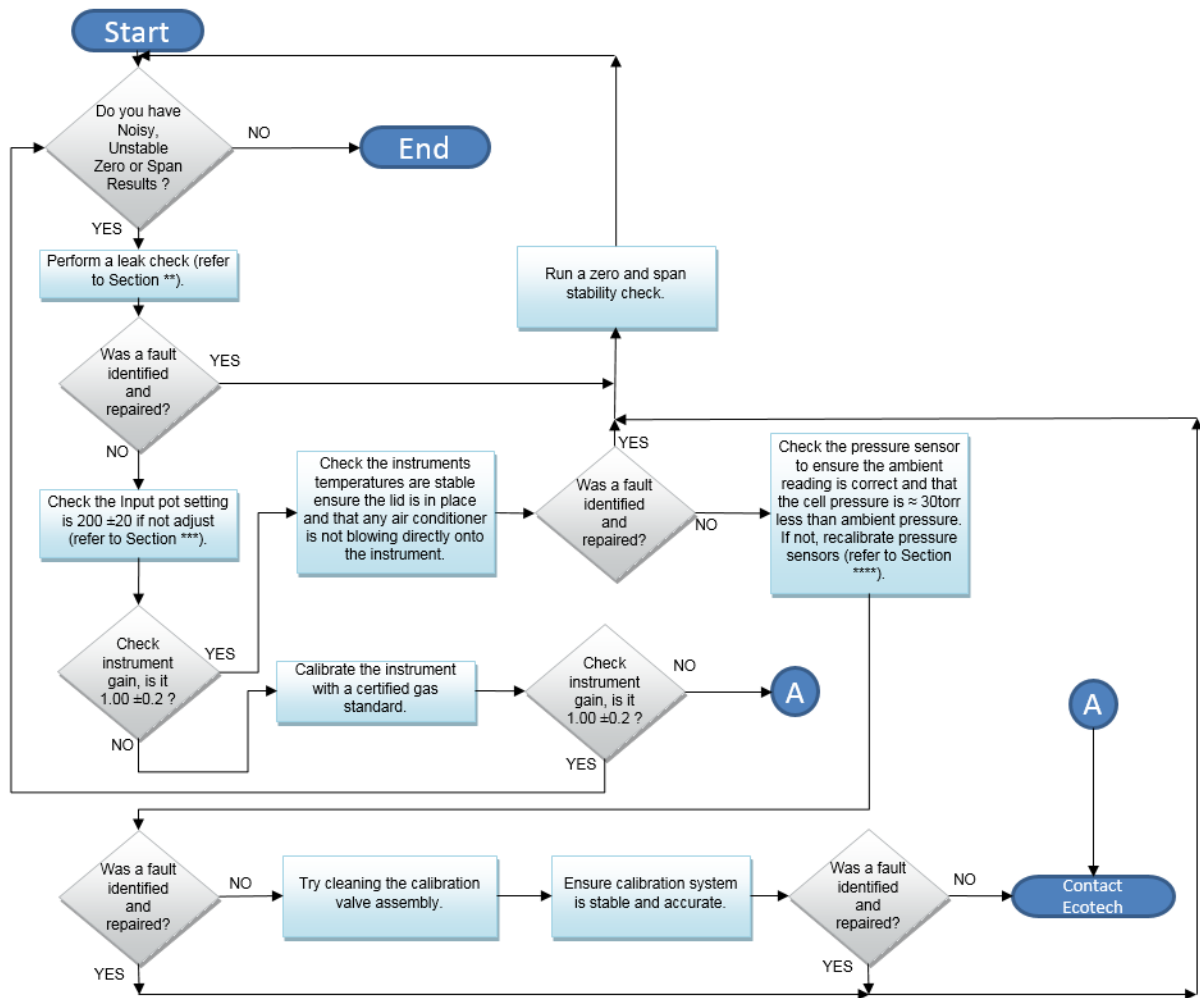

**Figure 61 – Noisy Zero or Unstable Span Diagnostic Procedure**

\*\* Section 6.4.3

\*\*\* Section 6.4.5

\*\*\*\* Section 5.2

### 7.3 Cell Temperature Failure

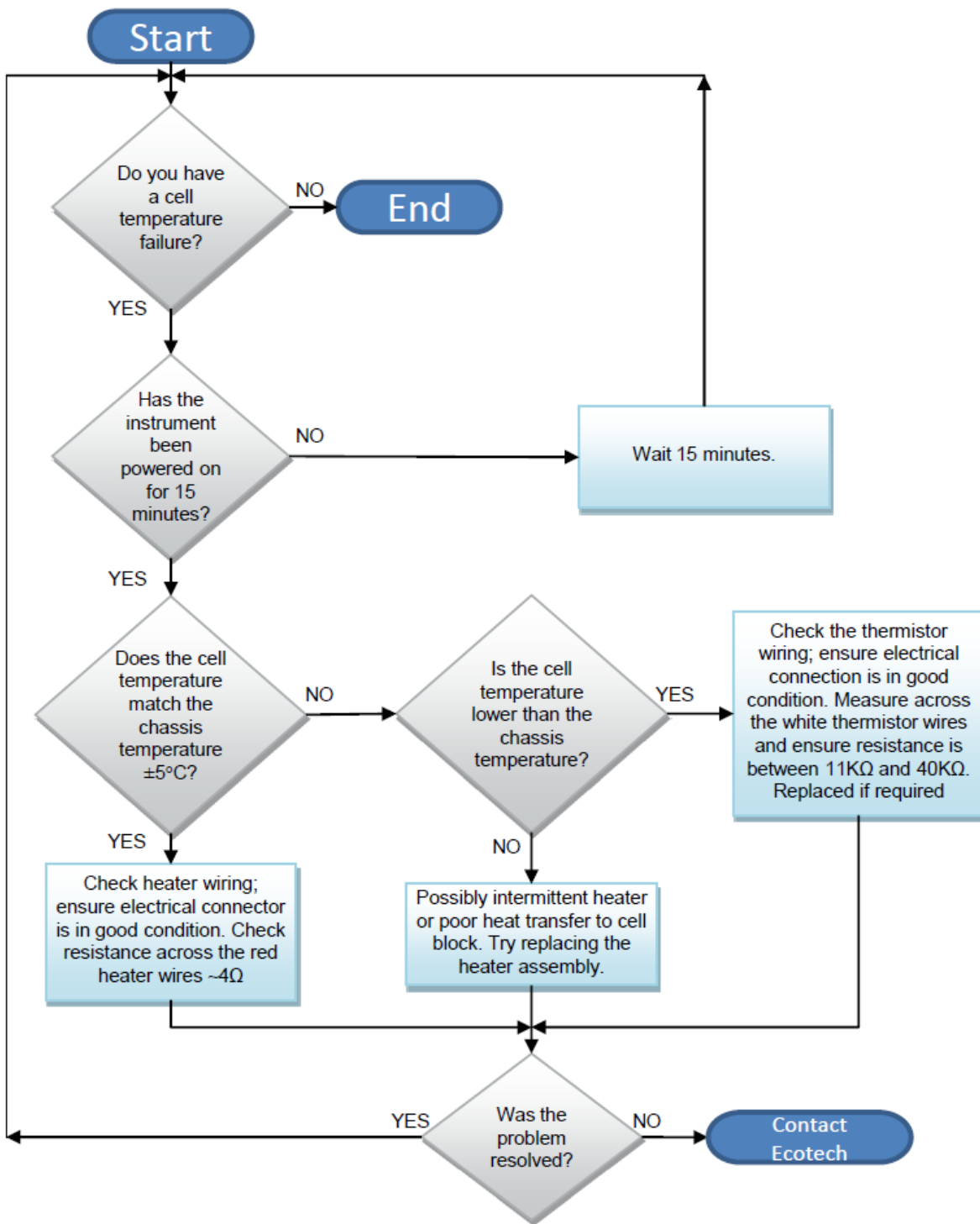

Figure 62 – Cell Temperature Failure Diagnostic Procedure

## 7.4 Mirror Temperature Failure

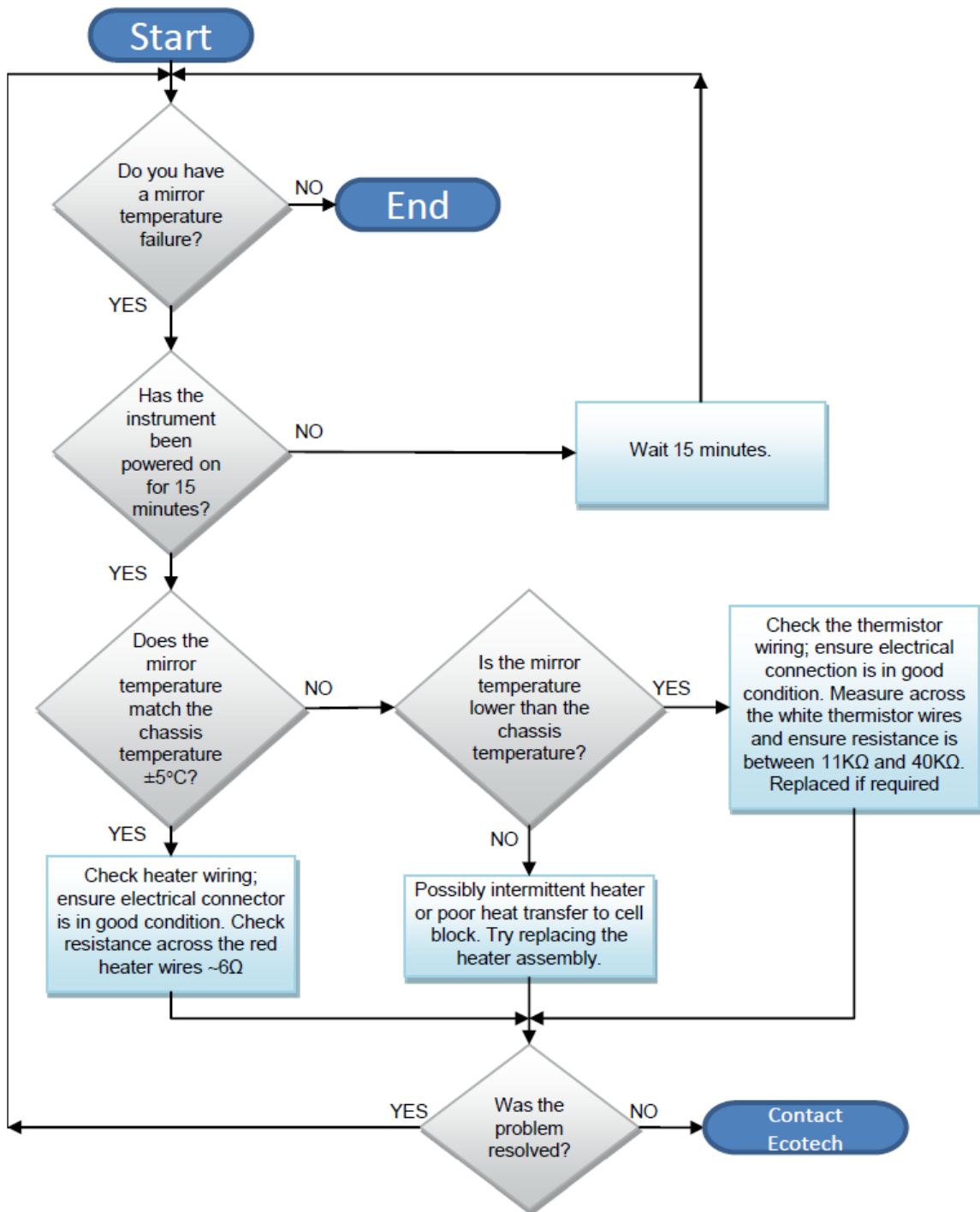

Figure 63 – Mirror Temperature Failure Diagnostic Procedure

## 7.5 USB Memory Stick Failure

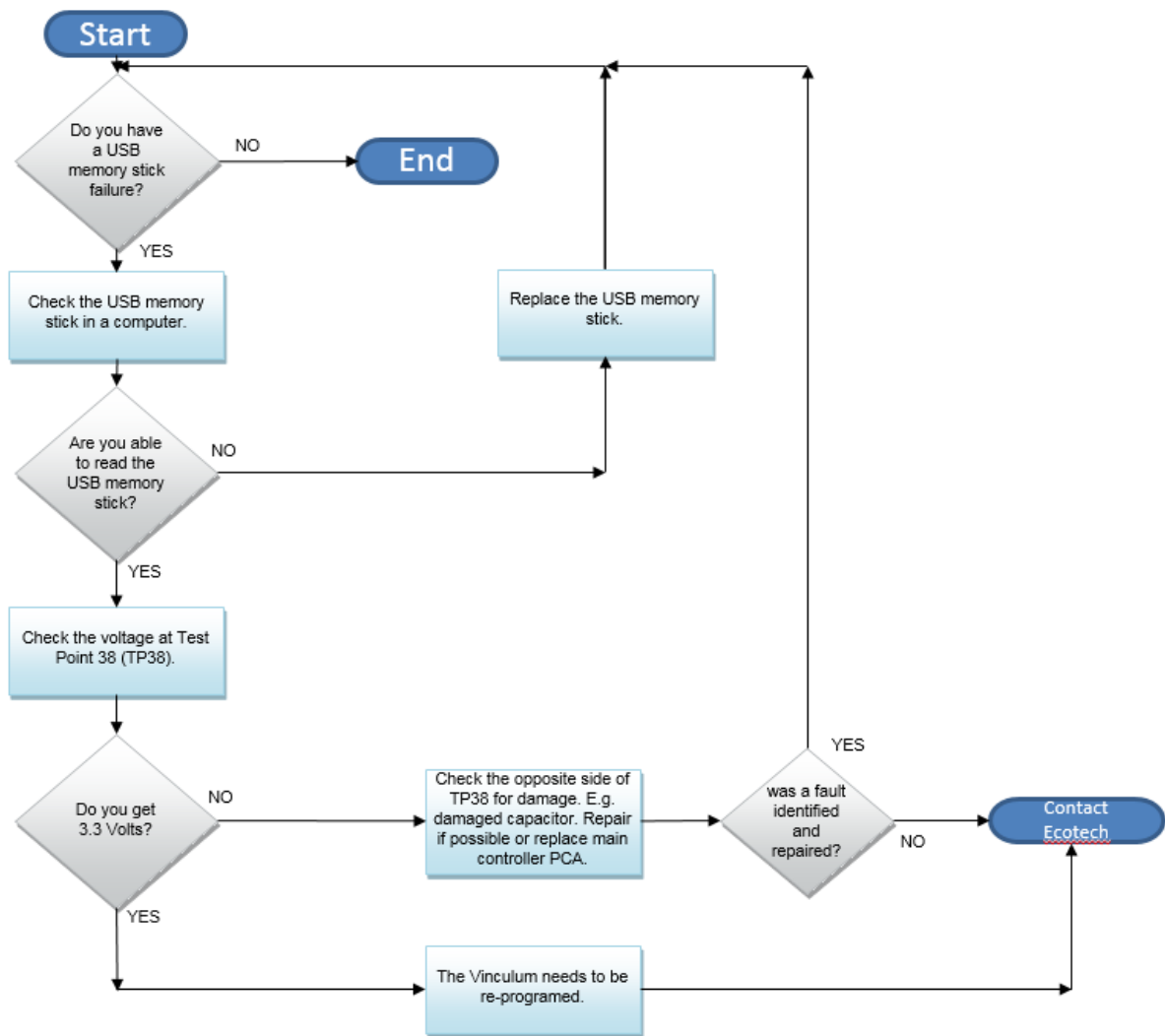

Figure 64 – USB Memory Stick Failure

---

## 7.6 Ecotech Service Support Files

---

Regular backup of the settings, parameters and data on the instruments USB memory stick is recommended.

In the event of a fault that requires Ecotech technical support, please make copies of the following files and email to [support@ecotech.com](mailto:support@ecotech.com).

### Equipment Required

- PC/Laptop

### Procedure

State the ID number, variant, board revision and firmware version of the instrument with a brief description of the problem. Take a copy of the current configuration if possible and a save of the parameters.

1. Open - **Main Menu** → **Analyser State Menu**.
2. **Variant** - (take note).
3. **Ecotech ID** - (take note).
4. **Board Revision** - (take note).
5. **Firmware Ver.** - (take note).
6. Open - **Main Menu** → **Service Menu**.
7. Save - **Save Configuration** - (CONFIG\*\*.TXT) - Accept.

**Note:** CONFIG99.TXT is the “Factory Backup” file, this is the configuration of the instrument as it left the factory. It is recommended that this file is kept unchanged but can be used as a reference backup point.

\*\* Can be any number from 0 – 98.

8. Save - **Save Parameter List** - (PARAM\*\*.TXT) - Accept.
9. Eject - **Safely Remove USB Stick** - (Follow instructions).

**Note:** PARAM99.TXT is the “Factory Backup” file, This is a snap shot of the parameters while it was under test in the factory just prior to release. It is recommended that this file is kept unchanged but can be viewed for reference.

\*\* Can be any number from 0 – 98.

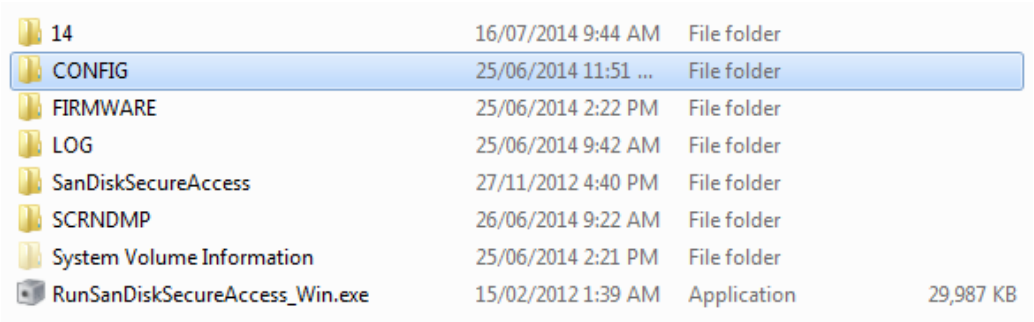

14	16/07/2014 9:44 AM	File folder	
CONFIG	25/06/2014 11:51 ...	File folder	
FIRMWARE	25/06/2014 2:22 PM	File folder	
LOG	25/06/2014 9:42 AM	File folder	
SanDiskSecureAccess	27/11/2012 4:40 PM	File folder	
SCRNDMP	26/06/2014 9:22 AM	File folder	
System Volume Information	25/06/2014 2:21 PM	File folder	
RunSanDiskSecureAccess_Win.exe	15/02/2012 1:39 AM	Application	29,987 KB

**Figure 65 – USB Memory Stick File Structure**

10. Insert the USB memory stick into your PC/Laptop computer and access the files.
11. Best practice is to email all the on the USB memory stick but if it's too large just send:
12. The CONFIG\*\*.TXT and PARAM\*\*.TXT files that are saved in the CONFIG folder.
13. The LOG files (Event Log text files) and data files (14=Year, Sub folder=month).
14. Safely Eject the USB from the PC/Laptop and return to the instrument.

## 8. Optional Extras

This section contains information on optional kits and installed options.

<b>Dual Sample Filter</b>	Refer to Section 8.1.
<b>Network Port</b>	Refer to Section 8.2.
<b>Rack Mount Kit</b>	Refer to Section 8.3.
<b>Internal Pump</b>	Refer to Section 8.4.
<b>Metric Fittings Kit</b>	Refer to Section 8.5.
<b>High Pressure Zero/Span Valves</b>	Refer to Section 8.6.

### 8.1 Dual Sample Filter (PN: E020100)

The dual filter is designed with two sample filters plumbed in parallel with a split line. This formation allows sample flow not to be affected, yet reduces the loading on each filter and therefore, the frequency with which they will need to be changed.

The dual filter option is shown in the pneumatic diagram (dashed line) and requires no operational changes to the instrument (refer to section 9.5).

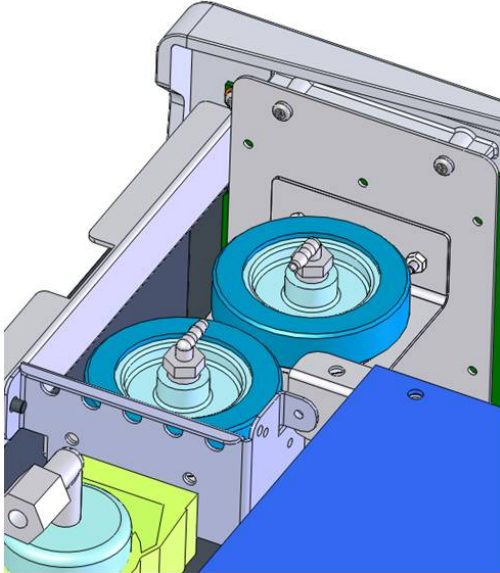

**Figure 66 – Dual Filter Option Installed**

### 8.2 Network Port (PN: E020101)

The network port option allows the user to setup and connect to a range of TCP/IP network options. If you have this option installed you need to make sure it is enabled in the **Hardware Menu** before the feature can be used.

- Refer to Section 3.4.29, for details on the network menu.
- Refer to Section 4.3, for details on network setup.

### 8.2.1 Hardware Setup

This procedure will need to be followed after a factory reset.

#### Procedure

1. Press - (the green instrument status light button), this will take you to the home screen.
2. Press - (-99+) on the keypad. This will open the **Advanced Menu**.
3. Open - **Advanced Menu** → **Hardware Menu**.
4. Enable - **Network Port** → **Enabled**.

---

## 8.3 Rack Mount Kit (PN: E020116)

---

The rack mount kit is necessary for installing the Serinus into a 19" rack (the Serinus is 4RU in height).

**Table 8 – Included Parts (Rack Mount Kit)**

Description	Quantity	Part Number
Rack Slide Set	1	H010112
Rack Mount Adaptors	4	H010133
Rack Mount Ears	2	H010134
Spacers	4	HAR-8700
M6 x 20 Button Head Screws	8	
M6 Washers	16	
M6 Nyloc Nuts	8	
M4 x 10 Button Head Screws	18	
M4 Washers	8	
M4 Nyloc Nuts	8	
M6 Cage Nuts	8	

#### Installing the Instrument

1. Remove the rubber feet from the instrument (if attached).
2. Separate the slide rail assembly by pressing the black plastic clips in the slide rails to remove the inner section of the rail.



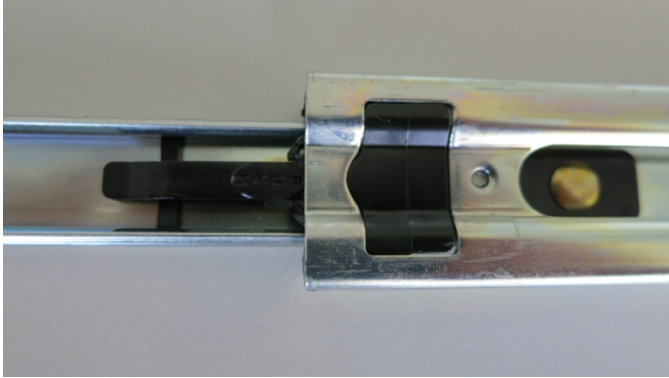

**Figure 67 – Separate Rack Slides**

3. Attach the inner slide rails to each side of the instrument using M4 x 10 button screws; three on each side (refer to Figure 68).



**Figure 68 – Assemble Inner Slide on Chassis**

4. Install rack mount ears on the front of the instrument using two M4 x 10 screws on each side (refer to Figure 69).



**Figure 69 – Rack Mount Ears Fitted to Instrument**

5. Attach the rack mount adaptors to the ends of the outer slide rails using M4 x 10 button screws, washers and locknuts. Do not fully tighten at this stage as minor adjustments will be required to suit the length of the rack (refer to Figure 70).



**Figure 70 – Attach Rack Mount Adaptors to Outer Slides**

6. Test fit the rack slide into the rack to determine the spacing of the rack mount adaptors.

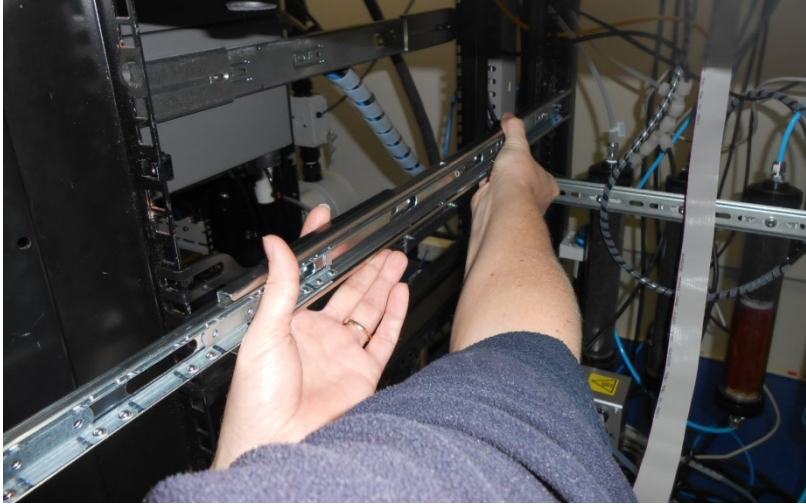

**Figure 71 – Test Fit the Rack Slide Assembly into the Rack**

7. Install the two assembled outer slide rails onto the left and right side of the rack securely with M6 bolts; washer and locknuts/cage nuts (refer to Figure 72).

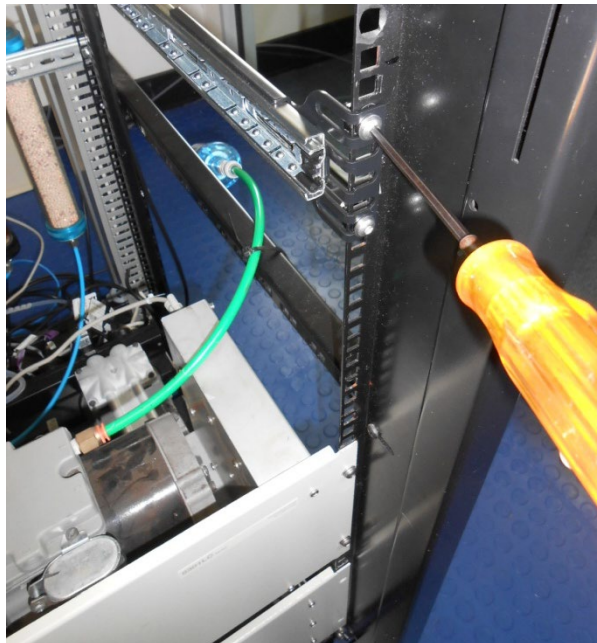

**Figure 72 – Attach Slides to Front of Rack**

8. Now carefully insert the instrument into the rack by fitting the instrument slides into the mounted rails. Ensuring that the rack slide locks engage on each side.



**CAUTION**

When installing this instrument ensure that appropriate lifting equipment and procedures are followed. It is recommended that two people lift the instrument into the rack due to the weight, unless proper lifting equipment is available.

**Note:** Ensure both sides of the inner slide are attached to the outer slides before pushing into the rack fully.

9. Push the instrument into the rack. Adjust and tighten the screws as required to achieve a smooth and secure slide.

### To Remove the Instrument

1. To remove the instrument first pull instrument forward of rack giving access to the slides.
2. Find the rack slide lock labelled **Push** and push it in whilst sliding the instrument out of the rack, complete this for both sides while carefully removing instrument.

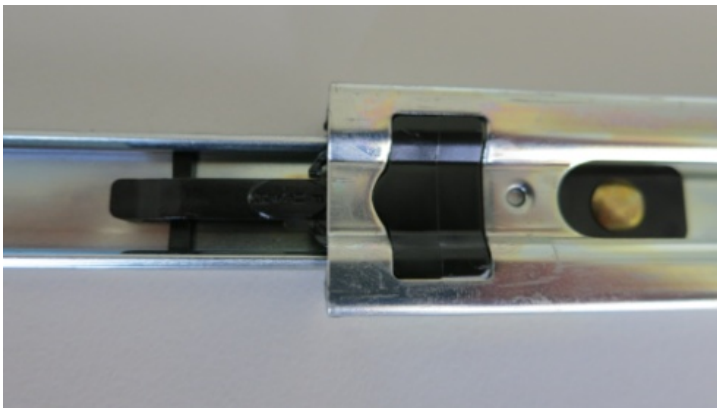

Figure 73 – Slide Clips

---

## 8.4 Internal Pump (PN: E020107)

---

### 8.4.1 Hardware Setup

This procedure should be followed after a factory reset.

#### Equipment Required

- NA

#### Procedure

1. Press - (the green instrument status light), this will take you to the home screen.
2. Press - (-99+) on the keypad. This will open the **Advanced Menu**.
3. Open - **Advanced Menu** → **Hardware Menu**.
4. Enable - **Internal Pump** → **Enabled**.

### 8.4.2 Internal Pump Additional Components

The Serinus 31 internal pump option includes the following additional components:

**Table 9 – Internal Pump Additional Components**

Component	Description	Part number
Internal pump	Draw sample through the instrument	H010027
Flow block	Includes sintered filter and differential pressure sensor to measure flow.	H010120
Heater and Thermistor	Mounted in flow block to measure and control temperature for accurate flow measurement.	Installed in flow block

### 8.4.3 Internal Pump Removed Components

The Serinus 31 has a number of components missing from the standard instrument due to the presence of the internal pump and flow block controlling flow within the instrument. The parts that have been removed when this option is installed are listed in the table below.

**Table 10 – Internal Pump Removed Components**

Component	Part number
Sintered filter	H010047-01
O-ring	O010013
Spring	H010040
O-ring	O010013
Orifice	H010043-13

### 8.4.4 Pressure Calibration Internal Pump Option

The internal pump requires a separate modified procedure to allow the internal pump to generate the necessary vacuum (refer to Section 5.3).

### 8.4.5 Flow Calibration

The flow calibration menu is only available when the internal pump option is installed (refer to Section 3.4.12).

The internal pump requires a separate flow calibration procedure. The flow calibration detailed in Section 5.9 must be performed after any pump service or pressure calibration.

### 8.4.6 Internal Pump Leak Check

The internal pump requires a separate modified procedure to leak check the system (refer to Section 6.4.3.1).

### 8.4.7 Pump Control

This section describes how to turn off and on the internal pump for servicing and maintenance purposes.

## Procedure

1. Open - **Main Menu** → **Service Menu** → **Diagnostics Menu** → **Internal Pump Menu**.
2. Select - **Pump Control** → **Manual**.
3. Toggle Off - **Internal Pump** → Off.

---

## 8.5 Metric Fittings Kit (PN: E020122)

---

The metric fittings kit allows the user to connect 6 mm tubing to the rear ports of the analyser. This can be very handy if it is hard to source ¼" tubing from a local supplier.

---

## 8.6 High Pressure Zero/Span Valves

---

**High pressure span calibration valve (factory installed (PN: E020108))**

**High pressure zero calibration valve (factory installed (PN: E020109))**

For more information on how to setup and use the high pressure valves refer to section 5.10.

Please refer to Section 9.11 for the exploded assembly drawing.

**Note:** Before using a high pressure span or zero as a source for calibrating the instrument, please check your local regulatory requirements.

## 9. Parts List and Schematics

### 9.1 Serinus Accessories Kit

This kit contains assorted fittings, tubing and an orifice removal tool which are useful when working on the instruments internal pneumatics. This is usually purchased with the instrument.

**Table 11 – Serinus Accessories Kit – (PN: H010136)**

Part Description	Quantity	Part Number
Kynar Union Tee Fitting	4	F030007-01
Kynar Union Fitting	2	F030008
Adapter, 1/4" Fitting to 1/8" Barb	4	H010007
Adapter, 1/4" Tube to 1/8" Barb	2	H010008
Orifice Extraction Tool	1	H010046
Ecotech Tubing (1/4" OD, 1/8" ID (Clear))	3 Feet	T010026
Neoprene Tubing (1/4" OD, 1/8" ID (Black))	3 Feet	T010021

### 9.2 Maintenance Kit

This maintenance kit is required when performing annual maintenance on the instrument. Depending on the environment the instrument is operating, this maintenance may need to be carried out more often than yearly.

**Table 12 – Serinus 31 Maintenance Kit – (PN: E020208)**

Part Description	Quantity	Part Number
Stainless Steel Sintered Filter with O-Ring Groove	2	H010047-01
O-Ring (0.364 ID X 0.070 W)	3	O010010
O-Ring (5/32 ID X 1/16 W (BS007))	6	O010013
Viton O-Ring (1/4 ID X 1/16 W)	2	O010015
Viton O-Ring (13/16 ID X 1/16 W)	2	O010016
Viton O-Ring (BS015)	5	O010023
O-Ring (BS110)	1	ORI-1009
Ecotech Tubing (1/4" OD, 1/8" ID (Clear))	3 Feet	T010026
O-Ring (1.989ID x 0.07W)	2	O010054
Compression Spring (0.24)	1	H010040

## 9.3 Consumables

Parts shown as consumables below will require replacement over the course of the instrument's lifespan.

**Table 13 – Serinus 31 Consumables**

Part Description	Part Number
47 mm, 5 micron, Teflon Filter Paper, Pack of 50	F010006-01
47 mm, 5 micron, Teflon Filter Paper, Pack of 100	F010006
#14 Orifice – Used In The Measurement Cell	H010043-13
#5 Orifice – Used in the Aux In Port (Purge Air)	H010043-03
Stainless Steel Sintered Filter with O-Ring Groove	H010047-01
External Pump Repair Kit (To Suite a 607 Pump)	P031001
Internal Pump Repair Kit (to suit KNF Pump)	P031005
Ecotech Tubing, 25 ft Length	T010026-01
500 g Bottle of Soda Lime used for scrubber media	ECO-1032

**\*Warranty Disclaimer:** The product is subject to a warranty on parts and labour from date of shipment (the warranty period). The warranty period commences when the product is shipped from the factory. **Lamps, fuses, batteries and consumable items are not covered by this warranty.** Subject to variable ambient conditions, toxic gases, dirt, extremes of temperature and moisture ingress may shorten the lifespan of components.

## 9.4 Instrument Parts List

List of Serinus 31 components and part numbers for reference:

**Table 14 – Spare Parts List Serinus 31**

Part Description	Part Number
Main Controller PCA	E020230-01
Serinus Power Supply, Auto-ranging	P010013
Measurement Cell Assembly	H014150
Infrared Source, Used in Source Timing Assembly	H014201-30
Narrow-Bandpass Filter, Used in the Detector Assembly	H014151
Detector PCA	C010009
Detector	S030005-30
Pressure Sensor PCA	C010004
Pressure Sensor Gasket	H010037
Source Timing Assembly	H014160
Motor Assembly	M020006-30



Part Description	Part Number
Correlation Wheel Assembly	H014116
Optical Interrupter	S030002-30
Measurement Cell Heater, Thermister Assembly	C020073
Sapphire Window	H014111
Spring Compression Used in The Measurement Cell	H010040
#14 Orifice Used in The Measurement Cell	H010043-13
#5 Orifice Used in Aux In Port for purge flow	H010043-03
Stainless Steel Sintered Filter with O-Ring Groove	H010047-01
Cover Plate Gasket For Measurement Cell	H014212
Front Panel Assembly	H010130
Serinus 31 Label For Front Panel Assembly	H010132-06
Rear Panel PCA	C010002-01
Rear Panel PCA With Network Port	C010002-10
Calibration Valve Manifold Assembly	H010013-01
Silicone Heat Sink Compound	C050013
Sample Filter Holder Assembly	H010160
Fan For Rear Panel	C020058
Fan Filter Kit for Rear Panel Fan	H010044
Barb Adaptor	H010007
Fitting Kynar Bulkhead	F030023
O-Ring, Flat and Spherical Mirrors Within the Cell – Factory Fitted Only	O010011
O-Ring, Cell Mounting End Plates	O010009
Sample Dryer Assembly	H014180
Stop Valve For Use With Internal Pump	H030170
Internal Pump Assembly Spare Part (KNF Pump)	H010027
Internal Pump Repair Kit (to suit KNF Pump)	P031005
External Pump (607 Pump) 240 VAC	P030004
External Pump (607 Pump) 110 VAC	P030005
External Pump Repair Kit (To Suite a 607 Pump)	P031001
Extraction Tool, Sintered Filter and Orifice	H010046
Insertion Tool, Sintered Filter and Orifice	T030015
Minifit Extraction Tool	T030001
Serinus 31 User Manual	M010065
USB Memory Stick	H030021
47 mm, 5 micron, Teflon Filter Paper, Pack of 50	F010006-01

Part Description	Part Number
47 mm, 5 micron, Teflon Filter Paper, Pack of 100	F010006
Soda Lime Scrubber	98415105-8
500 g Bottle of Soda Lime used for scrubber media	ECO-1032

## 9.5 Plumbing Schematic – (PN: D020023)

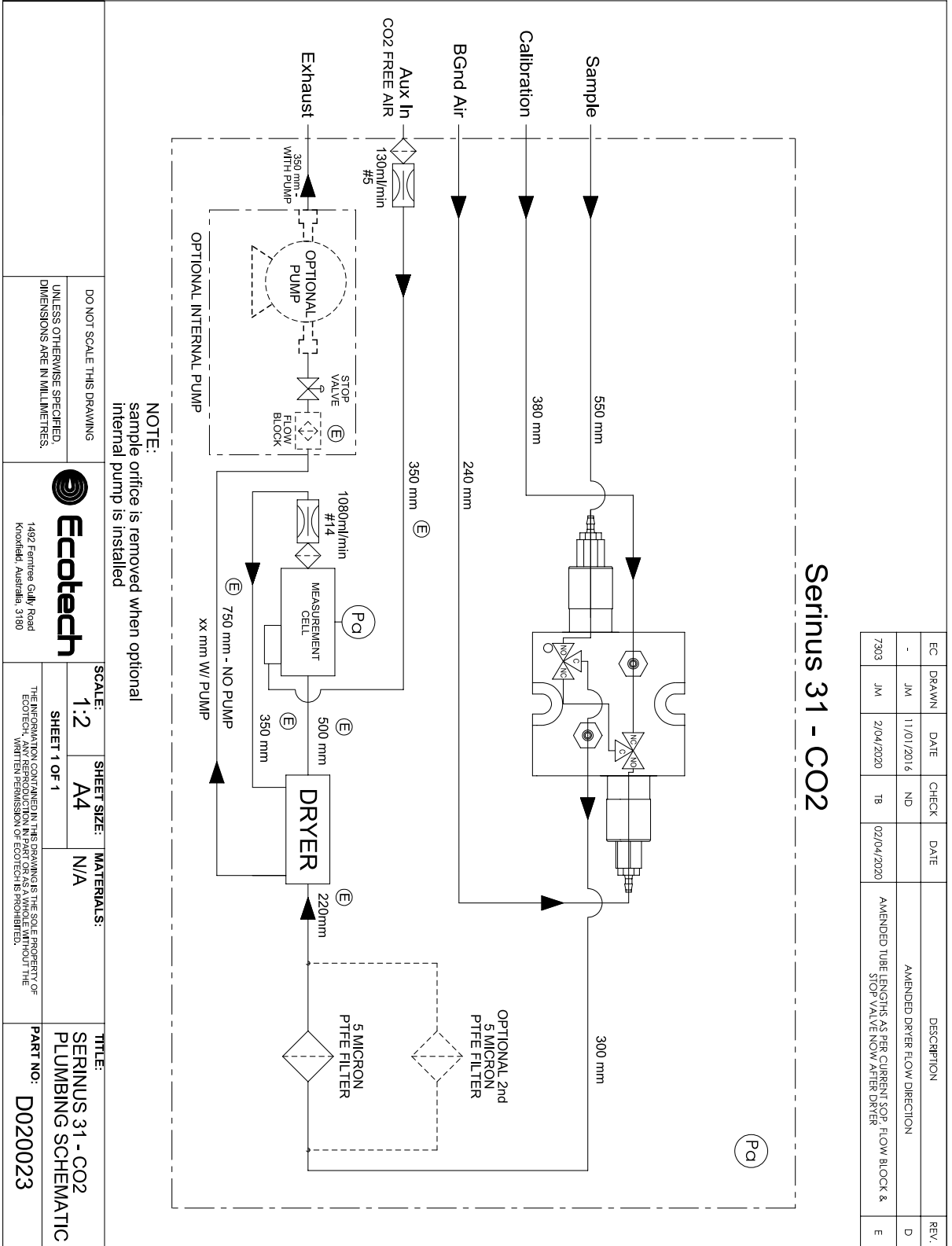

### 9.6 Block Wiring Schematic – (PN: D020110)

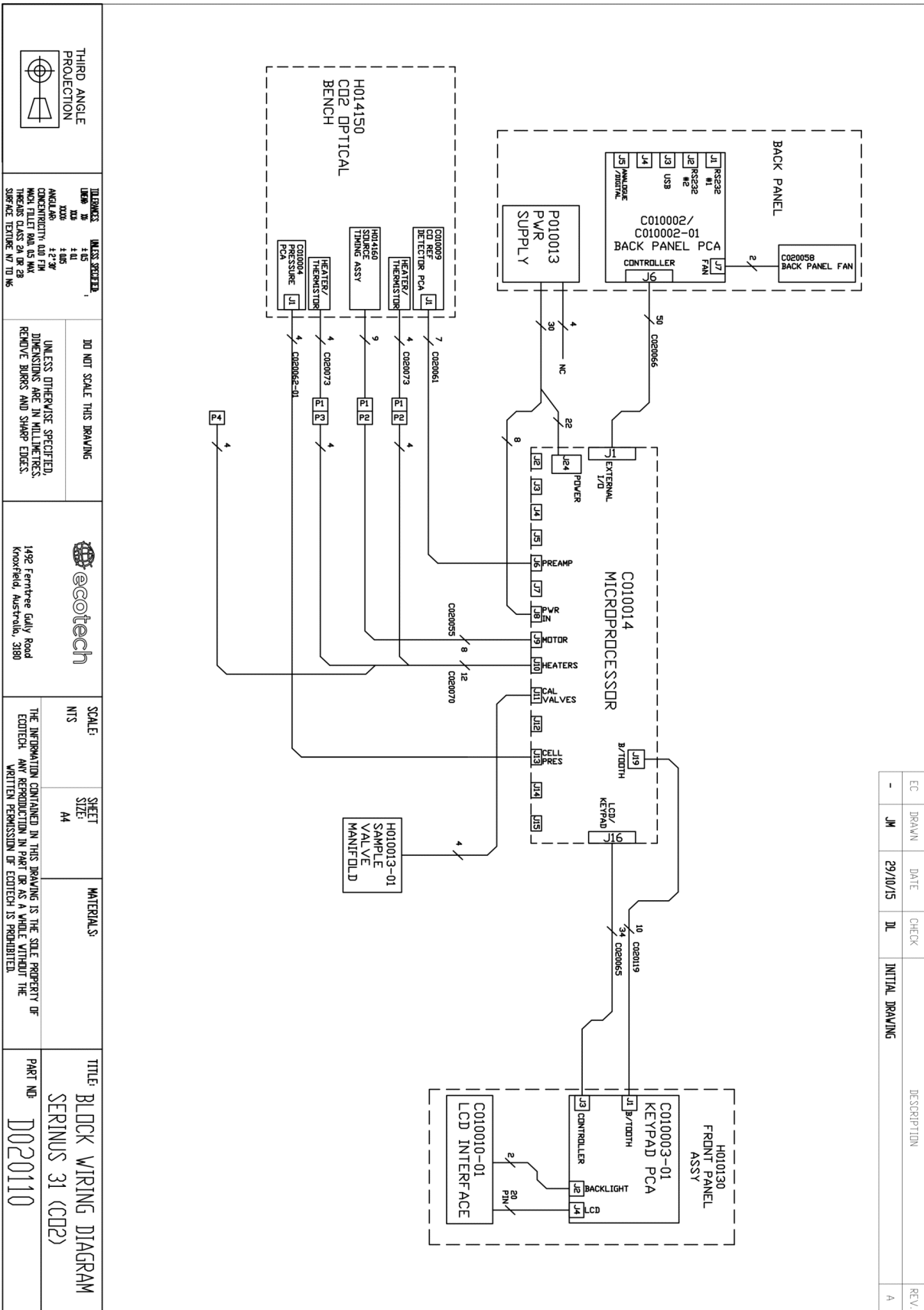

## 9.7 CO2 Cell Assembly – (PN: H014150)

ITEM NO.	PART NUMBER	DESCRIPTION	QTY.
1	H014110	CO CELL BASIC ASSY	1
2	O010023	O-RING BS038, SILICONE	1
3	F050010	M3X10 SEMS PAN HEAD PHILLIPS SCREW	9
4	F050006	HEX SPACER M3 X 10MM, 5MM STUD BRASS NICKLE PLATED, MALE/FEMALE	4
5	C010009	PCA CO DETECTOR GAS ANALYZER	1
6	F050024	M4 X 30 SEMS	4
7	F050011	M3X6 SEMS PAN HEAD PHILLIPS SCREW	4
8	H010037	GASKET PRESSURE SENSOR	1
9	H014103	COVER, CORRELATION WHEEL	1
10	H014160	MOTOR, OPTO, LAMP, ADAPTOR PLATE & CORRELATION WHEEL ASSLY	1
11	O010010	O-RING 0.364ID X 0.070W, BS012 VITON	1
12	H014106	ADAPTOR, SENSOR TO CELL, CO	1
13	H014151	FILTER INFRARED CO BAND +55C	1
14	S030005	DETECTOR LEAD SLENDIE 4.7MI	1
15	FAS-M3SS-12	M3X12 CSR SCREW, HEX DRIVE	2
16	H014126	COVER SENSOR, CO	1
17	F050012	M4 X 10 SEMS	4
18	F030023-NO CAP	FITTING KYNAR BULKHEAD UNION 1/4T	1
19	H010043-13	ORIFICE 1.4 MIL	1
20	H010007	ADAPTOR, 1/4" FITTING TO 1/8" BARB	2
21	ORH1009	ORING, BS-110 VITON	1
22	H010040	SPRING COMPRESSION, 0.24 DIA 0.630 mm WIRE	1
23	O010013	O-RING 5/32ID X 1/16W VITON	2
24	H014212	FITTING KYNAR BULKHEAD UNION 1/4T	1
25	H014211	GASKET	1
26	H014211	COVER PLATE	1
27	C010004	PCA, PRESSURE GAUGE, GAS ANALYZER	1
28	F030032-02	FITTING KYNAR MALE ELBOW 1/4T - 1/8NPT	1
29	C020073	HEATER & THERMISTOR ASSEMBLY	2
30	3mmx10	WASHER, FLAT, M3 X 10mm, ZP	1
35	PH3BY6	M3X6 PAN HEAD PHILLIPS SCREW	1
33	H014111	WINDOW, SAPHIRE, CO, SERRINUS	1
34	H010047-01	FILTER, SINTERED W/O-RING GROOVE	1
35	H014215-05	HEATSIK, DETECTOR, CO, SERRINUS	1

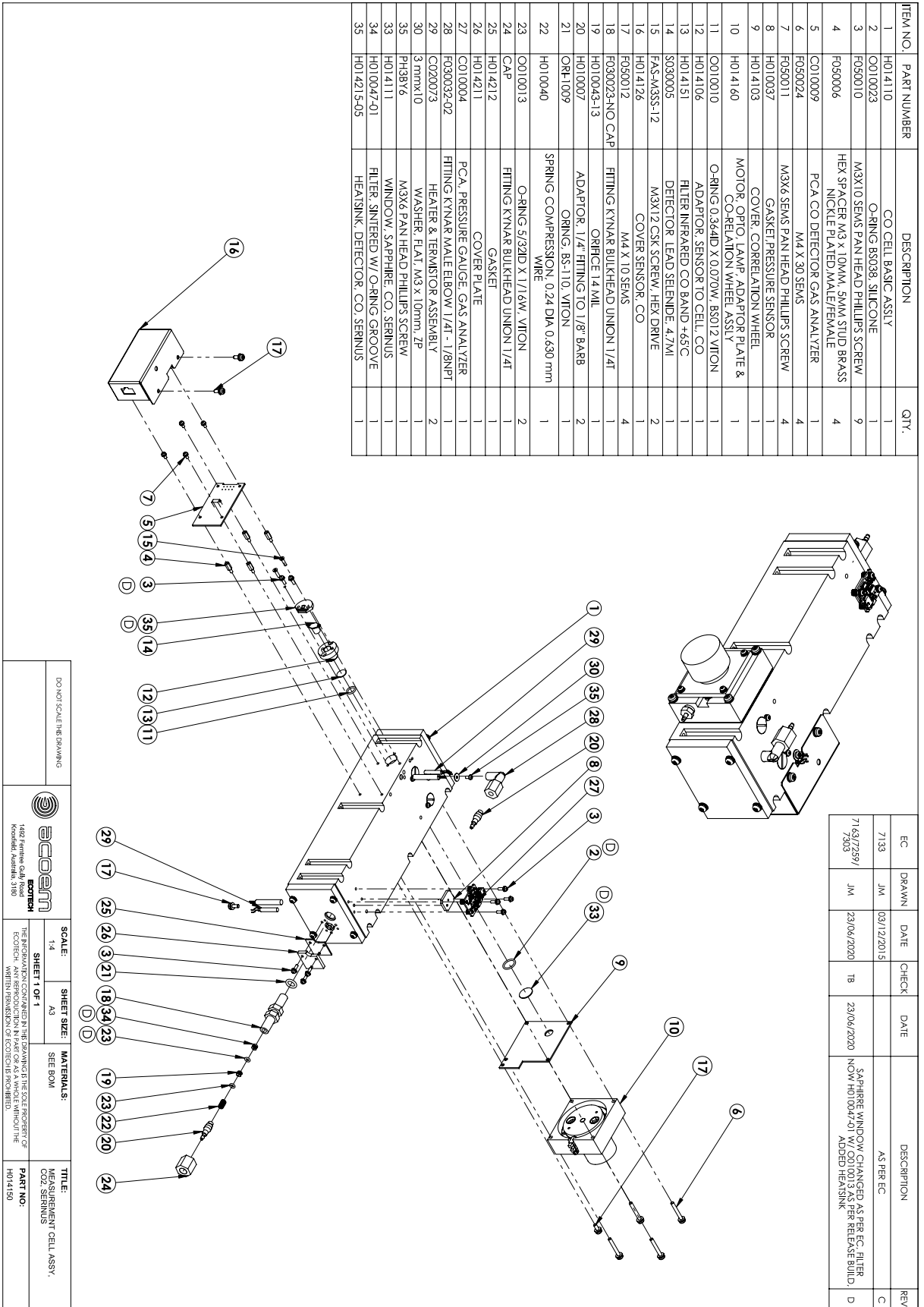

## 9.8 Source Timing Assembly – (PN: H014160)

REV.	DESCRIPTION	DATE	CHECK	DATE	EC	DRAWN	DATE
A	INITIAL ISSUE		JM		-	ND	18/09/2015
B	F030006-01 WAS F030006, CHANGE AS PER EC		ND		7154	JM	9/05/2016
C	MOTOR CHANGED, H014104 REMOVED AS PER EC		ND		7145	JM	27/06/2016
D	LOGO AND TITLE BLOCK UPDATED		TS	23/06/2020	7145	JM	23/06/2020

ITEM NO.	PART NUMBER	DESCRIPTION	QTY.
1	H014102	ADAPTOR PLATE, MOTOR AND CORRELATION WHEEL	1
2	H014201	SOURCE ASSY CLEANED / BURNED-IN	1
3	S030002	OPTO. SENSOR, SLOTTED SERINUS	1
4	H014116	CORRELATION WHEEL, CO2	1
5	FAS-M3BS-2	M3 x 5 GRUB SCREW KNURLED CUP POINT	2
6	F050010	M3X10 SEMS PAN HEAD PHILLIPS SCREW	6
7	F050011	M3X6 SEMS PAN HEAD PHILLIPS SCREW	1
8	F030006-01	FITTING, MALE CONNECTOR 1/8NPT - 1/8 BARB, KYNAR	1
9	M020006-01	MOTOR ASSEMBLY, CORRELATION, SERINUS	1

SCALE: 1:2  
SHEET SIZE: A4  
MATERIALS: SEE BOM  
TITLE: SOURCE TIMING ASSY, CO2

DO NOT SCALE THIS DRAWING

**ECOEM**  
ECOTECH  
1492 Fernber Gully Road  
Knoxfield Australia, 3150

THE INFORMATION CONTAINED IN THIS DRAWING IS THE SOLE PROPERTY OF ECOTECH. ANY REPRODUCTION IN PART OR AS A WHOLE WITHOUT THE WRITTEN PERMISSION OF ECOTECH IS PROHIBITED.

PART NO: H014160

## 9.9 Calibration Manifold Assembly – (PN: H010013-01)

**NOTES:**

- VALVES MUST BE FREE OF DIRT, GREASE OR ANY OTHER FOREIGN MATERIAL.
- F030006-01 THREADS MUST BE SEALED WITH SWAGelok THREAD TAPE.
- MANIFOLD BLOCK MUST BE FREE OF DIRT GREASE OR ANY OTHER FOREIGN MATERIAL. ASSEMBLY MUST PASS LEAK TEST UNDER VACUUM OF -90 KPA. MAX DROP ALLOWED IS 2 KPA IN 5 MINS.
-

EC	DRAWN	DATE	CHECK	DESCRIPTION	REV.
	VC	16/03/10		INITIAL DRAWING	X1
	BP	22/08/2014	JM	BOM ADDED	B
	ND	9/11/2015	JM	COMPANY LOGO UPDATED IN TITLE BLOCK	C
7154	JM	3/05/2016	ND	FITTING CHANGED AS PER EC	D

ITEM NO.	PART NUMBER	DESCRIPTION	QTY.
1	H010014-01	VALVE MANIFOLD	1
2	H010042	VALVE MFLD, 3 WAY, 12VDC	2
3	F030006-01	FITTING, MALE CONNECTOR 1/8NPT - 1/8 BARB, KYNAR	4

**TOLERANCES UNLESS SPECIFIED:**

LINEAR: XX: ±0.5  
X: ±0.25  
X.X: ±0.1

ANGULAR: ±2°30'

CONCENTRICITY: 0.10 MM  
MACH. HOLE RAO: 0.3 MAX  
THREAD CLASS: 2A OR 2B  
SURFACE FINISH: 10 N6

DO NOT SCALE THIS DRAWING

UNLESS OTHERWISE SPECIFIED, DIMENSIONS ARE IN MILLIMETERS. REMOVE BURRS AND SHARP EDGES.

**SCALE:** NTS

**SHEET SIZE:** A4

**SHEET 1 OF 1**

**MATERIALS:** AS NOTED

**TITLE:** CALIBRATION VALVE MANIFOLD

**PART NO:** H010013-01

THE INFORMATION CONTAINED IN THIS DRAWING IS THE SOLE PROPERTY OF ECOTECH. ANY REPRODUCTION IN PART OR AS A WHOLE WITHOUT THE WRITTEN PERMISSION OF ECOTECH IS PROHIBITED.

**ecotech**

1492 Fernree Gully Road  
Knoxfield, Australia, 3180

**THIRD ANGLE PROJECTION**

## 9.10 Valve Assembly – (PN: H010042)

ITEM NO.	PART NUMBER	QTY.
1	BODY	1
2	SOLENOID COIL	1
3	NUT	1
4	PLUNGER	1
5	O010016	1
6	O010015	1
7	O010010	1
8	O010023	1
9	Stem	1

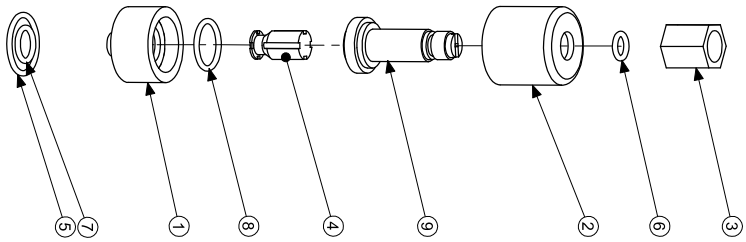

### STEPS TO REPLACE O-RINGS

1. MARK THE SOLENOID COIL WITH A PERMANENT MARKER TO IDENTIFY THEIR RESPECTIVE VALVES AND THEIR POSITION ON MANIFOLD BLOCK
2. SECURE THE 3-WAY VALVE UPRIGHT INTO A LARGE VICE WITH PROTECTION AROUND ITS BODY TO PREVENT SCRATCH OR DAMAGE TO VALVE
3. REMOVE NUT FROM THE TOP OF THE 3-WAY VALVE USING A 9/16" SPANNER
4. REMOVE SMALL O-RING FROM AROUND 3 WAY VALVE USING 2 MM FLAT SCREW DRIVER
5. LIFT OFF THE SOLENOID COIL FROM THE 3-WAY VALVE THEN UNCREW THE SHAFT FROM THE BASE USING A LARGE FLAT SCREW DRIVER
6. WHILE UNSCREWING TAKE CARE THAT THE INTERNAL PLUNGER DOES NOT FALL OUT
7. REPLACE THE INTERNAL O-RING WITH O010023
8. ASSEMBLE THE SHAFT ALONG WITH PLUNGER BACK IN ITS POSITION
9. ASSEMBLE NEW O010015 O-RING SUPPLIED
10. ASSEMBLE THE NUT ON TOP OF 3-WAY VALVE
11. ASSEMBLE O010016 AND O010010 O-RINGS ON THE BOTTOM OF THE VALVE
12. ASSEMBLE VALVE BACK IN MANIFOLD BLOCK





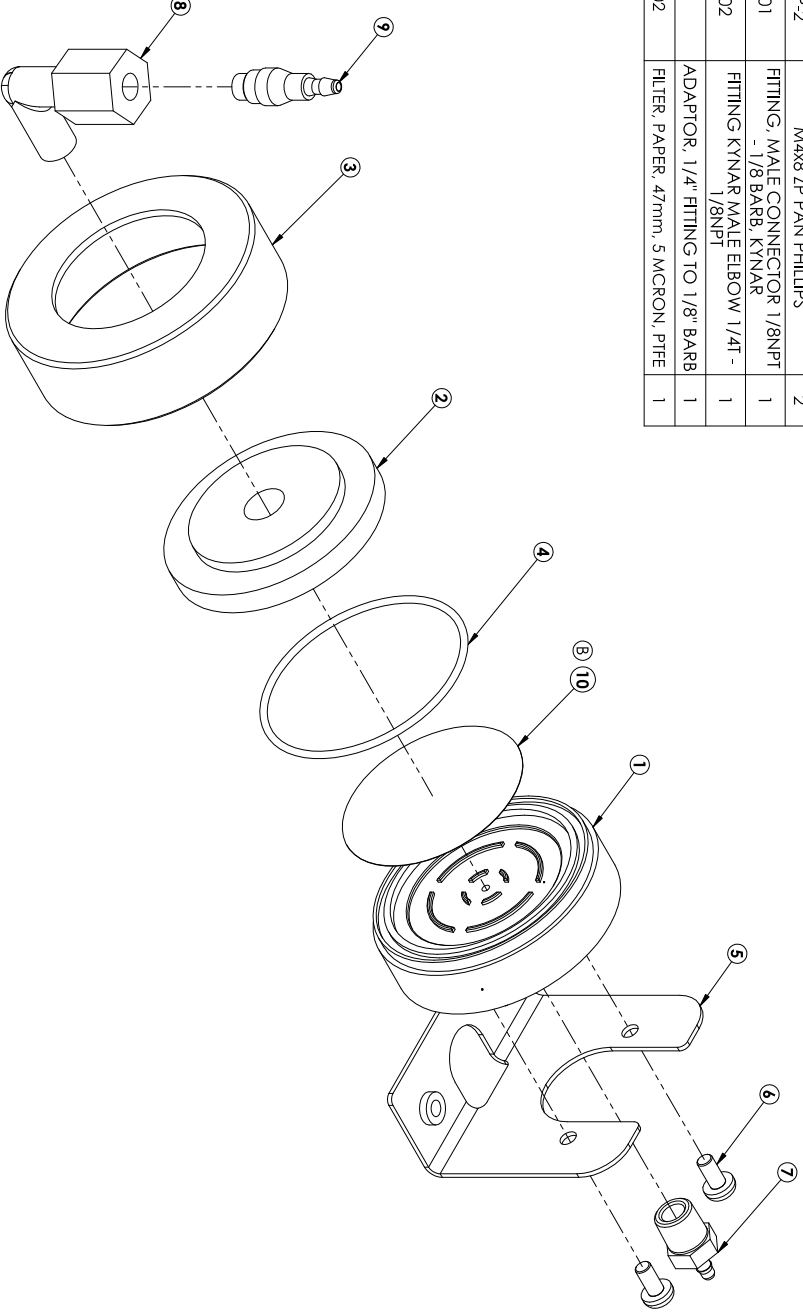

## 9.12 Sample Filter – (PN: H010160)

ITEM NO.	PART NUMBER	DESCRIPTION	QTY.
1	H010161	BASE, SAMPLE FILTER, 47MM, SERINUS	1
2	H010152	CAP, SEALING, SAMPLE FILTER, SERINUS	1
3	H010153	SAMPLE FILTER 47MM RETAINING RING	1
4	O010054	O-RING, BS224, VITON	1
5	H010021	SAMPLE FILTER BRACKET	1
6	FAS-M4ZP-2	M4X8 ZP PAN PHILLIPS	2
7	F030006-01	FITTING, MALE CONNECTOR 1/8NPT - 1/8 BARB, KYNAR	1
8	F030032-02	FITTING KYNAR MALE ELBOW 1/4" - 1/8NPT	1
9	H010007	ADAPTOR, 1/4" FITTING TO 1/8" BARB	1
10	F010006-02	FILTER, PAPER, 47mm, 5 MICRON, PTFE	1

EC	DRAWN	DATE	CHECK	DESCRIPTION	REV.
T/51	JM	09/04/2018	VC	INITIAL DRAWING	A
T/51	JM	17/01/2019	VC	ADDED MISSING FILTER F010006-02	B

 THIRD ANGLE PROJECTION		DIMENSIONS UNLESS SPECIFIED: INCHES: XX, .XX, .015 MILLIMETERS: XX, .XX, .015 ANGLES: XX° XX' XX" UNLESS OTHERWISE SPECIFIED, DIMENSIONS ARE IN MILLIMETERS. REMOVE BUBBLES AND SHARP EDGES.		DO NOT SCALE THE DRAWING		 1992 Fernvale Gully Road Knoxville, Australia, 380		SCALE: 1:1 SHEET 1 OF 1 SHEET SIZE: A3	MATERIALS:	TITLE: SAMPLE FILTER ASSY, FACE SEAL, SERINUS PART NO.: H010160
--	--	--	--	--------------------------	--	--	--	--	------------	---

## Appendix A. Advanced Protocol

The Advanced protocol allows access to the full list of instrument parameters.

### A.1 Command Format

All Serial, USB, and Network requests sent to the Instrument and received in response from the instrument will be in the following packet format to ensure data is reliable.

**Table 15 – Packet Format**

1	2	3	4	5	6 ... 5+n	6+n	7+n
STX (2)	Serial ID	Command	ETX (3)	Message Length (n)	Message	Checksum	EOT (4)

Where:

<STX> ASCII Start of Text = 0x02 hex.

Serial ID The Serial ID assigned in the **Main Menu** → **Communications Menu** → **Serial Communication Menu**.

<ETX> ASCII End of Text = 0x03 hex.

Checksum The XOR of the individual bytes except for STX, ETX, EOT and Checksum.

Message length Must be in the range 0 to 32. Responses from the instrument can have a message Length of 0 to 255.

<EOT> ASCII End of Transmission = 0x04 hex.

### Examples

A basic request for Primary gas data would be as follows:

**Table 16 – Example: Primary Gas Request**

Byte Number	1	2	3	4	5	6	7	8
Description	STX	ID	Command	ETX	Message Length	Primary Gas Conc	Checksum	EOT
Value	2	0	1	3	1	50	50	4
Checksum Calculation		0	$0 \oplus 1 = 1$		$1 \oplus 1 = 0$	$0 \oplus 50 = 50$	50	

And a sample response:

**Table 17 – Example: Primary Gas Response**

Byte Number	1	2	3	4	5	6	Continued in next table.
Description	STX	ID	Command	ETX	Message Length	Primary Gas Conc	
Value	2	0	1	3	5	50	
Checksum Calculation		0	$0 \oplus 1 = 1$		$1 \oplus 5 = 4$	$4 \oplus 50 = 54$	

**Table 18 – Example: Primary Gas Response (continued)**

Byte Number	7	8	9	10	11	12
Description	IEEE representation of 1.00				Checksum	EOT
Value	63	128	0	0	50	4
Checksum Calculation	$54 \oplus 63 = 9$	$9 \oplus 128 = 137$	$137 \oplus 0 = 137$	$137 \oplus 0 = 137$	137	

## A.2 Commands

### Communication Error

Where:

- Command byte        0
- Message byte 1     0
- Message byte 2     0..7

If the command byte of a response is 0, this indicates an error has occurred. The message field will be 2 bytes long, where the 2<sup>nd</sup> byte indicates the error according to the following table.

**Table 19 – List of Errors**

Error #	Description
0	Bad Checksum received
1	Invalid Parameter Length
2	Invalid Parameter
3	Internal Data Flash Erase in Progress unable to return data for a few seconds
4	Unsupported Command.
5	Another process is collecting data – unable to service request.
6	MemStick No Connected
7	MemStick Busy

## Get IEEE Value

Where:

- Command byte        1
- Message byte 1      Index from List of Parameters
- Message byte 2..32 Additional indexes (optional)

This command requests the value of an instrument parameter. The message field byte contains the index of the parameter requested, as described in the List of Parameters.

Up to 32 indexes can be supplied in a single request. The response has 5 bytes for each parameter requested – the first byte is the parameter index and the next four are the IEEE representation of the current value.

### Example

A request with a message field of 50,51,52 to a Serinus S40 would return a 15 byte message as shown below:

**Table 20 – Example: Get IEEE Response data**

1	2	3	4	5	6	7	8	9	10	11	12	13	14	15
50	NO reading				51	NOx reading				52	NO2 reading			

## Set Calibration Mode

Where:

- Command byte        4
- Message byte 1      85
- Message byte 2-5    The IEEE representation of 0, 1, 2, or 3
  - 0 puts the instrument into Measure mode (0,0,0,0)
  - 1 puts the instrument into Cycle mode (63,128,0,0)
  - 2 puts the instrument into Zero mode (64,0,0,0)
  - 3 puts the instrument into Span mode (64,64,0,0)

This command puts the instrument into a calibration mode (the same as going to the Calibration menu and choosing a Cal. Mode).

### Example

A request with a command of 4 and a message field of 85,64,64,0,0 would place the instrument into Span mode.

### Set Calibration

Enters a new calibration value: the same as entering Span Calibrate or Zero Calibrate on the calibration menu.

Where:

- Command byte            18
- Message byte 1        0, 1, 2, or 3 where
  - 0 = Span
  - 1 = Zero (first zero gas)
  - 2 = Zero (second zero gas)
  - 3 = Zero (Third zero gas)
- Message byte 2-5      The IEEE representation of the calibration value.

## A.3 List of Parameters

**Note:** Parameters are for all Serinus series analysers and may not be applicable to an individual instrument.

**Table 21 – Advanced Protocol Parameter List**

#	Description	Notes
1	Cal/Zero Valve	0 = Zero, 1 = Cal
2	Internal Span Valve	0 = Off, 1 = On
3	Positive Supply	Positive analog supply voltage
4	Gas 5 Avg.	Average of the readings (for Gas5) of the last n minutes where n is the averaging period E.g. Nx
5	Pregain	S30H linearization coefficient gain
6	Sample/Cal Valve	0 = Sample, 1 = Cal/Zero
7	NOx Measure Valve	0 = NO, 1 = NOx
8	NOx Bypass Valve	0 = NO, 1 = NOx
9	NOx Backgnd Valve	0 = Off, 1 = On
10	Valve Sequencing	0 = Off, 1 = On
11	LCD Contrast Pot	0 = Lightest, 255 = Darkest
12	SO2 Ref Zero Pot	S50 Reference zero pot
13	CO Input Pot	S30 Input pot
14	CO Reference Test Pot	Not Used
15	CO Measure Pot	Not Used
16	High Volt Adjust Pot	PMT High Voltage Adjust Pot for S50 & S40

17	SO2 Lamp Adjust Pot	S50 Lamp adjustment Pot
18	O3 Lamp Adjust Pot	S10 Lamp adjustment Pot
19	O3 Meas. Zero Pot (C)	S10 Signal zero measure (coarse)
20	O3 Meas. Zero Pot (F)	S10 Signal zero measure (fine)
21	PMT Fan Pot	Optical Bench fan speed control pot
22	Rear Fan Pot	Chassis Fan speed control pot
23	Pump Fine Pot	Internal Pump speed fine pot
24	Pump Coarse Pot	Internal Pump speed coarse pot
25	Analog input 0	SO2 Reference signal
26	Analog input 1	CO Reference signal
27	Analog input 2	O3 Reference signal
28	Analog input 3	SO2 & O3 Lamp current
29	Analog input 4	Flow block pressure
30	Analog input 5	Cell pressure
31	Analog input 6	Ambient pressure
32	Analog input 7	Raw ADC calibration input
33	Analog input 8	Reserved
34	Analog input 9	Concentration data
35	Analog input 10	Reserved
36	Analog input 11	Reserved
37	Analog input 12	Raw analog to digital count for external analog input 0. 0-5V= 0-32766 A/D counts
38	Analog input 13	Raw analog to digital count for external analog input 1. 0-5V= 0-32766 A/D counts
39	Analog input 14	Raw analog to digital count for external analog input 2. 0-5V= 0-32766 A/D counts
40	Analog input 15	Reserved
41	CO Meas. Zero Pot (coarse)	S30 Measure ZERO coarse adjustment Pot
42	CO Meas. Zero Pot (fine)	S30 Measure ZERO fine adjustment Pot
43	SO2 Input Pot	SO2 Measure Signal Gain Pot
44	SO2 Ref. Gain Pot	SO2 Reference Signal Gain Pot
45	SO2 Meas. Zero Pot	SO2 Measure zero pot
46	O3 Input Pot	O3 Input signal gain pot
47	Diagnostic Test Pot	The Diagnostic mode adjustment pot for all the analysers except for S30
48	NOx Input Pot	PMT signal input gain control FOR NOx
49	PGA Gain	1, 2, 4, 8, 16, 32, 64, 128

50	Gas 1 Inst.	Primary gas concentration currently displayed on the front screen E.g. NO
51	Gas 2 Inst.	Secondary gas concentration currently displayed on front screen E.g. NOx
52	Gas 3 Inst.	Calculated gas concentration currently displayed on front screen E.g. NO2
53	Gas 1 Avg.	Average of the readings (for Gas1) of the last n minutes where n is the averaging period
54	Gas 2 Avg.	Average of the readings (for Gas2) of the last n minutes where n is the averaging period
55	Gas 3 Avg.	Average of the readings (for Gas3) of the last n minutes where n is the averaging period
56	Instrument Gain	Current calibration value (default is 1.0)
57	Serial ID	Multidrop or Bayern-Hessen gas id
58	Bayern-Hessen ID	For multigas instruments only
59	Decimal Places	2-5
60	Noise	Instrument noise
61	Gas 1 Offset	An offset applied to Gas 1
62	Gas 3 Offset	An offset applied to Gas 3
63	Flow Temperature	Temperature of the flow block
64	Lamp Current	Lamp current in mA E.g 35mA
65	Digital Supply	Digital Supply voltage (should always read close to 5 volts)
66	Conc. Voltage	Concentration Voltage
67	High Voltage	High Voltage reading for PMT
68	Ozonator	0 = Off, 1 = On
69	Control Loop	0 = Off, 1 = On (default is On)
70	Diagnostic Mode	0 = Operate 1 = Preamp 2 = Electrical 3 = Optical (default is Operate)
71	Gas Flow	Units in slpm
72	Gas Pressure	Units in torr
73	Ambient Pressure	Units in torr
74	12V Supply	The 12 volt Power supply voltage
75	Cell Temperature	Cell Temperature
76	Conv. Temperature	Converter Temperature
77	Chassis Temperature	Chassis Temperature



78	Manifold Temp.	Manifold Temperature																																		
79	Cooler Temperature	Cooler Temperature																																		
80	Mirror Temperature	Mirror Temperature																																		
81	Lamp Temperature	Lamp Temperature																																		
82	IZS Lamp Temperature	O3 Lamp Temperature																																		
83	Instrument Status	<p>Each bit in this 4-byte word represents a different condition (not all conditions apply to every instrument model):</p> <table border="1"> <thead> <tr> <th>BIT</th> <th>Condition if set</th> </tr> </thead> <tbody> <tr> <td>0</td> <td>Currently in warmup process</td> </tr> <tr> <td>1</td> <td>Volumetric units (ppm); otherwise gravimetric units (mg/m3)</td> </tr> <tr> <td>2</td> <td>Performing a background</td> </tr> <tr> <td>3</td> <td>Currently in Span mode</td> </tr> <tr> <td>4</td> <td>Currently in Zero mode</td> </tr> <tr> <td>5</td> <td>Instrument Out of Service (or in Diagnostic mode, PTF compensation or control loop disabled, or Comms debugging enabled)</td> </tr> <tr> <td>6</td> <td>High Voltage failure</td> </tr> <tr> <td>7</td> <td>System power failure (not actually possible to report)</td> </tr> <tr> <td>8</td> <td>Reference voltage failure</td> </tr> <tr> <td>9</td> <td>Cell temperature failure</td> </tr> <tr> <td>10</td> <td>Cooler failure</td> </tr> <tr> <td>11</td> <td>Converter failure</td> </tr> <tr> <td>12</td> <td>Correlation wheel failure</td> </tr> <tr> <td>13</td> <td>Lamp source failure</td> </tr> <tr> <td>14</td> <td>Flow fault</td> </tr> <tr> <td>15</td> <td>Any system error (the red instrument panel light is on)</td> </tr> </tbody> </table>	BIT	Condition if set	0	Currently in warmup process	1	Volumetric units (ppm); otherwise gravimetric units (mg/m3)	2	Performing a background	3	Currently in Span mode	4	Currently in Zero mode	5	Instrument Out of Service (or in Diagnostic mode, PTF compensation or control loop disabled, or Comms debugging enabled)	6	High Voltage failure	7	System power failure (not actually possible to report)	8	Reference voltage failure	9	Cell temperature failure	10	Cooler failure	11	Converter failure	12	Correlation wheel failure	13	Lamp source failure	14	Flow fault	15	Any system error (the red instrument panel light is on)
BIT	Condition if set																																			
0	Currently in warmup process																																			
1	Volumetric units (ppm); otherwise gravimetric units (mg/m3)																																			
2	Performing a background																																			
3	Currently in Span mode																																			
4	Currently in Zero mode																																			
5	Instrument Out of Service (or in Diagnostic mode, PTF compensation or control loop disabled, or Comms debugging enabled)																																			
6	High Voltage failure																																			
7	System power failure (not actually possible to report)																																			
8	Reference voltage failure																																			
9	Cell temperature failure																																			
10	Cooler failure																																			
11	Converter failure																																			
12	Correlation wheel failure																																			
13	Lamp source failure																																			
14	Flow fault																																			
15	Any system error (the red instrument panel light is on)																																			
84	Reference Voltage	Units in Volts																																		
85	Calibration State	<p>This variable has two different sets of values:</p> <table border="1"> <thead> <tr> <th>Set Calibration State</th> <th>Get IEEE Value</th> </tr> </thead> <tbody> <tr> <td>0 = MEASURE</td> <td>0 = MEASURE</td> </tr> <tr> <td>1 = CYCLE</td> <td>1 = ZERO</td> </tr> <tr> <td>2 = ZERO</td> <td>2 = SPAN</td> </tr> <tr> <td>3 = SPAN</td> <td></td> </tr> </tbody> </table>	Set Calibration State	Get IEEE Value	0 = MEASURE	0 = MEASURE	1 = CYCLE	1 = ZERO	2 = ZERO	2 = SPAN	3 = SPAN																									
Set Calibration State	Get IEEE Value																																			
0 = MEASURE	0 = MEASURE																																			
1 = CYCLE	1 = ZERO																																			
2 = ZERO	2 = SPAN																																			
3 = SPAN																																				
86	Primary Raw Conc.	(For S40, before NOx background and gain)																																		

87	Secondary Raw Conc.	Only for multigas instruments (For S40, before NOx background and gain)
88	S40 Backgnd Conc.	NOx Background Concentration (For S40, before gain)
89	Cal. Pressure	Calibration Pressure
90	Conv. Efficiency	Converter Efficiency
91	Multidrop Baud Rate	0 = 1200 bps 1 = 2400 bps 2 = 4800 bps 3 = 9600 bps 4 = 14400 bps 5 = 19200 bps 6 = 38400 bps
92	Analog Range AO 1	Maximum range value for analog output
93	Analog Range AO 2	
94	Analog Range AO 3	
95	Output Type AO 1	Output Type 1 = Voltage 0 = Current
96	Output Type AO 2	
97	Output Type AO 3	
98	Anlg Ofst/Rng AO1	Voltage Offset /Current Range 0 = 0% or 0-20mA 1 = 5% or 2-20mA 2 = 10% or 4-20mA
99	Anlg Ofst/Rng AO2	
100	Anlg Ofst/Rng AO3	
101	F/Scale Volt AO 1	5.0 Volt Calibration value
102	F/Scale Volt AO 2	
103	F/Scale Volt AO 3	
104	Z Adj Volt AO 1	0.5 Volt Calibration value
105	Z Adj Volt AO 2	
106	Z Adj Volt AO 3	
107	Negative Supply	Negative analog supply
108	Digital Outputs	A single byte expressing the most recent state of the digital outputs
109	Digital Inputs	A single byte expressing the most recent state of the digital inputs

110	Instrument State	0 = SAMPLE FILL 1 = SAMPLE MEASURE 2 = SAMPLE FILL AUX 3 = SAMPLE MEASURE AUX 4 = SAMPLE FILL AUX2 5 = SAMPLE MEASURE AUX2 6 = BACKGROUND FILL 7 = BACKGROUND MEASURE 8 = BACKGROUND PURGE 9 = BACKGROUND FILL AUX 10 = BACKGROUND MEASURE AUX 11 = ZERO FILL 12 = ZERO MEASURE 13 = ZERO FILL AUX 14 = ZERO MEASURE AUX 15 = ZERO FILL AUX2 16 = MEASURE AUX2 17 = BACKGROUND FILL ZERO 18 = BACKGROUND MEASURE ZERO 19 = SPAN FILL 20 = SPAN MEASURE 21 = SPAN FILL AUX 22 = SPAN MEASURE AUX 23 = SPAN FILL AUX2 24 = SPAN MEASURE AUX2 25 = BACKGROUND FILL SPAN 26 = BACKGROUND MEASURE SPAN 27 = BACKGROUND PURGE SPAN 28 = ELECTRONIC ZERO ADJUST 29 = INSTRUMENT WARM UP 30 = BACKGROUND ADJUST FILL 31 = BACKGROUND ADJUST MEASURE
111	CO Lin. Factor A	CO Linearisation Factor A
112	CO Lin. Factor B	CO Linearisation Factor B
113	CO Lin. Factor C	CO Linearisation Factor C
114	CO Lin. Factor D	CO Linearisation Factor D
115	CO Lin. Factor E	CO Linearisation Factor E

116	Instrument Units	0 = ppm 1 = ppb 2 = ppt 3 = mg/m <sup>3</sup> 4 = µg/m <sup>3</sup> 5 = ng/m <sup>3</sup> 6 = %
117	Backgnd Meas. Time	In seconds.
118	Sample Fill Time	These parameters can be changed, but only temporarily; restarting the instrument will restore them to their default values.
119	Sample Measure Time	
120	Aux Measure Time	
121	Aux Smpl. Fill Time	
122	Backgnd Fill Time	
123	Zero Fill Time	
124	Zero Measure Time	
125	Span Fill Time	
126	Span Measure Time	
127	O3 Gen Coeff D	O3 Generator Coefficient D
128	Backgnd Pause Time	In seconds
129	Bkgnd Intrleav Fact	
130	Cal. Pressure 2	Calibration Pressure for 2 <sup>nd</sup> gas
131	2nd Instrument Gain	Only valid with an S40 variant set to multiple gains. Shows the second gas gain (NO). Default is 1.0.
132	Background voltage	Units in Volts
133	Perm Rate	Permeation rate of the gas in ng/min
134	Perm Flow	Total flow past the permeation chamber during an activated internal span mode. In ml/min
135	Perm Oven Setpoint	Set target temperature for the permeation oven. Default is 50°C
136	Perm Oven Temp	Temperature readout of the Permeation oven. Units in °C
137	Ozone Target	Ozone Target for S10 IZS ozone generation
138	Conc Adjusted 1	Concentration value in PPM before filtering
139	Conc Adjusted 2	
140	Conc Adjusted 3	
141	Correlation Wheel Count	Revolutions in the last second
142	Correlation Wheel Frequency	In rpm
143	IR Source	The S30 IR source voltage

144	Background (hrs)	The background interval in hours. 0.0 if disabled 0.25 for every 15 minutes 0.30 for every 20 minutes 0.50 for every 30 minutes 1.00 for every hour ... 24.00 for once a day
145	Cycle Time	In minutes
146	CO Cooler Pot	CO Cooler voltage adjustment POT
147	CO Source Pot	CO Source voltage adjustment POT
148	CO Test Meas. Pot	Diagnostics use only
149	CO Test Ref. Pot	Diagnostics use only
150	O3 Ref Average	S10 Background Average
151	PTF Correction (gas 1)	Pressure Temperature Flow Compensation Factor for first gas
152	PTF Correction (gas 2)	Pressure Temperature Flow Compensation Factor for second gas in dual gas analysers.
153	Inst. Cell Pressure	Instantaneous cell pressure
154	Manifold Pressue	Manifold Pressure in S40 instruments
155	Cell Press. (gas1)	Cell Pressure for Gas 1
156	Cell Press. (gas2)	Cell Pressure for Gas 2
157	Cell Press. (Bgnd)	Cell Pressure when in Background
158	Background	0 = the instrument is measuring a gas sample 1 = the instrument is measuring background air
159	Gas To Measure	S51 only; see Measurement Settings Menu 0 = Measure both gasses 1 = Measure SO2 only 2 = Measure H2S only
160	Valve States	Diagnostic use only
161	Temperature Units	0 = "°C" 1 = "°F" 2 = "K"
162	Pressure Units	0 = "torr" 1 = "psi" 2 = "mbar" 3 = "atm" 4 = "kPa"

163	Averaging Period	<p>0 = "1 Min"            1 = "3 Mins"            2 = "5 Mins"            3 = "10 Mins"            4 = "15 Mins"            5 = "30 Mins"            6 = "1 Hr"            7 = "4 Hrs"            8 = "8 Hrs"            9 = "12 Hrs"            10 = "24 Hrs"            Added as of V 3.57.001            11 = "4 hrs/hr"            12 = "8 hrs/hr"            Added as of Build 10800 (V3.87.0 or later)            13 = "2 Mins"            14 = "4 Mins"            15 = "6 Mins"            16 = "12 Mins"            17 = "20 Mins"            18 = "2 Hrs"            19 = "6 Hrs"</p>
164	Filter Type	<p>0 = NO FILTER            1 = KALMAN FILTER            2 = 10 SEC FILTER            3 = 30 SEC FILTER            4 = 60 SEC FILTER            5 = 90 SEC FILTER            6 = 300 SEC FILTER            7 = ADPTIVE FILTER</p>
165	NO2 Filter enabled	0 = Disabled, 1 = Enabled
166	Background Interval	<p>0 = 24 Hrs            1 = 12 Hrs            2 = 8 Hrs            3 = 6 Hrs            4 = 4 Hrs            5 = 2 Hrs            6 = Disable            Note: this parameter is deprecated; while it can still be read, writing to it will have no effect. Use parameter 144 instead.</p>
167	Service (COM1) Baud	Serial baud rate

168	Multidrop (COM2) Baud	0 = 1200 bps 1 = 2400 bps 2 = 4800 bps 3 = 9600 bps 4 = 14400 bps 5 = 19200 bps 6 = 38400 bps
169	Service Protocol	0 = EC9800
170	Multidrop Protocol	1 = Bayern-Hessen 2 = Advanced 3 = Modbus
171	AO1 Over Range	The Upper Concentration Range when Over-Ranging is enabled
172	AO2 Over Range	
173	AO3 Over Range	
174	AO1 Over-Ranging	0 = Over Ranging Disabled
175	AO2 Over-Ranging	1 = Over Ranging Enabled
176	AO3 Over-Ranging	2 = Over Ranging enabled and currently active
177	Heater Set Point	Cell Heater Set Point units in °C
178	PMT High Volt. Pot	High voltage pot setting
179	PMT Test LED Pot	PMT Test LED intensity controller POT
180	Last Power Failure	Time Stamp of the Last power fail (4 byte time stamp) Bit 31:26 ---- Year (0 – 99) Bit 25:22 ---- Month (1 – 12) Bit 21:17 ---- Date (1 – 31) Bit 16:12 ---- Hour (00 – 23) Bit 11:06 ---- Min (00 – 59) Bit 05:00 ---- Sec (00 – 59)
181	Inst Manifold Pres.	Manifold Pressure in S40 instruments (instantaneous)
182	Cell Press. (gas5)	Cell Pressure for Gas 5 (Nx)
183	Gas 4 <i>Inst.</i>	Calculated gas concentration currently displayed on front screen E.g. NH3
184	Gas 4 Avg.	Average of the readings (for Gas 4) of the last n minutes where n is the averaging period E.g. NH3
185	Gas 5 <i>Inst.</i>	Calculated gas concentration currently displayed on front screen E.g. Nx
186	NH3 Conv. Efficiency	
187	Cell/Lamp Duty Cycle	
188	Mirror T. Duty Cycle	
189	Flow Temp Duty Cycle	

190	Cooler T. Duty Cycle	
191	Conv Temp Duty Cycle	
192	CO Conv T Duty Cycle	
193	F/Scale Curr AO 1	20 mA Calibration value
194	F/Scale Curr AO 2	
195	F/Scale Curr AO 3	
196	Z Adj Curr AO 1	4 mA Calibration value
197	Z Adj Curr AO 2	
198	Z Adj Curr AO 3	
199	Ext Analog Input 1	The value of the external analog input after the multiplier and offset have been applied
200	Ext Analog Input 2	
201	Ext Analog Input 3	
202	Conv Set Point	Converter Set Point
203	Cal. Pressure 3	Calibration Pressure 3
204	PTF Correction (gas 3)	Pressure Temperature Flow Compensation Factor for third gas in multi-gas instruments.
205	Dilution Ratio	The current dilution ratio (default is 1.0)
206	Traffic Light	State of the status light: 0 = Green 1 = Amber 2 = Off (normally impossible) 3 = Red
207	Network Protocol	0 = EC9800 1 = Bayern-Hessen 2 = Advanced 3 = Modbus
208	Gas 4 Offset	An offset applied to Gas 4
209	O3 GEN Fine Pot	Ozone generator control, DAC controlled. DAC: 0..64535
210	O3 Gen Lamp Current	Units in mA
211	O3 GEN Coarse Pot	Repeat of parameter 209
212	Logging Period	The data logging period, in seconds (1.. 86400)
213	O3 Gen Coeff A	Ozone generator coefficients Note that Coeff D is parameter 127
214	O3 Gen Coeff B	
215	O3 Gen Coeff C	
216	Meas. Count	S60 measure count
217	Sig. Count 1	S60 signal counts
218	Sig. Count 2	



219	Sig. Count 3	
220	Sig. Count 4	
221	Signal Voltage	S60 signal voltage
222	LED Drive	S60 LED drive value
223	Third Instrument Gain	Only valid with an S44 variant set to multiple gains. Shows the third gas gain (Nx). Default is 1.0.
224	Legacy PTF Method	Only applies to S40 variants. 0 = new PTF calculation 1 = old PTF calculation inherited from ML This value was added to Build 10800 and defaults to 1.
225	Chassis Humidity	Only applies to S30 variants, and only on Rev P or later boards. The current humidity inside the instrument, in percentage.
226	Opto Strength	Only applies to Rev P or later boards. Optical signal strength.

This page is intentionally blank.

---

## Appendix B. EC9800 Protocol

The Serinus implements a subset of the 9800 instrument protocol. Only the basic commands of reading the concentration value and setting the instrument calibration state (measure, span or zero) are supported.

---

### B.1 Command Format

---

All commands are sent as ASCII strings. Fields are delimited by commas and the command ends with the normal return key (i.e. the TERMINATOR is either a <CR> or a <LF>). The DEVICE I.D. is the Serial ID assigned in the **Main Menu → Communications Menu → Serial Communication Menu**. If the instrument is not being used in a multi-drop connection, the DEVICE I.D. can be replaced with the string “???”.

---

### B.2 Commands

---

#### DCONC

Function: Sends the current instantaneous concentration data to the serial port.

Format: DCONC, {<DEVICE I.D.>} {TERMINATOR}

Device response: {GAS} <SPACE> {STATUS WORD} <CR><LF>

The GAS value is the concentration value in the current instrument units, expressed as a floating point number (i.e. 12.345). The STATUS WORD indicates the instrument status in hex (i.e. A01F) using the following format:

- Bit 15 = SYSFAIL (MSB)
- Bit 14 = FLOWFAIL
- Bit 13 = LAMPFAIL
- Bit 12 = CHOPFAIL
- Bit 11 = CVFAIL
- Bit 10 = COOLERFAIL
- Bit 9 = HEATERFAIL
- Bit 8 = REFFAIL
- Bit 7 = PS-FAIL
- Bit 6 = HV-FAIL
- Bit 5 = OUT OF SERVICE
- Bit 4 = Instrument is in zero mode
- Bit 3 = Instrument is in span mode
- Bit 2 = Unused
- Bit 1 = SET→PPM selected, CLEAR→MG/M3
- Bit 0 = reserved (LSB)

#### DSPAN

Function: Commands the instrument to enter span mode.

Format: DSPAN, {<DEVICE I.D.>} {TERMINATOR}

Device response: <ACK> if the instrument is able to perform the command, <NAK> if not.

### DZERO

Function: Commands the instrument to enter the zero mode.  
Format: DZERO, {<DEVICE I.D.>} {TERMINATOR}  
Device response: <ACK> if the instrument is able to perform the command, <NAK> if not.

### ABORT

Function: Commands the instrument to abort the current span/zero mode and return to measure mode.  
Format: ABORT, {<DEVICE I.D.>} {TERMINATOR}  
Device response: <ACK> if the instrument is able to perform the command, <NAK> if not.

### RESET

Function: Reboots the instrument (software reset).  
Format: RESET, {<DEVICE I.D.>} {TERMINATOR}  
Device response: <ACK>.

## Appendix C. Bayern-Hessen Protocol

The Serinus implements a limited subset of the Bayern-Hessen Network protocol. Only the ability to set the instrument calibration state (measure, span or zero) and read the gas concentrations are supported.

### C.1 Command Format

<STX><text><ETX>< bcc1><bcc2>

Where:

- <STX> ASCII Start of Text = 0x02 hex.
- <Text> ASCII text maximum length of 160 characters.
- <ETX> ASCII End of Text = 0x03 hex.
- <bcc1> ASCII representation of block check value MSB. (That is, the character “3” for 3, the character “F” for 15, etc.)
- <bcc2> ASCII representation of block check value LSB.

The block check algorithm begins with 0 and exclusive-OR’s each ASCII character from <STX> to <ETX> inclusive. This block check value is converted to ASCII format and sent after the <ETX> character.

#### Examples

This is an example of a valid Bayern-Hessen data request for an instrument that has a Serial ID of 97 (Serial ID assigned in the **Main Menu** → **Communications Menu** → **Serial Communication Menu**):

<STX>DA097<EXT>3A

The block check calculation is best shown by the following example:

**Table 22 – Bayern-Hessen Data**

Character	Hex Value	Binary	Block Check
<STX>	02	0000 0010	0000 0010
D	44	0100 0100	0100 0110
A	41	0100 0001	0000 0111
0	30	0011 0000	0011 0111
9	39	0011 1001	0000 1110
7	37	0011 0111	0011 1001
<ETX>	03	0000 0011	0011 1010

The binary value 0011 1010 corresponds to the hex value 3A. This value in ASCII forms the last two characters of the data request message.

Note: The I.D. of 97 is sent as the sequence 097. All I.D. strings must have three digits and must always be padded with ASCII zero characters.

This is an example of a valid command to put the unit in the manual span mode if the instrument has an ID of 843:

<STX>ST843 K<ETX>52

The block check operation is best shown with the following table:

**Table 23 – Block Check Operation**

Character	Hex Value	Binary	Block Check
<STX>	02	0000 0010	0000 0010
S	53	0101 0011	0101 0001
T	54	0101 0100	0000 0101
8	38	0011 1000	0011 1101
4	34	0011 0100	0000 1001
3	33	0011 0011	0011 1010
<SPACE>	20	0010 0000	0001 1010
K	4B	0100 1011	0101 0001
<ETX>	03	0000 0011	0101 0010

The binary block check value is 0101 0010 which is the hex value 52 as shown at the end of the command string.

## C.2 Commands

### DA

Return the current instantaneous concentration.

#### Command Format

<STX>{DA}{<kkk>}<ETX>< bcc1><bcc2>

Where:

kkk Device's ID. This field is optional, but if provided it must be padded with zeros to be 3 characters long. The value must match one of the following: the instrument's Bayern-Hessen ID, 000, or ??? (three question marks).

bcc1 First byte of the block check calculation.

bcc2 Second byte of the block check calculation.

## Device response

The instrument responds with a variable length string, depending on how many measured gasses have been assigned an ID above 0. The text between the [ ] will be repeated once for each reported gas.

```
<STX>{MD}{cc}[[<SP><kkk><SP><+nnnn+ee><SP><ss><SP><ff><SP><mmm><SP>eeeeee<SP>]<ETC><bcc1><bcc2>
```

Where:

<SP>	Space (0x20 hex).
cc	The number of gasses reported (0..5). The text in between the [ ] will be repeated once for each gas reported.
kkk	The Bayern-Hessen instrument ID.
+nnnn+ee	Gas concentration.
ss	Status byte (see table below for individual bits).
ff	Failure byte (see table below for individual bits).
mmm	Gas ID.
eeeeee	Ecotech instrument ID.
bcc1	First byte of the block check calculation.
bcc2	Second byte of the block check calculation.

**Table 24 – Status Bit Map**

Status Bit	Meaning if set to 1
0	Instrument off (this value is always set to 0).
1	Out of service.
2	Zero mode.
3	Span mode.
4	-
5	-
6	Units: 1 = Volumetric, 0 = Gravimetric.
7	Background mode (S30 and S50 family only).

**Table 25 – Failure Bit Map (Positive Logic)**

Failure Bit	Meaning if set to 1
0	Flow sensor failure.

Failure Bit	Meaning if set to 1
1	Instrument failure. Note that while the In Maintenance mode reports as an instrument failure with a red light on the front panel, for Bayern-Hessen this particular error is merely a status instead of a failure.
2	-
3	Lamp failure (S40 family only).
4	-
5	Cell heater failure (S30, S40 and S50 family only).
6	-
7	-

## ST

Set the instrument mode.

### Command Format

<STX>{ST}{< kkk>}<SP>{command}<ETC><bcc1><bcc2>

Where:

kkk	Device's Serial ID. This field is optional, but if provided it must be padded with zeros to be 3 characters long. The value must match one of the following: the instrument's Bayern-Hessen ID, 000, or ??? (three question marks).
Command	M, N or K for Measure, Zero or Span mode.
bcc1	First byte of the block check calculation.
bcc2	Second byte of the block check calculation.

### Device response

The device does not issue a response to this command.



## Appendix D. ModBus Protocol

The Serinus supports a limited Modbus implementation. The only function codes supported are 3 (read holding register) and 16 (write multiple registers). The Serial ID is assigned in the **Main Menu** → **Communications Menu** → **Serial Communication Menu**.

---

### D.1 Command Format

---

<Slave address><Function code><Start register (MSB)><Start register (LSB)><Register count (MSB)><Register count (LSB)><Write byte count><Write data><CRC (MSB)><CRC (LSB)>

Where:

Slave address	The instrument Serial ID. If the request is being made via TCP, this field is omitted.
Function code	3 (read) or 16 (write).
Start register	Specifies an Advanced Protocol IEEE index (refer to Table 21 to see what values are available and what index to specify for them). The ModBus index is calculated from the Advanced Protocol index via the following formula:  $\text{Modbus Index} = \text{Advanced Protocol Parameter List number} \times 2 + 256$
Register count	A single read command may request from 2 to 124 registers, which is to say from 1 to 62 values. The first index is specified by Start register; all following indexes are in sequential order. To read values that are not sequential requires using another read command. Note that the number of registers must be even, as each value is returned as a floating point value (4 bytes) and each register is a word (2 bytes).  A write command can only write a single IEEE value at a time. Thus for write commands this value must be 2.
Write byte count	This field is only supplied for a write request; it indicates the amount of bytes of data that will follow, and must be set to 4 (since only one value can be written at a time).
Write data	This field is only supplied for a write request. It is the value to be written, expressed in IEEE format. The “Endian” structure can be selected on the Modbus Serial Communications menu. Big Endian means that the MSB byte of the IEEE value is at the right end of the four bytes; Little Endian means it is at the left.
CRC	Calculated by the standard Modbus CRC method. If the request is being made via TCP, this field is omitted.

## D.2 Commands

---

### Read Holding Registers

The response to a read request is in the following format:

<Slave address>3<Register count (MSB)><Register count (LSB)><Data><CRC (MSB)><CRC (LSB)>

Where:

Slave address	As general command format.
Register count	As general command format.
Data	4 to 248 bytes of data, representing 1 to 62 floating point numbers in IEEE format. The “Endian” structure can be selected on the Modbus Serial Communications menu. Big Endian means that the MSB byte of the IEEE value is at the right end of the four bytes; Little Endian means it is at the left.
CRC	As general command format.

### Write Holding Register

The only supported use for this command is to set the instrument into a calibration state.

Where:

Start register MSB	1
Start register LSB	170
Register count	2
Write Data bytes	The IEEE representation of 0, 1, 2, or 3 0 puts the instrument into Measure mode (0,0,0,0) 1 puts the instrument into Cycle mode (63,128,0,0) 2 puts the instrument into Zero mode (64,0,0,0) 3 puts the instrument into Span mode (64,64,0,0)

The response to a write request is to return the first six bytes of the initiating write request.

### Error

An error will be returned in the following format:

<Slave address><Function code><Exception code><CRC (MSB)><CRC (LSB)>

Slave address	As general command format.
Function code	The initiating command’s function code + 128; so either 131 (read) or 144 (write).
Exception code	The error code (see table below).

CRC                                      As general command format.

**Table 26 – Modbus Error Codes**

Value	Error
1	Illegal Function
2	Illegal Data Address
3	Illegal Data Value
4	Slave Device Failure



POWERED BY ACOEM

**metone.com**

User manual subject to change without notice. Images used are for illustrative purposes only.  
All trademarks and registered trademarks are the property of their respective owners.  
© 2022 Acoem and all related entities. All rights reserved.