

USER MANUAL

GAS-1044

Ammonia Analyzer

NO, NO₂, NO_x, NH₃ Analyzer

Version 3.0



POWERED BY ACOEM

metone.com



POWERED BY ACOEM

Met One Instruments is now part of the Acoem Group. The Met One range of gas analyzers was originally developed by Acoem under the brand name Ecotech Serinus®.

For the purposes of expediting the availability of Met One gas analyzers to Met One customers around the world; Met One Instruments have chosen to use the original Ecotech Serinus® operating manual.

Although the name of the Met One instrument is different, the analyzer itself has remained unchanged and meets the strictest quality and performance requirements expected of Met One equipment. All the information presented in this manual is current, including analyzer specifications and operating principles.

Met One will update this manual to reflect the new branding convention in due course.

Table of Contents

Manufacturer’s Statement	10
Notice	10
Safety Requirements	11
Warranty.....	11
Service & Repairs	12
CE Mark Declaration of Conformity	13
Claims for Damaged Shipments and Shipping Discrepancies	14
Internationally Recognised Symbols on Ecotech Equipment.....	15
Manual Revision History	16
1. Introduction	17
1.1 Description	17
1.2 Specifications	17
1.2.1 Measurement	17
1.2.2 Calibration	17
1.2.3 Power.....	18
1.2.4 Operating Conditions.....	18
1.2.5 Communications.....	18
1.2.6 Physical Dimensions	19
1.3 Nomenclature	19
1.4 Background/Theory.....	21
1.4.1 Measurement Theory.....	21
1.4.2 Kalman Filter Theory.....	23
1.5 Instrument Description	24
1.5.1 Calibration Valve Manifold	24
1.5.2 Auxiliary Valve Manifold	24
1.5.3 Particulate Filters.....	24
1.5.4 NH ₃ Scrubbers.....	25
1.5.5 Delay Loop	25
1.5.6 Dryer	25
1.5.7 Ozone Generator	25
1.5.8 NO ₂ to NO Converter	25
1.5.9 External NH ₃ converter (thermal oxidiser).....	26
1.5.10 Pressure Sensor PCA	26
1.5.11 Reaction Cell	26
1.5.12 Optical Bench.....	26
1.5.13 Pneumatic Tubing	27
1.5.14 Main Controller PCA	27
1.5.15 Power Supply	27
1.5.16 On/Off Switch	27
1.5.17 Communications.....	27
2. Installation	31
2.1 Initial Check.....	31
2.2 Installation Notes	32
2.3 Instrument Set-up	34

2.3.1	Pneumatic Connections	34
2.3.2	Power Connections	35
2.3.3	Communications Connections	36
2.3.4	Instrument Set-Up.....	36
2.4	Transporting/Storage.....	37
3.	Operation.....	39
3.1	Warm-Up	39
3.2	Measurement	39
3.3	General Operational Information	40
3.3.1	Keypad & Display	40
3.3.2	Home Screen	42
3.4	Menus & Screens.....	43
3.4.1	Quick Menu	43
3.4.2	Main Menu.....	44
3.4.3	Analyser State Menu	44
3.4.4	Status Menu	45
3.4.5	Temperature Menu	46
3.4.6	Pressure & Flow Menu	46
3.4.7	Voltage Menu.....	47
3.4.8	General Settings Menu.....	47
3.4.9	Measurement Settings Menu.....	48
3.4.10	Calibration Menu	48
3.4.11	Pressure Calibration Menu.....	50
3.4.12	Service Menu	51
3.4.13	Diagnostics Menu.....	51
3.4.14	Digital Pots Menu	52
3.4.15	Valve Menu	53
3.4.16	Tests Menu.....	54
3.4.17	Digital Input Test Menu.....	54
3.4.18	Digital Output Test Menu.....	54
3.4.19	Calculation Factors Menu.....	55
3.4.20	Communications Menu	56
3.4.21	Data Logging Menu	56
3.4.22	Serial Communication Menu.....	56
3.4.23	Analog Input Menu	57
3.4.24	Analog Output Menu	58
3.4.25	Digital Input Menu	59
3.4.26	Digital Output Menu	60
3.4.27	Network Menu	61
3.4.28	Bluetooth Menu	62
3.4.29	Advanced Menu	62
3.4.30	Hardware Menu	63
3.4.31	Parameter Display Menu.....	63
4.	Communications.....	65
4.1	RS232 Communication.....	65
4.2	USB Communication	66
4.3	TCP/IP Network Communication (optional)	67
4.3.1	Network Setup	68
4.3.2	Port Forwarding on Remote Modem/Router Setup.....	68

4.3.3	Setup Airodis to Communicate with Serinus	69
4.4	Digital/Analog Communication	70
4.4.1	Analog Outputs	70
4.4.2	Analog Inputs	71
4.4.3	Digital Status Inputs	72
4.4.4	Digital Status Outputs	72
4.5	Logging Data	73
4.5.1	Configure Instrument Internal Logging	73
4.6	Using Airodis Software to Download Data	74
4.6.1	Connecting the Instrument to Your PC	74
4.6.2	Installing Airodis	77
4.6.3	Configuring Airodis	77
4.7	Serinus Remote App/Bluetooth	83
4.7.1	Installation	83
4.7.2	Connecting to the Instrument	84
4.7.3	Instrument Control	85
4.7.4	Real-Time Plot	86
4.7.5	Download	87
4.7.6	Get Parameters	88
4.7.7	Preferences	89
5.	Calibration	91
5.1	Overview	91
5.2	Pressure Calibration	93
5.2.1	Full Pressure Calibration	93
5.2.2	Ambient Point Pressure Calibration	94
5.3	Zero Calibration	95
5.3.1	Calibration Port	95
5.3.2	Sample Port	96
5.3.3	Background Air Port	96
5.4	Span Calibration	97
5.4.1	Conditioning the Ammonia (NH ₃) Sample and Calibration Lines	97
5.4.2	Calibration Port	97
5.4.3	Sample Port	98
5.4.4	Manual Instrument Gain and Offset Adjustments	98
5.5	Precision Check	99
5.6	Multipoint Precision Check	100
5.7	NO ₂ to NO Converter Efficiency	101
5.7.1	Single Point NO ₂ to NO Converter Efficiency Check	103
5.7.2	Multipoint NO ₂ to NO Converter Efficiency Adjustment	104
5.8	NH ₃ Converter Efficiency	105
5.8.1	Single Point NH ₃ Converter Efficiency Check	105
5.8.2	Multipoint NH ₃ Converter Efficiency Adjustment	106
5.9	High Pressure Zero/Span Valve (Option)	108
5.9.1	Single Pressurised Calibration Option	108
5.9.2	Dual Pressurised Calibration Option	110
6.	Service	113
6.1	Maintenance Tools	113
6.2	Maintenance and Calibration Schedule	114

6.3	Maintenance Procedures.....	116
6.3.1	Particulate Filter Replacement.....	116
6.3.2	Clean Fan Filter.....	116
6.3.3	DFU Replacement.....	117
6.3.4	NH ₃ Scrubber Replacement.....	117
6.3.5	Leak Check.....	118
6.3.6	Replacing the PMT Desiccant Pack.....	119
6.3.7	Cleaning the Reaction Cell.....	120
6.3.8	Clean Pneumatics.....	122
6.3.9	Pressure Sensor Check.....	122
6.3.10	Ozone Generator Maintenance.....	124
6.4	Bootloader.....	126
6.4.1	Display Help Screen.....	127
6.4.2	Communications Port Test.....	127
6.4.3	Updating Firmware.....	127
6.4.4	Erase All Settings.....	127
6.4.5	Start Analyser.....	127
7.	Troubleshooting.....	129
7.1	Flow Fault.....	132
7.2	Noisy/Unstable Readings.....	133
7.3	Converter Temperature Failure.....	134
7.4	Flow Block Temperature Failure.....	135
7.5	Reaction Cell Temperature Failure.....	136
7.6	USB Memory Stick Failure.....	137
7.7	Ecotech Service Support Files.....	138
8.	Optional Extras.....	141
8.1	Rack Mount Kit (PN E020116).....	141
8.2	High Pressure Zero/Span Valves.....	145
9.	Parts List and Schematics.....	147
9.1	Serinus Accessories Kit.....	147
9.2	Maintenance Kit.....	147
9.3	Consumables.....	148
9.4	Instrument Parts List.....	149
9.5	Plumbing Schematic – (D020018).....	150
9.6	Block Wiring Schematic – (D020104).....	151
9.7	Ozone Generator Assembly – (H011107).....	152
9.8	Optical Bench Assembly – (H011200).....	153
9.9	Manifold Block Assembly – (H011302).....	154
9.10	Calibration Manifold Assembly – (H010013-01).....	155
9.11	Valve Assembly – (H010042).....	156

List of Figures

Figure 1 – Simple Pneumatic Diagram	21
Figure 2 – NH ₃ Calculation	23
Figure 3 – Internal Components Diagram	24
Figure 4 – Ecotech Tygon Tubing	27
Figure 5 – Opening the Instrument	31
Figure 6 – Example Setup for S44 Monitoring System	33
Figure 7 – Instrument Back Panel	34
Figure 8 – Installation of USB Memory Key	38
Figure 9 – Switching the Battery On/Off	38
Figure 10 – Front Panel	40
Figure 11 – Home Screen	42
Figure 12 – Communication Ports	65
Figure 13 – Multidrop RS232 Cable Example	66
Figure 14 – Example of Typical Network Setups	67
Figure 15 – Example of Network Menu Setup	68
Figure 16 – Port Forwarding Example	69
Figure 17 – LAN Network Set-Up (Airodis)	69
Figure 18 – WAN Network Set-Up (Airodis)	70
Figure 19 – 25 Pin Rear Panel PCA (Default Jumpers Highlighted)	72
Figure 20 – External 25 Pin I/O Individual Pin Descriptions	73
Figure 21 – Installing Driver Software (Device Manager)	74
Figure 22 – Update Driver Popup	75
Figure 23 – Update Driver Popup (Directory Location)	75
Figure 24 – Installing Driver Confirmation Prompt	76
Figure 25 – Successful Driver Installation	76
Figure 26 – Airodis Workspace Manager	78
Figure 27 – Adding a New Station	78
Figure 28 – New Station Connection	79
Figure 29 – Station Configuration (Channel List)	80
Figure 30 – Error Status Notification	80
Figure 31 – Downloading Data	81
Figure 32 – Download Data Status	81
Figure 33 – Data Visibility	82
Figure 34 – Exporting Data	82
Figure 35 – Data Download Complete	83
Figure 36 – Downloading the App from Google Play Store	84
Figure 37 – Bluetooth Pairing Request	84
Figure 38 – Showing or Hiding the NumPad	85
Figure 39 – Switching Analysers	86
Figure 40 – Real-Time Plot	87
Figure 41 – Plot of Downloaded Data	88
Figure 42 – Directory Settings	89

Figure 43 – Logs Format	89
Figure 44 – Colour Theme Settings.....	90
Figure 45 – Example of a Calibration System	91
Figure 46 – Setting the Ambient Set Point	95
Figure 47 – Multipoint Calibration Results Example	101
Figure 48 – Single High Pressure Calibration Option.....	108
Figure 49 – Dual High Pressure Calibration Option	110
Figure 50 – Minifit Extraction Tool – (T030001).....	113
Figure 51 – Orifice/Sintered Filter Removal Tool – (H010046)	113
Figure 52 – Leak Test Jig – (H050069)	114
Figure 53 – Air Monitoring Test Equipment Kit (AMTEK) - Customisable	114
Figure 54 – Removing Plunger.....	116
Figure 55 – Removing the Fan Filter.....	117
Figure 56 – DFU Filter	117
Figure 57 – NH3 Scrubber.....	118
Figure 58 – Removing the Desiccant Pack.....	120
Figure 59 – Remove Reaction Cell	121
Figure 60 – Optical Filter Removal and Cleaning.....	122
Figure 61 – Test Point Location	123
Figure 62 – Typical Test Point Reading of Cell Pressure with Vacuum Connected to Exhaust Port....	123
Figure 63 – Typical Test Point Reading of Manifold Pressure Sensor	124
Figure 64 – Remove Ozone Generator from Instrument	125
Figure 65 – Cleaning of Glass Tube.....	126
Figure 66 – Zero Flow Fault Troubleshooting Flow Chart	132
Figure 67 – Noisy or Unstable Readings Troubleshooting Flow Chart	133
Figure 68 – Converter Alarm Troubleshooting Flow Chart.....	134
Figure 69 – Valve Manifold Temperature Alarm Troubleshooting Flowchart	135
Figure 70 – Reaction Cell Temperature Failure Troubleshooting Flow Chart	136
Figure 71 – USB Memory Stick Failure	137
Figure 72 – USB Memory Stick File Structure.....	139
Figure 73 – Separate Rack Slides	141
Figure 74 – Assemble Inner Slide on Chassis.....	142
Figure 75 – Rack Mount Ears Fitted to Instrument	142
Figure 76 – Attach Rack Mount Adaptors to Outer Slides.....	143
Figure 77 – Test Fit the Rack Slide Assembly Into Your Rack	143
Figure 78 – Attach Slides to Front of Rack.....	144
Figure 79 – Slide Clips.....	145

List of Tables

Table 1 – Manual Revision History	16
Table 2 – Measurements Times	39
Table 3 – Digital Output States	60
Table 4 – Analog Outputs	70
Table 5 – New Station Setup	79
Table 6 – Maintenance Schedule	114
Table 7 – Troubleshoot List	129
Table 8 – Serinus Accessories Kit – (H010136).....	147
Table 9 – Serinus 44 Maintenance Kit – (E020206).....	147
Table 10 – Serinus 44 Consumables	148
Table 11 – Spare Parts List Serinus 44.....	149
Table 12 – Advanced Protocol Parameter List	157
Table 13 – Bayern-Hassen Data	168
Table 14 – Block Check Operation	169
Table 15 – Bayern-Hassen Protocol Commands	169
Table 16 – Bit Map	170
Table 17 – Bit Map (positive logic)	171

List of Equations

Equation 1 – Chemiluminescence Reaction for NO	21
Equation 2 – NO ₂ Calculation	22
Equation 3 – NH ₃ Calculation	22
Equation 4 – Calculation for NO ₂ Converter Efficiency of the NO _x path.....	102
Equation 5 – Calculation for NO ₂ Converter Efficiency of the NX path	102
Equation 6 – Calculation for NH ₃ Converter Efficiency	105

Manufacturer's Statement

Thank you for selecting the Ecotech Serinus 44 Ammonia & Oxides of Nitrogen Analyser.

The Serinus series is the next generation of Ecotech designed and manufactured gas analysers. The Serinus 44 will perform NO, NO₂, NO_x, NH₃ and N_x measurements over a range of 0-20 ppm with a lower detectable limit of 0.4 ppb.

This User Manual provides a complete product description including operating instructions, calibration and maintenance requirements for the Serinus 44 Ammonia & Oxides of Nitrogen Analyser. This manual is valid for the most recent version of the Serinus 44 which includes the new Autoranging Power Supply, Main Controller PCA and Rear Panel PCA.

Reference should also be made to the relevant local standards which should be used in conjunction with this manual. Some of these standards are listed in this manual.

If, after reading this manual you have any questions or you are still unsure or unclear on any part of the Serinus 44 please do not hesitate to contact Ecotech or your local Ecotech distributor.



Please help the environment and recycle the pages of this manual when you have finished using it.

Notice

The information contained in this manual is subject to change without notice. Ecotech reserves the right to make changes to equipment construction, design, specifications and /or procedures without notification.

Copyright © 2014. All rights reserved. Reproduction of this manual, in any form, is prohibited without the written consent of Ecotech Pty Ltd.



CAUTION

Hazardous voltages exist within the instrument. Do not remove or modify any of the internal components or electrical connections whilst the main power is on.

Ensure the main power lead is maintained in a safe working condition.

The instruments lid should be closed during normal operation to comply with EMC regulations.

Safety Requirements

To reduce the risk of personal injury caused by electrical shock, follow all safety notices and warnings in this documentation.

If the equipment is used for purposes not specified by Ecotech, the protection provided by this equipment may be impaired.

Replacement of any part should only be carried out by qualified personnel, using only parts specified by Ecotech as these parts meet stringent Ecotech quality assurance standards. Always disconnect the power source before removing or replacing any components.

Warranty

This product has been manufactured in an ISO 9001/ISO 14001 facility with care and attention to quality.

The product is subject to a 24-month warranty on parts and labour from date of shipment. The warranty period commences when the product is shipped from the factory. Lamps, filters and other consumable items are not covered by this warranty.

Each instrument is subjected to a vigorous testing procedure prior to despatch and will be accompanied with a parameter list and a multipoint precision check, thereby enabling the instrument to be installed and ready for use without any further testing.

Service & Repairs

Our qualified and experienced technicians are available to provide fast and friendly service between the hours of 8:30am – 5:00pm AEST Monday to Friday. Please contact either your local distributor or Ecotech regarding any questions you have about your instrument.

Service Guidelines

This manual is designed to provide the necessary information for the setup, operation, testing, maintenance and troubleshooting of your instrument.

Should you still require support after consulting the documentation, we encourage you to contact your local distributor for support.

To contact Ecotech directly, please e-mail our Technical Support Services group at support@ecotech.com. To speak with someone directly:

Please dial 1300 364 946 if calling from within Australia

Please dial +61 3 9730 7800 if calling from outside of Australia

Please contact Ecotech and obtain a Return Material Authorisation (RMA) number before sending any equipment back to the factory. This allows us to track and schedule service work and to expedite customer service. Please include this RMA number when you return equipment, preferably both inside and outside the shipping packaging. This will ensure you receive prompt service.

When shipping instrumentation, please also include the following information:

- Name and phone number
- Company name
- Shipping address
- Quantity of items being returned
- Model number/s or a description of each item
- Serial number/s of each item (if applicable)
- A description of the problem and any fault-finding completed
- Original sales order or invoice number related to the equipment

Shipping Address:

Attention Service Department

Ecotech Pty Ltd

1492 Ferntree Gully Road,

Knoxfield, VIC, Australia 3180.

CE Mark Declaration of Conformity

This declaration applies to the Serinus 44 Ammonia & Oxides of Nitrogen Analyser as manufactured by Ecotech Pty Ltd of 1492 Ferntree Gully Rd, Knoxfield, VIC, Australia 3180. The instrument to which this declaration relates is in conformity with the following European Union Directives:

Council Directive of 15 December 2004 on the approximation of the laws of Member States relating to electromagnetic compatibility (2004/108/EC)

The following standard was applied:

EN 61326-1:2013 Electrical equipment for measurement, control and laboratory use – EMC requirements – Part 1: General requirements

Immunity Requirements EN 61326-1

IEC-61000-4-2 Electrostatic discharge immunity
IEC-61000-4-3 Radiated RF immunity
IEC-61000-4-4 Electrical fast transient burst immunity
IEC-61000-4-5 Surge immunity
IEC-61000-4-6 Conducted RF immunity
IEC-61000-4-11 Voltage dips and interruption immunity

Electromagnetic Compatibility EN 61326-1

CISPR-11 Radiated RF emission measurements
CISPR-11 Mains terminal RF emission measurements
IEC-61000-3-3 Mains terminal voltage fluctuation measurements
IEC-61000-3-2 Power frequency harmonic measurements

Council Directive of 12 December 2006 on the harmonisation of the laws of member states relating to electrical equipment designed for use within certain voltage limits (2006/95/EC)

The following standard was applied:

EN 61010-1:2013 Safety requirements for electrical equipment, for measurement control and laboratory use (**3rd edition**) – Part 1: General requirements

For protection against:

- Electric shock or burn
- Mechanical Hazards
- Excessive temperature
- Spread of fire from the equipment
- Effects of fluids and fluid pressure
- Effects of radiation including laser sources and sonic and ultrasonic pressure, liberated gases, explosion and implosion.

Claims for Damaged Shipments and Shipping Discrepancies

Damaged Shipments

Inspect all instruments thoroughly on receipt. Check materials in the container/s against the enclosed packing list. If the contents are damaged and/or the instrument fails to operate properly, notify the carrier and Ecotech immediately.

The following documents are necessary to support claims:

- Original freight bill and bill of lading
- Original invoice or photocopy of original invoice
- Copy of packing list
- Photographs of damaged equipment and container

You may want to keep a copy of these documents for your records.

Please refer to the instrument name, model number, serial number, sales order number and your purchase order number on all claims.

You should also:

- Contact your freight forwarder for an insurance claim
- Retain packing material for insurance inspection

Shipping Discrepancies

Check all packages against the packing list immediately on receipt. If a shortage or other discrepancy is found, notify the carrier and Ecotech immediately. Ecotech will not be responsible for shortages against the packing list unless they are reported within seven days.

Contact Details

Head Office

1492 Ferntree Gully Road, Knoxfield, VIC Australia 3180

Phone: +61 (0)3 9730 7800 Fax: +61 (0)3 9730 7899





Email: info@ecotech.com

Service: service@ecotech.com

Support: support@ecotech.com

www.ecotech.com

Internationally Recognised Symbols on Ecotech Equipment

	Protective conductor terminal	IEC 60417-5017
	Alternating current	IEC 60417-5032
	Caution, hot surface	IEC 60417-5041
	Caution, risk of danger. Refer to accompanying documents	ISO 7000-0434
	Caution, risk of electric shock	ISO 3864-5036

Manual Revision History

Manual PN: M010034

Current revision: 3.0

Date released: 1 December 2014

Description: User Manual for the Serinus 44 Ammonia & Oxides of Nitrogen Analyser

This manual is the full user manual for the Serinus 44 Ammonia & Oxides of Nitrogen Analyser. This manual contains all relevant information on theory, specifications, installation, operation, maintenance and calibration. Any information that cannot be found within this manual can be obtained by contacting Ecotech.

- This manual uses cross reference links extensively. The hot keys below will greatly reduce the amount of time scrolling between references: You can access the links by pressing the following:
 - > CTRL + LEFT MOUSE CLICK: Move to link location
- You can switch between links by pressing the following:
 - > ALT + LEFT ARROW KEY: Returns you to previous Link
 - > ALT + RIGHT ARROW KEY: Swaps back

Table 1 – Manual Revision History

Edition	Date	Summary
1.0	August 2010	Initial Release
1.1	November 2010	Delay field added CE information added Battery replacement procedure
2.0	January 2013	Format Updated Updated to suit Serinus 2.0
2.3	August 2014	Auto-Ranging Power Supply Added Main Controller and Rear Panel PCAs changed.

1. Introduction

1.1 Description

The Ecotech Serinus 44 NO/NO₂/NO_x/NH₃/N_x uses Gas Phase Chemiluminescence Detection to perform continuous analysis of nitric oxide (NO), total oxides of nitrogen (NO_x), nitrogen dioxide (NO₂) ammonia (NH₃) and total oxides of nitrogen + ammonia (N_x).

This section will describe the specifications of the instrument as well as the main components and techniques used to obtain stable gas concentration readings.

1.2 Specifications

1.2.1 Measurement

Range

0-20 ppm autoranging

Lower detectable limit: 0.4 ppb, with Kalman filter active

Precision

0.4 ppb otherwise 0.5% of reading, whichever is greater

Linearity

±1% of full scale

Response Time

25 seconds to 90%

Sample Flow Rate

~0.3 slpm per channel (~0.9 slpm total flow for all channels)

1.2.2 Calibration

NO Zero Drift

Temperature dependant: 0.1 ppb per °C

24 hours: < 0.4 ppb

7 days: < 1.0 ppb

NO Span Drift

Temperature dependant: 0.1% per °C

7 days: < 1.0% of reading

1.2.3 Power

- Operating voltage
100-240VAC, 50 to 60 Hz (Autoranging)
- Power Consumption
265 VA max (typical at start-up)
190 VA after warm-up

1.2.4 Operating Conditions

Ambient Temperature Range

0 °C to 40 °C (32 °F to 104 °F)

Sample Pressure Dependence

5% change in pressure produces less than a 1% change in reading

Maximum altitude: 3000m above sea level

1.2.5 Communications

Analog Output

- Menu selectable current output of 0-20 mA, 2-20mA or 4-20mA.
- Voltage output of 0 to 5 V, with menu selectable zero offset of 0%, 5%, or 10%.
- Voltage output of 0 to 10 V (configured using jumpers (JP3) on rear panel PCA).
- Range: 0 to full scale from 0-0.05 ppm to 0-20 ppm with 0%, 5%, and 10% offset.

Analog Input

- Three analog voltage inputs (0-5VDC) CAT I rated.

Digital Output

- RS232 port #1: Normal digital communication or termination panel connections.
- RS232 port #2: Multidrop port used for multiple instrument connections on a single RS232.
- USB port connection on rear panel.
- 25 pin connector with discrete status and user control.
- USB memory stick (front panel) for data logging, event logging, parameter and configuration storage.
- Eight Digital Outputs, open collector max 400mA each @ 12VDC (max total output 2A).
- Eight Digital Inputs, 0-5VDC, CAT I rated.

1.2.6 Physical Dimensions

Case Dimensions

Rack length (front to rear):	597 mm (23.5")
Total length (with latch release):	638 mm (25.1")
Chassis width:	418 mm (16.5")
Front panel width:	429 mm (16.9")
Chassis height:	163 mm/Uses 4RU (6.4")
Front panel height:	175 mm (6.9")
Weight:	23.6 kg

1.3 Nomenclature

NO:	Nitrogen oxide or nitric oxide.
NO ₂ :	Nitrogen dioxide.
NO _x :	A generic term for mono-nitrogen oxides NO and NO ₂ .
NH ₃ :	Ammonia
N _x	A generic term for mono-nitrogen oxides NO and NO ₂ and Ammonia
Span:	A gas sample of known composition and concentration used to calibrate/check the response of the instrument.
Zero:	Zero calibration uses zero air (NO _x /NH ₃ scrubbed ambient air) to calibrate/check the zero response of the instrument.
Background Cycle:	Removes unwanted signal from the measurement signal. This is accomplished by pre-reacting the sample gas with ozone outside the reaction cell. The pre-reacted gas is drawn into the reaction cell where this signal is stored as the background signal. This background measurement is used to correct the sample measurement by subtracting the background signal from the measurement signal. Background cycle can be described as a dynamic zero where unwanted signals generated from the photomultiplier tube (detector) due to internal offsets (dark current) or unwanted cell luminescence's are removed.
Multipoint Precision Check:	A procedure to verify the linearity of the instrument.
Calibration:	The process of adjusting the instrument to ensure that it is measuring the correct concentration.

Zero Drift:	The changes in instrument response to zero pollutant concentration over time.
Zero Air:	Is purified air in which the concentration of NO is <0.5 ppb and NO ₂ is <0.5 ppb with water vapour of less than 10% RH. Sufficient purified air can be obtained by passing dry ambient air through an activated charcoal scrubber, a Purafil scrubber and a particulate filter.
External Span Source:	Span gas that is delivered via an external accredited cylinder containing NO in balance with N ₂ (e.g. NATA/NIST).
Sample Air:	Sample air is defined as the sample before it has entered the reaction cell, as distinguished from the exhaust air.
Exhaust Air:	Exhaust air is the sample air after it has passed through the reaction/measurement/detection cell and is moving towards being expelled from the instrument.
ID and OD:	These are measurements of tubing, ID is the internal diameter of tubing, and OD is the outer diameter.
Multidrop:	A configuration of multiple instruments connected via the same RS232 cable.
Photomultiplier Tube:	A highly sensitive device which can detect extremely low levels of light (photons) and multiply the electrical signal to a point where it can be accurately measured. These are often called PMT's for short.
Bootloader:	A program that checks whether the current firmware is valid and executes the instrument start-up. The Bootloader can be entered by pressing the '+' key on the front keypad during the first ½ second after power on, and following the prompts. The Bootloader enables various low level recovery tools, including updating the main firmware from a USB stick.
PCA:	Printed Circuit Assembly. An electronic circuit mounted on a printed circuit board to perform a specific electronic function.
slpm:	Standard litres per minute. This is the flow referenced to standard temperature and pressure conditions. For the purposes of this manual, all flows are referenced to 0 °C and 101.3 kpa (1 atm).

1.4 Background/Theory

Oxides of Nitrogen (NO_x) are the product of endothermic reactions within combustion engines and cause significant environmental pollution.

The main source of NO_x emissions is from hydrocarbon combustion such as automobile engines or the burning of coal for power production. These pollutants are harmful to humans and create ozone gas (O_3) and acid rain. NO_x is a major component of the smog found in industrial cities and is harmful to people with respiratory diseases such as asthma.

Ammonia (NH_3) is mainly generated from agricultural sources, with hot-spots found particularly near intensive pig and poultry farms. Ammonia pollution causes both acidification of soils and a decrease in the richness of plant species.

1.4.1 Measurement Theory

The measurement of the $\text{NO}/\text{NO}_2/\text{NO}_x/\text{NH}_3/\text{N}_x$ is performed using the gas phase chemiluminescence method:

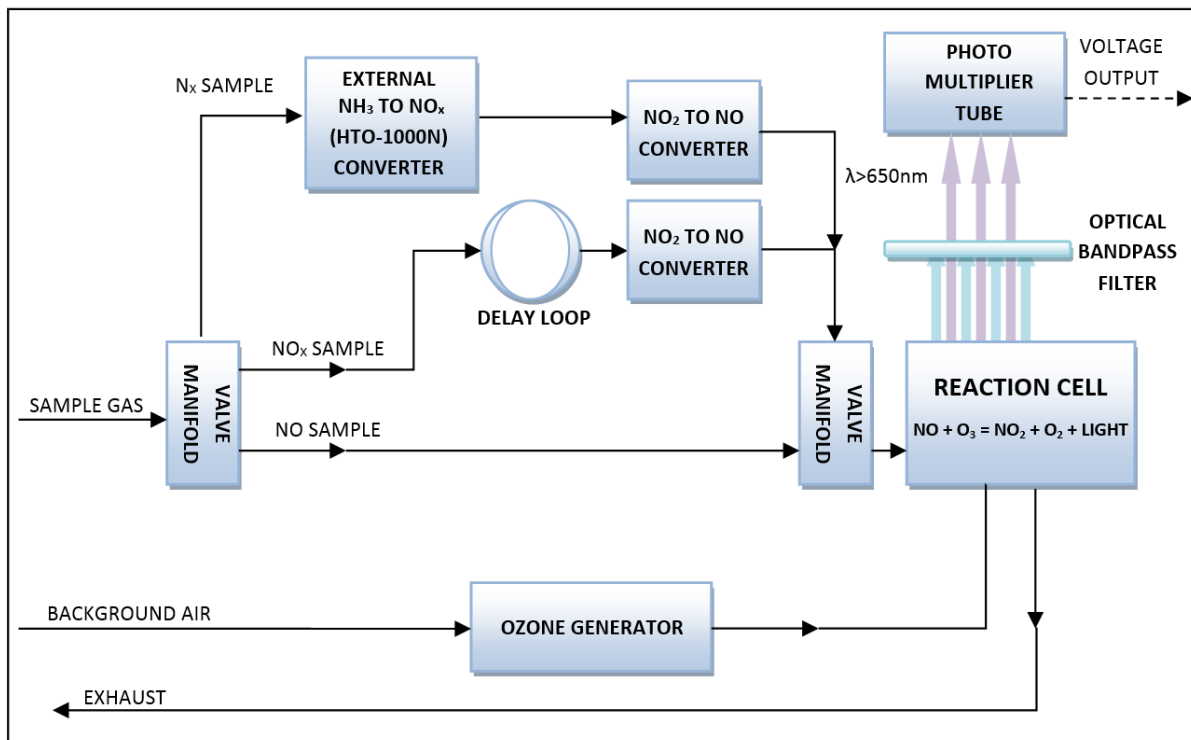
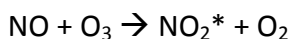

Figure 1 – Simple Pneumatic Diagram

- Sample air is drawn into the reaction cell via three separate (alternating) paths; the NO , NO_x and N_x paths.
- The first path is drawn directly to the reaction cell. NO gas present in the sample reacts with ozone according to the following reaction.



Equation 1 – Chemiluminescence Reaction for NO

Note: The chemiluminescence reaction is between O₃ and NO only; not NO₂ or NH₃.
Photons are emitted by the activated NO₂^{*}.

- This reaction releases energy in the form of chemiluminescent radiation, which is filtered by the optical Bandpass filter and detected by the photomultiplier tube (PMT).
- The level of chemiluminescence detected is directly proportionally to the NO in sample.
- The second path is drawn through a delay loop and the NO₂ to NO converter (NO_x path) such that it reaches the reaction cell after the first path measurement period. At which point the NO_x measurement (the combined concentration of NO and NO₂) is taken.
- The concentration of NO₂ is calculated by subtracting the NO measurement from NO_x measurement.

$$\text{NO}_x = \text{NO} + \text{NO}_2 \quad \text{or} \quad \text{NO}_2 = \text{NO}_x - \text{NO}$$

Equation 2 – NO₂ Calculation

- The third path is drawn through the external NH₃ converter (N_x path) which converts NH₃ into NO and NO₂. This passes through an internal NO₂ to NO converter to convert any NO₂ into NO.
- The concentration of NH₃ is calculated by subtracting the NO_x measurement from N_x measurement

$$\text{N}_x = \text{NH}_3 + \text{NO}_x \quad \text{or} \quad \text{NH}_3 = \text{N}_x - \text{NO}_x$$

Equation 3 – NH₃ Calculation

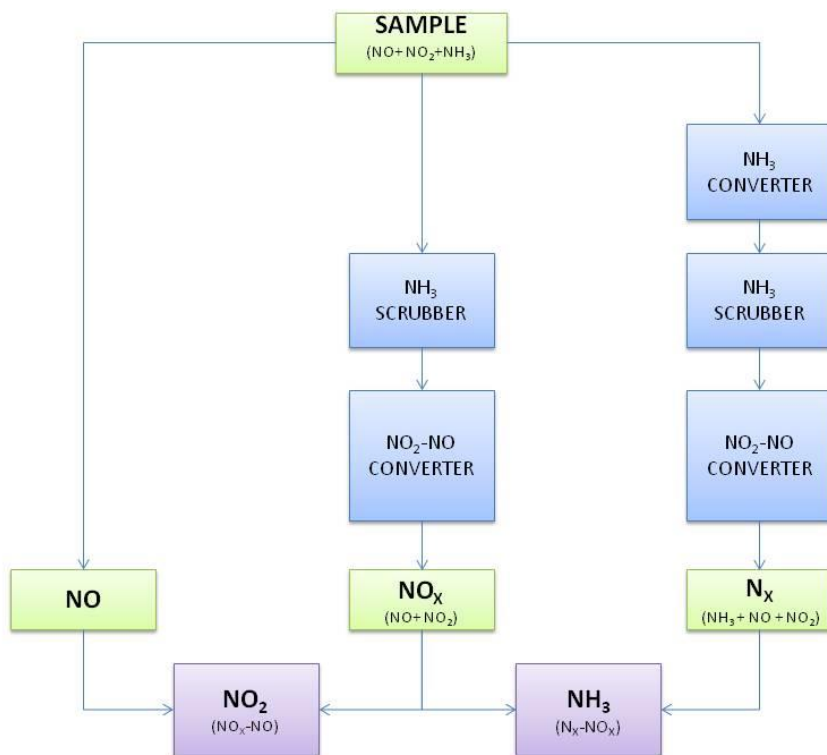

Figure 2 – NH₃ Calculation

1.4.2 Kalman Filter Theory

The digital Kalman filter provides an ideal compromise between response time and noise reduction for the type of signal and noise present in ambient air instruments.

The Kalman filter enhances measurements by modifying the filter time base variable, depending on the change rate of the measured value. If the signal is changing rapidly, the instrument is allowed to respond quickly. When the signal is steady, a long integration time is used to reduce noise. The system continuously analyses the signal and uses the appropriate filtering time.

1.5 Instrument Description

The major components of the Serinus 44 are described below:

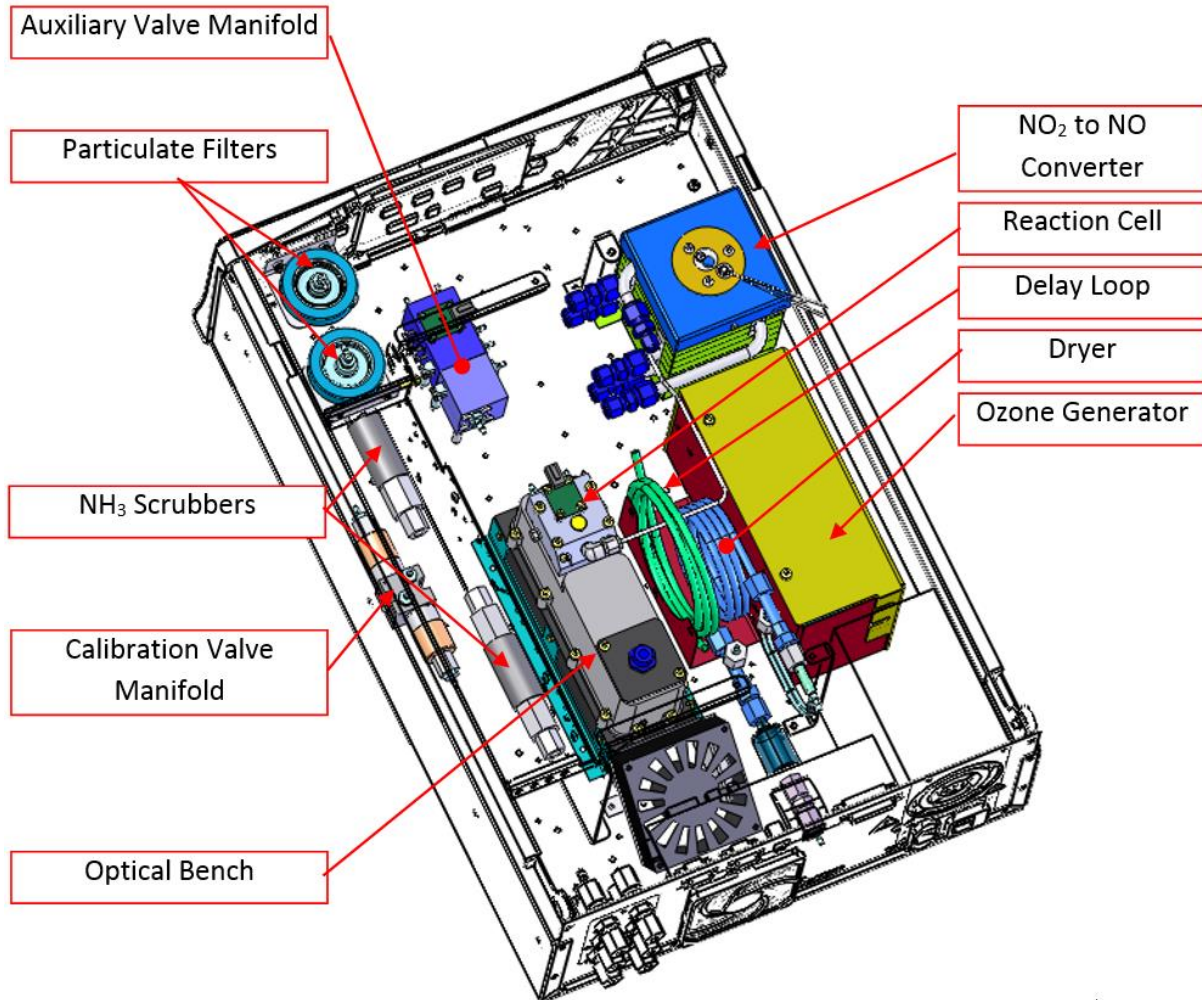

Figure 3 – Internal Components Diagram

1.5.1 Calibration Valve Manifold

The calibration valve manifold switches between sample, calibration and background gas.

1.5.2 Auxiliary Valve Manifold

The auxiliary valve manifold switches sample gas between NO, NO_x and N_x flow paths along with background and bypass flow paths.

1.5.3 Particulate Filters

The particulate filters are Teflon 5 micron (μm) filters with a diameter of 47mm. These filters eliminate all particles larger than 5 μm that could interfere with sample measurement. One filter is for the NO and NO_x sample paths and the other the N_x sample path.

1.5.4 NH₃ Scrubbers

NH₃ Scrubbers are placed in the measurement paths to remove any NH₃ before measurement of the NO (or converted NO), as NH₃ may interfere with the reaction in the NO₂ to NO converter and reaction cell.

The scrubber is filled with granular phosphoric acid which reacts with the ammonia to form ammonium salts which are left behind in the scrubber as the other gases pass through unaffected. The scrubber will eventually become blocked and less efficient through normal use and as it is a consumable item will need replacing.

1.5.5 Delay Loop

In order to measure the NO and NO_x sample at the same point in time in the reaction cell, a single sample is split into two paths: NO and NO_x. Each sample path is measured sequentially. The delay loop is installed in the NO_x path and along with the restriction of the NO to NO₂ converter is used to extend the time the sample takes to reach the reaction cell. Tubing lengths in specific areas of the instrument are critical and must not be changed. Changing these lengths will affect the timing of the sample paths.

There is no delay loop for the N_x channel, as the length of tubing to the external converter, combined with further delays inside the HTO-1000N, make it impractical to sample the exact same gas sample.

1.5.6 Dryer

The dryer is constructed of Nafion tubing and is designed to remove water vapour from ambient air that is then used by the ozone generator. The water is absorbed and moves through the walls of the tubing, evaporating into the surrounding air. The remaining gas is unaffected. The flow control is performed by utilising a critical orifice.

1.5.7 Ozone Generator

The ozone generator is a corona discharge ozone source driven by an ignition coil. Dry air is drawn into the discharge tube via an orifice and ionised by a high voltage electrode. This yields O₃ from the reaction $3\text{O}_2 \rightarrow 2\text{O}_3$. The ionisation takes place in the confines of a glass tube with the electrode mounted on the outside. The amount of ozone generated is controlled by varying the energy to the discharge tube. The ozone flow rate is 80 sccm with an ozone concentration of 6000-8000 ppm (approximately).

1.5.8 NO₂ to NO Converter

The NO₂ to NO converter assembly has 4 major components.

- NO_x converter coil
- N_x converter coil
- Ozone destroyer coil
- Heated core with Thermocouple (~325°C)

The NO_x and N_x converter coils uses high temperature (~325°C) and a catalyst to convert any NO₂ in the sample to NO. To obtain accurate and stable results, the converter must operate at above 96% efficiency.

The ozone destroyer coil uses high temperature (~325°C) and a catalyst to remove ozone from the instrument's exhaust.

The heated core is controlled by the main controller PCA and kept at a stable temp ~325°C with feedback from the thermocouple.

1.5.9 External NH₃ converter (thermal oxidiser)

Ecotech recommends the use of the HTO 1000N thermal oxidizer. HTO 1000N employs both catalytic and thermal principles in the conversion of NH₃ to NO and NO₂. The converter efficiency is normally between 88-94% at a temperature of 680°C. The HTO 1000N is connected to the Serinus 44 instrument through the Auxiliary ports, on the rear of the instrument (refer to Section 2.3.1). For more information on the HTO 1000N refer to the HTO 1000 manual. If you are using your own external converter refer to its manual for further information.

1.5.10 Pressure Sensor PCA

There are two pressure sensor PCA's that are used to check for flow and correct the instrument readings for pressure variations. One is located on the auxiliary valve manifold, upstream of the critical orifice (**Manifold Pressure**) and the other is located on the reaction cell downstream of the critical orifice (**Cell Pressure**).

1.5.11 Reaction Cell

Reaction cell

The reaction cell is where O₃ and NO mix to create a chemiluminescence reaction, which emits photons. A portion of this light is filtered to a specific wavelength region (>665nm) by the optical bandpass filter and measured by the PMT.

Optical Bandpass Filter

The optical bandpass filter is constructed of coloured glass that only allows the transmission of light above 665nm. It is used to prevent measurement of interfering compounds.

1.5.12 Optical Bench

Photomultiplier (PMT)

The PMT detects the amount of light reaching its sensors. The selective filtering of light reaching the PMT allows direct measurement of NO in the cell.

PMT Cooler

The PMT cooler ensures that the PMT is operated at a constant 13°C. This reduces the measurement noise of the PMT.

PMT High Voltage Supply and Preamplifier Module

This is a single component within the PMT housing. Its function is to supply high voltage to the PMT and to amplify the photocurrent signal from the PMT.

1.5.13 Pneumatic Tubing

The pneumatic tubing inside this instrument is specially designed for use in Ecotech Serinus instruments. It has the flexibility of Tygon tubing with the added inner sheath of Teflon to prevent contamination of the sample. Care should be taken when removing and inserting the tubing into the barbed fittings.

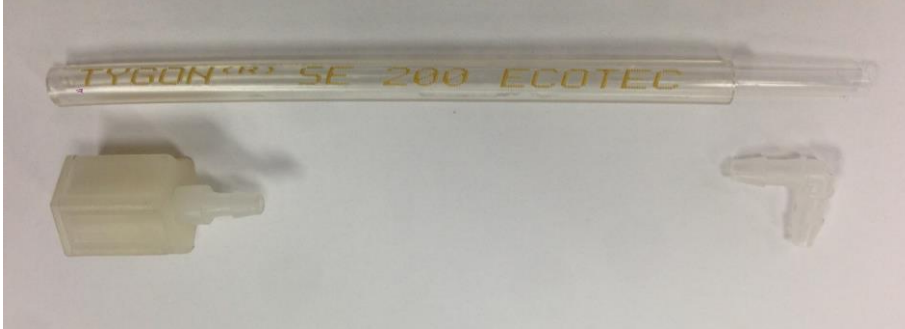

Figure 4 – Ecotech Tygon Tubing

1.5.14 Main Controller PCA

The main controller PCA controls all the processes within the instrument. As well as the on-board microprocessor, it contains a battery backed clock, calendar, analog to digital converters and many other circuits for signal processing and control. The ambient pressure and chassis temperature sensors are also located on this board. The main controller PCA is located above all other components within the instrument. It pivots on hinges to allow access to the components underneath. The current revision of the main controller PCA for which this manual applies, has many differences to previous revisions, highlighted by the many vacant component locations on the PCA.



CAUTION

Never place objects on top of the main controller PCA as it may result in damage.

1.5.15 Power Supply

The power supply is a self-contained unit housed in a steel case designed to meet all the relevant safety and EMC requirements. This new revision of power supply is different to the previous revision as there is no need to set the operating voltage switch because it is autoranging.

The output of the power supply provides +12V, +5V, -12V and +3.3V to the instrument.

1.5.16 On/Off Switch

The on/off switch is located on the back panel (bottom right facing the rear of the instrument). It is part of the power supply.

1.5.17 Communications

Communication between the instrument and either a data logger, laptop or network can be performed with the following communication connections located on the back panel (refer to Figure 7). These connections can be used for downloading data, onsite diagnostics, maintenance and firmware upgrades.

RS232 #1

This port is designed to be used for simple RS232 communication.

RS232 #2

This port is designed to be used for simple RS232 communication or in multidrop configuration.

USB

This port can be used for instrument communications with equipment through a standard USB port.

TCP/IP (optional)

This port is best used for remote access and real-time access to instruments when a network is available to connect with.

External I/O Port

The analog/digital port sends and receives analog/digital signals to other devices. These signals are commonly used to activate gas calibrators or for warning alarms.

Analog Outputs

The instrument is equipped with a maximum of three analog outputs for each measured gas. The outputs are menu selectable; voltage output (0-5VDC) or current output (0-20, 2-20 or 4-20mA). The current output can also be configured as a voltage output of 0 to 10V, by configuring the jumpers (JP3) on the rear panel PCA.

Analog Inputs

The instrument is also equipped with three analog voltage inputs (0-5VDC CAT 1) with resolution of 15 bits plus polarity.



CAUTION

Exceeding these voltages can permanently damage the instrument and void the warranty.

Digital Status Inputs

The instrument is equipped with eight logic level inputs (0-5VDC CAT 1) for the external control of zero/span calibration sequences.



CAUTION

Exceeding these voltages can permanently damage the instrument and void the warranty.

Digital Status Outputs

The instrument is equipped with eight open collector outputs, which will convey instrument status conditions and warning alarms such as no flow, sample mode, etc.



CAUTION

Exceeding 12VDC or drawing greater than 400mA on a single output or a total greater than 2A across the eight outputs can permanently damage the instrument and void the warranty.

Bluetooth

This allows for remote access of the instrument to any Android device with the Serinus remote application installed. It uses Bluetooth to control the instrument, view parameters, download data and construct real-time graphs.

This page is intentionally blank

2. Installation

2.1 Initial Check

Packaging

The Serinus 44 is transported in packaging which is specifically designed to minimise the effects of shock and vibration during transportation. Ecotech recommends that the packaging be kept if there is a likelihood that the instrument is going to be relocated.

Note: The red plastic caps that seal the pneumatic connections during transport must be removed prior to operation.

Opening the Instrument

Check the interior of the instrument with the following steps:

1. Undo the screws located in the rear panel.
2. Open the chassis lid by releasing the latch (pressing the button) located on the front panel in the top left-hand corner, slide the lid backwards.
3. To completely remove; slide the lid backwards until the rollers line up with the gaps in the track and pull the lid upwards to remove from the instrument (refer to Figure 5).
4. Check that all pneumatic and electrical connectors are connected. If not, reconnect.
5. Check for any visible and obvious damage. If damage exists contact your supplier and follow the instructions in (Claims for Damaged Shipments) and (Shipping Discrepancies) at the front of this manual.

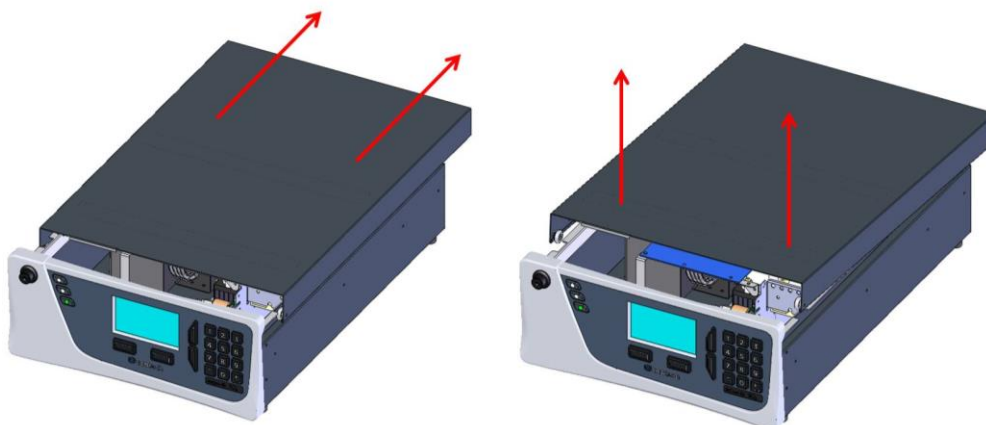

Figure 5 – Opening the Instrument

Items Received

With the delivery of the Serinus 44, the user should have received the following:

- Ecotech Serinus 44 analyser PN: E020044
- Green Ecotech Resources USB Stick PN: H030137-01
- End Caps PN: B010002
- Manual PN: M010034 (hardcopy optional)
- USB Memory Stick PN: H030021
- USB Cable PN: COM-1440
- Power Lead (120V)* USA PN: C040007
- Power Lead (240V)* Australia PN: C040009
- Europe PN: C040008
- UK PN: C040010

*The power lead received depends on the mains supply of the country (120V or 240V).

Note: Check all these items have been delivered undamaged. If any item appears damaged, please contact your supplier before turning the instrument on.

2.2 Installation Notes

When installing the instrument the following points must be taken into account:

- The instrument should be placed in an environment with minimal dust, moisture and variation in temperature.
- For best results the instrument should be located in a temperature and humidity controlled environment (air conditioned shelter). An enclosure temperature of 25-27°C is optimum.
- Whether in a rack or placed on a bench, the instrument should not have anything placed on top of it or touching the case.
- Instruments should be sited with easy access to the front panel (instrument screen/USB memory stick) and to the back panel (communication ports/pneumatic connections).
- It is recommended that the sample line be as short as possible to reduce loss of sample to tubing walls. Ecotech strongly recommends the use of a high-flow sample manifold with a very short sample line between the manifold and the instrument.
- Do not pressurize the sample line under any circumstances. Sample should be drawn through the instrument under atmospheric pressure. This should be achieved by using an external vacuum pump connected to the exhaust port of the instrument.
- When supplying span gas, ensure the flow is approximately 1.5 slpm and excess is sufficiently vented.
- Ammonia is an extremely viscous or “sticky” gas and to reduce the impacts of this, all of the external tubing connections should be kept as short as possible. Ecotech strongly recommends

the use of 1/8" glass-lined SS tubing or passivated/deactivated SS tubing for all gas cylinder connections. Teflon, FEP or ideally MFA tubing is suitable for use with sample lines.

- Ensure the external converter is mounted close to the instrument to reduce tubing lengths.
- A new ammonia monitoring system will require a long time for all of the sample and calibration lines to become properly conditioned. Ecotech recommends the first time a system is installed to run NH₃ gas through the system for several hours to properly condition the lines.
- Suitable NH₃ gas standards can be more difficult to source than a standard NO cylinder. The moisture content of the cylinder can have a very large impact on the apparent concentration and will adversely affect the converter efficiency. Gas standards should be as dry as possible to ensure correct concentration is maintained.
- NH₃ gas cylinders must be kept in a stable temperature environment to ensure the concentration is stable. In colder temperatures, the NH₃ gas can stick to the walls of the gas cylinder and change the apparent concentration.
- Regulators used for the NH₃ cylinder should be dedicated to avoid contamination of other gas systems.

Note: The power on/off switch is accessible from the rear of the instrument only. Install the instrument so that the on/off power switch is accessible.

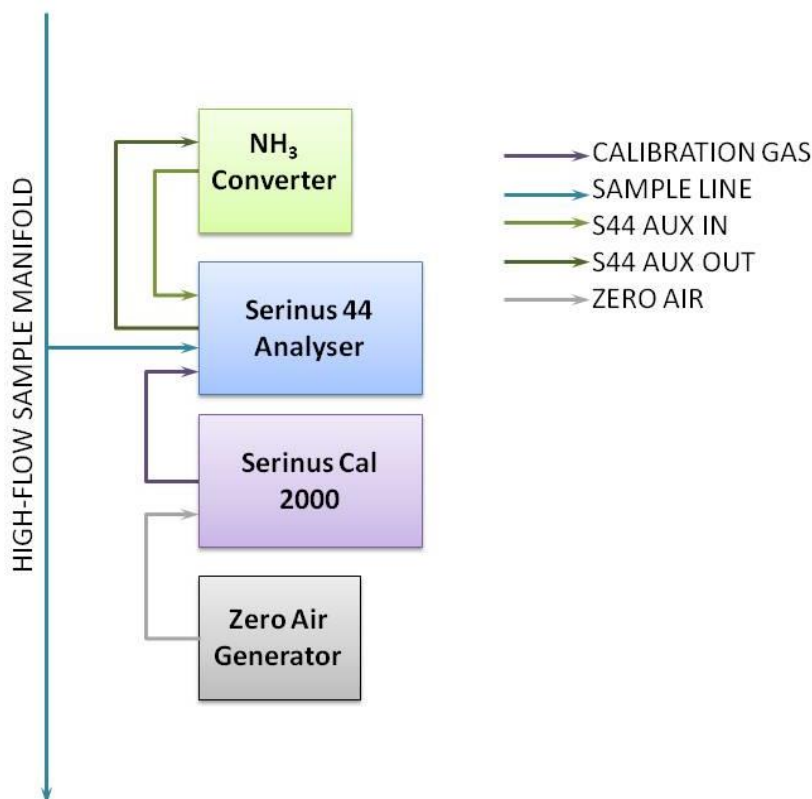

Figure 6 – Example Setup for S44 Monitoring System

2.3 Instrument Set-up

After installing the instrument the following procedures should be followed to ready the instrument for monitoring:

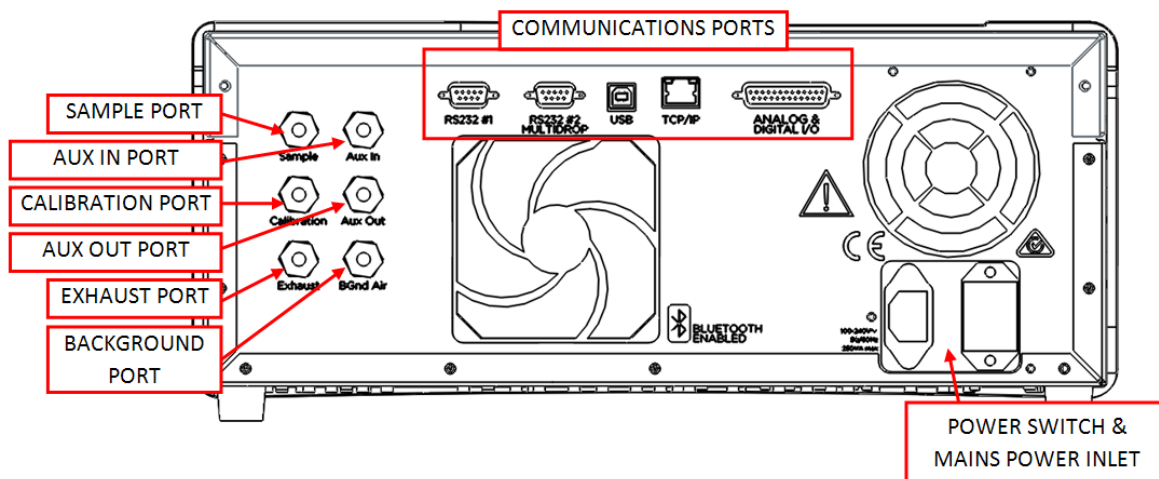

Figure 7 – Instrument Back Panel

2.3.1 Pneumatic Connections

The Serinus 44 has six pneumatic ports on the back panel of the instrument: the Sample Port, the Calibration Port, the Exhaust Port, the Auxiliary In port, the Auxiliary Out Port and the Background Air Port. All tubing and fittings used should follow the instructions below:

- Must be made of Teflon® FEP material, Kynar®, stainless steel, glass or any other suitably inert material.
- Sample line should be no more than two meters in length with 1/8 inch ID and 1/4 inch OD.
- Sample inlet pressure should not exceed 5 kPa above ambient pressure.
- Tubing must be cut squarely and any burrs removed.
- Remove the inlet port nut and insert the tubing through the back of the nut with the tube extending one inch through the front.
- Place the tubing into the port until it hits the tube stop inside fitting.
- Place the nut back onto the fitting and tighten clockwise until finger tight.
- Nuts should be re-tightened when instrument reaches operating temperature.

Sample Port

The sample port must be connected to an ambient source of sample air. When using a sample manifold the Serinus requires at least 1.5 slpm delivered to the sample manifold (1 slpm for measurement plus approximately 50% excess).

Calibration Port

The calibration port can be connected to the span/zero sources. It is recommended that a gas dilution calibrator (Ecotech's Serinus Cal 2000) be used with a cylinder of ammonia (NH₃) and nitrogen oxide (NO) to deliver precise concentrations of NH₃ and NO. The GPT function of the gas dilution calibrator will also be required for testing the converter efficiency.

Note: All connections to this port should not exceed ambient pressure. A vent is required for excess span gas.

Exhaust Port

The exhaust port is where the reacted sample, calibration gases, background air and bypass flows are exhausted from the instrument. The exhaust port should be connected to the vacuum pump using ¼" OD tubing. The P030004 240V vacuum pump (P030005 110V) available from Ecotech, should be used to provide the required vacuum and flow for one Serinus 44 analyser.



CAUTION

Ammonia & Oxides of nitrogen are toxic gases. It is recommended that exhaust air is expelled into an unoccupied area, as it contains trace levels of oxides of nitrogen. The exhaust must be a suitable distance from the sample inlet to avoid influencing the ambient measurements.

Background Port

The background port is used to supply air to the ozone generator via the dryer within the instrument.

Auxiliary in port

The Auxiliary In port (AUX In) brings air in from the external converter to the N_x path. Tubing from the outlet of the external converter is connected to the Aux in port on the instrument.

Auxiliary out port

The Auxiliary Out port (AUX Out) takes sample air from the instrument and delivers it to the external converter. Tubing is connected to the inlet of the external converter from the AUX Out port.

2.3.2 Power Connections



CAUTION

When connecting the mains power to the instrument, the following must be adhered to otherwise the safety and the reliability of the instrument may be compromised.

- A three pin mains power lead with a protective earth conductor **MUST** be used.
- The mains power outlet (wall socket) must be in the range of 100-240 VAC, 50 to 60 Hz.
- The mains power outlet must be protected by an earth leakage protection circuit.

- Connect the instruments power lead into the mains power outlet and turn the power switch on.

2.3.3 Communications Connections

There are a number of ways to communicate with the instrument. Use the supplied Airodis software to access the instrument and download data. The Airodis software is supplied on the green Ecotech resources USB stick provided with this instrument.

RS232 #1

Connect this port to a data logger (such as WinAQMS) with an RS232 cable.

RS232 #2

Connect the RS232 cable from the instrument to a computer or data logger in a multidrop formation.

Note: When using multidrop ensure each instrument is given a unique **Serial ID**.

USB

Connect a standard type B USB cable (supplied with the instrument) to this port.

TCP/IP (optional)

Plug in an ethernet cable (this cable should be attached to a network).

Analog/Digital

This port is used to send and receive analog and digital signals. It is normally used to connect with a gas calibrator or to activate alarm signals.

Each instrument contains eight digital inputs, eight digital outputs, three analog inputs and three analog outputs.

Bluetooth

Connection is enabled using Ecotech's Serinus Remote Android Application.

Use the Serinus Remote Android Application to access instrument and download data. It is available for download directly from the Google Play Store. Search for "Ecotech Serinus Remote".

2.3.4 Instrument Set-Up

1. Open the lid and ensure that the USB memory stick is installed (refer to Figure 8).
2. Check that the battery is turned on at the main controller PCA (refer to Figure 9).
3. Turn on the instrument and allow the warm-up procedure to complete (refer to Section 3.1).
4. Set the time and date (refer to Section 3.4.8).
5. Set the digital filter to the desired setting (refer to Section 3.4.9).
6. Set the internal data logging options (refer to Section 3.4.21).
7. Set the analog/digital inputs and outputs settings (refer to Section 3.4.25 and Section 3.4.26).

8. Perform a pressure sensor check (refer to Section 6.3.9).
9. Perform a leak check (refer to Section 6.3.5).
10. Leave the instrument to warm-up and stabilise for two-three hours.
11. Ensure the sample lines have been properly conditioned by sampling NH₃ calibration gas for several hours prior to calibration.
12. Perform a NO_x span calibration (refer to section 5.4)
13. Follow the procedure for a multipoint precision check (refer to Section 5.5)
14. Perform an NH₃ converter efficiency check (refer to section 5.8)
15. The instrument is now ready for operation.

2.4 Transporting/Storage

Transporting the Serinus should be done with great care. It is recommended that the packaging the Serinus was delivered in should be used when transporting or storing the instrument.

When transporting or storing the instrument the following points should be followed:

1. Turn off the instrument and allow it to cool down.
2. Remove all pneumatic, power and communication connections.
3. If storing over a long period (six months) turn the battery off by switching the DIP switch (S1) on the main controller PCA (refer to Figure 9).
4. Remove the instrument from the rack.
5. Replace the red plugs into the pneumatic connections.
6. Remove the USB memory stick and pack with instrument (refer to Figure 8).
7. Place the instrument back into a plastic bag with desiccant packs and seal the bag (ideally the bag supplied upon delivery).
8. Place the instrument back into the original foam and box it was delivered in. If this is no longer available find some equivalent packaging that provides protection from damage.
9. The instrument is now ready for long term storage or transportation.

Note: After transport or storage, the instrument must be set-up and calibrated (Refer to Section 2.3.4).



Figure 8 – Installation of USB Memory Key

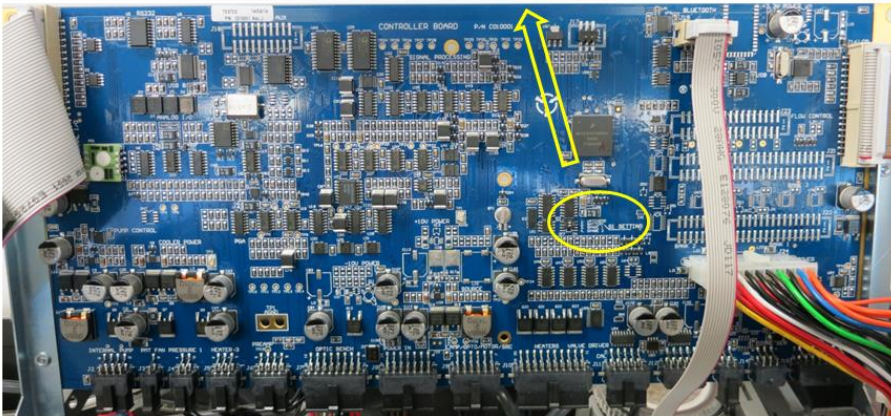

Figure 9 – Switching the Battery On/Off

3. Operation

3.1 Warm-Up

When the instrument is first turned on it must go through a period of adjustment and calibration. No measurements are taken during this warm-up period.

The following activities occur during warm-up:

Adjust High Voltage

The high voltage digital pot is adjusted to set the high voltage supply to the PMT for optimal range and performance.

Converter is Cold/Warm/Hot

The instrument progressively increases the temperature of the NO₂ to NO converter until it reaches the desired temperature of 325°C. When heating from cold the NO₂ converter will take approximately 60 minutes to reach the desired temperature. When the converter reaches 250°C the ozone generator will be switched on and analysis of NO/NO₂/NO_x/NH₃/N_x will begin.

The NH₃ converter temperature is maintained by the external converter and assumed to take a similar time to the internal NO₂ to NO converter to reach operational temperature.

After this warm-up has completed the instrument will immediately begin making measurements (refer to Section 3.2).

3.2 Measurement

The Serinus 44 NO_x Analyser is a five channel monitoring instrument that measures sample air through three different flow paths. These three paths are used to measure NO, NO_x and N_x. From these measurement cycles two calculations are performed to get measurements of NO₂ (difference between NO and NO_x) and NH₃ (difference between NO_x and N_x).

First a background is performed to determine the level of fluorescence without NO present, thus removing any background noise from the signal.

The instrument measures NO, NO_x and N_x in sequence. It performs this cycle five times before doing another background. The sample fill immediately after a background is longer than usual, to clear the measurement cell. One full cycle takes one minute and forty five seconds to complete.

Table 2 – Measurements Times

Instrument State	Duration (seconds)	Description
Background Fill	8	Cell fills with background air.
Background Meas	3	Background air is measured.
NO Sample Fill	3 *+4	Cell fills with NO sample. * The first sample fills after a background is longer.

Instrument State	Duration (seconds)	Description
NO Sample Meas	3	NO sample is measured
NO _x Sample Fill	3	Cell fills with NO _x sample
NO _x Sample Meas	3	NO _x sample is measured
N _x Sample Fill	3	Cell fills with N _x sample
N _x Sample Meas	3	N _x sample is measured

3.3 General Operational Information

3.3.1 Keypad & Display

The instrument is operated with the use of four sets of buttons:

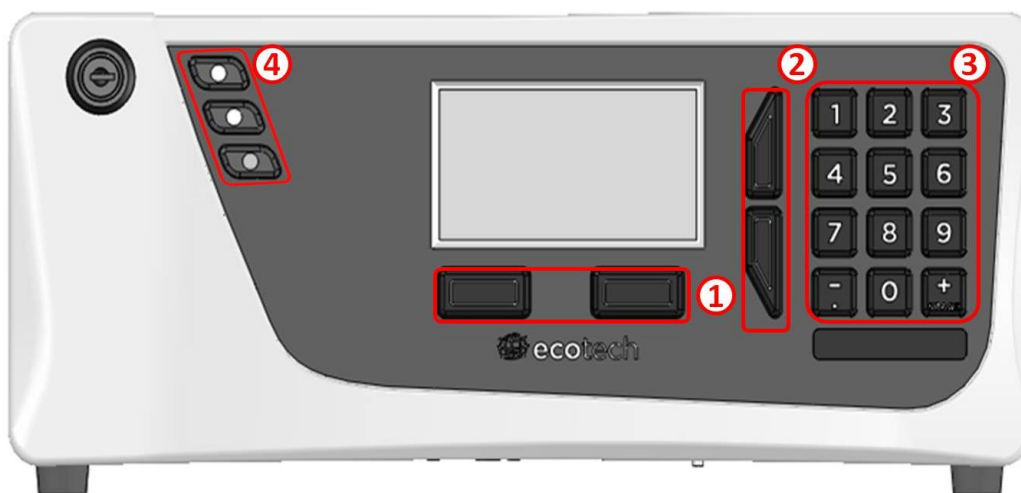

Figure 10 – Front Panel

Selection Buttons (1)

The selection buttons will perform the function specified directly above it on the screen. Generally this involves opening a menu, editing a value, accepting or cancelling an edit or starting an operation.

Scrolling Buttons (2)

The scrolling buttons allow users to scroll up and down through menus or selection boxes. The scrolling buttons are also used to scroll side to side through editable fields such as: Dates, Times, Numbers etc.

On the home screen these buttons are used for adjusting the screen contrast. Press and hold the up button to increase contrast; press and hold the down button to decrease.

Keypad (3)

The keypad contains the numbers 0-9, a decimal point/minus key ($\bar{-}$) and a space/plus key ($\bar{+}$).

In the few cases where letters can be entered, the number keys act like a telephone keypad. Every time a number key is pressed, it cycles through its choices. The up/down arrow keys scroll through all the numbers and the entire alphabet.

1 = 1 or space

2 = 2, A, B, C, a, b, c

3 = 3, D, E, F, d, e, f

4 = 4, G, H, I, g, h, i

5 = 5, J, K, L, j, k, l

6 = 6, M, N, O, m, n, o

7 = 7, P, Q, R, S, p, q, r, s

8 = 8, T, U, V, t, u, v

9 = 9, W, X, Y, Z, w, x, y, z

0 = 0 or space

The ($\overset{+}{SPACE}$) and key ($\bar{\cdot}$) button functions depend on context. When editing a floating point number, the key ($\bar{\cdot}$) inserts a negative sign if the editing cursor is at the start of the number and negative signs are allowed. Otherwise it moves the decimal place to the current cursor location. The ($\overset{+}{SPACE}$) key inserts a positive sign if the cursor is at the start of the number; otherwise it enters a space. For non-floating point numbers, these keys usually increment or decrement the current value by 1. When editing the month field of a date, the ($\overset{+}{SPACE}$) and ($\bar{\cdot}$) key change the month.

Instrument Status Light Buttons (4)

Located in the top left corner, these lights indicate the status of the instrument as a whole.

- A red light indicates that the instrument has a major failure and is not functioning.
- An orange light indicates there is a minor problem with the instrument, but the instrument may still take measurements reliably.
- A green light indicates that the instrument is working and there are no problems.

In the case of an orange or red light enter the **Status Menu** to find which components are failing (refer to Section 3.4.4) or pressing the orange or red light when illuminated will bring up a pop up box with a full list of current faults.

Pressing the green status light button at any time will cancel any open edit box or menu and return the user to the home screen.

If no instrument status lights are on and the keypad is backlit, this indicates that the instrument is running the bootloader. The screen will also indicate that it is in the bootloader menu.

3.3.2 Home Screen

The home screen is composed of seven parts: readings (1), error/status line (2), instrument activity line (3), selection buttons (4), time/date (5), concentration units (6) and USB status (7).

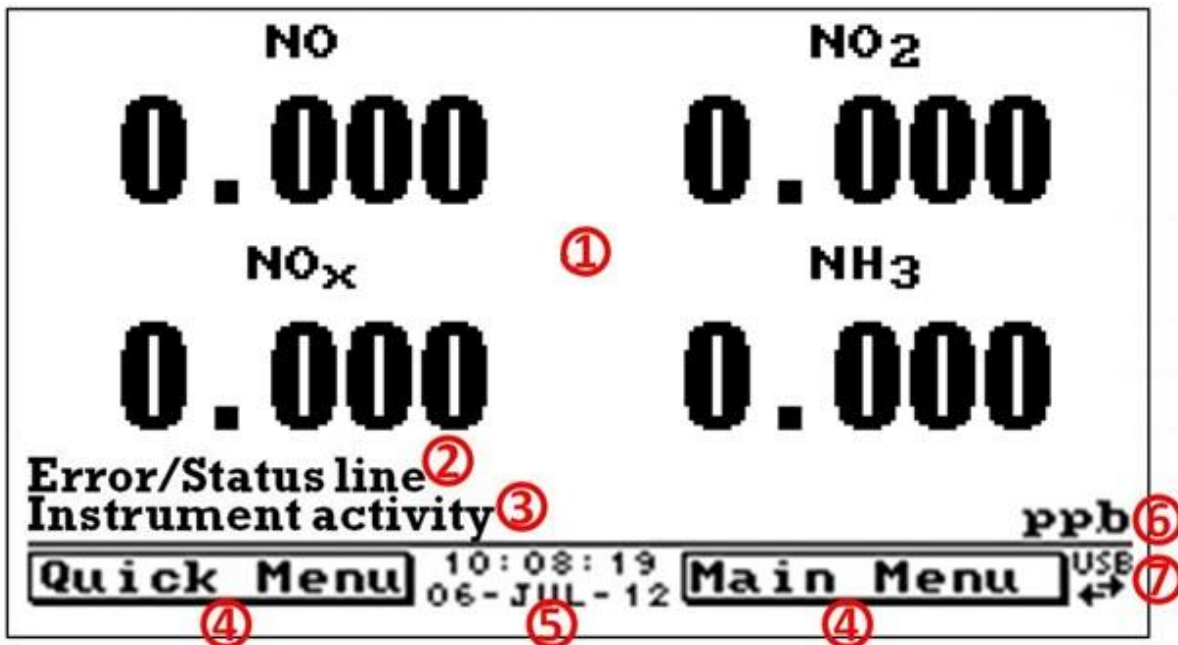

Figure 11 – Home Screen

Readings (1)

Displays the concentration being measured in real-time. The display can be configured to show just the instantaneous data or the instantaneous and average data (refer to Section 3.4.8 **Home Screen**).

Error/Status Line (2)

The error/status line provides users with information on any problems the instrument may have. It displays the highest priority error or status condition contained in the **Status Menu** (refer to Section 3.4.4).

The N_x measurement will be displayed on this line if there are no errors to report.

Instrument Activity (3)

This line shows what function the instrument is currently performing. Generally, it will show three groups of actions: Warm-up, Measurement or Calibration.

Selection Buttons (4)

These buttons are used on the home screen to enter one of two menus. The **Quick Menu** (refer to Section 3.4.1) contains all information and features necessary for scheduled maintenance. The **Main Menu** (refer to Section 3.4.2) contains all information and fields available to users and is generally only used during initial set-up and diagnostics.

Time and Date (5)

The time and date are displayed in between the menu buttons at the bottom of the screen.

Concentration Units (6)

The instrument units are displayed in the bottom right hand corner of the display.

USB Detection (7)

A USB symbol will be displayed in the bottom right corner when the USB memory stick is plugged in (the USB socket is behind the front panel). If the USB symbol is not shown, the USB memory stick should be inserted. Underneath the USB symbol arrows may be displayed which indicates data transfer. The USB memory stick must not be removed whilst the arrows are visible.

Note: To safely remove the USB memory stick, navigate to the **Quick Menu** and use the **Safely Remove USB Memory Stick** function (refer to Section 3.4.1).

3.4 Menus & Screens

The menu system is divided into two sections, the **Quick Menu** and the **Main Menu** selectable from the **Home Screen**. The **Quick Menu** contains all information and operations necessary during scheduled maintenance visits. The **Main Menu** contains all fields that are accessible to users. It provides information on component failures and measurement parameters as well as editable fields and test procedures.

In general, editable parameters are displayed in bold font. Non-editable information is displayed in a thin font. Some parameters may become editable based on the state of the instrument.

For example, the manual calibration type and mode can only be changed when the instrument has finished the warm-up process.

3.4.1 Quick Menu

The **Quick Menu** contains all the maintenance tools in one easy to use screen. It allows operators to perform calibrations, check important parameters and review the service history.

Span Calibrate NOx This field is used to perform a span calibration and should be only used when a known concentration of span gas is running through the measurement cell and the reading is stable.
Activating the span calibrate field for a named gas will open a dialog box. Enter the concentration of the span gas that the instrument is sampling and press **Accept**.

Event Log This field enters a screen with a log of all the events that the instrument has performed. These events include errors and warnings. This log is stored on the removable USB memory stick.
The log is organised by month. When you enter this screen you will be prompted to enter the month for which you wish to view events.

Instrument This field allows the instrument to be set to either **Online** (normal instrument operation) or **In Maintenance** (data is flagged as invalid).

Safely Remove USB Stick	Always select this menu item before removing the USB memory stick or select the same menu item from the Service Menu (refer to Section 3.4.12). Failure to do this may cause corruption of the memory stick.
Instrument Gain	This is a multiplication factor which is used to adjust the concentration measurement to the appropriate level (set by performing a Span Calibrate NOx). This should be recorded after each calibration in the station log book.
Next Service Due	A field that notifies the user when the next instrument service is due. This value is editable in the Next Service Due field of the Advanced Menu (refer to Section 3.4.29). This field is only displayed in the two weeks prior to the date displayed in this field or after the date has occurred.

3.4.2 Main Menu

There are six menus on the **Main Menu** screen.

Analyser State Menu	Refer to Section 3.4.3.
General Settings Menu	Refer to Section 3.4.8.
Measurement Settings Menu	Refer to Section 3.4.9.
Calibration Menu	Refer to Section 3.4.10.
Service Menu	Refer to Section 3.4.12.
Communications Menu	Refer to Section 3.4.20.

3.4.3 Analyser State Menu

Main Menu → Analyser State Menu

This displays the status of various parameters that affect instrument measurements.

Status Menu	Refer to Section 3.4.4.
Temperature Menu	Refer to Section 3.4.5.
Pressure & Flow Menu	Refer to Section 3.4.6.
Voltage Menu	Refer to Section 3.4.7.
Model	This field will always display Serinus.
Variant	The variant of the Serinus model. (e.g. S44)
Range	The range of the Serinus model (Standard, High or Trace).
Ecotech ID	The Ecotech ID number.
Serial No.	The main controller PCA serial number.
Board Revision	The main controller PCA version.
Firmware Ver.	This field displays the firmware version currently in use on this instrument. This can be important when performing diagnostics and reporting back to the manufacturer.
Power Failure	This field displays the time and date of the last power failure or when

power was disconnected from the instrument.

3.4.4 Status Menu

Main Menu → Analyser State Menu → Status Menu

The **Status Menu** presents a list of the current **Pass/Fail** statuses of the main components. During warm-up, the status of some parameters will be a dashed line.

Event Log	This field enters a screen with a log of all the events that the instrument has performed. These events include errors and warnings. This log is stored on the USB memory stick. The log is organised by month. When you enter this screen you will be prompted to enter the month for which you wish to view events.
Show Error List	This field allows the user to display the list of current errors and warnings on the screen.
Next Service Due	This field is visible with the next service due date if the service is due within the next two weeks.
+5V Supply	Pass if the +5V power supply is within the acceptable range.
+12V Supply	Pass if the +12V power supply is within the acceptable range.
+Analog Supply	Pass if the analog power supply is within the acceptable range (+12V).
-Analog Supply	Pass if the analog power supply is within the acceptable range (-12V).
A2D	Fail only if a problem is detected with the analog to digital conversion.
Cell Temp.	Pass if the cell heater temperature is within $\pm 10\%$ of the heater set point (refer to Section 3.4.5).
Converter Temp.	The converter temperature should be 325°C. It must be between 250°C and 350°C to pass.
Cooler	Status of the PMT cooler. It must be 13°C $\pm 10\%$ to pass.
High Voltage	Fail if the high voltage value is <20 or >30 from the target. Target is 650V (Standard), 700 (Trace) and 550(High).
System Power	Pass if the system has an adequate electrical supply.
Maintenance Mode	Error if the system is “ In Maintenance ” (refer to Section 3.4.12).
Diagnostic Mode	Error if the electronics are in Diagnostic Mode (refer to Section 3.4.14).
Diagnostic PTF Comp	Error if the Pres/Temp/Flow Comp. is disabled (refer to Section 3.4.13).
Diagnostic Control	Error if the control loop is disabled (refer to Section 3.4.13).
Valve Manual Control	Error if the valve sequencing is disabled (refer to Section 3.4.15).
Ozonator	Indicates if the Ozonator is on or off.
NO Conc V Saturated	Indicates if the voltage of the concentration during measurement is within the limits of the analog to digital converter (-0.26 to 3.29V).
NOx Conc V Saturated	Indicates if the voltage of the concentration during measurement is within the limits of the analog to digital converter (-0.26 to 3.29V).
Nx Conc V Saturated	Indicates if the voltage of the concentration during measurement is within the limits of the analog to digital converter (-0.26 to 3.29V).

Bkgnd Conc V Saturated	Indicates if the voltage of the concentration during background measurement is within the limits of the analog to digital converter (-0.26 to 3.29V).
Flow Fault	Ok when the instrument has acceptable sample flow based on the difference between cell and ambient pressures.
Valve Man. Temp.	Pass if the valve manifold temperature is within $\pm 10\%$ of the heater set point.
Chassis Temp.	Pass if the chassis temperature is within the acceptable limits (0-50°C).
USB Stick Disconnected	Detects whether a USB memory stick is plugged into the front USB port.
Instrument Warmup	Ok once the instrument is out of warm-up status.

3.4.5 Temperature Menu

Main Menu → Analyser State Menu → Temperature Menu

Temperature Units	The current temperature units of the instrument (Celsius, Fahrenheit or Kelvin).
Set Point (CELL/MANIFOLD)	The temperature set point of the measurement cell and manifold. The factory default is 50°C.
Cell	Displays current temperature of the reaction cell.
Converter	Temperature of the NO ₂ to NO converter. This line will display Converter sensor absent if the converter is not operating or not plugged in.
Chassis	Displays the temperature of air inside the chassis, measured on the main controller PCA board.
Cooler	Temperature of the PMT cold block.
Manifold	Displays the current temperature of the auxiliary valve manifold.

3.4.6 Pressure & Flow Menu

Main Menu → Analyser State Menu → Pressure & Flow Menu

Pressure Units	Select the units that the pressure will be displayed in (torr, PSI, mBar, ATM or kPa).
Ambient	Current ambient pressure.
Cell	Current pressure within the reaction cell.
Manifold	Current pressure in the auxiliary valve manifold.
Sample Flow	Indicates the gas flow through the sample port of the instrument. The value should be ~0.92 slpm. If there is an error with the sample flow, it will read 0.00 slpm.

3.4.7 Voltage Menu

Main Menu → Analyser State Menu → Voltage Menu

High Voltage	The voltage applied to the PMT (normally set to 650 volts \pm 15V for ambient applications).
Conc Voltage (RAW)	Voltage from the sensor proportional to the detected signal from the reaction cell. This voltage represents the actual measurement of gas.
Conc Voltage	Displays the detector voltage after PGA scaling.
+5V Supply	+5V power supply.
+12V Supply	+12V power supply.
+Analog Supply	+12V (primary) power supply. The value should be within \pm 2V.
-Analog Supply	-12V (primary) power supply. The value should be within \pm 2V.

3.4.8 General Settings Menu

Main Menu → General Settings Menu

Decimal Places	Select the number of decimal places (0-5) used for the concentration displayed on the home screen.
Conc. Units	Sets the concentration units (ppm , ppb , ppt , mg/m3 , μg/m3 or ng/m3).
Conversion Factor [gravimetric units]	This option only appears if concentration units are set to gravimetric (mg/m3 , μg/m3 or ng/m3). Select either 0°C , 20°C or 25°C . This sets the standard temperature used from conversion for measured volumetric values.
Temperature Units	Select the units that temperature will be displayed in (Celsius , Fahrenheit or Kelvin).
Pressure Units	Select the units that the pressure will be displayed in (torr , PSI , mBar , ATM or kPa).
Date	Displays the current date and allows users to edit if required.
Time	Displays the current time and allows users to edit if required.
Backlight	Select the length of time the screen and keypad backlight remain on after a button press. The setting Always Off means the backlight never turns on; the setting Always On means the backlight never turns off.
Home Screen	This field allows the user to display concentrations on the Home Screen in two formats. The first is Inst. only which displays only the instantaneous concentration reading, the second is Inst & Avg which displays both instantaneous and average concentration on the Home Screen . The average is measured over the time period set in Measurement Settings Menu (refer to Section 3.4.9).
Char 0 has Slash	When enabled, the instrument will display the zero character with a slash (0) to differentiate it from a capital 'O'.

3.4.9 Measurement Settings Menu

Main Menu → Measurement Settings Menu

Average Period	Set the time period over which the average will be calculated: Minutes (1, 3, 5, 10, 15 or 30) or hours (1, 4, 8, 12 or 24).
Filter Type	Sets the type of digital filter used (None, Kalman, 10 sec, 30 sec, 60 sec, 90 sec, 300 sec or Rolling). The Kalman filter is the factory default setting. The Kalman filter gives the best overall performance for this instrument.
Rolling Size [Rolling filter]	Sets the number of measurements included in the rolling average. Only available if the Filter Type is set to Rolling .
NO2 Filter	When enabled this function will apply a low pass digital filter to NO ₂ measurement removing any artificial signal resulting from pneumatic differences between NO and NO _x gas lines.
Noise	The standard deviation of the concentration. The calculation is as follows: <ul style="list-style-type: none"> ▪ Take a concentration value once every two minutes. ▪ Store 25 of these samples in a first in, last out buffer. ▪ Every two minutes, calculate the standard deviation of the current 25 samples. <p>This reading is only valid if zero air or a steady concentration of span gas has been supplied to the instrument for at least one hour. An invalid reading will be displayed as #####.</p>

3.4.10 Calibration Menu

Main Menu → Calibration Menu

Calibrating the instrument should be done with care (refer to Section 5 before using these menus).

Cal. Type	Depending on the selection in this field, a number of extra menu items will be displayed. These are separately documented in Manual Mode (refer to Section 3.4.10.1) and Timed Mode (refer to Section 3.4.10.2). Select the Cal. Type field and select either Timed or Manual . Timed mode is an automatic calibration controlled by the: <ul style="list-style-type: none"> ▪ Interval between cycles ▪ Length of each calibration cycle ▪ Time when the calibration will begin ▪ Check only or automatic compensation Manual mode allows the user to choose the type of calibration they wish to perform and will open the appropriate valves in preparation for the user to perform a manual calibration. The setup used will depend on the Cal. Mode selected. Manual mode is set as default.
Zero Source	Select whether the instrument will sample from the external calibration

	port or from the internal zero source when zero gas is requested.
Cycle Time	The duration of each Cal. Mode (span and zero) when performing Cycle Mode (refer to Section 3.4.10.1) or Cal. Type is set to Timed (refer to Section 3.4.10.2).
Span Calibrate NOx	This field is used to perform a span calibration and should be only used when a known concentration of span gas is running through the reaction cell and the reading is stable. Activating the span calibrate field for a named gas will open a dialog box. Enter the concentration of the span gas that the instrument is sampling and press Accept .
Zero Calibrate NO	This command is used to correct the zero calibration setting. This option should be used only when zero gas is running through the reaction cell (refer to Section 5.3 before using this command).
Zero Calibrate NO2	This command is used to correct the zero calibration setting. This option should be used only when zero gas is running through the reaction cell (refer to Section 5.3 before using this command).
Zero Calibrate NH3	This command is used to correct the zero calibration setting. This option should be used only when zero gas is running through the reaction cell (refer to Section 5.3 before using this command).
Pressure Calibration Menu	This menu allows the user to calibrate the pressure sensors (refer to Section 3.4.11).
Pressure NO	This field displays the auxiliary valve manifold pressure measured during the last calibration for the NO path.
Pressure NOx	This field displays the auxiliary valve manifold pressure measured during the last calibration for the NO _x path.
Pressure Nx	This field displays the auxiliary valve manifold pressure measured during the last calibration for the N _x path.
Temperature	Cell temperature when the last span calibration was performed.
Conv. Efficiency NO2	The overall efficiency of the conversion of NO ₂ to NO, in the first internal NO ₂ to NO converter.
Conv. Efficiency NH3	The overall efficiency of the conversion of NH ₃ to NO. Taking into account the combined efficiency of both the External NH ₃ converter and the second internal NO ₂ to NO converter.

3.4.10.1 Manual Mode

These items appear in the **Calibration Menu** when **Calibration Type** is set to **Manual**.

Cal. Mode	<p>When calibration type is set to Manual the instruments operational mode can be chosen from the following:</p> <ul style="list-style-type: none"> ▪ Measure: Is the normal measurement through the sample port. ▪ Zero: This mode will take air through the calibration port so that a zero calibration can be performed. Data is flagged as zero data. ▪ Span: This mode will take air through the calibration port so that a span calibration can be performed. Data is flagged as span data. ▪ Cycle: Performs a zero and a span Cal. Mode and then returns to measure mode. The length of time spent measuring each calibration
------------------	---

mode is set in **Cycle Time** (refer to Section 3.4.10).
 While the instrument is still in the warm-up period (refer to Section 3.1) the **Cal. Mode** cannot be changed from **Measure** mode.

3.4.10.2 Timed Mode

These items appear in the **Calibration Menu** when **Calibration Type** is set to **Timed**.

Date	Enter the date for the next calibration to start.
Time	Enter the time that calibration will be performed. The time is set using a 24 hour clock.
Repeat	This field indicates the delay period; once the specified amount of time has lapsed the calibration will automatically run again. The user can edit this field (from 1 to 20,000 units).
Units	This is where the user can define the type of units for the Repeat delay period. For example: A repeat of “3” and units of “Days” means that a calibration will automatically be performed every three days.
Span Compensation	When Enabled the instrument will automatically perform a Span Calibrate NOx at the end of the Cycle Time and adjust the gain based on the Span Level . When Disabled it will do a precision check only, no adjustment is made.
Span Level	Enter the concentration of span gas expected. Used when the Span Compensation is Enabled .

3.4.11 Pressure Calibration Menu

Main Menu → Calibration Menu → Pressure Calibration Menu

Entering this menu will set the valves to the pressure calibration configuration and will disable the ozone generator; leaving the menu will restore the valves to normal operation and enable the ozone generator (refer to Section 5.2).

Vacuum Set Pt.	The zero point for the calibration. Activating this item will open a dialog box of instructions.
Ambient Set Pt.	The high point for the calibration. Activating this item will open a dialog box of instructions.
Pressure Units	Select the units that the pressure will be displayed in (torr, PSI, mBar, ATM or kPa).
Ambient	The current ambient pressure.
	The current ambient pressure displayed as a raw voltage.
Cell	The current pressure in the reaction cell.
	The current reaction cell pressure displayed as a raw voltage.
Manifold	The current pressure in the auxiliary valve manifold.
	The current auxiliary valve manifold pressure displayed as a raw voltage.

3.4.12 Service Menu

Main Menu → Service Menu

Diagnostics Menu	Refer to Section 3.4.13.
Calculation Factors Menu	Refer to Section 3.4.19.
Ozone Gen. Control	Allows the user to switch off the ozone generator or let the instrument automatically control the status of the ozone generator. For safety reasons, the ozone generator will not be active if there is a flow fault.
Ozone Gen. Status	This field indicates to the user if the Ozone generator is On or Off .
Load Auto-Backup Config.	Loads the auto-backup configuration file. The configuration is automatically backed up every night at midnight.
Load Configuration	Loads a user selectable configuration file from the USB memory stick.
Save Configuration	Saves all of the EEPROM-stored user-selectable instrument configurations to the USB memory stick (calibration and communication settings, units, instrument gain, etc). If there are problems with the instrument use this function to save settings to the USB memory stick and send this file (together with the parameter list save) to your supplier with your service enquiry.
Save Parameter List	Saves a text file of various parameters and calculation factors. If you have problems with the instrument use this function to save settings to the USB memory stick and send this file (together with the configuration save) to your supplier with your service enquiry.
Instrument	This field allows the instrument to be set to either Online (normal instrument operation) or In Maintenance (data is flagged as invalid).
Next Service Due	Displays when the next scheduled service is due.
Safely Remove USB Stick	This command must be activated to safely remove the USB memory stick.
System Restart	Activating this will restart the instrument.

3.4.13 Diagnostics Menu

Main Menu → Service Menu → Diagnostics Menu

Digital Pots Menu	Refer to Section 3.4.14.
Valve Menu	Refer to Section 3.4.15.
Tests Menu	Refer to Section 3.4.16.
Pres/Temp/Flow Comp.	<p>On (default): Is used to compensate instrument measurements for environmental fluctuations that might affect readings (pressure, temperature and flow).</p> <p>Off: Is used only when running diagnostics.</p>
Control Loop	<p>Enabled (default): Allows the instrument to automatically adjust digital pots and other outputs.</p> <p>Disabled: Prevents the instrument from changing most outputs so the service technician can manually control them.</p>

3.4.14 Digital Pots Menu

Main Menu → Service Menu → Diagnostics Menu → Digital Pots Menu

Digital pots are electronically controlled digital potentiometers used for adjustments to operations of the instrument. Each of the digital pots can go from 0-255. This menu should be accessed only during diagnostics.

Unless the **Control Loop** is **Disabled** (refer to Section 3.4.13), changes to the pots may be modified by the instrument. This is intentional; some diagnostics are best done with instrument feedback and some are best done without.

High Volt Tuning	Disabled	When the instrument first starts it will tune the high voltage supply by automatically setting the High Volt Adj Pot . After a stable value is reached the instrument will Disable the High Volt Tuning . You can force the instrument to re-tune the high voltage supply by setting this field to Enabled and rebooting the instrument.
High Volt Adj Pot	130-150	Allows manual adjustment of the PMT high voltage supply.
High Voltage	640-670	The voltage applied to the PMT.
PGA Gain	1-128	Displays the gain of the PGA.
Input Pot	104	Reduces the raw signal to measurable level.
Conc Voltage (RAW)	0-3.1	The concentration voltage measured by the analog to digital converter.
Conc Voltage	0-3.1	The concentration voltage after adjustment for the PGA gain factor.
Diagnostic Mode	Operate	<ul style="list-style-type: none"> ▪ Operate (default): Puts the instrument in normal operation mode. ▪ Electrical: Injects an artificial test signal into the electronic processing circuitry on the main controller PCA to verify that the circuitry is operating correctly. When in this Diagnostic Mode, adjust the Diagnostic Test Pot from 0 to 255. This will produce a change in the concentration voltage as well as the indicated gas concentration. ▪ Preamp: Injects an artificial test signal into the Preamplifier module mounted in the optical bench to verify that the Preamplifier, cabling and electronic circuitry on the main controller PCA is operating correctly. When in this Diagnostic Mode, adjust the Diagnostic Test Pot from 0 to 255. This will produce a change in the concentration voltage as well as the indicated gas concentration. ▪ Optic [Optional]: Emits artificial light into the Reaction Cell to simulate a real chemiluminescence reaction. This will verify that the PMT, Preamp and electronic circuitry on the main controller PCA is operating correctly. When in this Diagnostic Mode, adjust the Diagnostic Test Pot from 0 to 255. This will produce a change in the concentration voltage as well as the indicated gas concentration. This menu item is only available if you have installed the optical test lamp (refer to Section 3.4.30).
Diagnostic Test Pot	0	This Digital Pot is used for diagnostics only. When in the Electrical ,

Preamp or Optic Diagnostic Mode, this Digital Pot should be adjusted from 0 to 255. This will produce a change in the concentration voltage as well as the indicated gas concentration.

3.4.15 Valve Menu

Main Menu → Service Menu → Diagnostics Menu → Valve Menu

The **Valve Menu** allows the user to observe the instrument controlled switching of the valves. If the valve is **ON** it means the valve is energised. When a three way valve is in the **ON** state it will now be in the **NC** (normally closed) position as shown in the plumbing schematic. When the valve sequencing is disabled the user has the ability to turn the valve **OFF** and **ON** manually. It is recommended that the valve menu be used by a trained technician following the plumbing schematic (refer to Section 9.5).

Note: When interpreting the information below regarding the flow path through the valve note that (**NC** = Normally Closed), (**NO** = Normally Open) and (**C** = common).

Valve Sequencing	When Enabled the valves will turn On and Off under the instruments control (even if you have manually turned Off or On a valve). When Disabled the valves will change only in response to a user's action.
Sample/Cal	Indicates if the Sample/Cal valve on the Calibration Valve Manifold is Off or On . This will determine the port the instrument draws its sample from. Off = Flow from NO to C (drawing sample from the Sample Port). On = Flow from NC to C (drawing sample from the Calibration Port).
Internal Zero/Cal	Indicates if the Internal Zero/Cal valve on the Calibration Valve Manifold is Off or On . This will determine the port the instrument draws its sample from, when selecting Cal. Mode → Zero . Off = Flow from NO to C (drawing sample from the BGnd Air Port). On = Flow from NC to C (drawing sample from the Calibration Port).
Pressurised Zero [optional]	Indicates if the optional pressurised zero port valve is Off or On (refer to Section 8.2).
Pressurised Span [optional]	Indicates if the optional pressurised span port valve is Off or On (refer to Section 8.2).
NO Select	Indicates if the NO Select valve on the Auxiliary Valve Manifold is Off or On . This valve switches the sample either straight through the NO flow path to the reaction cell or bypasses out the Exhaust Port . Off = Flow from C to NO (NO flow path bypassed to Exhaust Port). On = Flow from C to NC (NO flow path to Reaction Cell).
NOx Select	Indicates if the NOx Select valve on the Auxiliary Valve Manifold is Off or On . This valve switches the sample either straight through the NOx

	<p>flow path to the reaction cell or bypasses out the Exhaust Port. On = Flow from C to NC (NOx flow path to Reaction Cell). Off = Flow from C to NO (NOx flow path bypassed to Exhaust Port).</p>
Nx Select	<p>Indicates if the Nx Select valve on the Auxiliary Valve Manifold is Off or On. This valve switches the sample either straight through the Nx flow path to the reaction cell or bypasses out the Exhaust Port. On = Flow from C to NC (Nx flow path to Reaction Cell). Off = Flow from C to NO (Nx flow path bypassed to Exhaust Port).</p>
Measure/Background	<p>Indicates if the Measure/Background valve on the Auxiliary Valve Manifold is Off or On. This valve determines whether the sample is pre-reacted with ozone before arriving at the reaction cell. This creates no reaction in the reaction cell and enables a 'Background' measurement to be taken. On = Flow from C to NC (NO flow path to Pre-Reaction). Off = Flow from C to NO (NO, NOx and Nx flow path to Reaction Cell).</p>

3.4.16 Tests Menu

Main Menu → Service Menu → Diagnostics Menu → Tests Menu

Screen Test	<p>Performs a screen test by drawing lines and images on the screen so that the operator can determine if there are any faults in the screen. Press a keypad key to step through the test. The up and down arrow keys will adjust the contrast.</p>
Digital Input Test Menu	Refer to Section 3.4.17.
Digital Output Test Menu	Refer to Section 3.4.18.

3.4.17 Digital Input Test Menu

Main Menu → Service Menu → Diagnostics Menu → Tests Menu → Digital Input Test Menu

Input 0..7	Displays the status of the 0-7 digital input pins. Value will be 0 or 1.
-------------------	--

Note: Entering either the **Digital Inputs Menu** will temporarily disable all digital and analog input/outputs. This will affect logging via these outputs. Exiting the menu restores automatic control.

3.4.18 Digital Output Test Menu

Main Menu → Service Menu → Diagnostics Menu → Tests Menu → Digital Output Test Menu

Automated Test	When started will automatically step through each output, turning it On and Off.
Output 0..7	Displays the state of the output pin (On or Off) and allows the user to manually set the state.

Note: Entering either the **Digital Outputs Menu** will temporarily disable all digital and analog input/outputs. This will affect logging via these outputs. Exiting the menu restores automatic control.

3.4.19 Calculation Factors Menu

Main Menu → Service Menu → Calculation Factors Menu

The **calculation** factors provide the values used to calculate different aspects of measurement and calibration.

Dilution Ratio	<p>Entering a value here will multiply the displayed and recorded measurements by the dilution amount. For example, if the instrument is measuring a source where the average concentration is above the upper limit of the measurement range, a dilution probe with a fixed ratio dilution ratio can be used to reduce the level measured by the instrument, so for a 4:1 dilution ratio, enter a value of 4.</p> <p>Enter the ratio here so the analyser can display the correct value on the instrument.</p> <p>The default value is 1.00 (this indicates no dilution is applied).</p>
Instrument Gain	<p>A multiplication factor used to adjust the concentration measurement to the appropriate level (set at calibration).</p>
Zero Offset NO	<p>This field displays the offset created from a NO zero calibration. This is the concentration measured from zero air and is subtracted from all readings.</p>
Zero Offset NO₂	<p>This field displays the offset created from a NO₂ zero calibration. This is the concentration measured from zero air and is subtracted from all readings.</p>
Zero Offset NH₃	<p>This field displays the offset created from a NH₃ zero calibration. This is the concentration measured from zero air and is subtracted from all readings.</p>
Background NO	<p>The correction factor calculated from the background cycle (used to eliminate background interferences).</p>
PTF Correction NO	<p>Displays the correction factor applied to the concentration measurement. This correction is for changes in pressure, temperature and flows since the last calibration.</p>
PTF Correction NO_x	<p>Displays the correction factor applied to the concentration measurement. This correction is for changes in pressure, temperature and flows since the last calibration.</p>
PTF Correction N_x	<p>Displays the correction factor applied to the concentration measurement. This correction is for changes in pressure, temperature and flows since the last calibration.</p>
Conv. Efficiency NO₂	<p>The overall efficiency of the conversion of NO₂ to NO, in the first internal NO₂ to NO converter.</p>
Conv. Efficiency NH₃	<p>The overall efficiency of the conversion of NH₃ to NO, in the External converter, combined with the efficiency of the second internal NO₂ to NO converter.</p>
Noise	<p>The standard deviation of the concentration. The calculation is as follows:</p> <ul style="list-style-type: none"> ▪ Take a concentration value once every two minutes. ▪ Store 25 of these samples in a first in, last out buffer. ▪ Every two minutes, calculate the standard deviation of the current

25 samples. This is a microprocessor-generated field and cannot be set by the user.

This reading is only valid if zero air or a steady concentration of span gas has been supplied to the instrument for at least one hour.

3.4.20 Communications Menu

Main Menu → Communications Menu

Configures how the instrument communicates with external instrumentation and data loggers.

Data Logging Menu	Refer to Section 3.4.21.
Serial Communication Menu	Refer to Section 3.4.22.
Analog Input Menu	Refer to Section 3.4.23.
Analog Output Menu	Refer to Section 3.4.24.
Digital Input Menu	Refer to Section 3.4.25.
Digital Output Menu	Refer to Section 3.4.26.
Network Menu	Refer to Section 3.4.27.
Bluetooth Menu	Refer to Section 3.4.28.

3.4.21 Data Logging Menu

Main Menu → Communications Menu → Data Logging Menu

When editing the numeric or text menus, the “-” key will delete the current parameter and move the others up to take its place; the “+” key will insert a parameter at the current location and move the ones below it down. The internal logger can log a maximum of 12 parameters.

Data Log Interval	Displays the interval at which the data is saved to the USB memory stick. Selecting a 1 sec interval may result in occasional measurements not being logged or slow response to serial commands.
Data Log Setup – Numeric	Numeric list of the parameters logged. This is a quicker way to enter parameters (for lists of parameters refer to Table 12).
Data Log Setup – Text	Select the list of logged parameters by name.

3.4.22 Serial Communication Menu

Main Menu → Communications Menu → Serial Communication Menu

Serial ID	This is the ID of the instrument when using multidrop RS232 communications. This ID can be changed to support multiple instruments on the same RS232 cable.
Bayern-Hessen 2 nd ID [Bayern-Hessen protocol]	This is the ID of the second gas when using the Bayern-Hessen protocol. The ID of the first gas is always the Serial ID .
Bayern-Hessen 2 nd Gas	Controls which gas is exported as the second gas, either NO_x or NO₂ .

[Bayern-Hessen protocol]

Service port (RS232 #1) The port parameters below are repeated for each serial port.
Multidrop port (RS232 #2)

Serial Delay Some older communication systems require a delay before the instrument responds to a serial command. The number of milliseconds of delay required (0-1000). The default is 0, meaning the instrument responds as quickly as possible to any serial request.

Baudrate Sets the baud rate for this serial port (**1200, 2400, 4800, 9600, 14400, 19200, 38400** or **115200**).

Protocol Sets the protocol used for this serial port (**Advanced, ModBus, EC9800** or **Bayern-Hessen**). This must be set to **Advanced** for Ecotech supplied software.

Endian Select **Little** or **Big** endian mode for ModBus protocol.

[Modbus protocol]

3.4.23 Analog Input Menu

Main Menu → Communications Menu → Analog Input Menu

The Serinus supports three analog inputs from the 25 pin I/O connector. Each input is a 0 to 5 volt CAT 1 input that can be scaled and logged to the USB memory stick or accessed remotely as parameters 199 to 201.



CAUTION
Exceeding these voltages can permanently damage the instrument and void the warranty.

Input 1/2/3 The sections below are repeated for each analog input.

Multiplier The input voltage will be multiplied by this number. For example, if a sensor has a 0-5V output for a temperature of -40°C to 60°C, the multiplier would be $(60 - (-40)) / 5 = 20$.

Offset This value will be added to the above calculation. Continuing the example in the multiplier description, the offset should be set to -40, so that a voltage of 0V will be recorded as -40°C.

Reading The current reading from the input voltage, after the multiplier and offset has been applied. This is the value that is logged or reported as parameter 199 to 201 via USB or serial requests.

3.4.24 Analog Output Menu

Main Menu → Communications Menu → Analog Output Menu

Output Mode	The analog output can be set to be either Current or Voltage . Different fields will be displayed depending on which analog output type is selected.
NO NH3 NO2	The name of the gas for each analog output. All of the fields below are repeated for each gas.
Min Range	Sets the lower range limit (in concentration units). This is the value at which the analog output should be at its minimum. For example, 4mA for a 4 to 20mA current output.
Max Range	Set the upper range limit (in concentration units). This value can be edited but cannot exceed the Over Range value. This is the value at which the analog output should be at its maximum. For example, 20mA for a current output.
Over-Ranging	Set to Enabled or Disabled to turn the over-ranging feature on or off.
Over-Range	This field is only visible when Over-Ranging is set to Enabled . Set to the desired over range value. This value cannot be set below the Max Range value. This is the alternate scale that is used for the analog output when over-ranging is active and enabled. When 90% of the standard range is reached, this over range is automatically entered. When 80% of the original range is reached, it returns to the original range.

3.4.24.1 Analog Output Menu - Voltage

Main Menu → Communications Menu → Analog Output Menu

These items appear when **Output Mode** is set to **Voltage**.

Voltage Offset	Choices are 0V , 0.25V or 0.5V . This sets the voltage for a reading of 0. Since the output cannot go negative, this offset can be used to record negative readings.
0.5V Calibration	Enables the user to calibrate the analog voltage output at a low point. Increase/decrease the value until the connected equipment reads 0.5V (refer to Section 3.4.24.1).
5.0V Calibration	Enables the user to calibrate the analog voltage output at a full scale point (5V). Increase/decrease the value until the connected equipment reads 5V (refer to Section 3.4.24.1).

3.4.24.2 Analog Output Menu - Current

Main Menu → Communications Menu → Analog Output Menu

These items appear when **Output Mode** is set to **Current**.

Current Range	Enables the user to set desired current ranges. The user's choices are 0-20mA , 2-20mA or 4-20mA .
4mA Calibration	Enables the user to calibrate the current output at a low point. Increase/decrease the value until the connected equipment reads 4mA (refer to Section 4.4.1.2).
20mA Calibration	Enables the user to calibrate the current output at a full scale point (20mA). Increase/decrease the value until the connected equipment reads 20mA (refer to Section 4.4.1.2).

3.4.25 Digital Input Menu

Main Menu → Communications Menu → Digital Input Menu

This menu is used to remotely trigger zero and span calibrations. This is done by assigning the eight digital inputs with one of the following commands.

DI N (Pin X)	<p>Associates an action with a digital input. There are eight digital inputs (the pin numbers are for the 25 pin connector). Each one can have one of the following associated actions, triggered when the corresponding digital input goes to the Active state:</p> <ul style="list-style-type: none"> ▪ Disabled: No action (this digital input does nothing). ▪ Do Span: Used to perform a span precision check. When activated the instrument sets the Cal. Mode to Span (refer to Section 3.4.10.1). ▪ Do Zero: Used to perform a zero precision check. When activated the instrument sets the Cal. Mode to Zero (refer to Section 3.4.10.1).
Active	Each pin can be set to be active High or Low . Active High means that the event will be triggered when the line is pulled to 5V. Active Low means that the event will be triggered when the line is pulled to 0V.

Example

Here is a typical configuration between an instrument and either a data logger or calibrator (master device):

1. Set the jumper JP1 to 5V position (refer to Section 4.4.3).
2. Connect one of the master devices digital output signals to pin 18 and the ground signal to pin 5 of the instrument's analog/digital 25 pin female connector (refer to Figure 20).
3. Program master device to output 0 volts to pin 18 when a span is desired.
4. In the instrument's **Digital Input Menu** assign **DI 0 Do Span**.

- The same procedure can be followed to also activate zero calibrations. Pin 6 of the instrument’s analog/digital 25 pin female connector can be connected to one of the other master devices digital outputs and the instrument can be set so **DI 1** is assigned to **Do Zero**.

3.4.26 Digital Output Menu

Main Menu → Communications Menu → Digital Output Menu

This allows the instrument to trigger external alarms in response to certain events.

There are eight different pins available, which will be set high during an associated event:

DO N (Pin X)	Associates a state with a digital output. There are eight digital outputs (the pin numbers are for the 25 pin connector). Each one can have one of the associated states listed in Table 3 – Digital Output States. The pin will be driven to the active state while the instrument state is true.
Active	Each pin can be set to be active High or Low . Active High means that the pin will be pulled to 5V when the associated event occurs. Active Low means the pin will be pulled to 0V when the associated event occurs.

Table 3 – Digital Output States

Digital Output State	Description
Disabled	No state (this state is never Active).
High Volt. Fail	High voltage fault.
Pwr Supply Fail	Power supply fault.
Ref Volt. Fail	Reference voltage fault.
A2D Fail	Analog to digital fault.
Lamp Fail	Lamp fault.
Flow Fail	Sample flow fault.
Cell Heat Fail	Cell heater fault.
Conv. Heat Fail	Converter heater fault.
Manfld Heat Fail	Manifold heater fault.
Lamp Heat Fail	Lamp heater fault.
Chassis Tmp Fail	Chassis temperature fault.
Cooler Fail	Cooler temperature fault.
USB Disconnected	The USB memory stick is disconnected.
Background	Performing a background.
Span	Performing a span check.
Zero	Performing a zero check.
System Fault	Any system fault (the red light is on).

3.4.27 Network Menu

Main Menu → Communications Menu → Network Menu

The **Network Menu** only appears when the **Network Port** is enabled in the **Hardware Menu** (refer to Section 3.4.30). The **Network Menu** allows the user to view or set the IP Address, Netmask and Gateway if the optional network port is installed.

Start-up Mode	<p>The following modes are available:</p> <ul style="list-style-type: none"> ▪ NORMAL: In this mode nothing is done with the network port during boot-up. It is assumed to be configured correctly or unused. ▪ READ IP: This mode interrogates the network port for its IP address. The menu will display the network address after boot-up. ▪ SET IP: The user may enter an IP address, Netmask and Gateway address (following the usual rules for formatting these addresses). At this time the instrument does not validate the correctness of these entries. When you cycle power, the instrument will first instruct the network port on its new address. It will switch to Read IP mode and read back the address it just set so the user may verify it in the menu. ▪ Set DHCP: This sets the network port into DHCP mode, allowing the network to assign the instrument an IP address.
IP Address [Read or Set mode]	This is the current IP address of the instrument.
Netmask [Read or Set mode]	This is the subnet mask of the network the instrument is connected to.
Gateway [Read or Set mode]	This is the IP address of the router to access addresses not on the same subnet.
Adaptor is in DHCP mode [DHCP mode]	In this mode the instrument will ask for its network parameters from a DHCP server on your network.
Protocol	Sets the protocol used for the network port (Advanced, ModBus, EC9800 or Bayern-Hessen). This must be set to Advanced for Ecotech supplied software.
Endian [Protocol Modbus]	Select Little or Big endian mode for ModBus protocol.

To read the IP address, perform the following steps:

1. Set the instrument to Read IP.
2. Manually cycle power off.
3. Wait three seconds.
4. Turn power on.
5. Read or set the IP address.

3.4.28 Bluetooth Menu

Main Menu → Communications Menu → Bluetooth Menu

This instrument supports Bluetooth communication through the Serinus Remote Android Application (refer to Section 4.7).

Bluetooth	This field indicates whether the instrument is remotely connected to an Android device.
Reset Bluetooth	After changing the ID or PIN, it is necessary to reboot the Bluetooth module. This is done by resetting the instrument or by using this menu item to reboot only the Bluetooth.
ID	This is the Bluetooth ID of the instrument. Use the keypad to edit this field (refer to Section 3.3.1 for instructions on entering text with the numeric keypad). The default ID setting is Serinus(Ecotech ID) . The word Serinus is always the first part of the name and cannot be edited. The second part is the Ecotech ID .
PIN	This is a passcode/pin required for the Serinus Remote Application to connect to the instrument. The default pin is 1234.

3.4.29 Advanced Menu

This menu is accessed via a different method than the other menus. From the **Home Screen** press the following keys: $(\bar{\cdot})99(\overset{+}{\text{SPACE}})$

This menu contains technical settings, diagnostics and factory hardware installations. No items in this menu should be accessed without authorisation and supervision of qualified service personnel.

Language	Select a language.
Hardware Menu	Refer to Section 3.4.30.
Service Displays	When set to On , new items appear on many different menus. These fields are for diagnostic and service personnel only. Default is Off .
Next Service Due	Enables the user to edit the next service due date.
Jump to Next State	Moves the sequence to the next state (e.g. from Fill to Measure). This command is most commonly used to force an instrument out of the warm-up sequence early.
Parameter Display Menu	Refer to Section 3.4.31.
Reset to Factory Defaults	Reset the configuration to factory defaults. This will erase all calibrations and user configuration information.
Rebuild Index	If a data log becomes corrupted it may be possible to restore it by rebuilding its index file. This command will ask you to specify a month and will rebuild the index for that month. This operation can take many minutes and it should not be interrupted. While the file is rebuilding any data logging will be suspended.



CAUTION

No items in this menu should be accessed without authorization and supervision of qualified service personnel.

3.4.30 Hardware Menu

Advanced Menu → Hardware Menu

This menu contains factory hardware installations. If you reset to factory defaults you may need to revisit this menu to re-install optional features.

Variant	Select the instrument model. Normally this only needs to be reset when the configuration is corrupted. The selections available will depend on licensing. It is not recommended to run an instrument with firmware set to an incorrect model.
Range	Select the range of the instrument. Not all instruments support all ranges. Default is Standard .
Front Panel Style	Choosing the incorrect front panel will result in the traffic lights behaving inconsistently. Default is Aluminium .
Network Port	When Enabled indicates the instrument has a network port installed. Default is Disabled .
Orifice Size	Specify the input orifice. Default is 0.96.
Optical Test Lamp	When Enabled gives access to the optical diagnostic tests. Default is Disabled .



CAUTION

No items in this menu should be accessed without authorization and supervision of qualified service personnel.

3.4.31 Parameter Display Menu

Main Menu → Advanced Menu → Parameter Display Menu

Used to display a parameter in real-time on the screen (refer to Table 12 for a full list of parameters).

Data Parameter	This is an editable field. Enter the parameter number you wish to view (refer to Table 12)
Name	Displays the name of the selected parameter.
Value	Displays the current value of the selected parameter.

This page is intentionally blank

4. Communications

The Serinus has a number of different interfaces for communication with other equipment (RS232, USB, 25 pin digital/analog input/output, TCP/IP network (optional) and Bluetooth). A demonstration version of Ecotech's Airodis software is included with the instrument, enabling basic data downloads and remote operation from a PC running MS Windows (7 or 8). The full version of Airodis is available separately and includes automated data collection, data validation and complex reporting by multiple users. Please refer to the Airodis Manual and Section 4.6 for details on setting up and communicating with the Serinus.



Figure 12 – Communication Ports

4.1 RS232 Communication

RS232 communication is a very reliable way to access data from the instrument and is recommended for use in connection to a data logger for 24/7 communication. Both RS232 ports are configured as DCE and can be connected to DTE (Data Terminal Equipment such as a data logger or computer).

Port #2 also supports a multidrop arrangement (a configuration of multiple instruments connected via the same RS232 cable where the transmit signal is only asserted by the instrument that is spoken to).

For reliable Multidrop RS232 communications please follow these guidelines:

- Verify that the Serial ID is set to a unique value which is different to the other instruments in the chain (refer to Section 3.4.22).
- All of the instruments in the multidrop chain must have the same baud rate and communication protocol settings. A maximum of 9600 baud rate is recommended.
- The Multidrop RS232 cable should be kept to less than three meters in length.
- A 12K ohm terminating resistor should be placed on the last connector of the cable (connect from pin 2 to pin 5 and from pin 3 to pin 5 – refer to Figure 19).
- The shielding of the Multidrop cable must be continuous throughout the cable.
- The shielding of the Multidrop cable must only be terminated at one end. It should be connected to the metal shell of the DB 9 way connector.

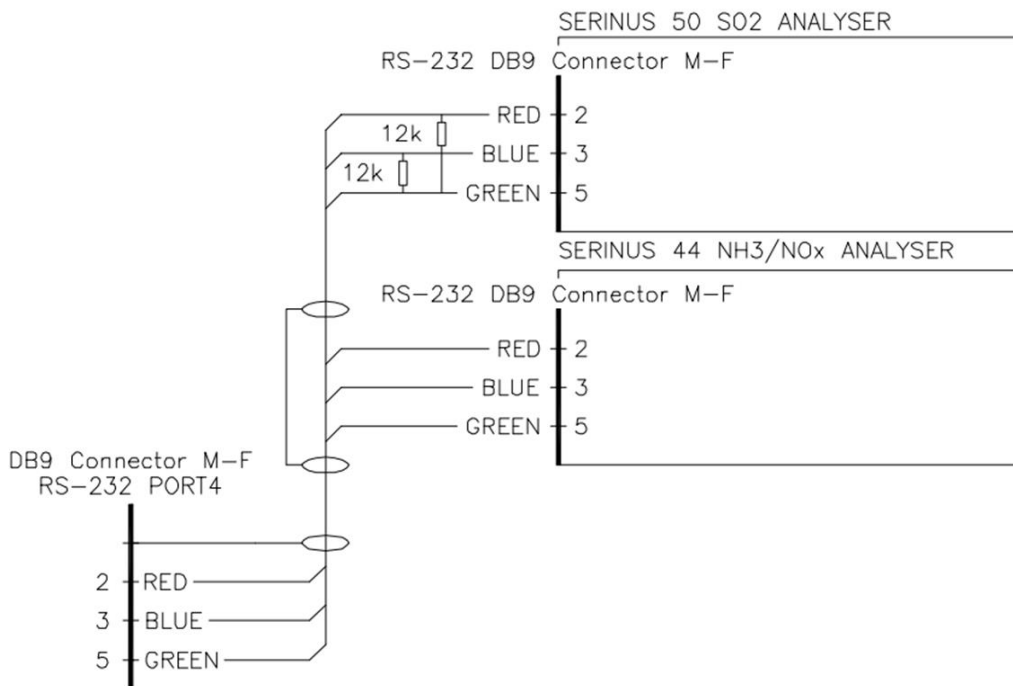

Figure 13 – Multidrop RS232 Cable Example

4.2 USB Communication

This is ideal for irregular connection to a laptop running Ecotech’s Airodis software to download logged data and remotely control the instrument. Due to the nature of USB, this is a less reliable permanent connection as external electrical noise can cause USB disconnection errors on a data logger.

For more information on making connections refer to Section 4.6.1.1.

Note: Only the Advanced protocol is supported for USB communication.

4.3 TCP/IP Network Communication (optional)

Instruments with the optional network port installed can be accessed using a TCP/IP connection. Figure 14 shows examples of some possible configurations for remote access.

Direct Connection

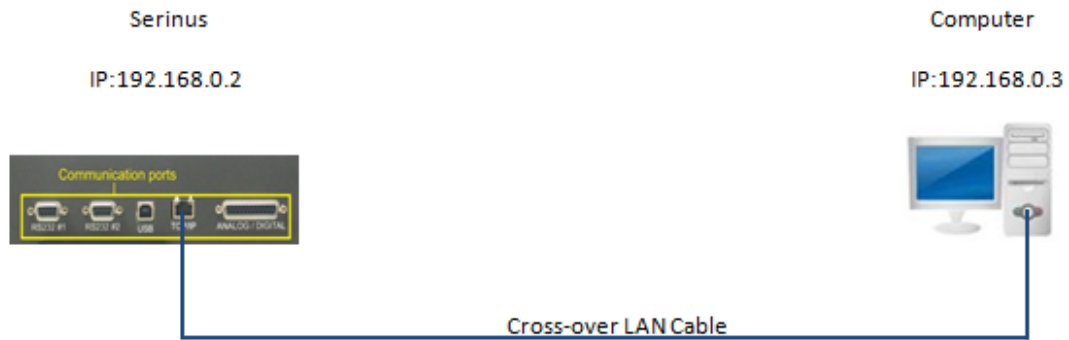

LAN

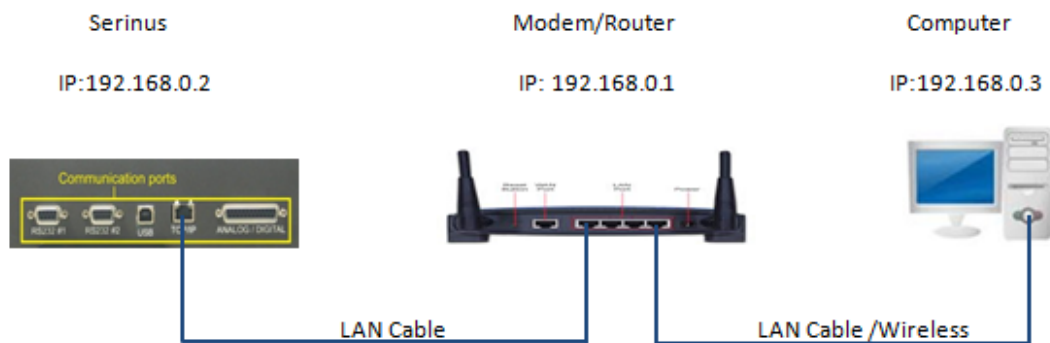

WAN

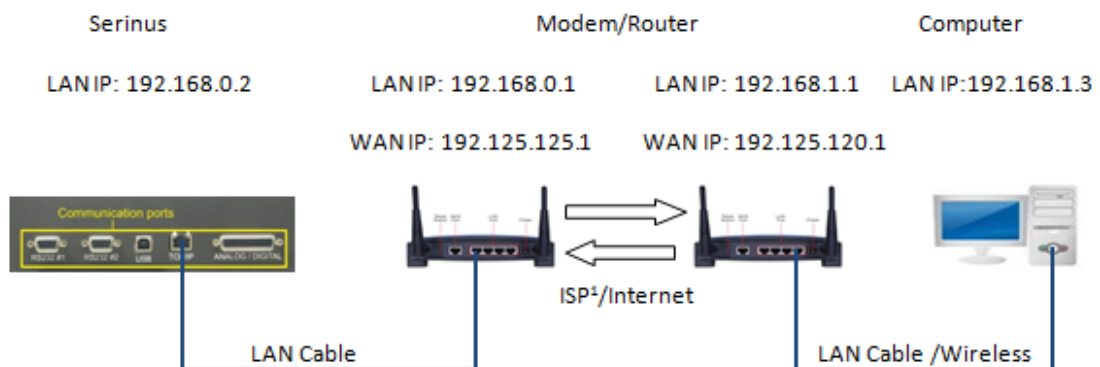

¹ ISP: Internet Service Provider

Figure 14 – Example of Typical Network Setups

Note: In Figure 14 all the IP addresses are taken as an example. The WAN IP addresses are normally provided by your ISP. Whereas, the LAN IP addresses can be set manually to any range which is within the subnet of the Modem/Router/switch.

Use a cross-over LAN cable to connect the instrument directly to a computer, or a standard LAN cable for connection to a Modem/Router/Switch as shown in Figure 14. The computer could be connected to the Modem/Router using either CAT5 cable or a wireless connection, but the instrument must be connected using CAT5/6 cable.

4.3.1 Network Setup

Below is an example of how to setup the network.

6. Open - **Main Menu** → **Communications Menu** → **Network Menu**.
7. Select - **Protocol** → **Advanced** - Accept.
8. Select - **Start-up Mode** → **Set IP** - Accept.
9. Edit - **IP Address** - (Change the IP address to the address you wish to use within the Modem/Router/switch subnet).
10. Edit - **Netmask** - (Change the Netmask to the setup specified by the Modem/Router).
11. Edit - **Gateway** - (Change the Gateway to the setup specified by the Modem/Router).

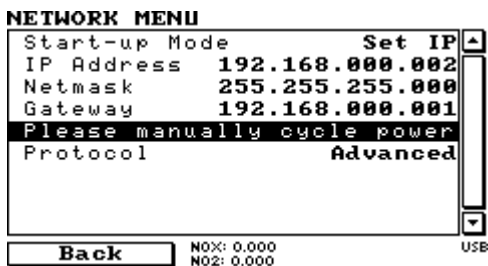

Figure 15 – Example of Network Menu Setup

12. Once completed, use the power switch on the rear of the instrument to turn the power Off. Please leave the instrument off for 10 seconds before turning the power back ON.

Note: Manually perform a hardware power cycle every time the IP address is changed for it to take affect.

4.3.2 Port Forwarding on Remote Modem/Router Setup

When using the network port to connect to the router / modem with NAT enabled, you will need to add IP mapping to ensure that data is forwarded through to the desired port. This is known as port forwarding. To set-up the port for the instrument, you will need to go into the modem/router configuration. Normally, you will see the port forwarding setup under Port Forwarding, NAT or Port Mapping menu. Below is an example port forwarding setup.

The default port for the Serinus range of instruments is 32783. The destination address is the instrument IP address setup in the **Network Menu**.

Item	Protocol	Incoming Address	Incoming Port	Destination Address	Destination Port
1	tcp	0.0.0.0	32783 - 32783	192.168.0.2	32783 - 32783

Figure 16 – Port Forwarding Example

4.3.3 Setup Airodis to Communicate with Serinus

LAN

Below is an example of Airodis setup for a LAN network. Ensure the IP address is set to the same as on the instrument **Network Menu**.

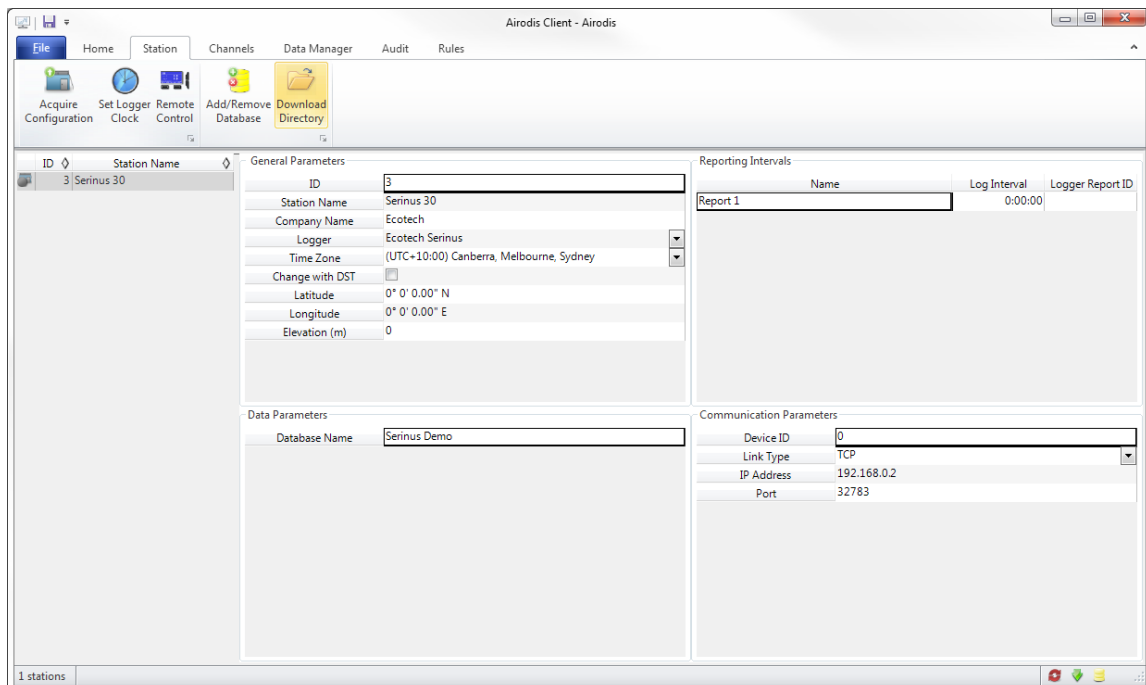

Figure 17 – LAN Network Set-Up (Airodis)

Below is an example of Airodis setup for a WAN network. Ensure the IP address is set the same as on the remote modem/router.

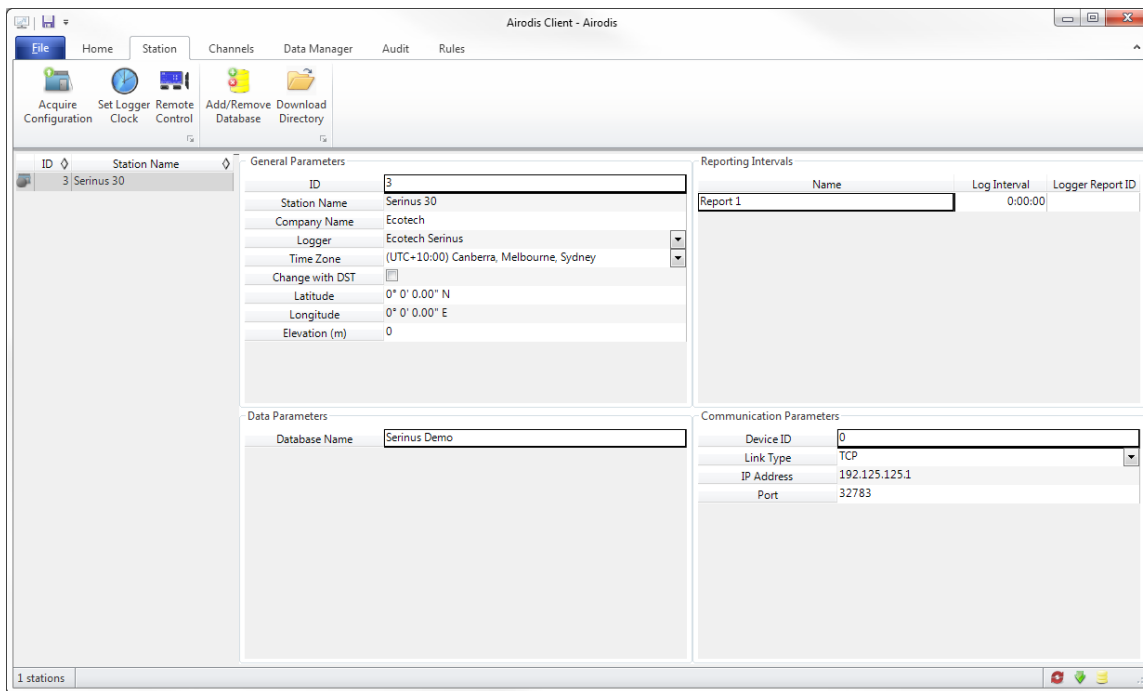

Figure 18 – WAN Network Set-Up (Airodis)

4.4 Digital/Analog Communication

The 25 Pin analog/digital port on the rear of the instrument sends and receives analog/digital signals to other devices. These signals are commonly used to activate gas calibrators or for warning alarms.

4.4.1 Analog Outputs

The instrument is equipped with one to three analog outputs that can be set to provide either voltage (0-5V, 0.25-5V, 0.5-5V, 0-10V) or current (0-20, 2-20, 4-20mA). The analog outputs are tied to specific instrument measurements, depending on the instrument type.

For 0-10V analog output operation, set the output type to current and move the jumpers (JP3) on the rear panel PCA to 0-10V (refer to Figure 14).

Table 4 – Analog Outputs

Analyser	Output 1	Output 2	Output 3
S10	O ₃	N/A	N/A
S30	CO	CO ₂ [optional]	N/A
S40	NO	NO _x	NO ₂
S44	NO	NH ₃	NO ₂
S50	SO ₂	N/A	N/A

Analyser	Output 1	Output 2	Output 3
S51	SO ₂	H ₂ S	N/A
S55	H ₂ S	N/A	N/A
S56	TS	N/A	N/A
S57	TRS	N/A	N/A
Serinus Cal 3000	N/A	O ₃	N/A

4.4.1.1 Analog Outputs Voltage Calibration

Equipment Required

- Multimeter (set to volts)
- Male 25 pin connector with cable

Procedure

1. Open - **Main Menu** → **Communications Menu** → **Analog Output Menu** (refer to Section 3.4.24).
2. Select - **Output Mode** → **Voltage**.
3. Connect a multimeter (using an appropriate adaptor or probes on the multimeter) to the ground (pin 24) and the relevant output pin (pin 10).
4. Edit - **0.5V Calibration** - (until the multimeter reads 0.500 ± 0.002) - Accept.
5. Edit - **5.0V Calibration** - (until the multimeter reads 5.00 ± 0.002) - Accept.

4.4.1.2 Analog Outputs Current Calibration

Equipment Required

- Multimeter (set to mA)
- Male 25 pin connector with cable

Procedure

1. Open - **Main Menu** → **Communications Menu** → **Analog Output Menu** (refer to Section 3.4.24).
2. Select - **Output Mode** → **Current**.
3. Connect a multimeter (using an appropriate adaptor or probes on the multimeter) to the ground (pin 24) and the relevant output pin (pin 10).
4. Edit - **4mA Calibration** - (until the multimeter reads $4\text{mA} \pm 0.01$) - Accept.
5. Edit - **20mA Calibration** - (until the multimeter reads $20\text{mA} \pm 0.01$) - Accept.

4.4.2 Analog Inputs

The instrument is also equipped with three analog inputs with resolution of 15 bits plus polarity, accepting a voltage between 0-5V. These go directly to the microprocessor and should be protected to ensure static/high voltage does damage the main controller PCA (instrument warranty does not cover damage from external inputs).

4.4.3 Digital Status Inputs

The instrument is equipped with eight logic level inputs for the external control of the instrument such as Zero or Span sequences. Each input has a terminating resistor which can be either PULL UP or PULL DOWN. This is set using the jumper JP1 on the back panel PCA (refer to Figure 19).

4.4.4 Digital Status Outputs

The instrument is equipped with eight open collector outputs which will convey instrument status condition warning alarms such as no flow, sample mode, etc. Two of the digital outputs can be set so that there is +5V and +12V available on the 25 pin connector for control purposes, instead of digital outputs 0 and 1.

In the default jumper locations (refer to Figure 19) these two outputs will function normally as open collector outputs. If moved to the position closer to the 25 pin connector then the DO 0 will supply +12V and DO 1 will supply +5V.

The +12V and +5V supplies are limited to about 100mA each.

Each digital output is limited to a maximum of 400mA. The total combined currents should not exceed 2A.

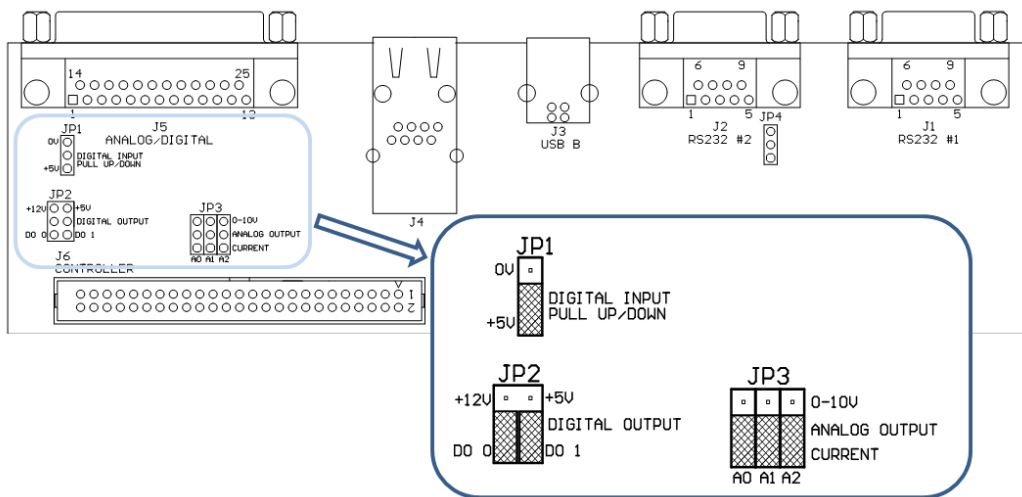

Figure 19 – 25 Pin Rear Panel PCA (Default Jumpers Highlighted)

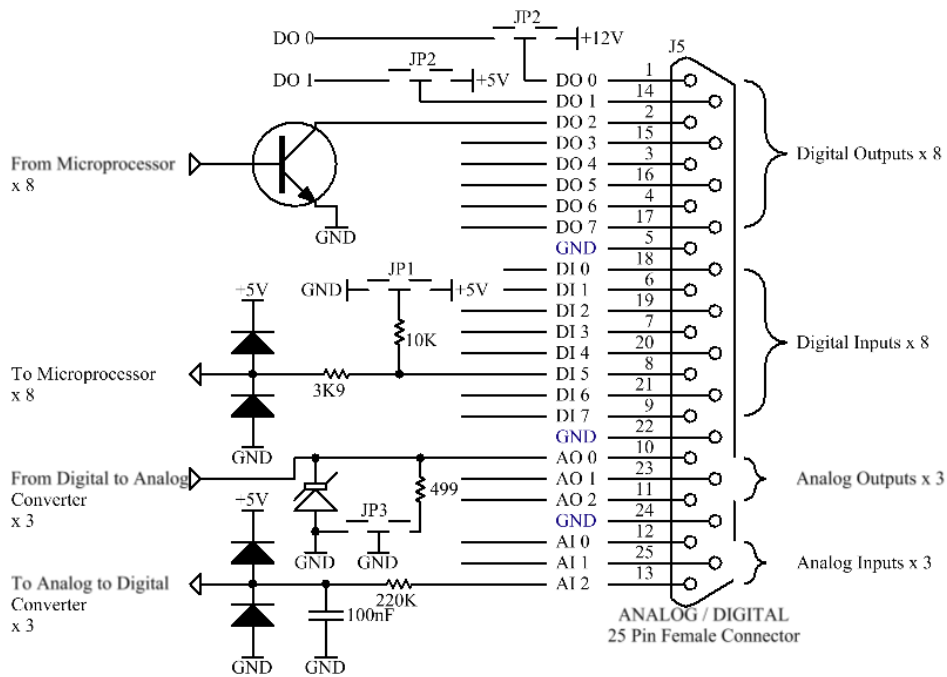

Figure 20 – External 25 Pin I/O Individual Pin Descriptions



CAUTION

The analog and digital inputs and outputs are rated to CAT I. Exceeding 12VDC or drawing greater than 400mA on a single output or a total greater than 2A across the eight outputs can permanently damage the instrument and void the warranty.

4.5 Logging Data

When the user receives the instrument from the factory it will have a default set of parameters already setup in the internal data logger. These select few parameters have been chosen for their relevance in assisting in troubleshooting the instrument.

4.5.1 Configure Instrument Internal Logging

In order to log data you must first specify a data logging interval. This is how often data will be logged to the USB memory stick. You can log a maximum of 12 parameters. These parameters can be selected by name or by parameter number using Appendix A (refer to Table 12).

Procedure

1. Open - **Main Menu** → **Communications Menu** → **Data Logging Menu** (refer to Section 3.4.21).
2. Select - **Data Log Interval** (adjust to the desired value).

3. Select - **Data Log Setup –Numeric** (select the parameter numbers you wish to log) **or** Select - **Data Log Setup –Text** (select the names of the parameters you wish to log).

4.6 Using Airodis Software to Download Data

4.6.1 Connecting the Instrument to Your PC

The instrument can communicate with a PC using RS-232 (Serial), TCP/IP (Network), Bluetooth or USB. Serial, Bluetooth and network communications do not require additional drivers. If you wish to connect using a USB cable, the driver must first be installed.

4.6.1.1 Connecting Over USB

If you wish to connect using USB, you will need to first install the Serinus USB driver.

Power on the instrument and connect it to your PC with a USB cable. You should receive a prompt if the driver needs to be installed. If not, open Device Manager (Under “System” in Control Panel), find the device and select “Update Driver Software”.

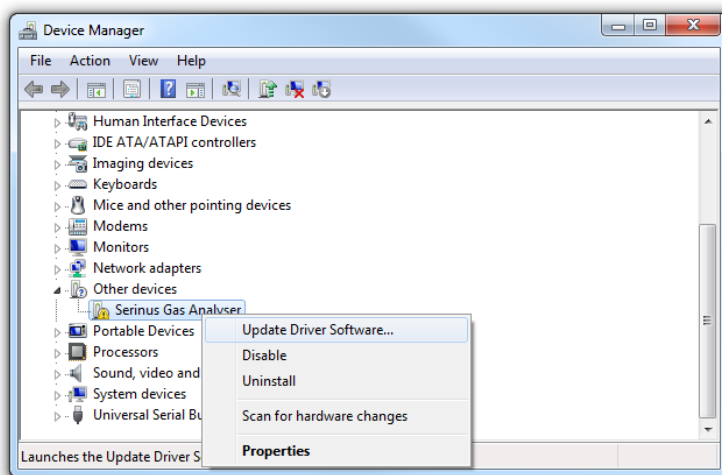

Figure 21 – Installing Driver Software (Device Manager)

When prompted where to search for the driver, select “**Browse my computer for driver software**”.

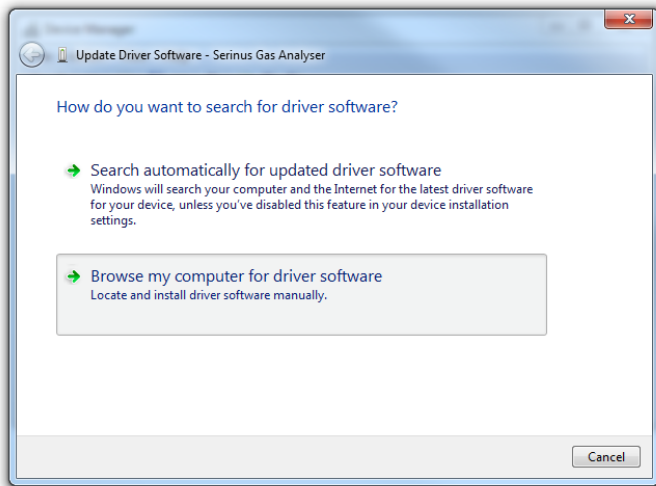

Figure 22 – Update Driver Popup

The Serinus USB driver is located on the green Ecotech resources USB stick under “\Drivers\Ecotech Analyser”. Select this directory and click **Next**.

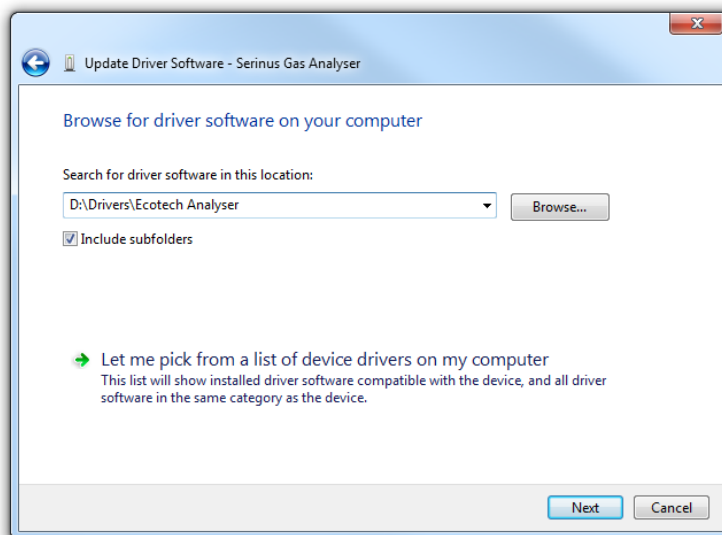

Figure 23 – Update Driver Popup (Directory Location)

If you receive a confirmation prompt to install the driver, select **Install**.

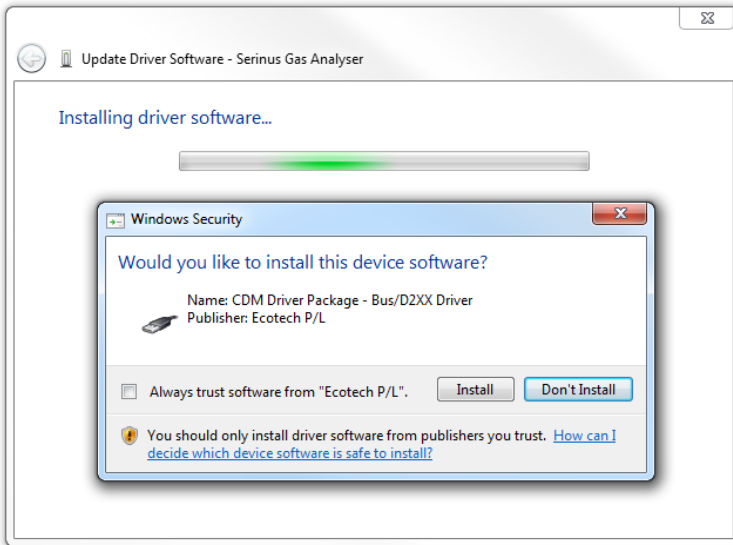

Figure 24 – Installing Driver Confirmation Prompt

If everything went smoothly, Windows will inform you that the driver was successfully installed.

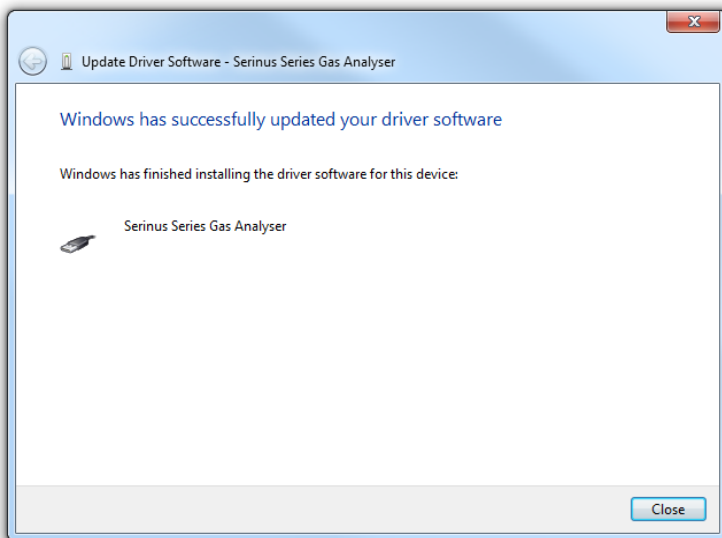

Figure 25 – Successful Driver Installation

4.6.1.2 Connecting Over Serial (RS-232)

The following steps outline how to setup the instrument for connection to a PC or datalogger (refer to Section 3.4.22).

Procedure

1. Open - **Main Menu** → **Communication Menu** → **Serial Communication Menu**.
2. Determine which RS232 Port you are physically making the connection with. Remember, multidrop is only supported on RS232 #2.
3. Select – **Baudrate** → **38400** - Accept (Set an appropriate baud rate, default is 38400).

4. Select - **Protocol** → **Advanced** - Accept.

If you are running Airodis in a multidrop configuration, ensure that the **Serial ID** is unique for each instrument on the chain.

4.6.1.3 Connecting Over Network (TCP/IP)

The following steps outline how to setup the instrument for connection to a PC or datalogger (refer to Section 3.4.27).

Procedure

1. Open - **Main Menu** → **Communication Menu** → **Network Menu**.
2. Select - **Protocol** → **Advanced** - Accept.
3. Select - **Start-up Mode** → **Set IP** - Accept.
4. Assign a unique static IP address to the instrument.
5. Reboot the instrument by cycling the power.

4.6.2 Installing Airodis

The user can download data from the instrument using either a full retail (paid) version of Airodis or with the demo version which is included on the green Ecotech resources USB stick. The demo version has limited functionality, but will allow you to download and export data from up to three instruments. If you do not already have Airodis, this can be obtained from Ecotech:

<http://www.airodis.com.au>

The installer is straightforward: Ensure you install the correct version for your operating system. If you are running 64-bit windows, install the 64-bit (x64) version. Otherwise, install the 32-bit (x32) version.

4.6.3 Configuring Airodis

1. Once installed, double click on the Airodis shortcut on the desktop to start Airodis Workspace Manager. You will be presented with the default workspace options. These will suffice for downloading data from the instrument.

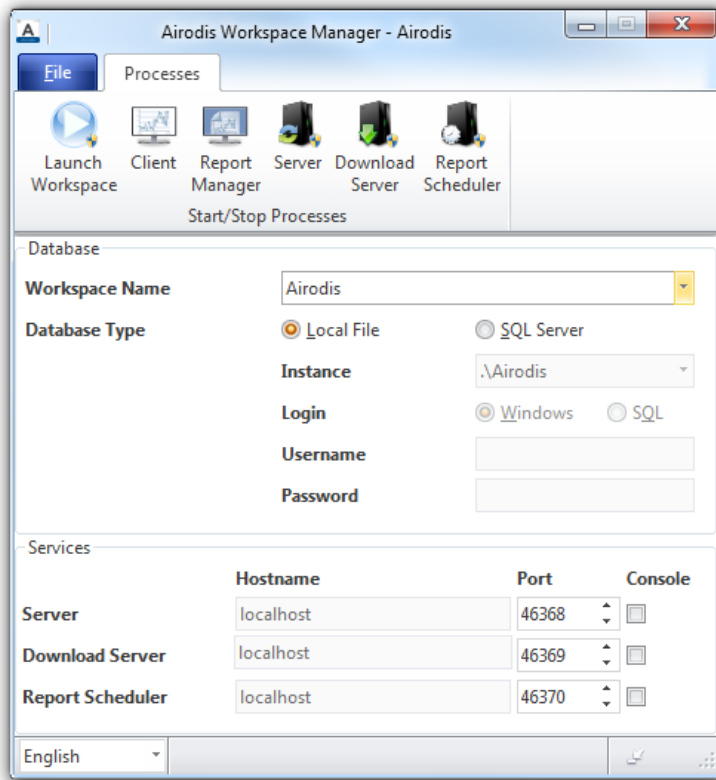

Figure 26 – Airodis Workspace Manager

2. Start the Client, Server and Download Server by single-clicking the toggle button for each. The client may prompt to register with Ecotech or install an update. Follow the prompts if it does.
3. Once the Client application has loaded, click **Home**→**Add Station**→**New Physical Station**.

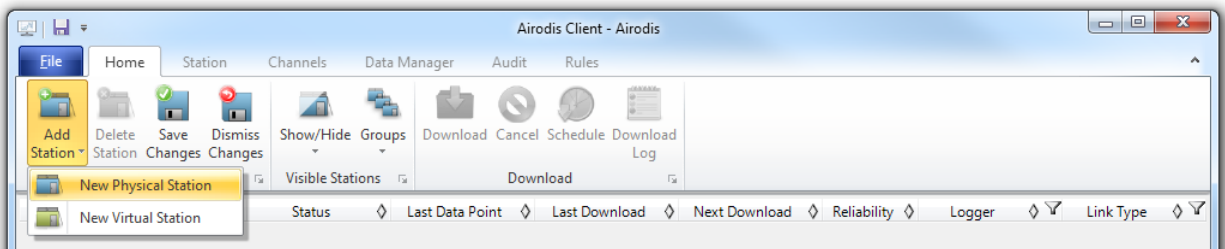

Figure 27 – Adding a New Station

4. This automatically brings you to the **Station** tab on the ribbon. Enter the communication details to connect to the instrument.

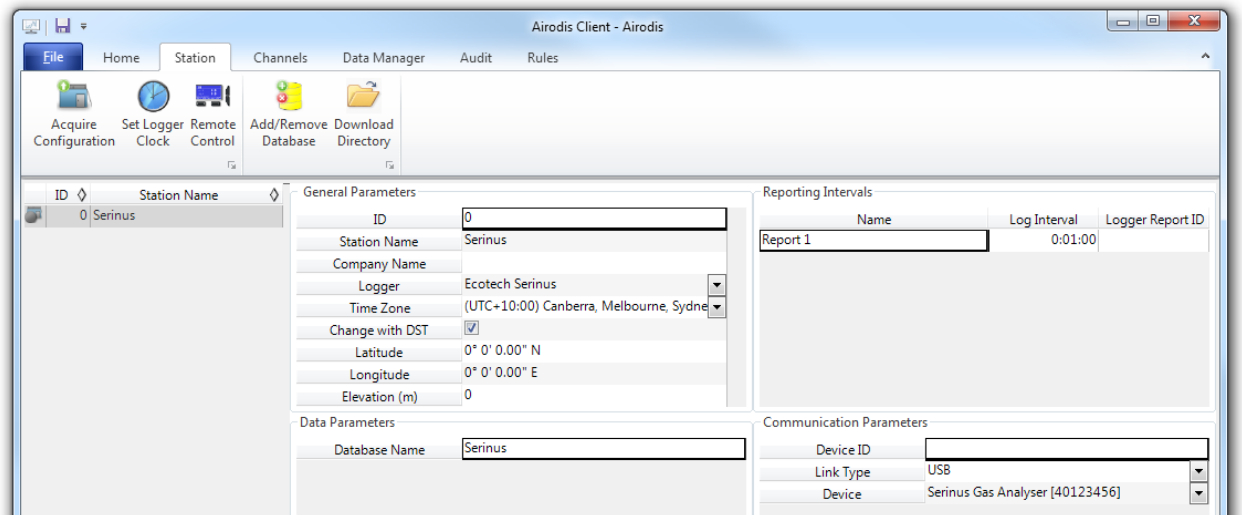

Figure 28 – New Station Connection

Table 5 – New Station Setup

Property	Description
Station Name	The name of the station. If you have other loggers, the name is used to distinguish them.
Logger	Set this to “Ecotech Serinus” when downloading from any Serinus series instrument. This will communicate with the instrument via the Advanced protocol. If using a network or serial connection, ensure that the Advanced protocol has also been selected on the instrument itself.
Time Zone	Set this to the time zone that the instrument is located in.
DST	Enable this option if you plan on changing the clock on the instrument with daylight savings. Leave this disabled if the clock does not shift during DST. The instrument will need to be adjusted manually for DST – it will not happen automatically.
Database Name	This is the name to be used for the table in the SQL database containing this station’s data. It must be unique for each station.
Device ID	Enter the Serial ID of the instrument. If you are not using multidrop; this can be set to “0” or left blank.
Link Type	Select the type of connection used to connect to the instrument. Different properties will appear depending on the link type selected. Align these settings with those of the instrument.
Log Interval	This needs to be the same as the Data Log Interval setting on the instrument.

Note: The available fields for communication parameters will change when you change the link type. You will need to set the communication parameters that have been defined on the instrument.

- Once the station has been created, save the station by clicking the Save shortcut icon or **File → Save**.

- Click Acquire Configuration. This will probe the instrument for a channel list. After a few seconds, the channel list should be visible in the **Channels** tab.

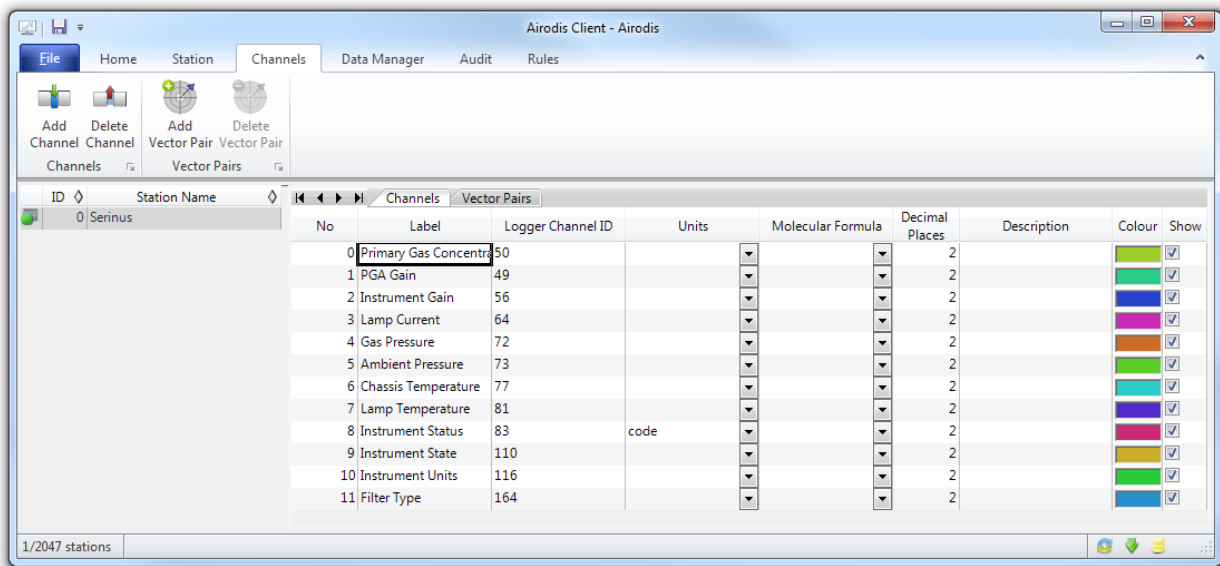

Figure 29 – Station Configuration (Channel List)

Note: If there was an error connecting to the instrument, a red dot will appear next to the station name in the station list (on the far left hand side). Hovering over the red dot will present you with an error message (refer to Figure 29).

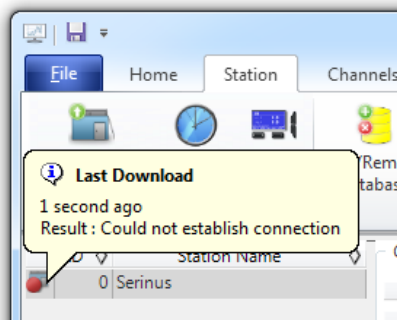

Figure 30 – Error Status Notification

- Select the Data Manager tab, click download. The Download Data window will appear. Select the appropriate time period that you wish to download and click Download.

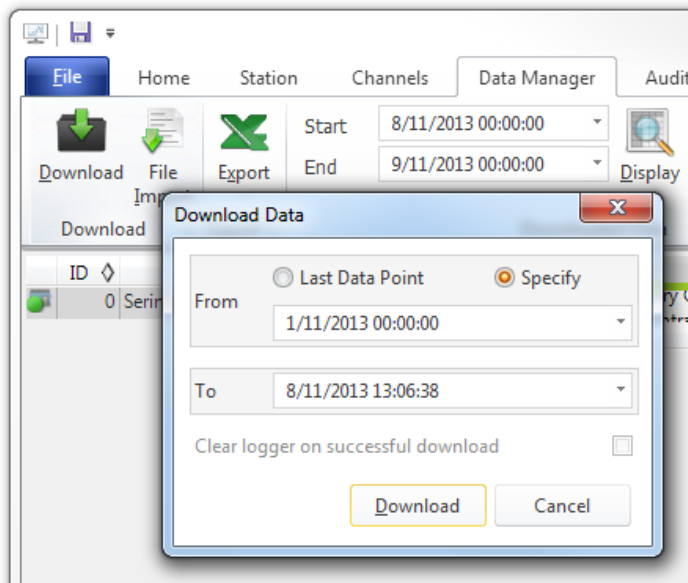

Figure 31 – Downloading Data

8. The status of the download will appear in the bottom-left corner of the window. You can also monitor the status of the download from the Home tab.

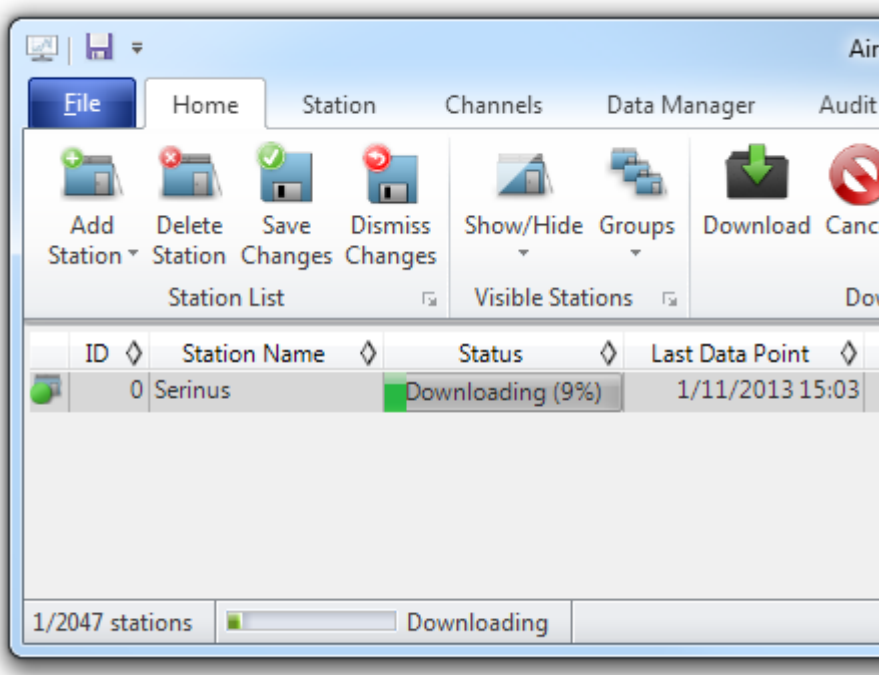

Figure 32 – Download Data Status

9. Data will become available in the data manager as it is downloaded. You can load data for a date range by entering the start and end dates and clicking Display. The selected data will be loaded into the data manager.

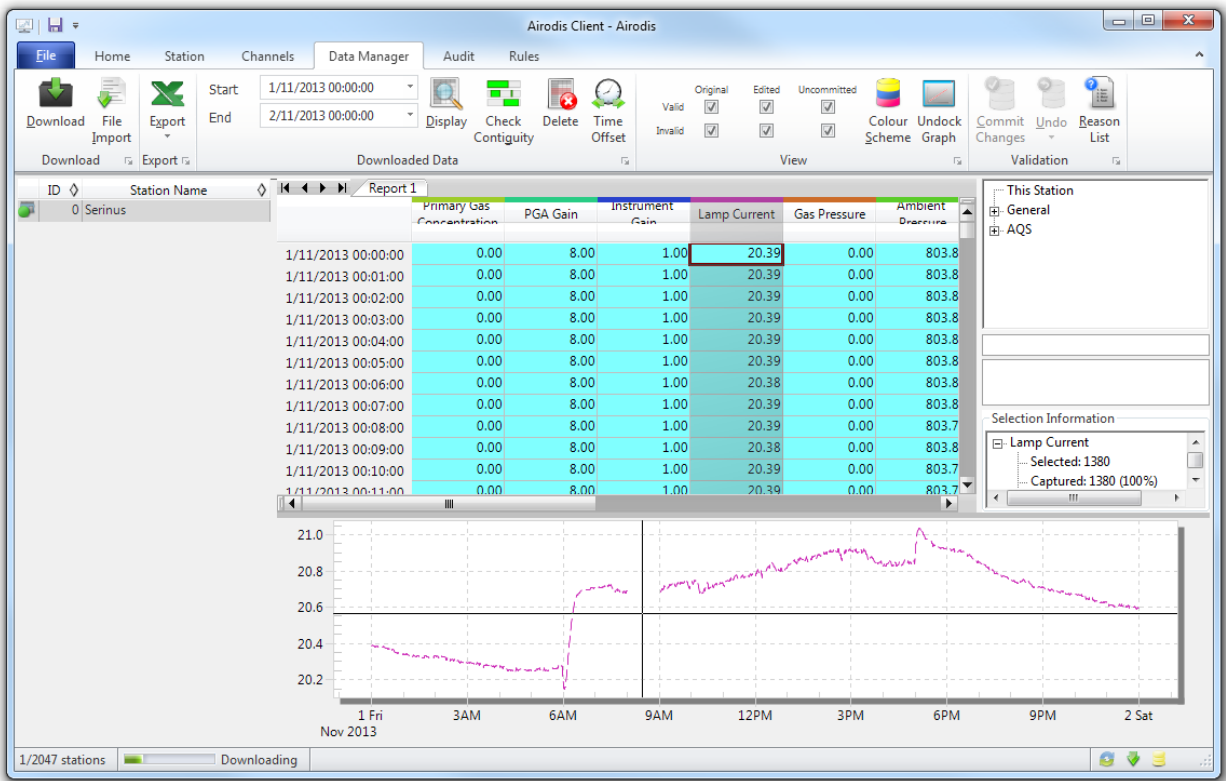

Figure 33 – Data Visibility

10. Data can be exported by clicking the Export function. This will allow you to save your data in CSV format, which can be loaded into another program such as Microsoft Excel. It is also possible to copy/paste (Ctrl + C / Ctrl + V) data directly from the Airodis data manager.

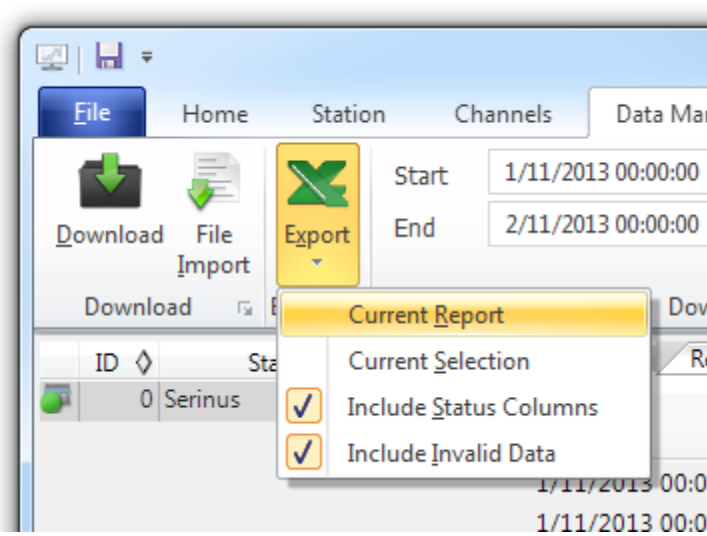
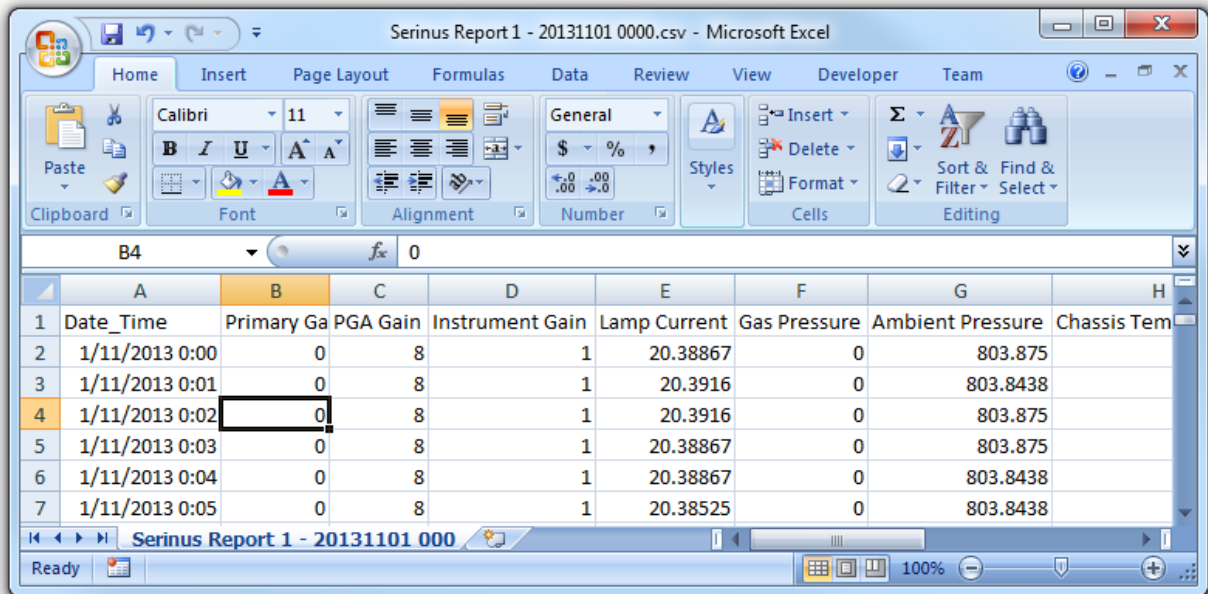

Figure 34 – Exporting Data

11. That’s it! The data has been downloaded from the instrument and exported to a standard CSV file.



	A	B	C	D	E	F	G	H
1	Date_Time	Primary Ga	PGA Gain	Instrument Gain	Lamp Current	Gas Pressure	Ambient Pressure	Chassis Tem
2	1/11/2013 0:00	0	8	1	20.38867	0	803.875	
3	1/11/2013 0:01	0	8	1	20.3916	0	803.8438	
4	1/11/2013 0:02	0	8	1	20.3916	0	803.875	
5	1/11/2013 0:03	0	8	1	20.38867	0	803.875	
6	1/11/2013 0:04	0	8	1	20.38867	0	803.8438	
7	1/11/2013 0:05	0	8	1	20.38525	0	803.8438	

Figure 35 – Data Download Complete

4.7 Serinus Remote App/Bluetooth

The Serinus Remote Application allows for any Android device (Tablet or Smartphone) to connect to an instrument.

The Serinus Remote Application allows the user to:

- Completely control the instrument using a remote screen displayed on the device.
- Download logged data and take snapshots of all the instrument parameters.
- Construct graphs from logged data or real time measurements.

The following sections cover installation, connection and use of the application.

4.7.1 Installation

The Serinus Remote Application can be found in the Google Play Store by searching for Ecotech or Serinus. Once found, choose to **Install** the application and **Open** to start the application.

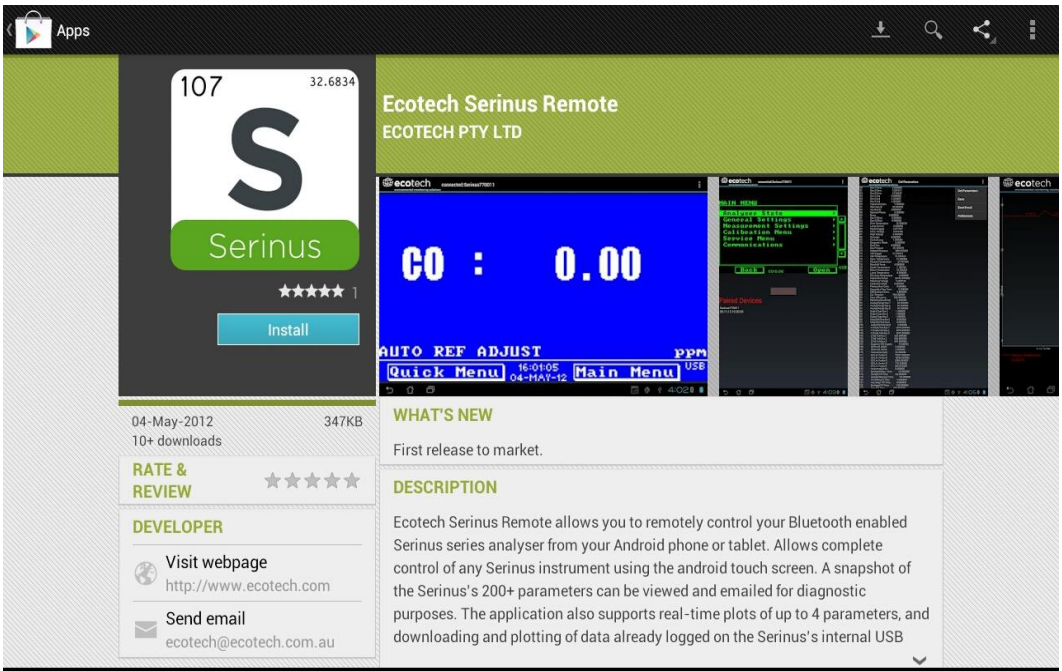

Figure 36 – Downloading the App from Google Play Store

Note: A menu containing additional features and functions can be accessed by entering the Options Menu (or similar) on your device. The location and format of this menu may vary.

4.7.2 Connecting to the Instrument

Procedure

1. Open - **Main Menu** → **Communications Menu** → **Bluetooth Menu** (to find the Bluetooth ID and PIN) (refer to Section 3.4.28).
2. Touch the Scan Serinus Analysers button at the bottom of the screen.
3. Select the Analyser ID from either the Paired Devices or the Other Available.
4. Input the PIN (if prompted) and press OK (refer to Section 3.4.28).

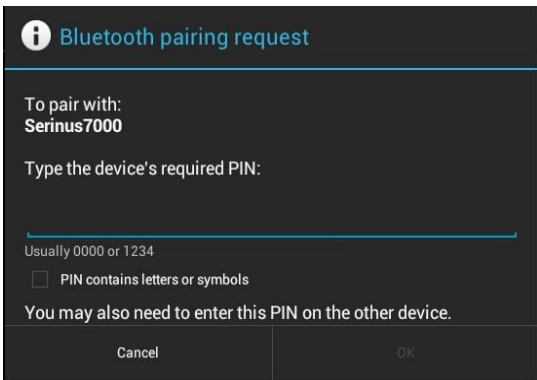

Figure 37 – Bluetooth Pairing Request

- A screen shot of the instrument's current screen should appear on your Smartphone or tablet. To disconnect press the back key/button on the device.

Note: Once the instrument has been paired with the device it will appear under “Paired Devices” and the PIN will not need to be entered again. Only one Bluetooth connection can be made to an instrument at any one time.

4.7.3 Instrument Control

Once connected the user has full control of the instrument. The range for remote control depends on the device's Bluetooth capabilities and any intervening obstructions, but is usually up to 30 meters.

Remote Screen Operation

With the exception of the number pad, all button functions/actions can be performed by touching the screen. This includes the selection buttons and the scroll buttons. Touching any part of the screen where there is not already a button also enacts the functions of the scroll buttons.

Home Screen

Touching the upper half of the screen increases the contrast and touching the lower half of the screen decreases contrast on the real instrument.

Menus

Touching the upper or lower half of the screen allows the user to scroll up and down respectively.

Right-hand Section of the Screen

Swiping from right to left brings up the number pad for entering numbers (swipe from left to right to hide the number pad).

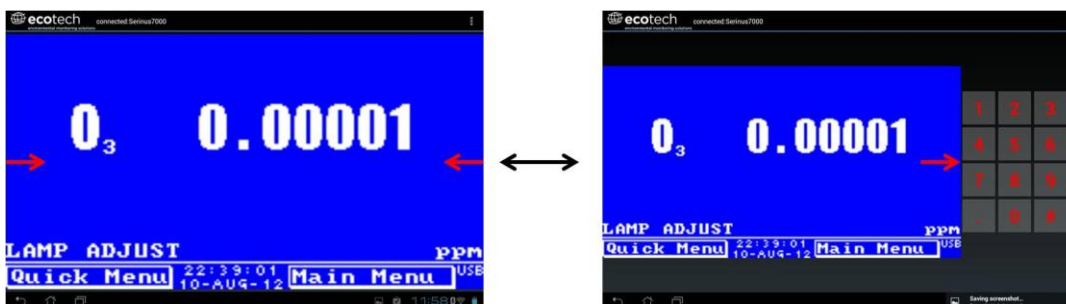

Figure 38 – Showing or Hiding the NumPad

Left-hand Section of the Screen

Swiping from left to right brings up a list of available analysers (swipe from right to left to hide the instrument list).

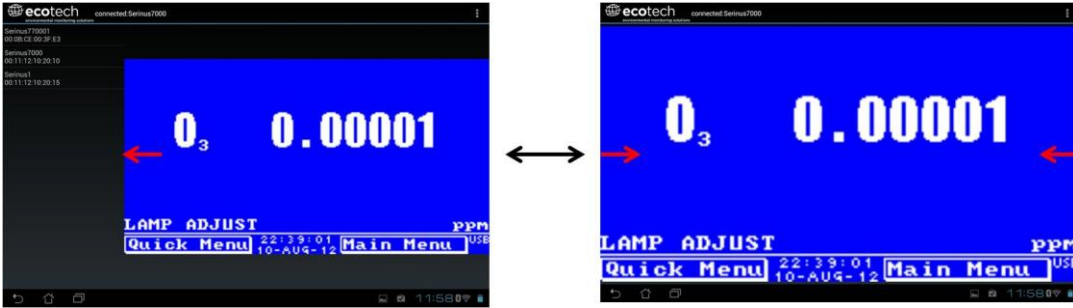

Figure 39 – Switching Analysers

Back Button

This button will enable the user to return to the selection screen, allowing connection to a different instrument.

Options Menu

The Options Menu is accessed by the grey button in the top right corner of the screen or pressing the Menu Button, depending on your Android device.

Refresh	Refresh the display.
Show/Hide NumPad	Show or hide the number pad.
Real Time Plot	Refer to Section 4.7.4.
Download	Refer to Section 4.7.5.
Get Parameters	Refer to Section 4.7.6.
Preferences	Refer to Section 4.7.7.

4.7.4 Real-Time Plot

Allows the user to view real-time plotting of up to four parameters at the same time. The user can also scroll from left to right, top to bottom or zoom in and out on the plot by swiping/pinching.

Once the plot is zoomed or scrolled, it enters into Observer Mode, meaning that auto-scaling is suspended. Press at the top of the screen (where it says Observer Mode) to return to Normal Mode.



Figure 40 – Real-Time Plot

Options Menu

The Options Menu is accessed by the grey button in the top right corner of the screen or pressing the menu button, depending on the Android device.

Start	Restarts graphing if it has been stopped and returns the graph to Normal Mode .
Stop	Stops collecting data. In this mode you can scroll the display without going into Observer Mode , because the system has no data collection to suspend. It is necessary to “Stop” data collection to set the interval.
Clear	Clears the window and restarts the graphing.
Save	Saves an image of the graph and accompanying data in the location specified in preferences (refer to Section 4.7.7). The user will also be asked whether they want to send the file and data via email. When saving the data, you can choose to Save All Data or Customise the length of the data by entering a time between five minutes and six hours. Only the data from the start of collection to that limit will be saved (although the plot will still appear exactly as it does on the screen).
Set Interval	While data collection is stopped, the user can specify the time intervals between collections.

4.7.5 Download

Download logged data from the USB memory stick inside the instrument. All data logged by the instrument to the USB memory stick over the period of time specified will be collected. Due to the slow connection speed of Bluetooth, this should only be used for relatively short sections of data. Downloading one days’ worth of one minute data is likely to take a couple of minutes.

Options Menu

Save	Generates a filename based on the start and end date/time specified. It saves the downloaded data in the location specified in preferences and asks to send the saved comma separated text file (.csv) as an attachment to an email. This file format does not
-------------	--

	include the parameter headings, just the values.
Send E-Mail	Sends an email with the parameter data in the body of the email, formatted as displayed (this includes the parameter name and the values).
Plot	Graphs the data that has been downloaded. The user is prompted to select which parameters to plot based on the parameters that were being logged (refer to Figure 35).
Preferences	Refer to Section 4.7.7.

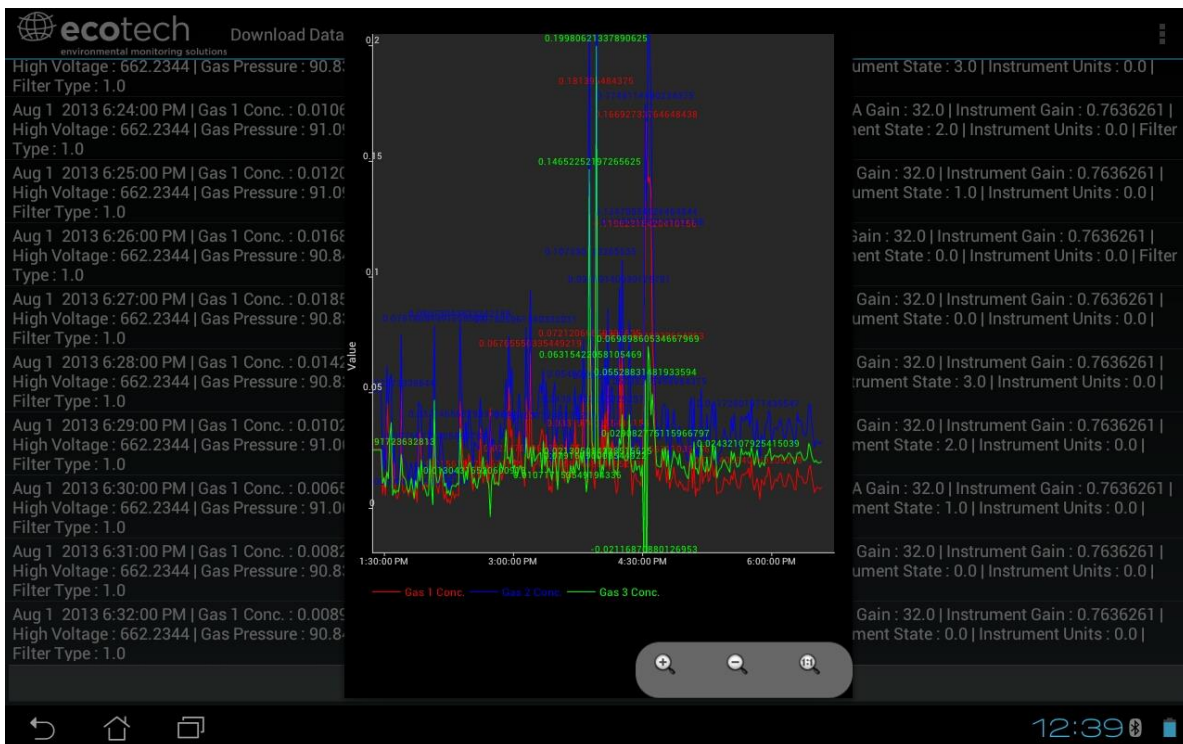

Figure 41 – Plot of Downloaded Data

4.7.6 Get Parameters

Download a list of parameters and corresponding values directly from the instrument. This list of parameters is a snap shot of the current instrument state and is very helpful in diagnosing any problems with the instrument.

Options Menu

Get Parameters	Refreshes the parameter list display.
Save	Generates a file name from the current date and time. It saves the parameter data in the location specified in preferences and asks to send the saved text file as an attachment to an email.
Send E-Mail	Sends an email with the parameter data in the body of the email, formatted as displayed.
Preferences	Refer to Section 4.7.7.

4.7.7 Preferences

The Preferences Menu allows the operator to adjust the directory settings, logged data format and the colour scheme settings. It can be accessed through the Options Menu in most windows.

Directory Settings

The operator can specify/select where to save the parameter lists, logged data and real time plots.

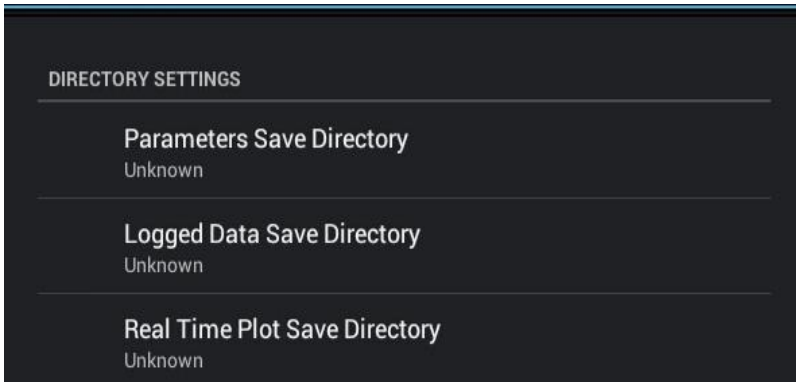

Figure 42 – Directory Settings

Logs Format

When downloading logged data, the parameters can be displayed on one line or each parameter on a separate line.

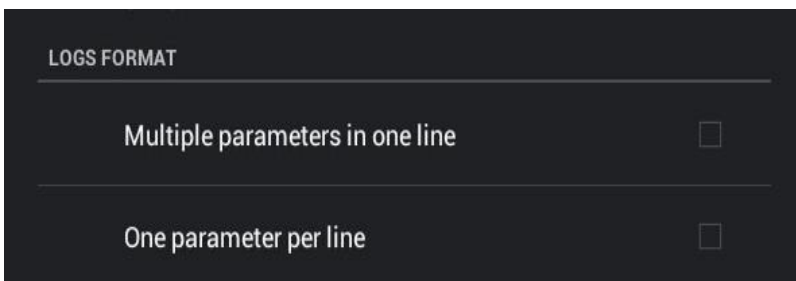

Figure 43 – Logs Format

Colour Theme Settings

Allows the user to choose a colour scheme for the remote screen either Matrix, Classic, Emacs or Custom.

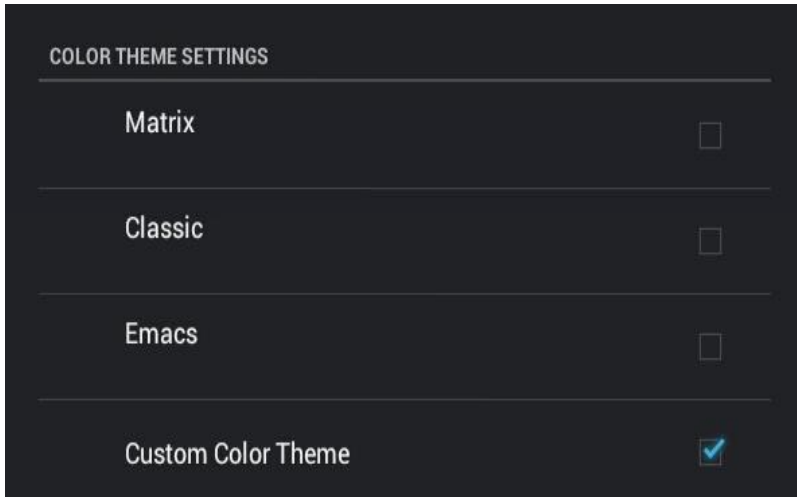

Figure 44 – Colour Theme Settings

5. Calibration

The following sections describe how to calibrate the span and zero points of the instrument as well as giving a brief overview of the calibration system.

Main Menu → Calibration Menu (refer to Section 3.4.10).

5.1 Overview

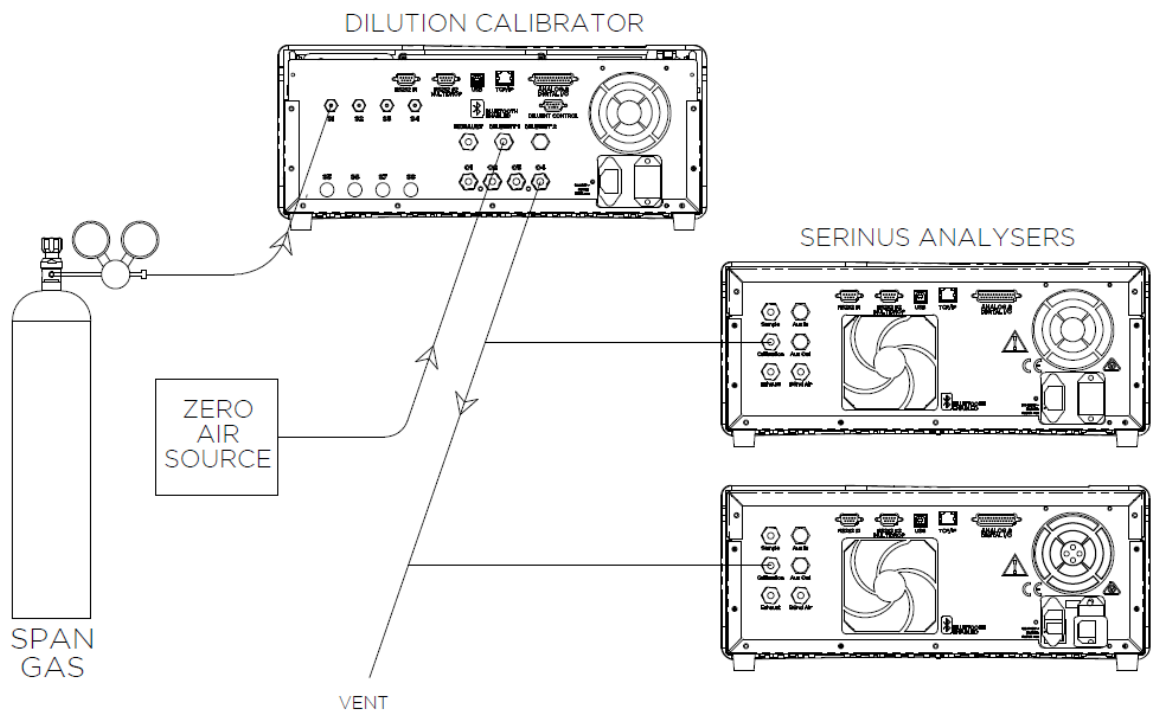

Figure 45 – Example of a Calibration System



CAUTION

All calibration gases **must** be supplied at ambient pressure to avoid damaging the instrument. If direct gas cylinder connection is required, high pressure Span/Zero options can be installed at time of ordering.

The calibration chapter consists of a:

- General discussion of calibration.
- Description of the pressure calibration procedure.
- Description of the Zero/Span precision check and calibration procedures.
- Description of the multipoint precision check procedure.
- Description of the NO₂ converter efficiency check procedure.

- Description of the NH₃ converter efficiency checks procedure.

The Serinus 44 analyser is a precision measuring device which must be calibrated against a known source of NO & NH₃ (e.g. a certified gas cylinder).

There are several different types of checks/calibrations performed:

- Level 1 Calibration – A simplified two-point instrument calibration used when instrument linearity does not need to be checked or verified. This check is typically performed on a monthly basis. Adjustments to the instrument response can only be made when performing level 1 calibration.
- Level 2 Calibration – A simple check of the instrument's response. Level 2 checks may be performed using non-certified reference sources and are most often used as a performance monitoring tool. Commonly referred to as a precision check, the instrument must not be adjusted.
- Multipoint Precision Check – A series of points (typically covering zero and 5 up-scale span points) are supplied to the instrument. They should cover the instruments intended full scale measurement range. These precision checks are used to determine the linearity of the instrument response across its operating range.
- Converter Efficiency Check – A measure of the efficiency of the system to convert the target gas for subsequent measurement. A converter efficiency check is performed on a regular basis to determine the converter performance and adjust the instruments response accordingly.

In general terms, the calibration process includes the following steps:

1. Establish a reliable and stable calibration source.
2. Perform a zero precision check or calibration – zero adjustments apply to the NO, NO₂ and NH₃ channels.
3. Calibrate the instrument against the NO reference – this will adjust the instrument response for the NO_x and N_x channels.
4. Perform a multipoint precision check using the NO reference. This determines the linear response of the instrument across the operating range.
5. Establish a reliable and stable calibration source (reference) for NH₃.
6. Check and adjust the NH₃ converter efficiency using the ammonia reference source.

Zero and span calibrations are frequently used to provide a two-point calibration or an indication of instrument stability and function.

A multipoint precision check is used to establish the relationship between instrument response and gas concentration over the instrument's full scale range.

Note: Zero calibrations are not recommended by Ecotech, but maybe be performed when specifically required by a user. Calibrating the zero tends to mask issues that should be addressed during maintenance/service.

Regulations generally require that the instrument be span calibrated against a certified calibration source any time:

- The instrument is moved.
- The instrument is serviced.
- The instrument's units are changed by the user between volumetric and gravimetric.
- Whenever the instrument characteristics may have changed.

Regulatory agencies establish the time intervals at which the instrument must be calibrated to ensure satisfactory data for their purposes.

5.2 Pressure Calibration

The pressure sensors are a vital component of the instrument operation and the pressure calibration should be checked on installation or whenever maintenance is performed.

A thorough leak check must be performed prior to performing a pressure calibration (refer to Section 6.3.5).

The pressure calibration can either be a two point calibration (one point under vacuum and another point at ambient pressure) or a single ambient point calibration when very minor adjustments are required.

Note: Ensure that the instrument has been running for at least one hour before any calibration is performed to ensure the instrument's stability. When performing a two point pressure calibration, it is advisable to perform the vacuum pressure calibration first.

5.2.1 Full Pressure Calibration

This section outlines how to perform a full pressure calibration. Using the required equipment follow the steps below to complete a full pressure calibration.

Note: This procedure is for firmware version 3.17.0007 and above. Ensure that the instrument has been running for at least one hour before the calibration is performed.

Note: Ensure units of measure are the same on both the barometer and instrument.

Equipment Required

- Barometer
- Vacuum source

Procedure

1. Disconnect all external tubing connected to the rear ports of the instrument except for the **AUX in Port** and **AUX Out Port** (for the external converter).
2. Open - **Main Menu** → **Calibration Menu** → **Pressure Calibration Menu** - (read note) - OK.

Note: This action will place the valve sequencing on hold and disable the ozone generator; normal sampling will be interrupted.

3. Edit - **Vacuum Set Pt.** - (Read displayed instructions) - OK.
4. Connect a vacuum source to **Exhaust Port** (refer to Figure 7) of instrument.
5. Wait 1 minute for the vacuum to purge the remaining O₃ from the system.
6. Connect a barometer to the **BGnd Air Port**, wait 2-5 minutes and ensure the pressure reading on the barometer has dropped and is stable.
7. Enter the barometer reading into the instrument - Accept.

Note: Only the reaction cell and auxiliary valve manifold pressure sensors will be calibrated as they will be exposed to vacuum.

8. Read displayed instructions - OK.
9. Turn off the vacuum source and wait 1 min or until the barometer reads ambient. Disconnect the barometer and vacuum source from the **BGnd Air Port** and **Exhaust Port**.
10. Wait 2-5 min, enter the ambient barometer reading into the instrument - Accept.

Note: All three sensors should now be displaying the current ambient pressure and they should be the same value within 3 torr of each other.

11. Back - **Pressure Calibration Menu** - (read note) - OK.

5.2.2 Ambient Point Pressure Calibration

Full pressure calibrations are generally recommended, however it is possible to calibrate only the ambient point in cases where only a minor ambient pressure adjustment is required.

Note: Ensure that the instrument has been running for at least one hour before any calibration is performed to ensure the instrument's stability.

Note: Ensure units of measure are the same on both the barometer and instrument.

Equipment Required

- Barometer

Procedure

1. Disconnect all external tubing connected to the rear ports of the instrument except for the **AUX in Port** and **AUX Out Port** (for the external converter).
2. Open - **Main Menu** → **Calibration Menu** → **Pressure Calibration Menu** - (read note) - OK.

Note: This action will place the valve sequence on hold; normal sampling will be interrupted.

3. Edit - **Ambient Set Pt.** - (Read displayed instructions) - OK.

4. Disconnect any external tubing connected to the rear ports of the instrument (**Sample Port**, **Exhaust Port**, etc.).
5. Wait 2-5 minutes and enter the ambient barometer reading into the instrument - Accept.

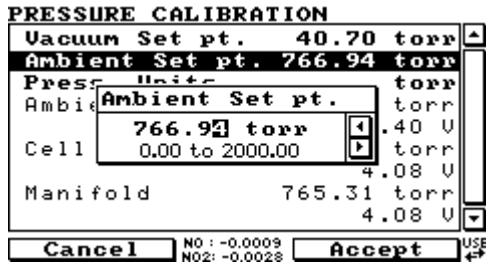

Figure 46 – Setting the Ambient Set Point

Note: All three sensors should now be displaying the current ambient pressure and they should be the same value within 3 torr of each other.

6. Back - **Pressure Calibration Menu** - (read note) - OK.

5.3 Zero Calibration

Zero checks and calibrations are used to determine the zero response of the instrument and set the offset of the instrument if required.

Performing a zero calibration will adjust the **Zero Offset NO, NO2 and NH3**. These offsets can be checked in the **Main Menu → Service Menu → Calculation Factors Menu** and should be very close to zero. A large offset may indicate a problem with the instrument (refer to Section 7).

Note: Ecotech encourages regular zero precision checks; however Ecotech recommends that the zero calibration only be performed when specifically required as it may mask issues that should be addressed during maintenance/service.

A zero calibration can be performed either through the **Calibration Port**, **Background Air Port** or the **Sample Port**. Refer to the instructions outlined in the next three sections:

Note: Ensure the instrument has been running for at least one hour before any calibration is performed to ensure sufficient stability.

5.3.1 Calibration Port

Equipment Required

- Zero source

Procedure

1. Ensure a suitable zero source is connected to the **Calibration port**.
2. Open - **Main Menu** → **Calibration Menu**.
3. Select - **Cal. Type** → **Manual** - Accept.
4. Select - **Zero Source** → **External** - Accept.
5. Select - **Cal. Mode** → **Zero** - Accept.
6. Allow the instrument time to achieve a stable response.
7. Enter - **Zero Calibrate (NO) or (NO2) or (NH3)** - OK.
8. Select - **Cal. Mode** → **Measure** - Accept (To return to sample measure).

5.3.2 Sample Port

Equipment Required

- Zero source

Procedure

1. Ensure a suitable zero source is connected to the **Sample Port**.
2. Open - **Main Menu** → **Calibration Menu**.
3. Select - **Cal. Type** → **Manual** - Accept.
4. Select - **Zero Source** → **External** - Accept.
5. Select - **Cal. Mode** → **Measure** - Accept.
6. Allow the instrument time to achieve a stable response.
7. Enter - **Zero Calibrate (NO) or (NO2) or (NH3)** - OK.
8. Disconnect the zero source and reconnect the sample line to the **Sample Port**.

5.3.3 Background Air Port

Equipment Required

- Zero source

Procedure

1. Ensure a suitable zero source is connected to the **BGnd Air Port**.
2. Open - **Main Menu** → **Calibration Menu**.
3. Select - **Cal. Type** → **Manual** - Accept.
4. Select - **Zero Source** → **Internal** - Accept.
5. Select - **Cal. Mode** → **Zero** - Accept.
6. Allow the instrument time to achieve a stable response.
7. Enter - **Zero Calibrate (NO) or (NO2) or (NH3)** - OK.

8. Select - **Cal. Mode** → **Measure** - Accept (To return to sample measure).

5.4 Span Calibration

A span calibration is a calibration performed at the upper end of the instrument's measurement range. Ecotech recommends calibration at 80% of the full scale measurement or operating range of the instrument.

While the instrument range is commonly set as a default 0-500ppb, this is widely recognised as no longer being valid with modern digital communication and most regulators will now recommend a range more suited to local conditions.

Note: Ensure that the instrument has been running for at least one hour before any calibration is performed to ensure the instrument's stability.

The S44 instrument is essentially an NO monitor and should be calibrated as such.

During a span calibration, the instrument response to NO is adjusted and will correct the instrument response for the NO_x and N_x channels.

Calibration gas can be supplied through either the **Calibration Port** or **Sample Port**. Follow the relevant instructions below:

Note: If operating the instrument for the first time, ensure the system has been allowed sufficient time to stabilize and for all gas lines and pathways to equilibrate and condition before performing a calibration.

5.4.1 Conditioning the Ammonia (NH₃) Sample and Calibration Lines

NH₃ is a very "sticky" gas and both the measurement and calibration systems need to be properly conditioned before commencement of any monitoring can begin.

Upon first installation, it is highly recommended that the S44 be allowed to sample NH₃ calibration gas for several hours (or overnight) to ensure the (NH₃) gas line is conditioned and is free from other contaminants which may affect your (NH₃) results.

It is also highly recommended that the **Ammonia (NH₃)** gas be delivered by a Gas Dilution calibrator (SerinusCal) which has been isolated and dedicated to (NH₃) gas/testing use only.

This will prevent the chance of contamination of other gases and therefore provide a better gas response and converter efficiency.

Note: Ensure the calibration system provides sufficient excess flow as compared to the system draw.

5.4.2 Calibration Port

Equipment Required

- Span source

Procedure

1. Ensure a suitable span source is connected to the **Calibration Port**.
2. If diluting the gas with a dilution calibrator, set the output concentration to 80% of the instrument measurement range.
3. Open - **Main Menu** → **Calibration Menu**.
4. Select - **Cal. Type** → **Manual** - Accept.
5. Select - **Cal. Mode** → **Span** - Accept.
6. Let the instrument stabilise, typically 20 minutes.
7. Enter - **Span Calibrate NO_x** - (Enter the span output concentration) - Accept.
8. Select - **Cal. Mode** → **Measure** - Accept (To return to sample measure).

Note: If calibrating with a reference cylinder containing NO₂, ensure that the expected value is based on the certified NO_x concentration rather than the certified NO value.

5.4.3 Sample Port

Equipment Required

- Span source

Procedure

1. Ensure suitable span source is connected to the **Sample Port**.
2. If diluting the gas with a dilution calibrator, set the output concentration to 80% of the instrument measurement range.
3. Open - **Main Menu** → **Calibration Menu**.
4. Select - **Cal. Type** → **Manual** - Accept.
5. Select - **Cal. Mode** → **Measure** - Accept.
6. Let the instrument stabilise, typically 20 minutes.
7. Enter - **Span Calibrate NO_x** - (Enter the span output concentration) - Accept.
8. Disconnect the span source and reconnect the sample line to the **Sample Port**.

Note: If calibrating with a reference cylinder containing NO₂, ensure that the expected value is based on the certified NO_x concentration rather than the certified NO value.

5.4.4 Manual Instrument Gain and Offset Adjustments



CAUTION

Manual adjustment of the Instrument Gain does not take into account the PTF correction and can lead to an incorrect calibration

At times it may be desirable to manually adjust the instrument's gain and offsets. Typically this option is only used when an instrument calibration has been corrupted and the user wishes to reset the instrument response factors prior to performing a new calibration.

To manually adjust the instrument follow the below procedure:

1. Open - **Main Menu** → **Service Menu** → **Calculation Factors Menu**.
2. Edit - **Instrument Gain** - (Adjust as required. 1 is the default) - Accept.
3. Edit - **Zero Offset NO** - (Adjust as required. 0 is the default) - Accept.
4. Edit - **Zero Offset NO2** - (Adjust as required. 0 is the default) - Accept.
5. Edit - **Zero Offset NH3** - (Adjust as required. 0 is the default) - Accept.

5.5 Precision Check

Similar to a normal zero or span calibration, a precision check is a Level 2 calibration that may be performed using a non-certified reference. The instrument is supplied with a known concentration of span gas (or zero air) and the instrument's response observed. However, no adjustment to the instrument response is made during a precision check.

Note: Ensure that the instrument has been running for at least one hour before any calibration is performed to ensure the instrument's stability.

A precision check can be performed either manually via the **Sample Port** or **Calibration Port** or can also be performed automatically using the Timed Mode (refer to Section 3.4.10.2).

Procedure

1. Supply the instrument with a zero source (refer to Section 5.3 for the procedure of setting up a zero, but do not do a **Zero Calibrate (NO) or (NO2) or (NH3)**).
2. Observe and record the measurement from the instrument.
3. Supply the instrument with a span source (refer to Section 5.4 for the procedure of setting up a span but do not do a **Span Calibrate NOx**).
4. Observe and record the measurement from the instrument.
5. Check both readings against your local applicable standards.

If an instrument fails a span precision check (based on the users local applicable standards), perform a span calibration (refer to Section 5.4).

If an instrument fails a zero precision check (based on the users local applicable standards), resolve the issue by referring to Section 6).

5.6 Multipoint Precision Check

A multipoint precision check is used to determine the linear response of the instrument across its operating range. The instrument is supplied with span gas at multiple known concentrations, typically a zero point and at least four up-scale points, spread across the operating range of the instrument. The observed concentrations are compared to expected values and the linearity of the instrument assessed against local applicable standards.

Note: The instrument is inherently linear and the instrument gain should **not** be adjusted at each individual point. Non-linearity indicates a problem with the instrument (refer to Section 7). Ensure that the instrument has been running for at least one hour before any calibration is performed to ensure the instrument's stability.

Several methods for producing multiple known concentrations are available to use, such as connecting multiple certified gas cylinders at different concentrations. However, Ecotech strongly recommends the use of a dilution calibrator and a certified cylinder of NO at an appropriate concentration (typically a cylinder of 40 to 100 ppm NO, balance in Nitrogen).

1. Connect your calibration system to the **Calibration Port** of the instrument (Ecotech recommends the Serinus Cal 2000, refer to Figure 45).
2. Generate and record the displayed span concentrations for (at least) five stepped points (of known concentrations) evenly spaced across the instruments measurement range (see the example below).
3. Then using a program such as MS Excel, create an X Y scatter plot of expected concentration versus the recorded instrument response and use linear regression to calculate the line of best fit and the correlation factor (R^2) – refer to the users local applicable standards.

Example for an instrument measurement range of 500 ppb:

- a. For the 1st concentration, set the gas dilution calibrator to supply **400 ppb** NOx gas to the instrument.
- b. Allow the instrument to sample the calibration gas until a prolonged stable response is achieved (the amount of time this takes is impacted by the calibration setup). Record the instrument response.
- c. Repeat the above steps using concentrations of **300ppb, 200ppb, 100ppb** and a **Zero** point.
- d. Graph the results and use linear regression to determine a pass or fail as per your applicable local standards.

$$y = mx + c$$

Note: To highlight hysteresis errors, it is advisable to run the multipoint check in both *descending* and *ascending* order - refer to applicable local standards.

Multipoint Linearity Check (NO gas)

Cal. Point	Zero flow (sccm)	Span flow (sccm)	Calculated NOx (ppb)	Expected NOx (ppb)	Measured NO	Measured NO2	Measured NOx	Measured NH3	Measured Nx
Zero	3000	0.00	0.00	0.0	0.5	0.0	0.5	0.5	1.0
20% FS	3000	5.00	100	100.0	99.6	0.2	99.8	0.4	100.2
40% FS	3000	10.00	199	199.0	198.0	0.6	198.6	0.5	199.1
60% FS	3000	15.00	299	299.0	299.0	0.4	299.4	0.9	300.3
80% FS	3000	20.00	397	397.0	399.0	0.2	399.2	0.8	400.0
Zero	3000	0.00	0.00	0.0	0.4	0.1	0.5	0.5	1.0

Note: Do not fill in the shaded cells

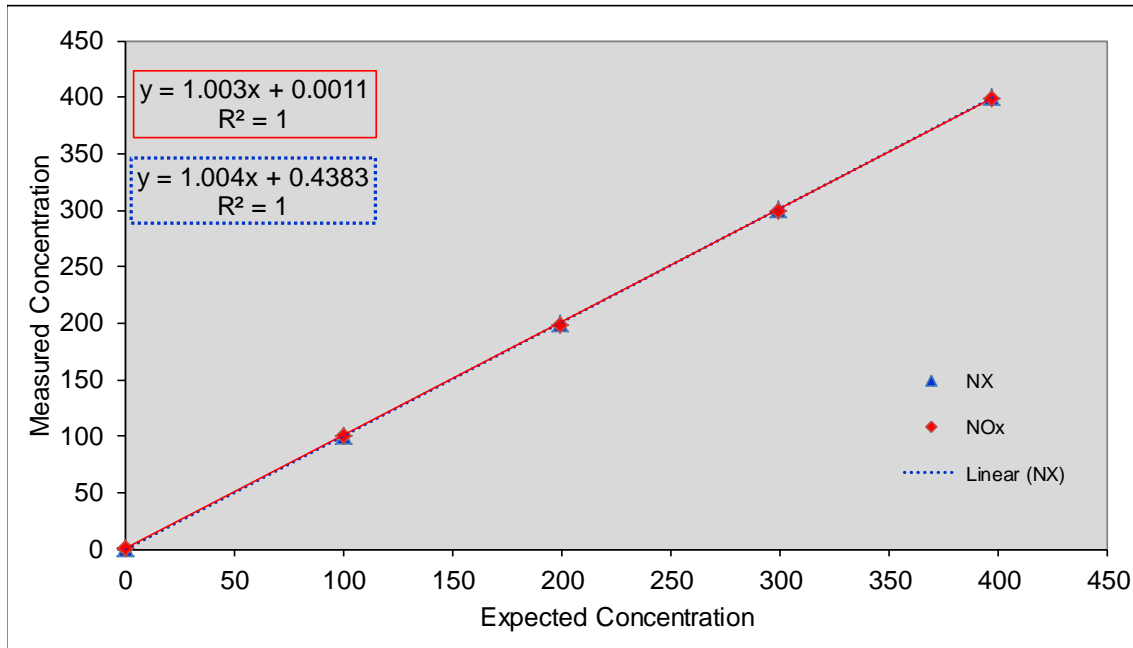

	NOx	Nx
Standard error (Y about X)	0.87	0.92
Error as %FS	0.17%	0.18%

Standard Error of Y about X must be less than 1% of FS value for both NOx and Nx channels.

PASS/ FAIL	PASS
---------------	-------------

Figure 47 – Multipoint Calibration Results Example

If unsatisfactory results are observed, please refer to Section 7 - troubleshooting.

5.7 NO₂ to NO Converter Efficiency

The efficiency of the NO₂ to NO converter can impact readings and may degrade over time. The converter efficiency must be measured to ensure the efficiency is 96% or greater and to compensate for converter inefficiencies impacting results.

In the S44 there are two NO₂ to NO converter coils and both of these needs to be tested on a regular basis (refer to Section 1.5.8).

The NO₂ converter efficiency value displayed in the **Main Menu** → **Service Menu** → **Calculation Factors menu** only applies to the NO_x path converter coil, the efficiency of the second coil for the N_x channel is encompassed in the NH₃ converter efficiency value.

The following procedures describe the process for testing the efficiency for both converter coils and adjusting the NO₂ converter efficiency for the NO_x channel coil.

Required Equipment

- Gas Dilution Calibrator which can perform a Gas Phase Titration (GPT) (such as a Serinus Cal 2000/3000) with ozone.
- A NO gas cylinder reference standard
- Zero Air Generator
- Loop of tube (to bypass external converter)

To measure and correct converter efficiency the following equation is used:

$$EFF_{Conversion} = \frac{\Delta[NO_2]}{\Delta[NO]} \times 100 = \frac{[NO_2]_{FINAL} - [NO_2]_{ORIG}}{[NO]_{ORIG} - [NO]_{FINAL}} \times 100$$

Equation 4 – Calculation for NO₂ Converter Efficiency of the NO_x path

$[NO_2]_{ORIG}$ = NO₂ measurement obtained by running a stable concentration of NO span gas through the instrument.

$[NO]_{ORIG}$ = NO measurement obtained by running a stable concentration of NO span gas through the instrument.

$[NO]_{FINAL}$ = NO measurement obtained by running a stable concentration of NO₂ span gas (as generated by reacting O₃ with NO in a GPT calibrator) through the instrument.

$[NO_2]_{FINAL}$ = NO₂ measurement obtained by running a stable concentration of NO₂ span gas (as generated by reacting O₃ with NO in a GPT calibrator) through the instrument.

To assess the converter efficiency for the N_x coil the following equation is used:

$$EFF_{Conversion} = \frac{\Delta[Nx - NO]}{\Delta[NO]} \times 100 = \frac{[Nx - NO]_{FINAL} - [Nx - NO]_{ORIG}}{[NO]_{ORIG} - [NO]_{FINAL}} \times 100$$

Equation 5 – Calculation for NO₂ Converter Efficiency of the NX path

$[Nx - NO]_{ORIG}$ = Calculation of the N_x measurement minus the NO measurement, obtained by running a stable concentration of NO span gas through the instrument.

$[NO]_{ORIG}$ = NO measurement obtained by running a stable concentration of NO span gas through the instrument.

$[Nx - NO]_{FINAL}$ = Calculation of N_x measurement minus the NO measurement, obtained by running a stable concentration of NO₂ span gas (as generated by reacting O₃ with NO in a GPT calibrator) through the instrument.

$[NO]_{FINAL}$ = NO measurement obtained by running a stable concentration of NO₂ span gas (as generated by reacting O₃ with NO in a GPT calibrator) through the instrument.

5.7.1 Single Point NO₂ to NO Converter Efficiency Check

This procedure is a simple check to ensure the NO₂ converter efficiency for the both the NO_x path and the N_x path are within limits and have not significantly deteriorated.

Equipment Required

- Gas Dilution Calibrator which can perform a Gas Phase Titration (GPT) (such as a Serinus Cal 2000/3000) with ozone.
- NO gas cylinder reference standard.
- Zero Air Generator.
- Loop of tubing (to bypass external converter).

Procedure

1. Bypass the external converter by connecting the Aux In and Aux Out ports on the rear panel of the instrument with a loop of tubing.
2. Open - **Main Menu** → **Calibration Menu**.
3. Note down the current values for **Conv. Efficiency NO2** and **Conv. Efficiency NH3**.
4. Edit - **Conv. Efficiency NO2** - (change to 100%) - Accept.
5. Edit - **Conv. Efficiency NH3** - (change to 100%) - Accept.
6. Supply the instrument with a point of zero air.
7. Allow the instrument to achieve a prolonged, stable measurement response and note down the NO, NO₂ and N_x values for reference only. If you get greater than 3 to 5 ppb you need to troubleshoot the instrument and calibration system before continuing with this procedure.
8. Supply the instrument with NO span gas at a concentration of 80% of the full-scale monitoring range of the particular instrument.
9. Allow the instrument to achieve a prolonged, stable measurement response and note down the NO, NO₂ and N_x values. Label them as [NO]_{ORIG}, [NO₂]_{ORIG} and [N_x - NO]_{ORIG} after you perform the calculation of N_x - NO.
10. Without changing the previous span concentration, turn on the O₃ generator in the GPT system, and react the NO and O₃ to produce NO₂. The O₃ concentration should be no more than 80% of the supplied NO concentration; there should still be excess un-reacted NO measured by the instrument.
11. Allow the instrument to achieve a prolonged, stable measurement response and note down the NO, NO₂ and N_x values. Label them as [NO]_{FINAL}, [NO₂]_{FINAL} and [N_x - NO]_{FINAL} (after the user performs the calculation of N_x - NO).
12. Use these noted measurements to calculate the converter efficiencies of each coil using Equation 4 and Equation 5.
13. If the converter efficiencies are 96% or greater, the converters are working well, return the converter efficiencies to their original values. Adjustments to the converter efficiencies should only be made based on a multipoint check (refer to Sections 5.7.2 for NO₂ converter efficiency adjustment and Section 5.8.2 for NH₃ converter efficiency adjustment). If either of the converter efficiencies is less than 96%, the test has failed. The converter may require replacement or try repeating the test and make sure there are no issues with your calibration system. Ensure there is no drift in NO span or generated O₃ during the test.

14. Open - **Main Menu** → **Calibration Menu**.
15. Edit - **Conv. Efficiency NO₂** - (change back to original efficiency) - Accept.
16. Edit - **Conv. Efficiency NH₃** - (change back to original efficiency) - Accept.
17. Remove the bypass loop and reconnect the external converter.

5.7.2 Multipoint NO₂ to NO Converter Efficiency Adjustment

A multipoint converter efficiency check is performed to determine the actual converter efficiency across the range of the instrument. The instrument is then adjusted accordingly.

In the S44, the **Conv. Efficiency NO₂** value displayed in the **Main Menu** → **Service Menu** → **Calculation Factors Menu** only applies to the NO_x path converter coil. The efficiency of the second coil for the N_x path in conjunction with the external converter and other losses throughout the instrument make up the **Conv. Efficiency NH₃**. Therefore the NH₃ efficiency should not be adjusted as part of this procedure.

Note: For the following procedure the results for the NH₃ and N_x channels can be ignored; bypassing the NH₃ converter is not required.

Equipment Required

- Gas Dilution Calibrator which can perform a Gas Phase Titration (GPT) (such as a Serinus Cal 2000/3000) with ozone.
- NO gas cylinder reference standard.
- Zero Air Generator.

Procedure

1. Open - **Main Menu** → **Calibration Menu**.
2. Note down the current values for **Conv. Efficiency NO₂**.
3. Edit - **Conv. Efficiency NO₂** - (change to 100%) - Accept.
4. Supply the instrument with zero air from your gas dilution calibrator.
5. Allow the instrument to achieve a prolonged, stable measurement response and note down the NO, NO₂ and N_x values for reference only. If you get greater than 3 to 5 ppb you need to troubleshoot the instrument and calibration system before continuing with this procedure.
6. Supply the instrument with NO span gas at a concentration of 80% of the full-scale monitoring range of the particular instrument.
7. Allow the instrument to achieve a prolonged, stable measurement response and note down the NO, NO₂ and N_x values. Label them as [NO]_{ORIG}, [NO₂]_{ORIG} and [N_x - NO]_{ORIG} after you perform the calculation of N_x - NO.
8. Without changing the previous span concentration, turn on the O₃ generator in the GPT system, and react the NO and O₃ to produce NO₂. The O₃ concentration should be no more than 80% of the supplied NO concentration; there should still be excess un-reacted NO measured by the instrument.

9. Allow the instrument to achieve a prolonged, stable measurement response and note down the NO, NO₂ and N_x values. Label them as [NO]_{FINAL}, [NO₂]_{FINAL} and [N_x – NO]_{FINAL} (after the user performs the calculation of N_x – NO).
10. Use these noted measurements to calculate the converter efficiency using Equation 4.
11. Repeat steps 8 to 10 for a minimum of two more O₃ points, spread across the measurement range of the instrument and note down the results.
12. Average the efficiencies. If the calculated result is above 96% efficient than the test has passed enter the result as the new **Conv. Efficiency NO2**. If the converter efficiency is below 96%, the test has failed and the converter may require replacement. Try repeating the test and make sure there are no issues with your calibration system. Ensure there is no drift in NO span or generated O₃ during the test.
13. Open - **Main Menu** → **Calibration Menu**.
14. Edit - **Conv. Efficiency NO2** - (enter averaged efficiency result (only if test passed)) - Accept.

5.8 NH₃ Converter Efficiency

The efficiency of the external converter, NH₃ scrubber and second NO₂ to NO converter coil must be determined to correctly measure NH₃. The combined losses of all three components are referred to as the NH₃ Converter Efficiency. The NH₃ converter efficiency should be greater than 80% for the instrument to be operating correctly.

To calculate and correct converter efficiency the following equation is used:

$$EFF_{Conversion} = \frac{[NH_3]_{MEASURED}}{[NH_3]_{SUPPLIED}} \times 100$$

Equation 6 – Calculation for NH₃ Converter Efficiency

[NH₃]_{MEASURED} = NH₃ measurement obtained by running a stable concentration of NH₃ span gas through the instrument with the converter efficiency field set to 100.

[NH₃]_{SUPPLIED} = NH₃ concentration supplied from the gas dilution system via NH₃ gas standard.

5.8.1 Single Point NH₃ Converter Efficiency Check

This procedure is a simple check to ensure the converter efficiency for the NH₃ converter has not drifted significantly from the expected value (from a previous multipoint adjustment). The NO, NO₂ and NO_x values can be ignored during this test.

Equipment Required

- Gas Dilution Calibrator (such as a Serinus Cal 1000/2000/3000)
- NH₃ gas cylinder reference standard
- Zero Air Generator

Procedure

1. Open - **Main Menu** → **Calibration Menu**.
2. Note down the current value for **Conv. Efficiency NH3**.
3. Edit - **Conv. Efficiency NH3** - (change to 100%) - Accept.
4. Supply the instrument with a known concentration of NH₃ span gas at roughly 80% of the full-scale monitoring range of the particular instrument. Label this value as [NH₃]_{SUPPLIED}.
5. Allow the instrument to achieve a prolonged, stable measurement response and note down the NH₃ reading as shown on the instrument. Label this measurement as [NH₃]_{MEASURED}.
6. Use the noted measurements to calculate the converter efficiency using Equation 6.
7. If the converter efficiency is 80% or greater, the converter is working well, return the converter efficiency to the original value. Adjustments to the converter efficiency value should only be made based on a multipoint check (refer to Section 5.8.2). If the converter efficiency is outside of this range, the test has failed and a multipoint converter efficiency adjustment should be performed.

5.8.2 Multipoint NH₃ Converter Efficiency Adjustment

A multipoint converter efficiency check is performed to determine the actual converter efficiency across the range of the instrument. Thus allowing the user to calculate a new converter efficiency value that can be adjusted in the instrument.

In the S44, the **Conv. Efficiency NH3** value displayed in the **Main Menu** → **Service Menu** → **Calculation Factors Menu** encompasses losses from the external converter, the in-line NH₃ scrubber and the second NO₂ to NO converter coil.

Note: For the following, the results for the NO and NO₂ and NO_x channels can be ignored.

Equipment Required

- Gas Dilution Calibrator (such as a Serinus Cal 1000/2000/3000).
- NH₃ gas cylinder reference standard.
- Zero Air Generator.

Procedure

1. Open - **Main Menu** → **Calibration Menu**.
2. Note down the current value for **Conv. Efficiency NH3**.
3. Edit - **Conv. Efficiency NH3** - (change to 100%) - Accept.
4. Supply the instrument with zero air from your gas dilution calibrator.
5. Allow the instrument to achieve a prolonged, stable measurement response and note down the NH₃ value for reference only. If you get greater than 3 to 5 ppb you need to troubleshoot the instrument and calibration system before continuing with this procedure.
6. Supply the instrument with a known concentration of NH₃ span gas at roughly 80% of the full-scale monitoring range of the particular instrument. Label this value as [NH₃]_{SUPPLIED}.

7. Allow the instrument to achieve a prolonged, stable measurement response and note down the NH_3 reading as shown on the instrument. Label this measurement as $[\text{NH}_3]_{\text{MEASURED}}$.
8. Use the noted measurements to calculate the converter efficiency using Equation 6.
9. Repeat steps 6 to 8 for a minimum of two more NH_3 concentrations spread across the measurement range of the instrument.
10. Average the efficiencies. If the calculated result is greater than 80% efficient, the test has passed. Enter the result as the new **Conv. Efficiency NO2**. If the converter efficiency is below 80%, the test has failed. This may indicate a fault with one or more of the components in the N_x flow path. Try repeating the test and make sure there are no issues with your calibration system. Ensure there is no leaks, backpressure or contamination in your calibration system (refer to Section 7).
11. Open - **Main Menu** → **Calibration Menu**.
12. Edit - **Conv. Efficiency NH3** - (enter averaged efficiency result (only if test passed)) - Accept.

Note: It is very difficult to get a reliable source of NH_3 reference gas. Choose your gas supplier with care.

5.9 High Pressure Zero/Span Valve (Option)

If the instrument was ordered with this option, the internal pressurised calibration valves will already be installed within the instrument as either a zero or span calibration source, thus no other internal connections need to be made.

Note: Before using a high pressure span or zero as a source for calibrating the instrument, please check the local regulatory requirements. This is generally only be used as an operational check of the instrument's zero point and single span point (recommended as 80% of full scale).

5.9.1 Single Pressurised Calibration Option

Set-Up of Single Calibration Option

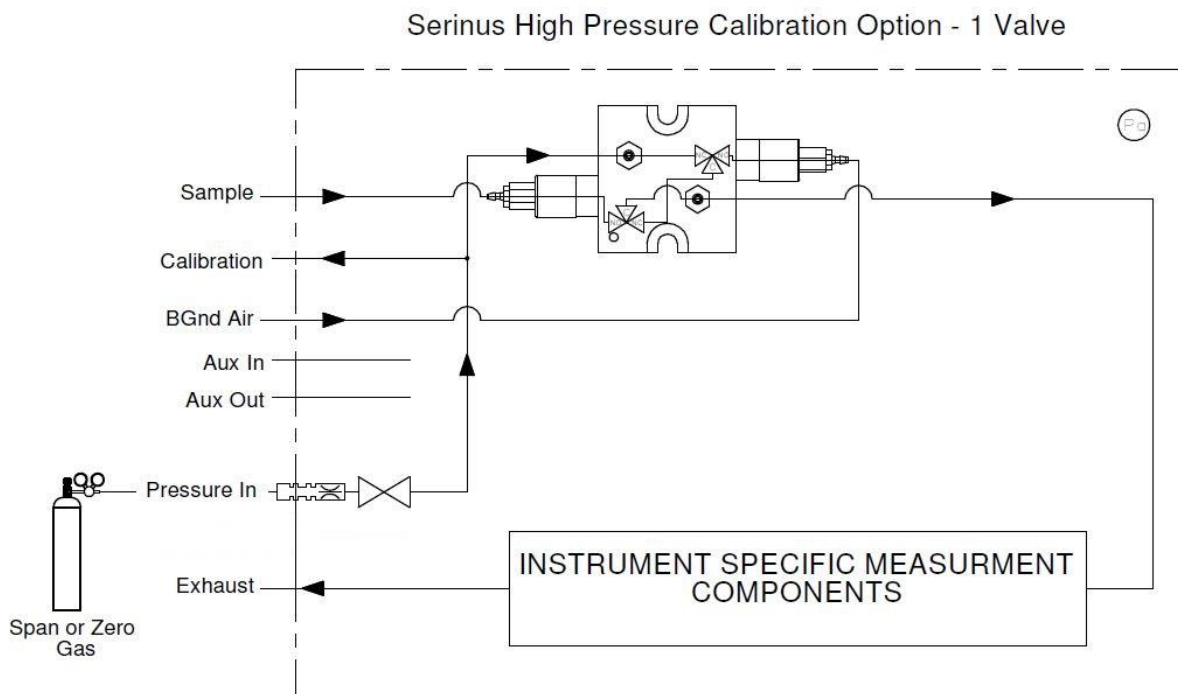

Figure 48 – Single High Pressure Calibration Option

When using the pressurised calibration option, either a high pressure zero or span cylinder (depending on the option you have ordered) should be connected to the **Pressure in Port**.

Equipment Required

- Calibrated Flow Meter
- Gas Cylinder

Procedure

1. Ensure the gas cylinder is fitted with an appropriate gas regulator with a shut off valve.
2. Connect a ¼" line of stainless steel tubing between the gas cylinder and the instruments **Pressure in Port**.

Note: This connection may need to be retightened during this operation.

3. Open the cylinder main valve and adjust the regulator to 15 psig.
4. Open the regulator's shutoff valve and test for leaks:
 - a. Pressurise the line.
 - b. Close the cylinder main valve.
 - c. If pressure drops by more than 2 PSI over five minutes, check the connections and retest.
 - d. Open cylinder main valve.
5. Temporarily place a flow meter on the **Calibration Port** (this port is now used as the high pressure calibration vent).
6. Open - **Main Menu** → **Calibration Menu**.
7. Select - **Cal. Type** → **Manual** - Accept.
8. Select - **Cal. Mode** → **Span** or **Zero** - Accept (depending on the option installed).

Note: When using the high pressure zero option, ensure **Zero Source** is set to **External**.

9. Adjust the regulator pressure until the flow meter on the vent line (**Calibration Port**) is between 0.5 and 1 slpm. This flow rate is you excess calibration gas.

Note: Do not exceed a pressure of 2 bars, this can damage the instrument and cause gas leakage.

Return to Normal Operation

10. Select - **Cal. Mode** → **Measure** - Accept. (To return to sample measure).
11. Remove the flow meter on the **Calibration Port** and connect a vent line.
12. Reconnect the instrument fittings and return to the original set-up.

The instrument is now in normal operation mode. When either zero or span calibration is initiated (depending on which option has been installed) the instrument will automatically open the valves to run a pressurised calibration.

5.9.2 Dual Pressurised Calibration Option

Set-Up of Dual Calibration Option

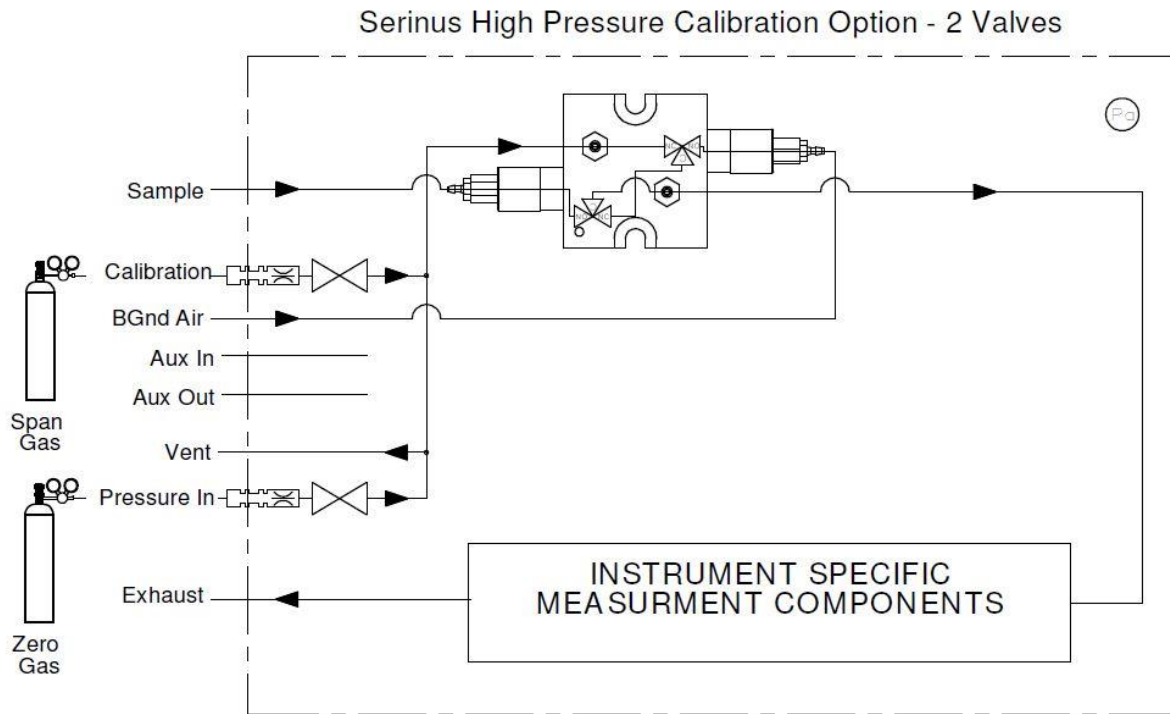

Figure 49 – Dual High Pressure Calibration Option

When using the dual pressurised calibration option, a high pressure zero cylinder should be connected to the **Pressure in Port** and a high pressure span cylinder connected to the **Calibration Port**.

Equipment Required

- Calibrated Flow Meter
- Gas Cylinder of Zero air
- Gas Cylinder of NO

Procedure

1. Ensure the gas cylinder is fitted with an appropriate gas regulator with a shut off valve.
2. Connect a ¼" line of stainless steel tubing between the appropriate gas cylinders and the instrument's **Pressure in Port** and **Calibration Port**.

Note: This connection may need to be retightened during this operation.

3. Open the cylinder main valve and adjust the regulator to 15 psig.
4. Open the regulator's shutoff valve and test for leaks:

- a. Pressurise the line.
 - b. Close the cylinder main valve.
 - c. If pressure drops by more than 2 PSI over five minutes, check the connections and retest.
 - d. Open cylinder main valve.
5. Temporarily place a flow meter on the **Vent Port** (This port is now used as the high pressure calibration vent for both span and zero).
 6. Open - **Main Menu** → **Calibration Menu**.
 7. Select - **Cal. Type** → **Manual** - Accept.
 8. Select - **Cal. Mode** → **Zero** - Accept.

Note: When using the high pressure zero option, ensure **Zero Source** is set to **External**.

9. Adjust the regulator pressure until the flow meter on the vent line (**Vent Port**) is between 0.5 and 1 slpm. This flow rate is you excess calibration gas.

Note: Do not exceed a pressure of two bars, this can damage the instrument and cause gas leakage.

10. Select - **Cal. Mode** → **Span** - Accept.
11. Adjust the regulator pressure until the flow meter on the vent line (**Vent Port**) is between 0.5 and 1 slpm. This flow rate is you excess calibration gas.

Note: Do not exceed a pressure of two bars, this can damage the instrument and cause gas leakage.

Return to Normal Operation

12. Select - **Cal. Mode** → **Measure** - Accept. (To return to sample measure).
13. Remove the flow meter on the **Vent Port** and connect a vent line.
14. Reconnect the instrument fittings and return to the original set-up.

The instrument is now in normal operation mode. When either zero or span calibration is initiated the instrument will automatically open the valves to run a pressurised calibration.

This page is intentionally blank

6. Service

6.1 Maintenance Tools

To perform general maintenance on the Serinus 44 you may require the following equipment:

- Customizable Test Equipment Case PN: H070301
- Digital Multimeter & Leads (DMM) PN: E031081 & E031082
- Barometer PN: E031080
- Thermometer & Probe PN: E031078 & E031079
- Flow Meter (Select Range)
 - Range: 50 sccm to 5000 sccm PN: ZBI-200-220M
 - Range: 300 sccm to 30000 sccm PN: ZBI-200-220H
- Minifit Extraction Tool PN: T030001
- Orifice/Sintered Filter Extraction Tool PN: H010046
- Leak Test Jig PN: H050069
- Computer/Laptop and Connection Cable for Diagnostic Tests
- 1.5mm hex key
- Assortment of 1/4" and 1/8" Tubing and Fittings
- Zero Air Source
- Span Gas Source



Figure 50 – Minifit Extraction Tool – (T030001)

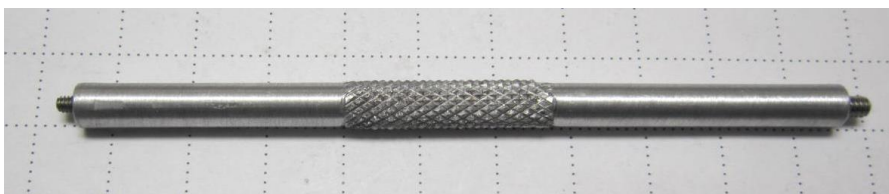

Figure 51 – Orifice/Sintered Filter Removal Tool – (H010046)

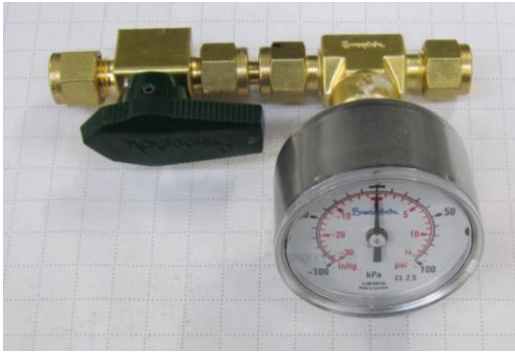

Figure 52 – Leak Test Jig – (H050069)



Figure 53 – Air Monitoring Test Equipment Kit (AMTEK) - Customisable

6.2 Maintenance and Calibration Schedule

The maintenance intervals are determined by compliance standards that differ in various regions. The following is recommended by Ecotech as a guide. Compliance with local regulatory or international standards is the responsibility of the user.

Table 6 – Maintenance Schedule

Interval *	Task Performed	Section
Nightly or Every 5 days	Perform precision check (Automated) Perform precision check (Manual) (This task is performed to ensure a high data capture rate)	5.5

Monthly	Perform precision check (pre-check) prior to commencing any service tasks or making any changes to the system as found in its current state. This task is necessary to validate any previously captured data.	5.5
	Check particulate filter, replace if full/dirty	6.3.1
	Perform a pressure check	6.3.9
	Check sample inlet system for moisture or foreign materials. Clean if necessary	
	Check fan filter and clean if necessary	6.3.2
	Check event log	3.4.1
	Check date and time is correct	3.4.8
	Check instrument status light	3.3.1
	External vacuum pump check (vacuum source) Cell Pressure of 50 to 200 torr is a good vacuum	
	leak check	6.3.5
	Perform NO _x span calibration	5.4
	Perform precision check (post-check) once all service tasks have been completed. This task is necessary to establish a valid start point to begin capturing new data.	5.5
3 Monthly	Single point NO ₂ converter efficiency check	5.7.1
	Single point NH ₃ converter efficiency check	5.8.1
6 Monthly	Replace the PMT Desiccant Packs	6.3.6
	Perform multipoint precision check	5.6
	Calibrate analog outputs (only if used)	
Yearly	Replace DFU filter	6.3.3
	Replace sintered filter and orifice (only if necessary)	
	Clean reaction cell	6.3.7
	Replace NH ₃ Scrubbers	6.3.4
	Multipoint NO ₂ to NO converter efficiency adjust	5.7.2
	Multipoint NH ₃ converter efficiency adjust	5.8.2

* Suggested intervals for maintenance procedure are a guide only and may vary with sampling intensity and/or environmental conditions. Please refer to your local regulatory standard for your personalised maintenance schedule.

6.3 Maintenance Procedures

6.3.1 Particulate Filter Replacement

Contamination of the filters can result in degraded performance of the instrument, including slow response time, erroneous readings, temperature drift, and various other problems.

1. Turn off the external pump and allow the analyser to return to ambient.
2. Slide open the lid of the instrument to access the particulate filters (located in front right hand corner).
3. Unscrew each filter cap (bright blue) by turning them counter-clockwise.
4. Remove the filter plunger from the casing, place finger on tubing connector and pull to the side (refer to Figure 54).

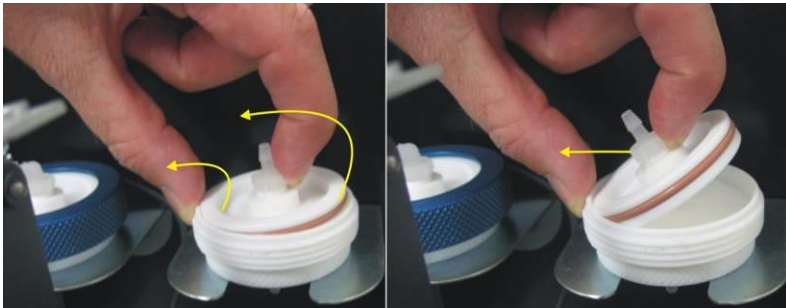

Figure 54 – Removing Plunger

5. Remove the old filter paper, wipe down the plunger with a damp cloth and insert a new filter.
6. Replace the plunger, screw on the filter cap.
7. Close the instrument and perform a leak check (refer to Section 6.3.5).

6.3.2 Clean Fan Filter

The fan filter is located on the rear of the instrument. If this filter becomes contaminated with dust and dirt it may affect the cooling capacity of the instrument.

1. Remove outer filter casing and filter (refer to Figure 55).
2. Clean filter with water and wring dry or shake vigorously.
3. Reinstall filter and filter casing.



Figure 55 – Removing the Fan Filter

6.3.3 DFU Replacement

Equipment Required

- 5/8" Spanner

Procedure

1. Turn off the external pump and allow the analyser to return to ambient.
2. Loosen the Kynar nuts from both ends of the DFU.
3. Remove and replace the DFU (refer to Figure 56 right hand side of the DFU in the image should connect to the dryer) and tighten the Kynar nuts.



Figure 56 – DFU Filter

6.3.4 NH₃ Scrubber Replacement

Equipment Required

- 5/8" Spanner

Procedure

1. Disconnect the external pump.
2. Locate the two scrubbers inside the instrument. Undo the Kynar nuts at both ends of each scrubber and remove the scrubbers.
3. Remove the Kynar nuts on both ends of each new replacement NH₃ scrubber and install them into the instrument using the existing nuts.



Figure 57 – NH3 Scrubber

6.3.5 Leak Check

Equipment Required

- Source of Vacuum (pump)
- Leak Test Jig (PN: H050069)
- Kynar ¼" Blocker Nuts
- Tubing and Assorted Fittings
- 5/8" Spanner
- 9/16" Spanner

Procedure

Note: Ensure that the instrument has been running for at least one hour before this procedure is performed.

1. Disconnect all external tubing connected to the rear ports of the instrument except for the **AUX in Port** and **AUX Out Port** (for the external converter).
2. Connect a leak check jig to the Exhaust Port of the instrument.
3. Connect a vacuum source to the shut off valve end of the leak test jig ensuring the shut off valve is in the open position.
4. Open - **Main Menu** → **Service Menu**.
5. Select - **Ozone Gen. Control** → **Off**.
6. Allow the instrument two minutes to purge the O3 from the pneumatic system.
7. Open - **Main Menu** → **Service Menu** → **Diagnostics Menu** → **Valve Menu**.
8. Disable - **Valve Sequencing** → **Disabled**.
9. Turn **Off** all the valves except the **Sample/Cal** valve.
10. Block the **BGnd Air Port**.
11. Allow the instrument time to evacuate the pneumatic system (the time required will depend on the vacuum source used).
12. Close the shut off valve and record the vacuum. Wait for three minutes and observe the gauge on the leak check jig. It should not drop more than 5 kpa (37.5 torr). If the leak check passed skip to step 15.

13. Inspect the instrument's plumbing looking for obvious damage. Check the condition of fittings, particulate filter housing plus the O rings both in the filter assembly and in the cell assembly.
14. If the leak is still present divide up the pneumatic system into discrete sections to locate the leak (refer to Section 9.5). When the location of the leak has been determined repair and then rerun the leak check procedure.
15. Open - **Main Menu → Service Menu → Diagnostics Menu → Valve Menu.**
16. Toggle Off – **Sample/Cal → Off** (this is done to release the vacuum safely)
17. Allow one minute for the system to equalise even when your gauge is back at ambient (residual vacuum will still be in sections of the system. Remove the blocker on the **BGnd Air Port** and Inspect the internal tubing to ensuring that the tubing is cleanly connected to the fittings and that the internal Teflon lining has not been kinked or crumpled.
18. Remove the leak check jig.
19. Enable - **Valve Sequencing → Enabled.**

6.3.6 Replacing the PMT Desiccant Pack

The PMT housing contains two desiccant packs to prevent condensation on the PMT cold block housing. If the desiccant expires it will result in corrosion and premature cooler failure. It is recommended that the desiccant bags be changed at least annually. If moisture is detected inside the housing or the desiccant packs are saturated the interval should be reduced. To change the desiccant packs follow the instructions below:



CAUTION

Because the PMT is extremely sensitive to light, it is essential that before opening the PMT assembly to make sure that the instrument is switched off.

Once the instrument is switched off it is very important to cover the PMT at all times so that no direct light reaches its window.

Equipment Required

- Phillips Head Screwdriver
- New Desiccant Packs
- Tweezers

Procedure

1. Turn the instrument off and disconnect the power. Wait 15 min for the cold block to warm up.
2. Using a Phillips head screwdriver, remove the desiccant pack access cap from the PMT housing.

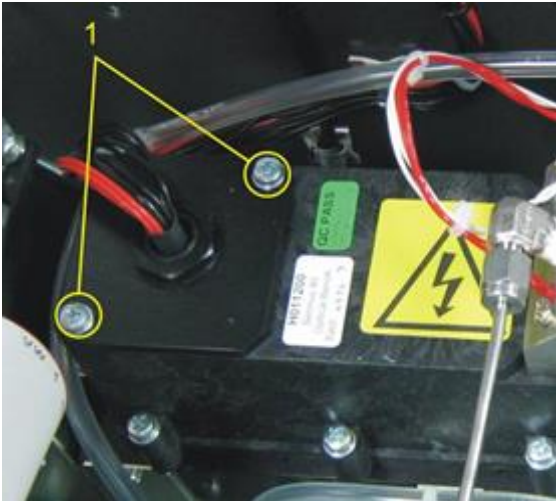

Figure 58 – Removing the Desiccant Pack

3. Remove the old desiccant packs and replace with new ones. Do not attempt to dry and reuse the old packs.
4. Inspect the inside of the PMT housing (by touch or with an inspection mirror) to check for moisture inside the housing. If moisture is detected inside the housing or the desiccant packs are saturated, the desiccant packs should be replaced more frequently.
5. Reinstall the desiccant cap by gently twisting and pressing the cap back into the PMT housing. It may help to apply a small amount of lubricant to the O-ring on the desiccant cap. Secure with two screws.



CAUTION

Do not attempt to use the fastening screws to push the desiccant cap in place in the PMT housing. This will damage the O-ring.

6. Reconnect power and restart the instrument.

6.3.7 Cleaning the Reaction Cell

As O₃ reacts with the contaminants in the air it will begin to deposit a film on the walls and optical filter within the cell. This will result in decreased sensitivity of the instrument and increase the instrument gain required to take readings. The reaction cell should be cleaned periodically to remove deposits and restore sensitivity.



CAUTION

Take extreme care not to damage the pressure transducer assembly on top of the reaction cell.

Equipment Required

- Phillips Head Screwdriver
- Black Electrical Tape
- Sonic Bath or Alternatively Isopropanol Alcohol
- Clean Dry Oil Free Compressed Air

- Oven or Heat Gun
- Spare Parts or Annual Maintenance Kit

Procedure

1. Prepare and cut three pieces of black electrical tape approximately 5cm in length and layer them approximately 3cm wide. Keep these near your work area as we will use this immediately to protect the PMT as the reaction cell is being removed.
2. Turn the instrument off, Wait fifteen minutes for the cold block on the optical cell to warm up to prevent condensation.
3. While the cold block is warming up allow the vacuum pump to purge the instrument for five minutes then turn off the vacuum pump and allow the instrument to return to ambient.



CAUTION

Because the PMT is extremely sensitive to light, it is essential that before opening the PMT assembly to make sure that the instrument is switched off. Once the instrument is switched off it is very important to cover the PMT at all times so that no direct light reaches its window.

4. Disconnect the electrical and pneumatic fittings from the reaction cell, remove the four screws that secure the reaction cell to the optical cell and remove the assembly.

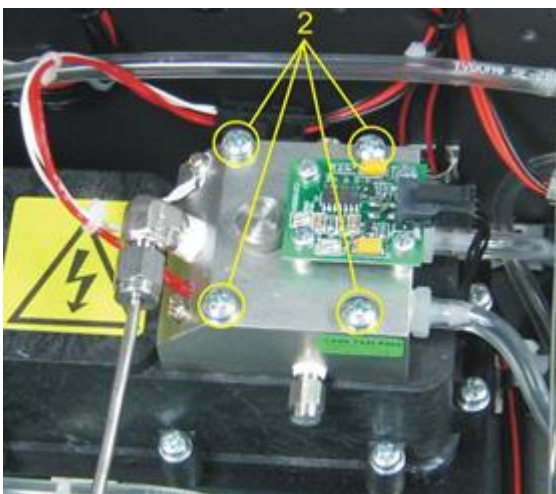

Figure 59 – Remove Reaction Cell

5. Cover the PMT window on the optical cell (under the reaction cell) with the black electrical tape immediately.
6. Turn the reaction cell upside down and remove the four screws fastening the optical filter from the cell (refer to Figure 60).

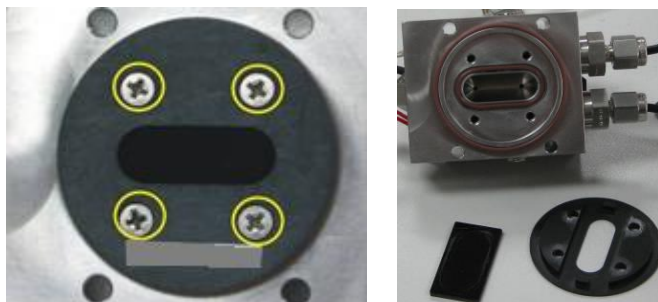

Figure 60 – Optical Filter Removal and Cleaning

7. Clean the filter with a lint free tissue with distilled water if further cleaning is required use high purity isopropyl alcohol.
8. Dismantle the reaction cell and clean all the stainless steel parts with high purity isopropyl alcohol. Then wash in an ultra-sonic bath with lab detergent and water.
9. Blow out all the liquid with clean oil free compressed air and dry by gently heating the assembly.
10. Reassemble the reaction cell, replacing the 3 sintered filters (refer to Section 9.7) and test for leaks.
11. Remove the black electrical tape from the optical cell while replacing the reaction cell immediately.
12. Perform a full system leak test.
13. Run a span point and calibrate the instrument.

6.3.8 Clean Pneumatics

The calibration valve manifold and auxiliary valve manifold will require disassembling and cleaning. Ideally the valves and the manifolds should be cleaned in a sonic bath with lab detergent and water. Once clean rinse with distilled water and dry before reassembling (refer to Section 9.9 Section 9.10 and Section 9.11). A leak test on each assembly should be performed before adding the assembly back into the system. Once the system has been reassembled the instrument should have a full system leak check (refer to Section 6.3.5).

If the tubing shows signs of significant contamination, it should be replaced with new tubing.

6.3.9 Pressure Sensor Check

Pressure checks are needed to ensure that the pressure sensor is accurately measuring pressure inside the instrument.

During normal operation ensure that the **Pressure & Flow Menu** indicate the following parameters. Ambient should display the current ambient pressure at site. Cell should indicate current cell pressure depending on the pump condition and location. A Cell pressure of between 50 torr and 200 torr is recommended. The manifold pressure is normally about 20 torr below ambient.

Equipment Required

- Barometer
- Digital Multimeter (DMM)

Procedure

1. Open - **Main Menu** → **Analyser State Menu** → **Pressure & Flow Menu**.
2. Turn off the vacuum pump and allow the analyser to return to ambient.
3. Disconnect all external tubing connected to the rear ports of the instrument except for the **AUX in Port** and **AUX Out Port** (for the external converter).
4. After two-five minutes observe the pressure readings: ambient, cell and manifold. Ensure that they are reading the same ± 3 torr (± 0.4 kPa).
5. If the readings are outside this level, perform a pressure calibration (refer to Section 5.2).

If the calibration fails, the instrument may have a hardware fault. The cell pressure PCA and the manifold pressure PCA have test points. To determine if the pressure sensor is faulty simply measure the voltage on the test points shown in the photos. The voltage measured across the test point is proportional to the pressure measured by the sensor, so if the sensor is exposed to ambient pressure at sea level then the voltage will be around 4 volts but if the sensor is under vacuum the voltage will be low (for example, 0.5 volts). If the test point measures zero or negative voltage the assembly is most likely faulty and will need to be replaced.



Figure 61 – Test Point Location

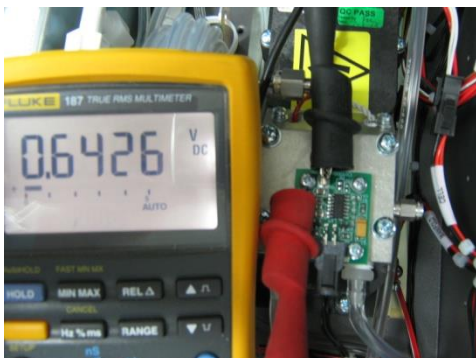

Figure 62 – Typical Test Point Reading of Cell Pressure with Vacuum Connected to Exhaust Port



Figure 63 – Typical Test Point Reading of Manifold Pressure Sensor

6.3.10 Ozone Generator Maintenance

Ozone production in the Serinus 44 is achieved via a corona discharge method. Ambient air is drawn through a DFU and a Nafion dryer into the ozone generator. High levels ($\approx 6,000$ ppm) of ozone are produced.



CAUTION

Risk of electric shock. Do not power assembly during maintenance procedures.

Equipment Required

- Phillips Head Screwdriver
- Ozone Generator Retrofit Kit (PN: H011134)
- Ecotech Tygon Tubing (PN: T010011)

Procedure

1. Turn off the instrument and vacuum pump, allow the analyser to return to ambient.
2. Open the lid and locate the Ozone Generator. Disconnect the Tygon tubing leading into and out of the assembly.
3. Undo the 3 screws (refer to Figure 64) and lift the complete assembly from the instrument while at the same time disconnecting the assemblies power connector underneath from the main loom as you go.

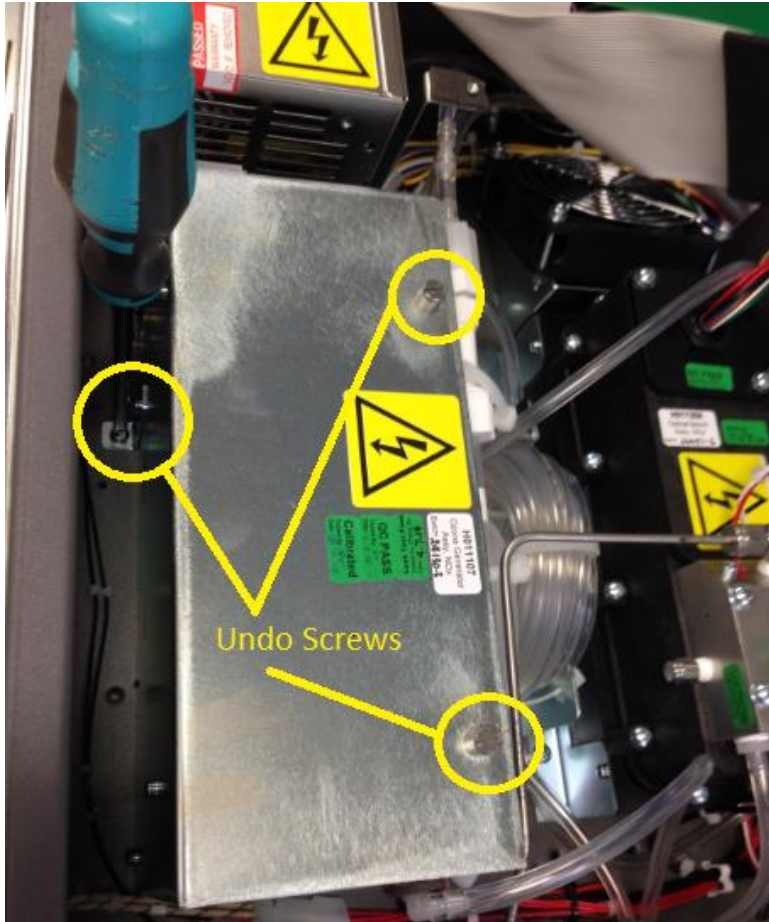

Figure 64 – Remove Ozone Generator from Instrument

4. Inspect the Tygon tubing and replace if damaged or contaminated.
5. The Ozone generator PCA needs to be removed from the metal housing to get access underneath. Disconnect the power connector and undo 4 Phillips screws from the underside of the mounting.

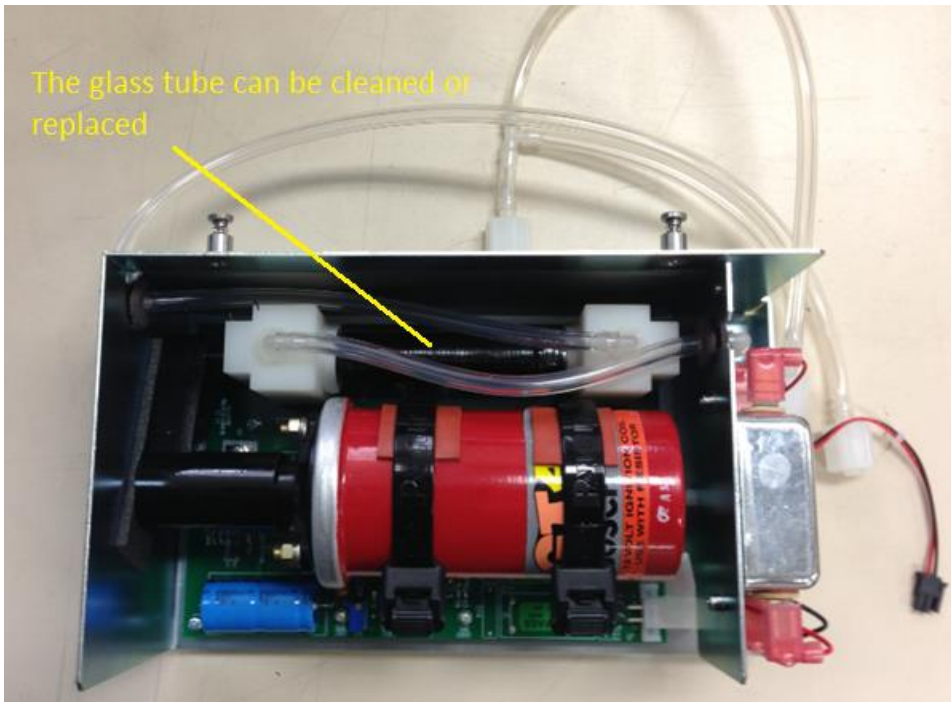

Figure 65 – Cleaning of Glass Tube

6. With the PCA now free locate the white Teflon block fastening screws and disassemble glass tube (refer to Section 9.7).
7. Clean or replace the glass tube and replace the Teflon gaskets.
8. Reassemble in the reverse order.
9. Before installing into the instrument perform a leak check to ensure your ozone generator assembly is not leaking.
10. Install the ozone generator assembly into the instrument. Power up the instrument and vacuum pump and wait for the warm-up sequence to complete.
11. Perform a full system leak check (refer to Section 6.3.5).
12. Perform a zero and span calibration.

6.4 Bootloader

The Serinus Bootloader is the initial set of operations that the instruments' microprocessor performs when first powered up (similar to the BIOS found in a personal computer). This occurs every time the instrument is powered up or during instrument resets. Once the instrument boots up, it will automatically load the instruments' firmware. A service technician may need to enter the Bootloader to perform advanced microprocessor functions as described below.

To enter the Bootloader turn off the power to the instrument. Press and hold the plus key while turning the power on. Hold the Plus key until the following screen appears.

** Ecotech Serinus Analyser **
V3.1 Bootloader

Press '1' to enter Bootloader

If the instrument displays the normal start up screen, the power will need to be toggled and another attempt will need to be made to enter the Bootloader. Once successful, press 1 to enter the **Bootloader Menu**.

6.4.1 Display Help Screen

Once in the Bootloader screen it is possible to redisplay the help screen by pressing 1 on the keypad.

6.4.2 Communications Port Test

This test is very useful for fault finding communication issues. It allows a communication test to be carried out independent to any user settings or firmware revisions.

This command forces the following communication ports to output a string of characters: Serial Port RS232 #1, USB rear and Ethernet Port. The default baud rate is 38400 for the RS232 Serial Port. To initiate the test press the number 2 key from the Bootloader screen.

6.4.3 Updating Firmware

It is important for optimal performance of the instrument that the latest firmware is loaded. The latest firmware can be obtained by visiting Ecotech's website:

<http://www.ecotech.com/downloads/firmware>

Or by emailing Ecotech at service@ecotech.com or support@ecotech.com

To update the firmware from a USB memory stick, use the following procedure:

USB Memory Stick Update

1. Turn the instrument off.
2. Place the USB memory stick with the new firmware (ensure that firmware is placed in a folder called FIRMWARE) in the front panel USB Port.
3. Enter the Bootloader (refer to Section 6.4).
4. Select option 3 (upgrade from USB memory stick), press 3 on the keypad.
5. Wait until the upgrade has completed.
6. Press 9 on the keypad to start the instrument with new firmware.

6.4.4 Erase All Settings

This command is only required if the instrument's firmware has become unstable due to corrupted settings. To execute this command enter the **Bootloader Menu** (refer to Section 6.4) and press 4 on the keypad.

6.4.5 Start Analyser

The start analyser command will simply initiate a firmware load by pressing 9 on the keypad from the **Bootloader Menu**. It is generally used after a firmware upgrade.

This page is intentionally blank.

7. Troubleshooting

Table 7 – Troubleshoot List

Error Message/Problem	Cause	Solution
Flow fault	Multiple possibilities	Refer to Section 7.1.
Noisy/unstable readings	Multiple possibilities	Refer to Section 7.2.
	Calibration system error	Ensure calibration system is functioning correctly and is leak free. Ensure sufficient gas is available for instrument and an adequate vent is available for excess gas.
	Leaks	A leak in the instrument or calibration system dilutes the sample stream and causes low span readings and noise.
	TE cooler, reaction cell heater or converter heater	A failed temperature control allows the instrument to drift with ambient temperature. Verify that the cell temperature is 50°C ±3°C and that the TE cooler is 13°C ±2°C and that the converter temperature is 325°C ±5°C.
	Hardware fault	Faulty optical bench component.
	Instrument Gain too high	1. Leak check (repair any leaks). 2. Background Port flow too high >130cc/min. Service instrument. 3. PMT voltage too low less than 640V. 4 Optical filter in reaction cell contaminated requires cleaning.
	Cell pressure too high (>280 torr)	1. Leak check (repair any leaks). 2. Replace external pump. 3. Background Port flow too high >130cc/min. Service instrument. 4. Recalibrate pressure sensors.
	PMT temperature too high (>15°C)	1. Check optical bench heat sink fan is operating. 2. Check PMT cooler is operational, and correct amount of thermal paste is applied.
Unstable ozone generator	Ensure Ozone Generator is on in the service menu. If the generator will not turn on check converter temperature and vacuum readings. Once the ozone generator is on check that 12 volts is supplied to the generator connector. If 12 volts are being supplied to the generator try substitute ozone generator with known working generator. If the instrument now works replace ozone generator.	
Converter temp failure	Faulty heater or temperature sensor	Refer to Section 7.3.

Error Message/Problem	Cause	Solution
Flow block temp failure	Faulty heater or temperature sensor	Refer to Section 7.4.
Reaction cell temp failure	Faulty heater or temperature sensor	Refer to Section 7.5.
Instrument resetting	Multiple possibilities	<ol style="list-style-type: none"> 1. Check that the instrument is not overheating. 2. Possibly a faulty power supply. 3. Corrupted firmware. Perform 'erase all settings' in the Bootloader Menu and reload or upgrade firmware.
12 Voltage supply failure	Power supply has failed	Replace power supply.
No display	AC power	Verify that the mains power cable is connected and the rear fan is operating
	Contrast misadjusted	Adjust the display contrast by pressing two keys on the front panel: <ul style="list-style-type: none"> ▪ Press up arrow (▲) for darker contrast ▪ Press down arrow (▼) for lighter contrast
	DC power	Verify that the power supply is providing $\pm 12V +5V$ DC. TP40, TP23 and TP41
	Display	Check the interface cable between the display and the microprocessor board.
	Bad display or microprocessor PCA	<ol style="list-style-type: none"> 1. Replace the front panel display. 2. Replace the microprocessor board. 3. A bad cable is unlikely, but if you suspect it, perform a pin-for-pin continuity test using an ohmmeter.
Sample pressure too high or too low	Loss of pressure calibration	Ensure particulate filter has been recently changed. Ensure tubing is not kinked or blocked. Ensure vacuum pump is correctly installed and operating. Perform a pressure calibration (refer to section 5.2).
Sample flow not at 0.9 SLPM	Multiple possibilities	<ul style="list-style-type: none"> ▪ Check/replace sample filter. ▪ Check pump. ▪ Check valves. ▪ Check/replace sintered filter. ▪ Re-calibrate pressure sensors.
Unstable flow or pressure readings	Faulty pressure sensors	Check pressure transducer calibration. Check calibration valve block is functioning and not blocked. If unable to diagnose problem check voltage across TP1 and TP2 of manifold pressure PCA ensure it is about 4 volts ± 0.5 volts. Check voltage across TP1 and TP2 of cell pressure PCA (with vacuum connected) ensure it is about 1 volts ± 0.5 volts. If unable to diagnose problem, it may be a noisy A/D converter, replace main controller PCA.

Error Message/Problem	Cause	Solution
Low span	Leaks	A leak in the instrument or calibration system dilutes the sample stream and causes low span readings and noise.
	Span calibration out	Adjust the span using the calibration procedure.
No response to span gas	Leaks/blockages	Leaks or blockages in tubes or valves. Perform leak check and flow check and repair any leaks/blockages.
	Faulty calibration source	Ensure calibration gas is plumbed correctly, is not contaminated, has no leaks and is a certified reference gas.
	Hardware fault	Faulty optical bench or ozone generator.
Zero drift	Not enough zero air supplied	Check calibrator excess flow is sufficient.
	Faulty zero air	Ensure zero air sources are not overly polluted.
	Leak	Perform leak test.
Lower than expected NO _x and NO ₂	NH ₃ scrubber, NO ₂ converter	Preform a NO ₂ converter efficiency test (refer to Section 5.7).
Lower than expected N _x and NH ₃	NH ₃ converter, NH ₃ selective scrubber, NO ₂ converter	Preform a NH ₃ converter efficiency test (refer to Section 5.8).

7.1 Flow Fault

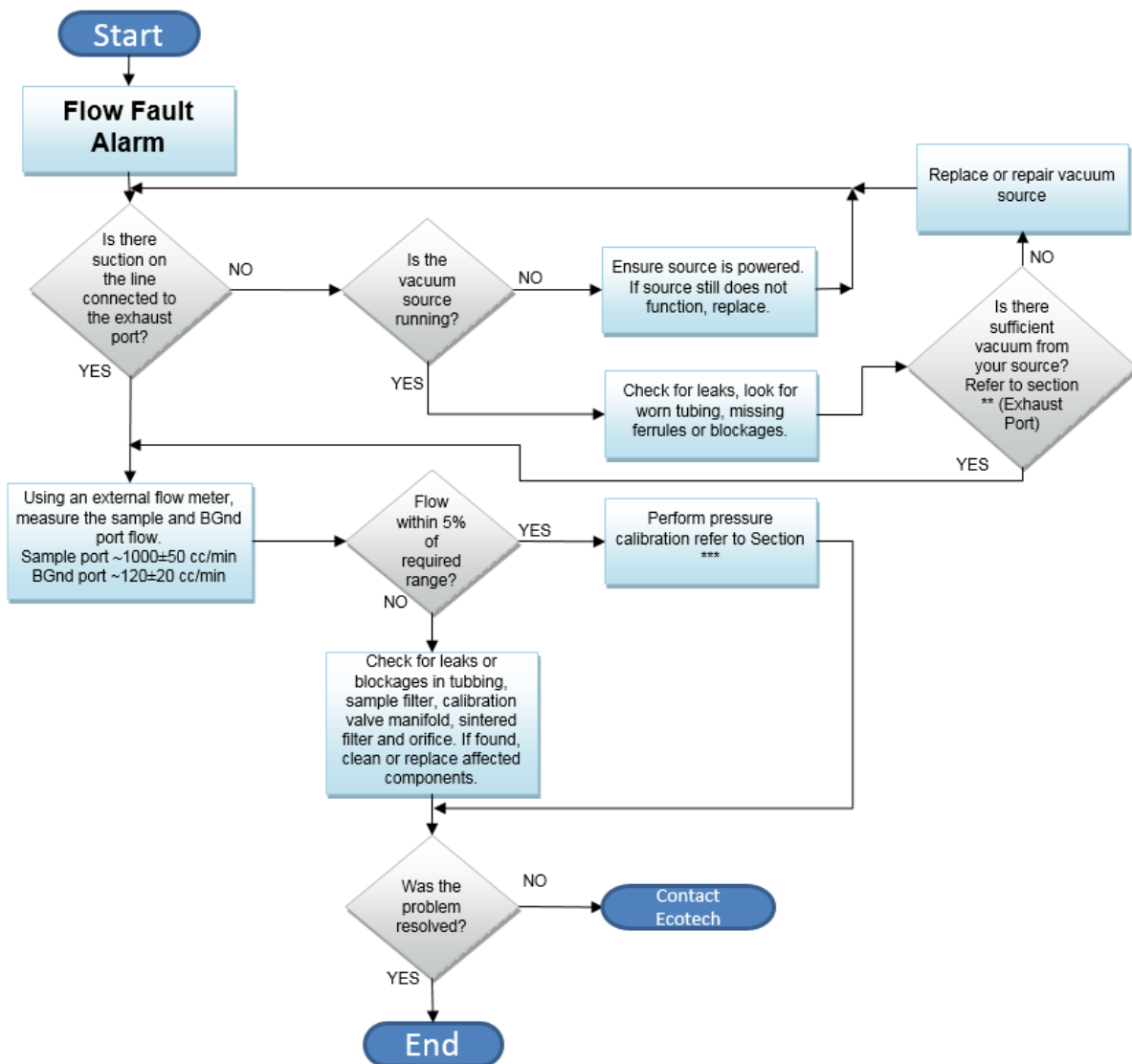

Figure 66 – Zero Flow Fault Troubleshooting Flow Chart

** Section 2.3.1

*** Section 5.2

7.2 Noisy/Unstable Readings

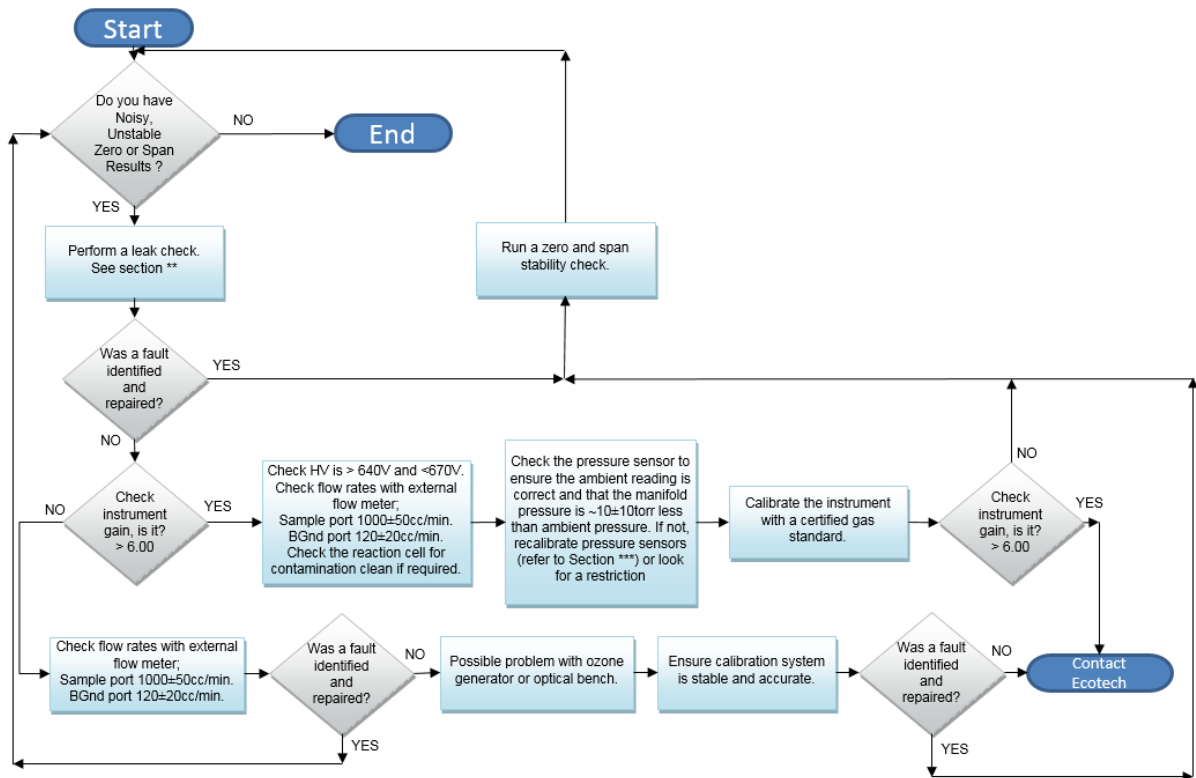

Figure 67 – Noisy or Unstable Readings Troubleshooting Flow Chart

** Section 6.3.5

*** Section 5.2

7.3 Converter Temperature Failure

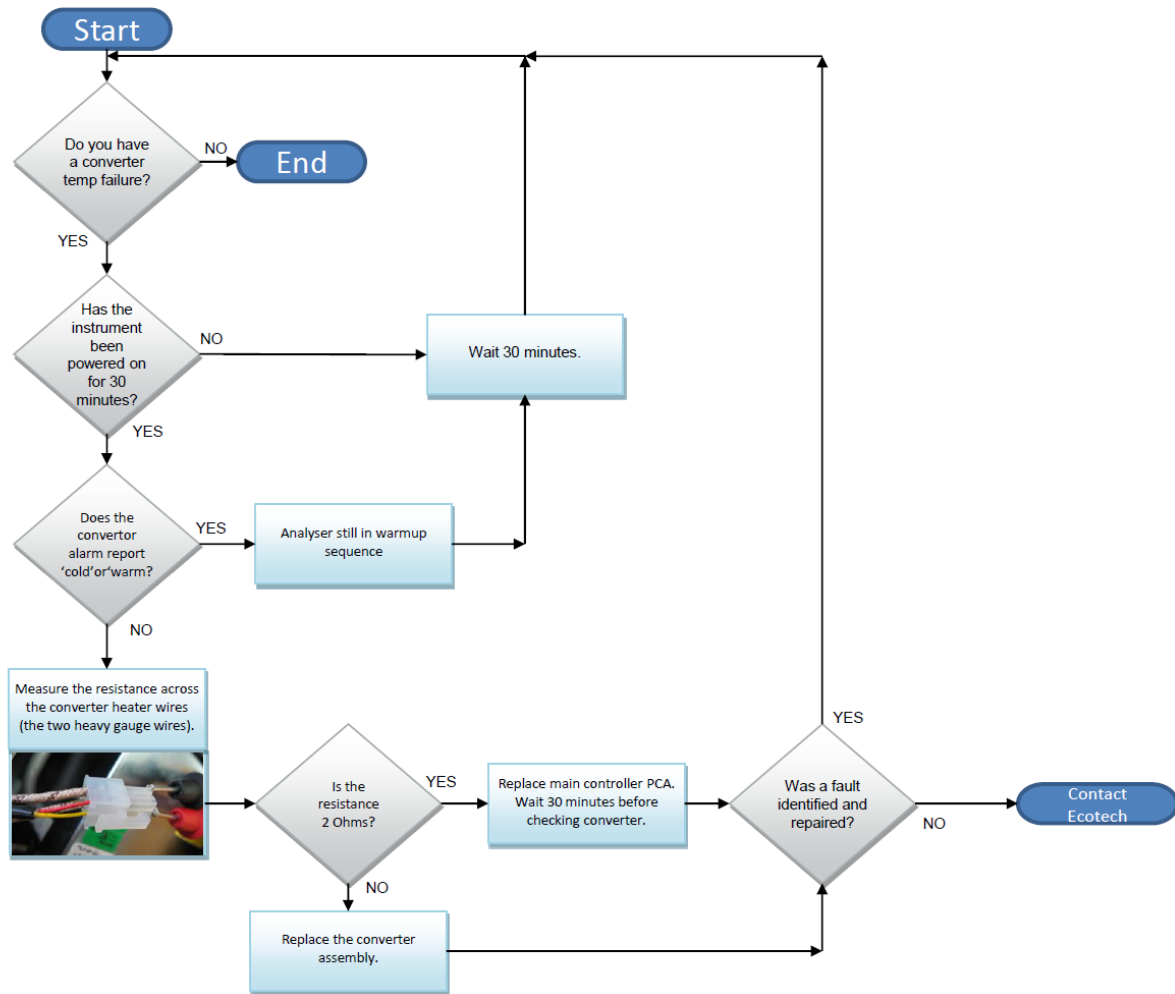

Figure 68 – Converter Alarm Troubleshooting Flow Chart

7.4 Flow Block Temperature Failure

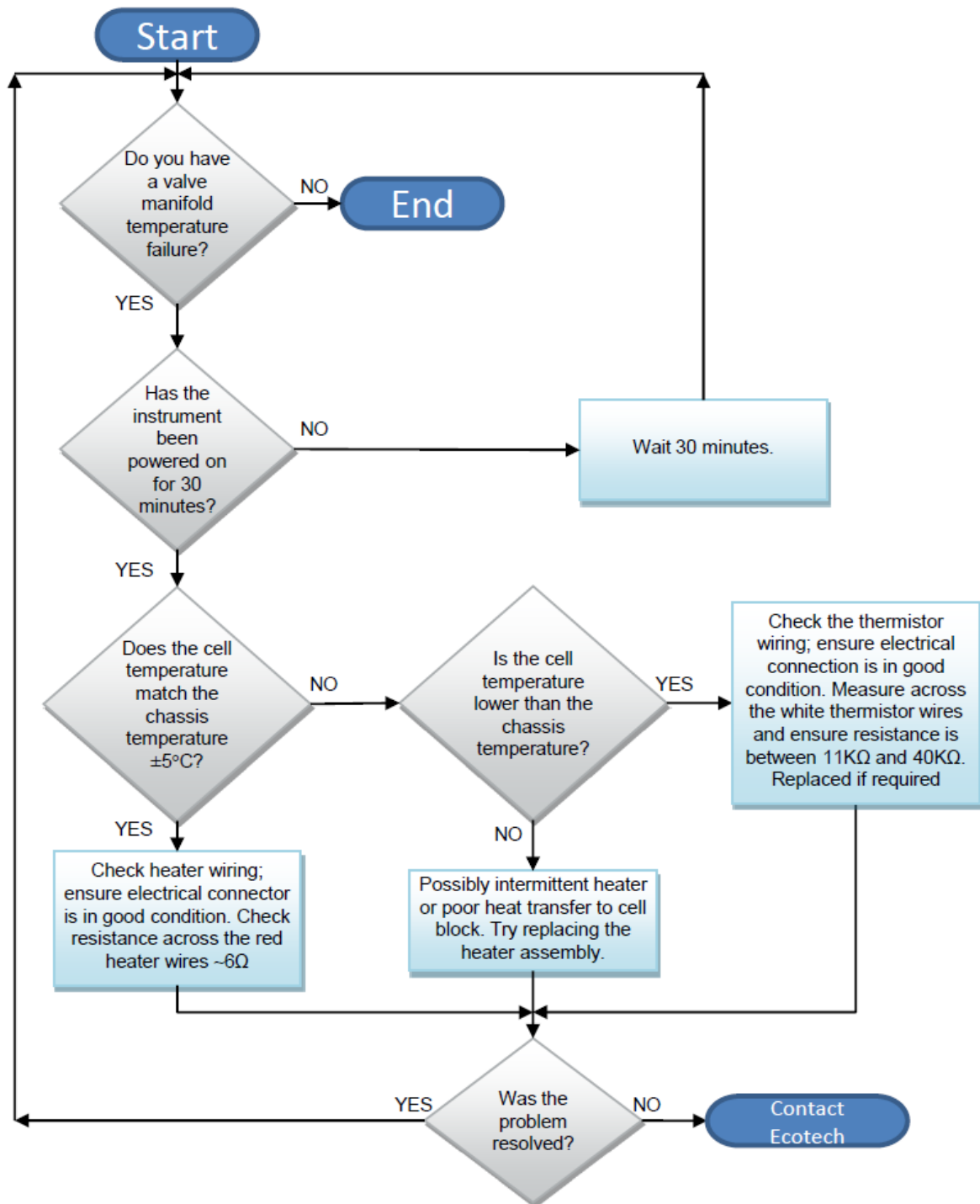

Figure 69 – Valve Manifold Temperature Alarm Troubleshooting Flowchart

7.5 Reaction Cell Temperature Failure

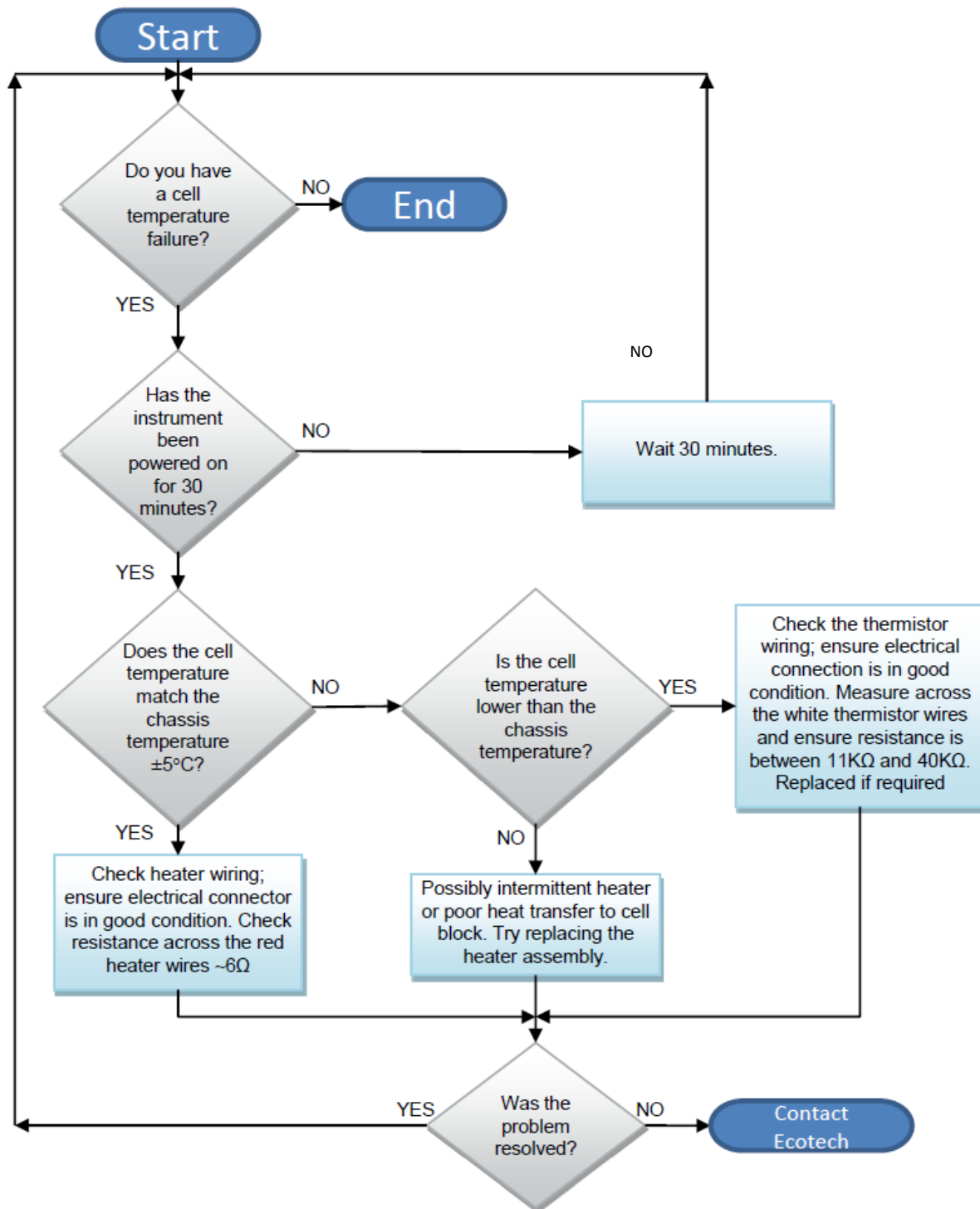

Figure 70 – Reaction Cell Temperature Failure Troubleshooting Flow Chart

7.6 USB Memory Stick Failure

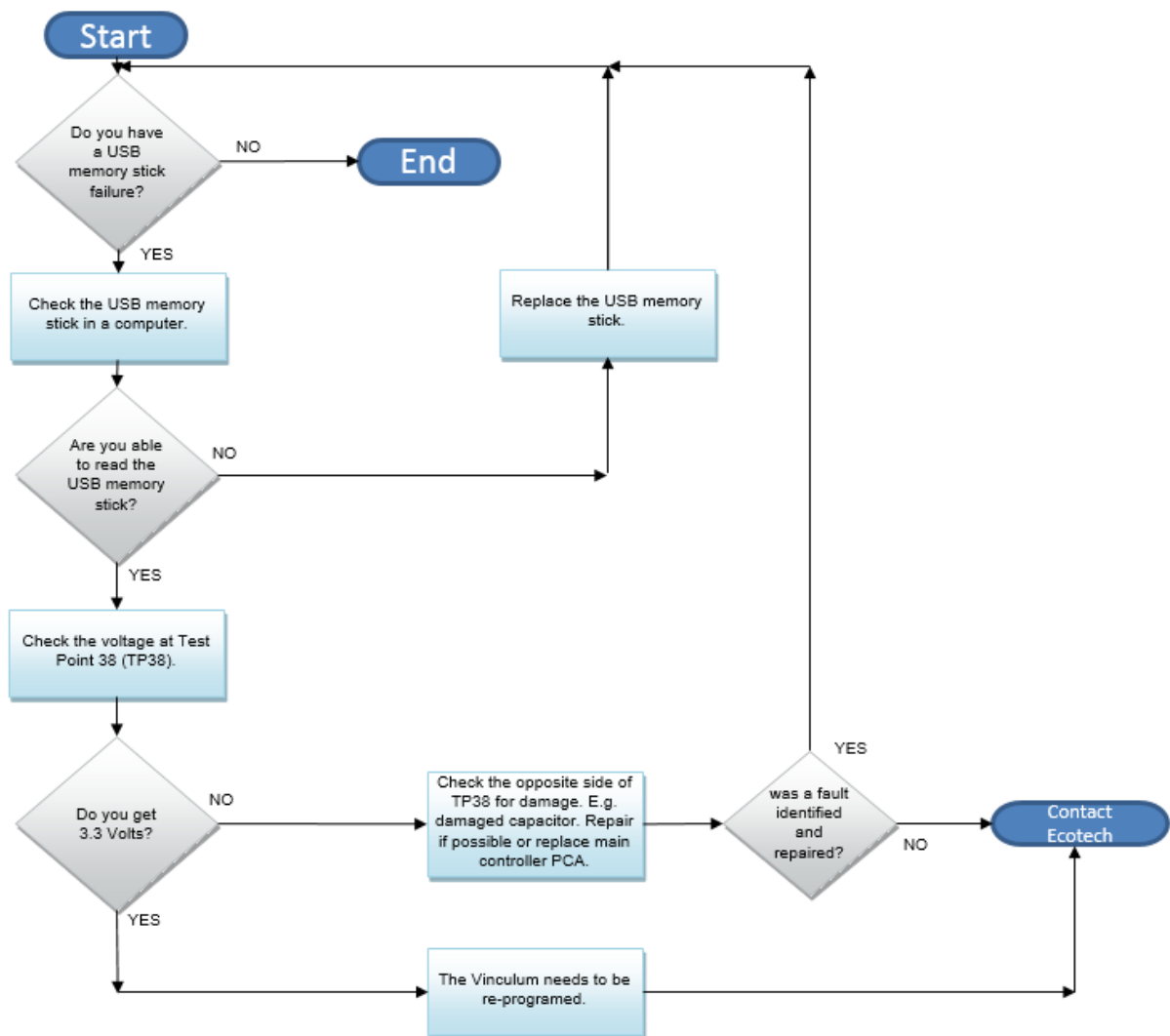

Figure 71 – USB Memory Stick Failure

7.7 Ecotech Service Support Files

Regular backup of the settings, parameters and data on the instruments USB memory stick is recommended.

In the event of a fault that requires Ecotech technical support, please make copies of the following files and email to: support@ecotech.com

Equipment Required

- PC/Laptop

Procedure

State the ID number, variant, board revision and firmware version of the instrument with a brief description of the problem. Take a copy of the current configuration if possible and a save of the parameters.

1. Open - **Main Menu** → **Analyser State Menu**.
2. **Variant** - (take note).
3. **Ecotech ID** - (take note).
4. **Board Revision** - (take note).
5. **Firmware Ver.** - (take note).
6. Open - **Main Menu** → **Service Menu**.
7. Save - **Save Configuration** - (CONFIG**.CFG) - Accept.

Note: CONFIG99.CFG is the “Factory Backup” file, this is the configuration of the instrument as it left the factory. It is recommended that this file is kept unchanged but can be used as a reference backup point.

** Can be any number from 0 – 98.

8. Save - **Save Parameter List** - (PARAM**.TXT) - Accept.
9. Eject - **Safely Remove USB Stick** - (Follow instructions).

Note: PARAM99.TXT is the “Factory Backup” file, This is a snap shot of the parameters while it was under test in the factory just prior to release. It is recommended that this file is kept unchanged but can be viewed for reference.

** Can be any number from 0 – 98.

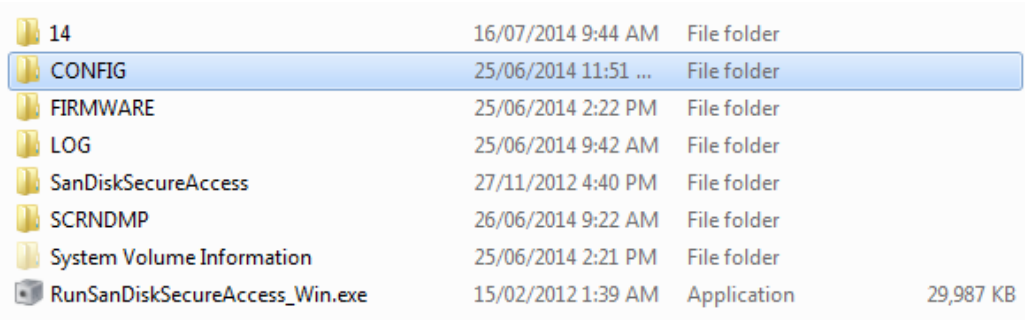

14	16/07/2014 9:44 AM	File folder	
CONFIG	25/06/2014 11:51 ...	File folder	
FIRMWARE	25/06/2014 2:22 PM	File folder	
LOG	25/06/2014 9:42 AM	File folder	
SanDiskSecureAccess	27/11/2012 4:40 PM	File folder	
SCRNDMP	26/06/2014 9:22 AM	File folder	
System Volume Information	25/06/2014 2:21 PM	File folder	
RunSanDiskSecureAccess_Win.exe	15/02/2012 1:39 AM	Application	29,987 KB

Figure 72 – USB Memory Stick File Structure

10. Insert the USB memory stick into your PC/Laptop computer and access the files.
11. Best practice is to email all the on the USB memory stick but if it's too large just send:
12. The CONFIG**.CFG and PARAM**.TXT files that are saved in the CONFIG folder.
13. The LOG files (Event Log text files) and data files (14=Year, Sub folder=month).
14. Safely Eject the USB from the PC/Laptop and return to the instrument.

This page is intentionally blank.

8. Optional Extras

8.1 Rack Mount Kit (PN E020116)

The rack mount kit is necessary for installing the Serinus into a 19" rack (the Serinus is 4RU in height).

Included Items

1	Rack Slide Set	H010112
4	Rack Mount Adaptors	H010133
2	Rack Mount Ears	H010134
4	Spacers	HAR-8700
8	M6 x 20 Button Head Screws	
16	M6 Washers	
8	M6 Nyloc Nuts	
18	M4 x 10 Button Head Screws	
8	M4 Washers	
8	M4 Nyloc Nuts	
8	M6 Cage Nuts	

Installing the Instrument

1. Remove the rubber feet from the instrument (if attached).
2. Separate the slide rail assembly by pressing the black plastic clips in the slide rails to remove the inner section of the rail.

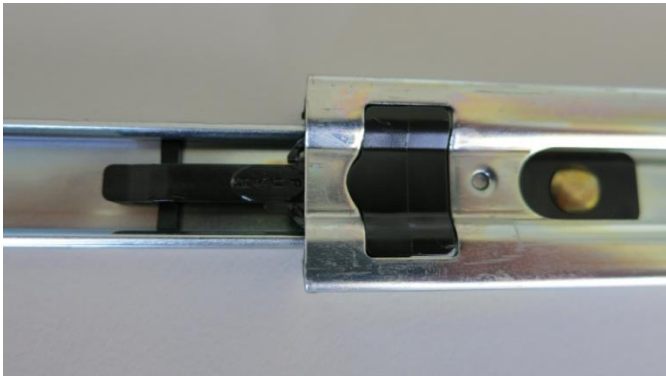

Figure 73 – Separate Rack Slides

3. Attach the inner slide rails to each side of the instrument using M4 x 10 button screws; three on each side (refer to Figure 74).



Figure 74 – Assemble Inner Slide on Chassis

4. Install rack mount ears on the front of the instrument using two M4 x 10 screws on each side (refer to Figure 75).



Figure 75 – Rack Mount Ears Fitted to Instrument

5. Attach the rack mount adaptors to the ends of the outer slide rails using M4 x 10 button screws, washers and locknuts. Do not fully tighten at this stage as minor adjustments will be required to suit the length of the rack (refer to Figure 76).



Figure 76 – Attach Rack Mount Adaptors to Outer Slides

6. Test fit the rack slide into your rack to determine the spacing of the rack mount adaptors.

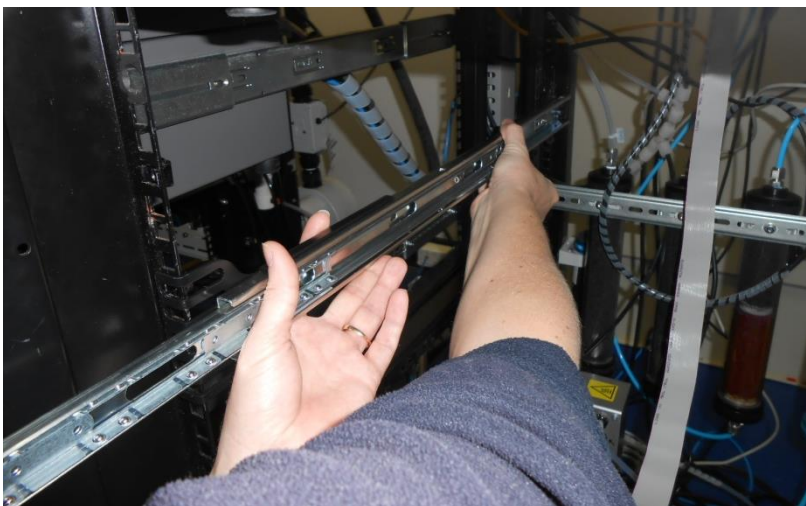

Figure 77 – Test Fit the Rack Slide Assembly Into Your Rack

7. Install the two assembled outer slide rails onto the left and right side of the rack securely with M6 bolts; washer and locknuts/cage nuts.

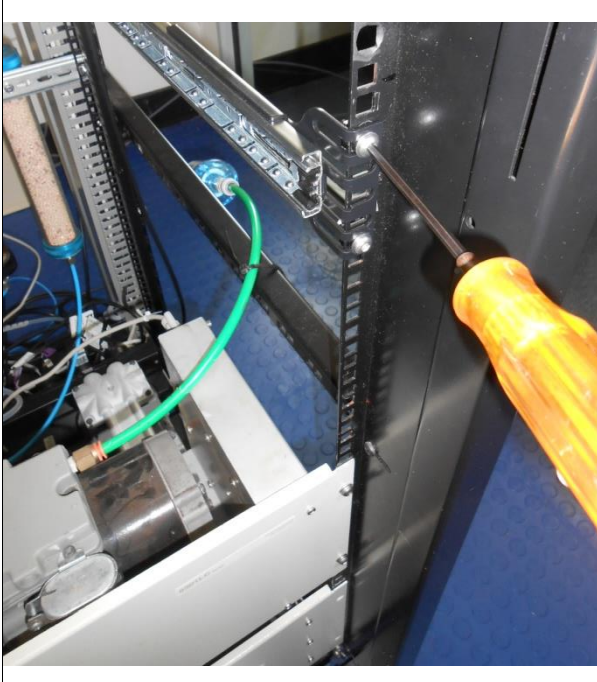

Figure 78 – Attach Slides to Front of Rack

8. Now carefully insert the instrument into the rack by fitting the instrument slides into the mounted rails. Ensuring that the rack slide locks engage on each side.



CAUTION

When installing this instrument ensure that appropriate lifting equipment and procedures are followed. It is recommended that two people lift the instrument into the rack due to the weight, unless proper lifting equipment is available.

Note: Ensure both sides of the inner slide are attached to the outer slides before pushing into the rack fully.

9. Push the instrument into the rack. Adjust and tighten the screws as required to achieve a smooth and secure slide.

To Remove the Instrument

1. To remove the instrument first pull instrument forward of rack giving access to the slides.
2. Find the rack slide lock labelled **Push** and push it in whilst sliding the instrument out of the rack, complete this for both sides while carefully removing instrument.



Figure 79 – Slide Clips

8.2 High Pressure Zero/Span Valves

High pressure span calibration valve (factory installed (PN E020108))

High pressure zero calibration valve (factory installed (PN E020109))

For more information on how to setup and use the high pressure valves refer to Section 5.9.

Note: Before using a high pressure span or zero as a source for calibrating the instrument, please check your local regulatory requirements.

This page is intentionally blank

9. Parts List and Schematics

9.1 Serinus Accessories Kit

This kit contains assorted fittings, tubing and an orifice removal tool which are useful when working on the instruments internal pneumatics. This is usually purchased with the instrument

Table 8 – Serinus Accessories Kit – (H010136)

Serinus Accessories Kit:	Part Numbers
Fitting, KYNAR UNIOUN TEE	F030007
Fitting KYNAR Union	F030008
Adapter, 1/4" FITTING TO 1/8"	H010007
Adapter, 1/4" TUBE TO 1/8" BARB	H010008
Orifice Extraction Tool	H010046
TUBING, TYGON 1/4 x 1/8 CLEAR (3 FEET)	T010011
TUBING, 1/4" OD, 1/8" ID BLACK (3 FEET)	T010021

9.2 Maintenance Kit

This maintenance kit is required when performing annual maintenance on the instrument. Depending on the environment that the instrument is operating, this maintenance may need to be carried out more often than yearly.

Table 9 – Serinus 44 Maintenance Kit – (E020206)

Serinus 44 Maintenance Kit: E020206	Part Number
SILICONE HEATSINK COMPOUND	C050013
DESICCANT 5 GRAM PACK	C050014
SCRUBBER NH3 100MM	ECO-1033-1
FILTER SINTERED SS	F010004
FILTER DFU 23 MICRON DIF-BN70	F010005
WASHER SHOULDER, NYLON M3 x 6	F050040
WASHER NEO, .174x .38x.016	F050041
SPRING COMPRESSION, 0.24 DIA	H010040
FILTER SINTERED	H010047-01
FILTER SINTERED,	H010053
O-RING 0.364ID X 0.070W	O010010
O-RING 0.426ID X 0.070W	O010011
O-RING 0.114ID X 0.07W, VITON	O010012

Serinus 44 Maintenance Kit: E020206	Part Number
O-RING, 5/32ID X 1/16W, BS007,	O010013
O-RING 1 11/16ID X 3/32W VITON	O010014
O-RING 1/4ID X 1/16W, VITON	O010015
O-RING 13/16ID X 1/16W, VITON	O010016
O-RING 1 5/8 X 1/16, VITON	O010017
O-RING 5 3/4ID X 3/32W, VITON	O010018
O-RING 0.208ID X 0.07W, VITON	O010021
O-RING 1.739ID X 0.07W, VITON	O010022
O-RING BS015, VITON	O010023
O-RING, BS006,	O010032
TUBING, TYGON, 1/4 X 1/8 CLEAR	T010011

9.3 Consumables

Parts shown as consumables below will require replacement over the course of the instrument's lifespan.

Table 10 – Serinus 44 Consumables

Consumable	Part Number
Filter paper Teflon 47MM pack of 50	F010006-01
Filter paper Teflon 47MM pack of 100	F010006
Dual Coil NO ₂ to NO Converter Assembly	H011105-44
Orifice – Sample #4	H010043-02
Orifice – Sample #8 (4 required)	H010043-06
Orifice – Sample #3	H010043-01
Tube/Spring assembly, O ₃ generator	H011120-01
External Pump Repair Kit (suite 607 pump)	P031001
Sintered filter, 5 micron	F010004
Filter Sintered With O-ring groove	H010047-01
Filter Sintered, Threaded Body, M8	H010053
Tygon Tubing, 25ft Length	T010011-01
Scrubber NH3 100mm	ECO-1033-1

***Warranty Disclaimer:** The product is subject to a warranty on parts and labour from date of shipment (the warranty period). The warranty period commences when the product is shipped from the factory. **Lamps, fuses, batteries and consumable items are not covered by this warranty.**

Subject to use refers to variable ambient conditions, toxic gases, dirt, extremes of temperature and moisture ingress may shorten the lifespan of components.

9.4 Instrument Parts List

List of Serinus 44 components and part numbers for reference.

Table 11 – Spare Parts List Serinus 44

Part Description	Part Number
PCA, Controller	E020230-01
Power Supply, Serinus, Auto-ranging	P010013
Filter, optical, reaction cell	H011205
Heater/thermocouple assembly NO _x converter	C020072
Heater/thermistor assembly (reaction cell, manifold)	C020073
Ozone generator and housing assembly	H011107
Retrofit/refurbishment kit, Ozone generator	H011134
Calibration valve manifold assembly	H010013-01
Cable, PMT power supply NO _x , gas analyser	C020050-01
Cooler, thermistor assembly	C020088
Thermistor assembly kit	H011211-04
Dryer assembly, permapure	H011106
Extraction tool, orifice and sintered filter with O-ring groove	H010046
PCA pressure sensor assembly	C010004
Fitting, Kynar, elbow 1/8 NPT - 1/8 barb (3 required)	F030005
Fitting, Kynar, male connector 1/8 NPT - 1/8 barb (2 required)	F030006
Male elbow, tapered threads, 1/8 T - 1/8 NPT, SS	F030025
Plug, test lamp	H010026
Test lamp	E020103
Serinus 44 user manual	M010034
Gasket pressure sensor	H010037
Sintered Filter, 5 micron	F010004

9.6 Block Wiring Schematic – (D020104)

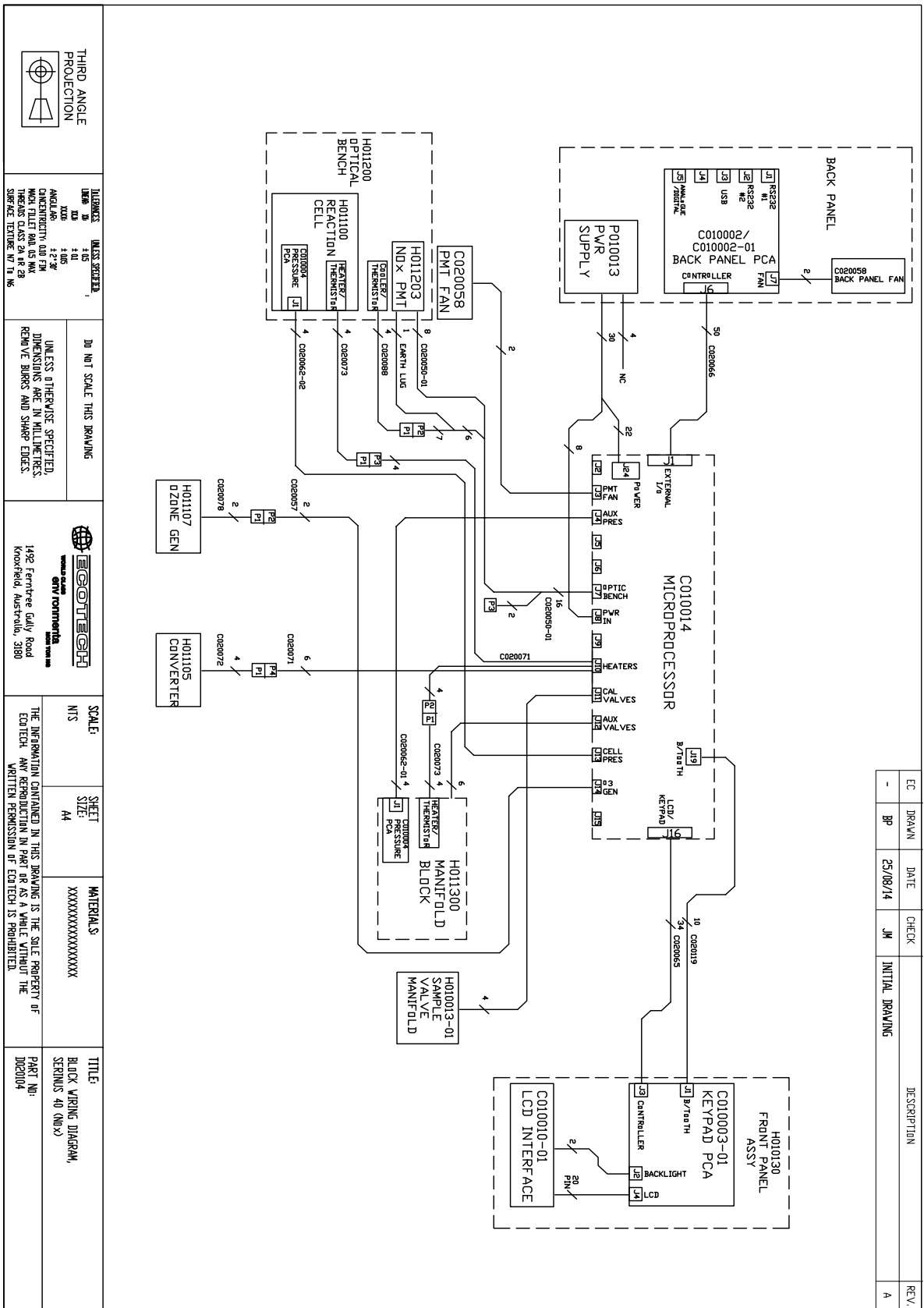

TOLERANCES		UNLESS SPECIFIED	
LENGTH	MM	± 0.5	
ANGLE	DEG	± 0.5	
DIAMETER	MM	± 0.05	
POSITION	MM	± 0.25	
PLACEMENT	MM	± 0.25	
DRILL	MM	± 0.05	
THREAD	MM	± 0.05	
SPACING	MM	± 0.05	
DEPTH	MM	± 0.05	
DRILL	MM	± 0.05	
THREAD	MM	± 0.05	
SPACING	MM	± 0.05	
DEPTH	MM	± 0.05	

DO NOT SCALE THIS DRAWING

UNLESS OTHERWISE SPECIFIED, DIMENSIONS ARE IN MILLIMETRES. REMOVE BURRS AND SHARP EDGES.

ecotech
 environmental monitoring solutions
 1492 Fernside Gully Road
 Knoxfield, Australia, 3180

SCALE	SHEET	MATERIALS	TITLE
MIS	44	XXXXXXXXXXXXXXXXXX	BLOCK WIRING DIAGRAM, SERIUS 40 (REV)

THE INFORMATION CONTAINED IN THIS DRAWING IS THE SOLE PROPERTY OF ECOTECH. ANY REPRODUCTION IN PART OR AS A WHOLE WITHOUT THE WRITTEN PERMISSION OF ECOTECH IS PROHIBITED.

PART NO: D020104

9.7 Ozone Generator Assembly – (H011107)

ITEM NO.	PART NUMBER	DESCRIPTION	QTY.
1	H01117-01	SHAFT CONDUCTOR OZONE GEN	1
2	H01116-01	RETAINER TUBE BLOCK OZONE GENERATOR	2
3	H011120	TUBE/SPRING ASSY. O3 GENERATOR	1
4	H011133	NUT, M25, OZONE GENERATOR	2
5	H011132	FERRULE TUBE, OZONE GENERATOR	2
6	O010035	O-RING, 3/16 ID X 3/32 PTFE	2
7	F030005	FITTING, KVMAR, ELBOW 1/8NPT - 1/8 BARB	2
8	H010041	PLUG DOME DP500	1
9	FASAM3SS-18	M3 Nut	2

EC	DRAWN	DATE	CHECK	DESCRIPTION	REV.
VC		07/03/12	JM	INITIAL DRAWING	A

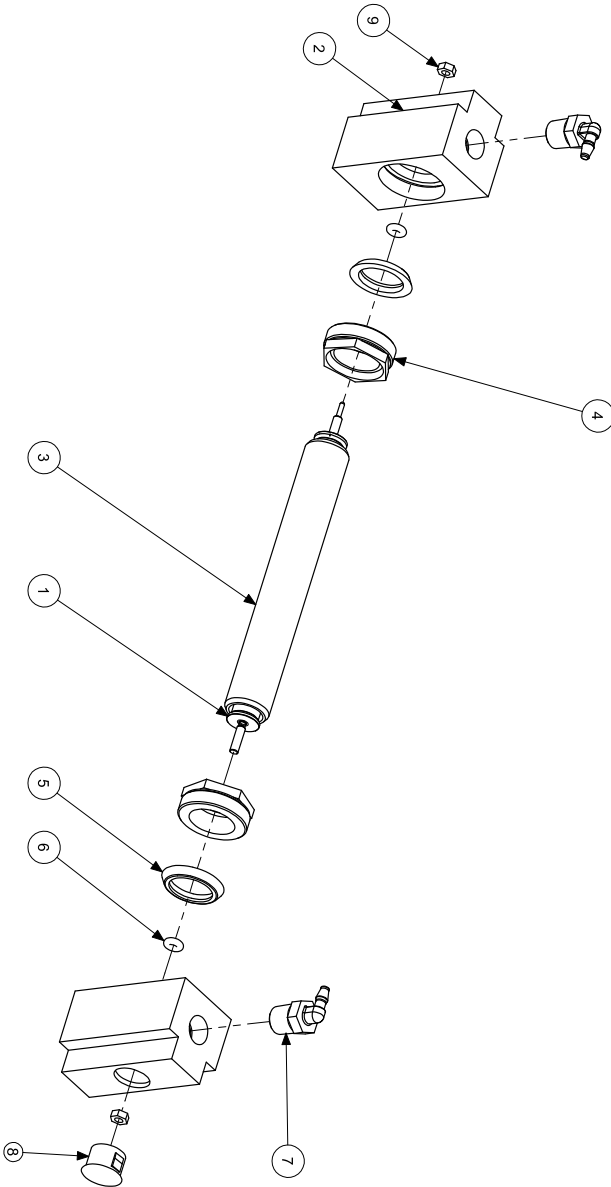

<p>UNLESS OTHERWISE SPECIFIED:</p> <p>UNITS: XX, 505 X, 10 X, 10.1 ANGULAR: 25° CONC. DIMENSIONS: 0.10 MM MACH. FINISH: 0.8 MAX SURFACE FINISH: 320 STRESS FINISH: 15 16</p>		<p>DO NOT SCALE THIS DRAWING</p>		<p>UNLESS OTHERWISE SPECIFIED, DIMENSIONS ARE IN MILLIMETERS. REMOVE BURRS AND SHARP EDGES.</p>		<p>1492 Pennine Gully Road Knoxfield, Australia, 3180</p>		<p>SCALE: 1:5</p>		<p>SHEET SIZE: A4</p>		<p>MATERIALS:</p>		<p>TITLE: OZONE GENERATOR ASSY, SERINUS</p>	
<p>THIRD ANGLE PROJECTION</p>		<p>1492 Pennine Gully Road Knoxfield, Australia, 3180</p>		<p>SHEET: 1 OF 1</p>		<p>THE INFORMATION CONTAINED IN THIS DRAWING IS THE SOLE PROPERTY OF ECOTECH. ANY REPRODUCTION IN PART OR AS A WHOLE WITHOUT THE WRITTEN PERMISSION OF ECOTECH IS PROHIBITED.</p>		<p>PART NO: H011107</p>		<p>ECOTECH ENGINEERING SOLUTION</p>		<p>1492 Pennine Gully Road Knoxfield, Australia, 3180</p>		<p>1492 Pennine Gully Road Knoxfield, Australia, 3180</p>	

9.11 Valve Assembly – (H010042)

ITEM NO.	PART NUMBER	QTY.
1	SOLENOID COIL BODY	1
2	SOLENOID COIL	1
3	NUT	1
4	PLUNGERS	1
5	O010016	1
6	O010015	1
7	O010010	1
8	O010023	1
9	Stem	1

STEPS TO REPLACE O-RINGS

1. MARK THE SOLENOID COIL WITH A PERMANENT MARKER TO IDENTIFY THEIR RESPECTIVE VALVES AND THEIR POSITION ON MANIFOLD BLOCK
2. SECURE THE 3-WAY VALVE UPRIGHT INTO A LARGE VICE WITH PROTECTION AROUND ITS BODY TO PREVENT SCRATCH OR DAMAGE TO VALVE
3. REMOVE NUT FROM THE TOP OF THE 3-WAY VALVE USING A 9/16" SPANNER
4. REMOVE SMALL O-RING FROM AROUND 3 WAY VALVE USING 2 MM FLAT SCREW DRIVER
5. LIFT OFF THE SOLENOID COIL FROM THE 3-WAY VALVE THEN UNCREW THE SHAFT FROM THE BASE USING A LARGE FLAT SCREW DRIVER WHILE UNSCREWING TAKE CARE THAT THE INTERNAL PLUNGER DOES NOT FALL OUT
6. REPLACE THE INTERNAL O-RING WITH O010023
7. ASSEMBLE THE SHAFT ALONG WITH PLUNGER BACK IN ITS POSITION
8. ASSEMBLE THE SOLENOID WITH ITS RESPECTIVE VALVE
9. ASSEMBLE NEW O-RING SUPPLIED
10. ASSEMBLE THE NUT ON TOP OF 3-WAY VALVE
11. ASSEMBLE O010016 AND O010010 O-RINGS ON THE BOTTOM OF THE VALVE
12. ASSEMBLE VALVE BACK IN MANIFOLD BLOCK

H010042
3 WAY VALVE SERVICE PROCEDURE

Appendix A. Advanced Protocol Parameter List

Note: Parameters are for all Serinus series analysers and may not be applicable to an individual instrument.

Table 12 – Advanced Protocol Parameter List

#	Description	Notes
1	Cal/Zero Valve	0=Zero, 1=Cal
2	Internal Span Valve	0=Closed, 1=Open
3	Spare Valve 1	0=Closed, 1=Open
4	Spare Valve 2	0=Closed, 1=Open
5	Spare Valve 3	0=Closed, 1=Open
6	Sample/Cal Valve	0=Sample, 1=Cal/Zero
7	NOx Measure Valve	0=NO, 1=NOx
8	NOx Bypass Valve	0=NO, 1=NOx
9	NOx Backgnd Valve	0=Closed, 1=Open
10	Valve Sequencing	0=Off, 1=On
11	LCD Contrast Pot	0=Lightest, 255=Darkest
12	SO2 Ref Zero Pot	S50 Reference zero pot
13	CO Input Pot	S30 Input pot
14	CO Reference Test Pot	Not Used
15	CO Measure Pot	Not Used
16	High Volt Adjust Pot	PMT High Voltage Adjust Pot for S50 & S40
17	SO2 Lamp Adjust Pot	S50 Lamp adjustment Pot
18	O3 Lamp Adjust Pot	S10 Lamp adjustment Pot
19	O3 Meas. Zero Pot (Coarse)	S10 Signal zero measure (coarse)
20	O3 Meas. Zero Pot (Fine)	S10 Signal zero measure (fine)
21	PMT Fan Pot	Optical Bench fan speed control pot
22	Rear Fan Pot	Chassis Fan speed control pot
23	Pump Coarse Pot	Internal Pump speed fine pot
24	Pump Fine Pot	Internal Pump speed coarse pot
25	Analog input 0	SO2 Reference signal
26	Analog input 1	CO Reference signal
27	Analog input 2	O3 Reference signal
28	Analog input 3	SO2 & O3 Lamp current
29	Analog input 4	Flow block pressure

30	Analog input 5	Cell pressure
31	Analog input 6	Ambient pressure
32	Analog input 7	Raw ADC calibration input
33	Analog input 8	MFC1 Not used
34	Analog input 9	Concentration data
35	Analog input 10	MFC2 Not used
36	Analog input 11	MFC3 Not used
37	Analog input 12	EXTERNAL ANALOG INPUT 0
38	Analog input 13	EXTERNAL ANALOG INPUT 1
39	Analog input 14	EXTERNAL ANALOG INPUT 1
40	Analog input 15	MFC0 Not used
41	CO Meas. Zero Pot (coarse)	S30 Measure ZERO coarse adjustment Pot
42	CO Meas. Zero Pot (fine)	S30 Measure ZERO fine adjustment Pot
43	SO2 Input Pot	SO2 Measure Signal Gain Pot
44	SO2 Ref. Gain Pot	SO2 Reference Signal Gain Pot
45	SO2 Meas. Zero Pot	SO2 Measure zero pot
46	O3 Input Pot	O3 Input signal gain pot
47	Diagnostic Test Pot	The Diagnostic mode adjustment pot for all the instrument except for S30
48	NOx Input Pot	PMT signal input gain control FOR NOX
49	PGA Gain	1, 2, 4, 8, 16, 32, 64, 128
50	Gas 1 Conc.	Primary gas concentration currently displayed on the front screen E.g. NO
51	Gas 2 Conc.	Secondary gas concentration currently displayed on front screen E.g. NOx
52	Gas 3 Conc.	Calculated gas concentration currently displayed on front screen E.g. NO2
53	Gas 1 Avg.	Average of the readings (for Gas1) of the last n minutes where n is the averaging period
54	Gas 2 Avg.	Average of the readings (for Gas2) of the last n minutes where n is the averaging period
55	Gas 3 Avg.	Average of the readings (for Gas3) of the last n minutes where n is the averaging period
56	Instrument Gain	Current calibration value (default is 1.0)
57	Serial ID	Multidrop or Bayern-Hessen gas id
58	Bayern-Hessen 2nd ID	For multigas instruments only
59	Decimal Places	2-5
60	Noise	Instrument noise

61	Gas 1 Offset	A offset applied to Gas 1
62	Gas 3 Offset	A offset applied to Gas 3
63	Flow Temperature	Temperature of the flow block
64	Lamp Current	Lamp current in mA E.g. 35mA
65	Digital Supply	Digital Supply voltage (should always read close to 5 volts)
66	Conc. Voltage	Concentration Voltage
67	High Voltage	High Voltage reading for PMT
68	Ozonator	0=Off, 1=On
69	Control Loop	0=Off, 1=On (default is On)
70	Diagnostic Mode	0=Operate 1=Preamp 2=Electrical 3=Optical (default is Operate)
71	Gas Flow	
72	Gas Pressure	
73	Ambient Pressure	
74	12V Supply	The 12 volt Power supply voltage
75	Cell Temperature	Cell Temperature
76	Conv. Temperature	Converter Temperature
77	Chassis Temperature	Chassis Temperature
78	Manifold Temp.	Manifold Temperature
79	Cooler Temperature	Cooler Temperature
80	Mirror Temperature	Mirror Temperature
81	Lamp Temperature	Lamp Temperature
82	O3 Gen Lamp Temperature	O3 Lamp Temperature
83	Instrument Status	
84	Reference Voltage	
85	Calibration State	0 = MEASURE 1 = CYCLE 2 = ZERO 3 = SPAN
86	Primary Raw Conc.	(For S40, before NOx background and gain)
87	Secondary Raw Conc.	Only for multigas instruments (For S40, before NOx background and gain)
88	S40 Backgnd Conc.	NOx Background Concentration (For S40, before gain)

89	Cal. Pressure	Calibration Pressure
90	Conv. Efficiency	Converter Efficiency
91	Multidrop Baud Rate	
92	Analog Range Gas 1	
93	Analog Range Gas 2	
94	Analog Range Gas 3	
95	Output Type Gas 1	Output Type Gas 1 1=Voltage 0=Current
96	Output Type Gas 2	Output Type Gas 2 1=Voltage 0=Current
97	Output Type Gas 3	Output Type Gas 3 1=Voltage 0=Current
98	Anlg Ofst/Rng Gas1	Voltage Offset /Current Range Gas1 0=0% or 0-20mA 1=5% or 2-20mA 2=10% or 4-20mA
99	Anlg Ofst/Rng Gas2	Voltage Offset /Current Range Gas2 0=0% or 0-20mA 1=5% or 2-20mA 2=10% or 4-20mA
100	Anlg Ofst/Rng Gas3	Voltage Offset /Current Range Gas3 0=0% or 0-20mA 1=5% or 2-20mA 2=10% or 4-20mA
101	F/Scale Volt Gas 1	5.0 Volt Calibration value for Analog Output 1
102	F/Scale Volt Gas 2	5.0 Volt Calibration value for Analog Output 2
103	F/Scale Volt Gas 3	5.0 Volt Calibration value for Analog Output 3
104	Z Adj Volt Gas 1	0.5 Volt Calibration value for Analog Output 1
105	Z Adj Volt Gas 2	0.5 Volt Calibration value for Analog Output 2
106	Z Adj Volt Gas 3	0.5 Volt Calibration value for Analog Output 3
107	Negative Supply	Negative 10V Supply
108	Reserved	
109	Reserved	
110	Instrument State	
111	CO Lin. Factor A	CO Linearisation Factor A
112	CO Lin. Factor B	CO Linearisation Factor B

113	CO Lin. Factor C	CO Linearisation Factor C
114	CO Lin. Factor D	CO Linearisation Factor D
115	CO Lin. Factor E	CO Linearisation Factor E
116	Instrument Units	0= PPM 1=PPB 2=PPT 3=mG/M ³ 4=μG/M ³ 5=nG/M ³ 6=%
117	Backgnd Meas. Time	In seconds
118	Sample Fill Time	
119	Sample Measure Time	
120	Aux Measure Time	
121	Aux Smpl. Fill Time	
122	Backgnd Fill Time	
123	Zero Fill Time	
124	Zero Measure Time	
125	Span Fill Time	
126	Span Measure Time	
127	Span Purge Time	
128	Backgnd Pause Time	
129	Bkgnd Intrleav Fact	
130	Cal. Pressure 2	Calibration Pressure for 2 nd gas
131	2nd Instrument Gain	Unused (always reports 1.0)
132	Background voltage	
132	Reserved	
133	Reserved	
134	Reserved	
135	Reserved	
136	Reserved	
137	Reserved	
138	Reserved	
139	Reserved	
140	Reserved	
141	Reserved	
142	Reserved	

143	Reserved	
144	Reserved	
145	Cycle Time	In minutes
146	CO Cooler Pot	CO Cooler voltage adjustment POT
147	CO Source Pot	CO Source voltage adjustment POT
148	CO Test Meas. Pot	Diagnostics use only
149	CO Test Ref. Pot	Diagnostics use only
150	O3 Ref Average	S10 Background Average
151	PTF Correction (gas 1)	Pressure Temperature Flow Compensation Factor for first gas
152	PTF Correction (gas 2)	Pressure Temperature Flow Compensation Factor for second gas in dual gas instrument.
153	Inst. Cell Pressure	Instantaneous cell pressure
154	Manifold Pressure	Valve Manifold Pressure
155	Cell Press. (gas1)	Cell Pressure for Gas 1
156	Cell Press. (gas2)	Cell Pressure for Gas 2
157	Cell Press. (Background)	Cell Pressure when in Background
158	Background	0= the instrument is measuring a gas sample 1= the instrument is measuring background air
159	Gas To Measure	S51 only; see Measurement Settings Menu 0 = Measure both gasses 1 = Measure SO2 only 2 = Measure H2S only
160	Valve States	Diagnostic use only
161	Temperature Units	0 = "°C", 1 = "°F", 2 = "°K",
162	Pressure Units	0 = "torr", 1 = "psi", 2 = "mbar", 3 = "atm", 4 = "kPa"

163	Averaging Period	0 = " 1 Min", 1 = " 3 Mins", 2 = " 5 Mins", 3 = "10 Mins", 4 = "15 Mins", 5 = "30 Mins", 6 = " 1 Hr", 7 = " 4 Hrs", 8 = " 8 Hrs", 9 = " 12 Hrs", 10 = " 24 Hrs"
164	Filter Type	NO FILTER = 0, KALMAN FILTER = 1, 10 SEC FILTER = 2, 30 SEC FILTER = 3, 60 SEC FILTER = 4, 90 SEC FILTER = 5, 300 SEC FILTER = 6, ADPTIVE FILTER =7
165	NO2 Filter enabled	0 = Disabled, 1 = Enabled
166	Background Interval	0 = 24 Hrs 1 = 12 Hrs 2 = 8 Hrs 3 = 6 Hrs 4 = 4 Hrs 5 = 2 Hrs 6 = Disable
167	Service (COM1) Baud	Serial baud rate
168	Multidrop(COM2)Baud	0 = 1200 bps 1 = 2400 bps 2 = 4800 bps 3 = 9600 bps 4 = 14400 bps 5 = 19200 bps 6 = 38400 bps
169	Service Protocol	0 = EC9800
170	Multidrop Protocol	1 = Bayern-Hassen 2 = Advanced 3 = Modbus
171	Gas1 Over Range	The Upper Concentration Range when Over-Ranging is enabled for Analog Output 1
172	Gas2 Over Range	The Upper Concentration Range when Over-Ranging is enabled for Analog Output 2

173	Gas3 Over Range	The Upper Concentration Range when Over-Ranging is enabled for Analog Output 3
174	Gas1 Over-Ranging	0 = Over Ranging Disabled 1 = Over Ranging Enabled (Gas1)
175	Gas2 Over-Ranging	0 = Over Ranging Disabled 1 = Over Ranging Enabled (Gas2)
176	Gas3 Over-Ranging	0 = Over Ranging Disabled 1 = Over Ranging Enabled (Gas3)
177	Heater Set Point	Cell Heater Set Point
178	Reserved	
179	PMT Test LED Pot	PMT Test LED intensity controller POT
180	Last Power Failure	Time Stamp of the Last power fail (4 byte time stamp) Bit 31:26 ---- Year (0 – 99) Bit 25:22 ---- Month (1 – 12) Bit 21:17 ---- Date (1 – 31) Bit 16:12 ---- Hour (00 – 23) Bit 11:06 ---- Min (00 – 59) Bit 05:00 ---- Sec (00 – 59)
181	Inst Manifld Pres.	Instantaneous Manifold Pressure in S40 instrument (no filter)
182	Cell Press. (gas3)	E.g. NH3 in an S44
183	Gas 4 Conc.	E.g. NH3 in an S44
184	Gas 4 Avg.	
185	Gas 5 Conc.	E.g. NH3 on an S44
186	NH3 Conv.Efficiency	Gas 3 (eg:NO2)
187	Cell/Lamp Duty Cycle	
188	Mirror T. Duty Cycle	
189	Flow Temp Duty Cycle	
190	Cooler T. Duty Cycle	
191	Conv Temp Duty Cycle	
192	CO Conv T Duty Cycle	
193	F/Scale Curr Gas 1	
194	F/Scale Curr Gas 2	
195	F/Scale Curr Gas 3	
196	Z Adj Curr Gas 1	
197	Z Adj Curr Gas 2	
198	Z Adj Curr Gas 3	
199	Ext Analog Input 1	

200	Ext Analog Input 2	
201	Ext Analog Input 3	
202	H2S Conv Set Point	Converter Set Point
203	Cal. Pressure 3	Calibration Pressure 3
204	PTF Correction (gas 3)	Pressure Temperature Flow Compensation Factor for third gas in multigas instruments.
205	Dilution Ratio	The current dilution ratio (default is 1.0)
206	Traffic Light	State of the status light: 0 = Green 1 = Amber 2 = Off (normally impossible) 3 = Red
207	Network Protocol	0 = EC9800 1 = Bayern-Hassen 2 = Advanced 3 = Modbus
208	Gas 4 Offset	
209	O3 GEN Fine Pot	Ozone generator control. Output value depends on whether the instrument is pot or DAC controlled. Pot: 0..255 DAC: 0..64535
210	O3 Gen Lamp Current	mA
211	O3 GEN Coarse Pot	Ozone generator control Pot: 0..99 DAC: Repeat of parameter 209
212	Logging Period	The data logging period, in seconds (1.. 86400)
213	O3 Gen Coeff A	Ozone generator coefficients
214	O3 Gen Coeff B	
215	O3 Gen Coeff C	

Appendix B. EC9800 Protocol

The following commands are supported.

DCONC

Function: Sends the current instantaneous concentration data to the serial port.

Format: DCONC,{<DEVICE I.D.>}{TERMINATOR}

Device response: {GAS}<SPACE>{STATUS WORD}<CR><LF>

All numbers are in floating point format. The STATUS WORD indicates the instrument status in hex using the following format:

- Bit 15 = SYSFAIL (MSB)
- Bit 14 = FLOWFAIL
- Bit 13 = LAMPFAIL
- Bit 12 = CHOPFAIL
- Bit 11 = CVFAIL
- Bit 10 = COOLERFAIL
- Bit 9 = HEATERFAIL
- Bit 8 = REFFAIL
- Bit 7 = PS-FAIL
- Bit 6 = HV-FAIL
- Bit 5 = OUT OF SERVICE
- Bit 4 = Instrument is in zero mode
- Bit 3 = Instrument is in span mode
- Bit 2 = Unused
- Bit 1 = SET→PPM selected, CLEAR→MG/M3
- Bit 0 = reserved (LSB).

DSPAN

Function: Commands the unit under test to enter the span mode and stay there.

Format: DSPAN,{<DEVICE I.D.>}{TERMINATOR}

Device response: <ACK> if the unit under test is able to perform the command, <NAK> if not

DZERO

Function: Commands the unit under test to enter the zero mode and stay there.

Format: DZERO,{<DEVICE I.D.>}{TERMINATOR}

Device response: <ACK> if the unit under test is able to perform the command, <NAK> if not

ABORT

Function: Commands the addressed device to abort the current mode and return to the measure mode.

Format: ABORT,{<DEVICE I.D.>}{TERMINATOR}

Device response: <ACK> if the unit under test is able to perform the command, <NAK> if not

RESET

Function: Reboots the instrument (software reset).

Format: RESET, {<DEVICE I.D.>}{TERMINATOR}

Device response: <ACK>

Appendix C. Bayern-Hassen Protocol

All Bayern-Hassen Network commands follow the command format as specified in this section.

Bayern-Hassen Network Command Format

<STX><text><ETX><bcc1><bcc2>

Where:

- <STX> = ASCII Start of Transmission = 0x02 hex
- <Text> = ASCII text maximum length of 120 characters
- <ETX> = ASCII end of transmission = 0x03 hex
- <bcc1> = ASCII representation of block check value MSB
- <bcc2> = ASCII representation of block check value LSB.

The block check algorithm begins with 0 and exclusive-OR's each ASCII character from <STX> to <ETX> inclusive. This block check value is converted to ASCII format and sent after the <ETX> character.

Examples

This is an example of a valid Bayern-Hassen data request for an instrument that has an ID of 97:

<STX>DA097<ETX>3A

The block check calculation is best shown by the following example:

Table 13 – Bayern-Hassen Data

Character	Hex Value	Binary	Block Check
<STX>	02	0000 0010	0000 0010
D	44	0100 0100	0100 0110
A	41	0100 0001	0000 0111
0	30	0011 0000	0011 0111
9	39	0011 1001	0000 1110
7	37	0011 0111	0011 1001
<ETX>	03	0000 0011	0011 1010

The binary value 0011 1010 corresponds to the hex value 3A. This value in ASCII forms the last two characters of the data request message.

Note: The I.D. of 97 is sent as the sequence 097. All I.D. strings must have three digits and you should always pad with ASCII zero characters.

This is an example of a valid command to put the unit in the manual span mode if the instrument has an ID of 843:

<STX>ST843 K<ETX>52

The block check operation is best shown with the following table:

Table 14 – Block Check Operation

Character	Hex Value	Binary	Block Check
<STX>	02	0000 0010	0000 0010
S	53	0101 0011	0101 0001
T	54	0101 0100	0000 0101
8	38	0011 1000	0011 1101
4	34	0011 0100	0000 1001
3	33	0011 0011	0011 1010
<SPACE>	20	0010 0000	0001 1010
K	4B	0100 1011	0101 0001
<ETX>	03	0000 0011	0101 0010

The binary block check value is 0101 0010 which is the hex value 52 as shown at the end of the command string.

Supported Commands

The command set supported by the Bayern-Hassen protocol is:

Table 15 – Bayern-Hassen Protocol Commands

Command	Effect
DA<id>	Returns gas concentration.
DA	Returns gas concentration w/o id.
ST<id> M	Enter Measure mode.
ST<id> N	Enter Zero mode.
ST<id> K	Enter Span mode.
ST<id> S	Force a background check.

DA

Return the current instantaneous concentration.

Format

<STX>{DA}{<kkk>}<ETX>< bcc1><bcc2>

Or

<STX>{DA}<ETX>< bcc1><bcc2>

Where:

kkk = Device's Serial ID

bcc1 = First byte of the block check calculation

bcc2 = Second byte of the block check calculation

Device response (S10, S30 and S50 family)

<STX>{MD}{01}<SP><kkk><SP><+nnnn+ee><SP><ss><SP><ff><{000}><SP><{00000000}>

<SP><ETC>< bcc1><bcc2>

Device response (S40 family)

<STX>{MD}{02}<SP><kkk><SP><+nnnn+ee><SP><ss><SP><ff><SP><{00000000}>

<SP><mmm><SP><+pppp+ee><SP><ss><SP><ff><SP><{00000000}>

<SP><ETC><bcc1><bcc2>

Where:

<SP> = Space (0x20 hex)

kkk = Device's Serial ID. If the DA command is issued without an ID, the response omits this field.
Exception: the S40 family always includes both ID fields, even when a DA command without an ID is issued.

+nnnn+ee = Main instantaneous gas concentration (for S40 family, this is NO)

ss = Status byte with the following bit map:

Table 16 – Bit Map

Status Bit	Meaning if set to 1
0	Instrument off (this value is always set to 0).
1	Out of service.
2	Zero mode.
3	Span mode.
4	-
5	-
6	Units: 1 = Volumetric, 0 = Gravimetric.
7	Background mode (S30 and S50 family only).

ff = Failure byte for both channels with the following bit map (positive logic):

Table 17 – Bit Map (positive logic)

Failure Bit	Meaning if set to 1
0	Flow sensor failure.
1	Instrument failure.
2	-
3	Lamp failure (S40 family only).
4	-
5	Cell heater failure (S30, S40 and S50 family only).
6	-
7	-

mmm = NO instrument ID

+pppp+ee = NO_x gas concentration (unless the NO₂ option was selected in the **Serial Communications Menu**, in which case it is NO₂)

bcc1 = First byte of the block check calculation

bcc2 = Second byte of the block check calculation

ST

Set the instrument mode.

Format

<STX>{ST}{< kkk>}<SP>{command}<ETC><bcc1><bcc2>

Where:

kkk = Device's Serial ID

Command = M, N or K for Measure, Zero or Span mode

bcc1 = First byte of the block check calculation

bcc2 = Second byte of the block check calculation

Appendix D. ModBus Protocol

The Serinus supports a limited Modbus implementation.

The only function codes supported are 3 (read holding register) and 16 (write multiple registers).

Read Holding Register

The user must specify a slave address for Serial requests (but not for TCP requests). This value is the Serinus **Serial ID**.

Read requests specify which Advanced Protocol IEEE value they want to read as the starting reference. Refer to Table 12 – Advanced Protocol Parameter List to see what values are available and what index to specify for them. The ModBus index is calculated from the Advanced Protocol index via the following formula:

Modbus Index = Advanced Protocol Parameter List number x 2 + 256

The user may read from 2 to 124 registers.

Note: The user must read an even number of registers because the return data is always 4 bytes (a float).

The Serinus expects eight data bits, one stop bit and no parity. The baud rate is specified by the **Serial Communications Menu**.

The value will be returned as a big-endian 32-bit IEEE floating point value.

Write Multiple Registers

The user must specify a slave address for Serial requests (but not for TCP requests). This value is the Serinus **Serial ID**.

The start reference is the same as for reading.

Only two registers may be written at a time; that is, a single IEEE value. Currently the only supported value is 85, to put the instrument into span (3), zero (2), cycle (1) or measure (0) mode.

This page is intentionally blank



POWERED BY ACOEM

metone.com

User manual subject to change without notice. Images used are for illustrative purposes only.
All trademarks and registered trademarks are the property of their respective owners.
© 2022 Acoem and all related entities. All rights reserved.