

USER MANUAL

GAS-1051

O₂/H₂S Analyzer

Version 3.0



POWERED BY ACOEM

metone.com



POWERED BY ACOEM

Met One Instruments is now part of the Acoem Group. The Met One range of gas analyzers was originally developed by Acoem under the brand name Ecotech Serinus®.

For the purposes of expediting the availability of Met One gas analyzers to Met One customers around the world; Met One Instruments have chosen to use the original Ecotech Serinus® operating manual.

Although the name of the Met One instrument is different, the analyzer itself has remained unchanged and meets the strictest quality and performance requirements expected of Met One equipment. All the information presented in this manual is current, including analyzer specifications and operating principles.

Met One will update this manual to reflect the new branding convention in due course.

Table of Contents

Manufacturer’s Statement	10
Safety Requirements	11
Warranty.....	11
Service and Repairs.....	12
CE Mark Declaration of Conformity	13
Claims for Damaged Shipments and Shipping Discrepancies	14
Internationally Recognised Symbols on Ecotech Equipment.....	15
Manual Revision History	16
1. Introduction.....	17
1.1 Description	17
1.2 Specifications	17
1.2.1 Measurement	17
1.2.2 Precision/Accuracy	17
1.2.3 Calibration	17
1.2.4 Power	18
1.2.5 Operating Conditions.....	18
1.2.6 Communications.....	18
1.2.7 Physical Dimensions.....	19
1.3 Nomenclature	19
1.4 Background/Theory.....	20
1.4.1 Measurement Theory - Sulfur Dioxide.....	21
1.4.2 Measurement Theory - Hydrogen Sulphide.....	22
1.4.3 Kalman Filter Theory.....	22
1.5 Instrument Description	23
1.5.1 Calibration Valve Manifold	23
1.5.2 Particulate Filter	23
1.5.3 Hydrocarbon Kicker	23
1.5.4 Zero Air Scrubber.....	24
1.5.5 Reaction Cell	24
1.5.6 Optical Bench.....	24
1.5.7 Selective SO ₂ Scrubber.....	24
1.5.8 SO ₂ Humidifier	25
1.5.9 Internal Converter	25
1.5.10 Lamp Driver PCA	25
1.5.11 Pressure Sensor PCA	26
1.5.12 Pneumatic Tubing	26
1.5.13 Main Controller PCA	26
1.5.14 Power Supply	26
1.5.15 On/Off Switch	27
1.5.16 Communications.....	27
2. Installation.....	29
2.1 Initial Check	29
2.2 Installation Notes	30

2.3	Instrument Set-up.....	31
2.3.1	Pneumatic Connections	32
2.3.2	Power Connections	33
2.3.3	Communications Connections.....	33
2.3.4	Instrument Set-up	34
2.4	Transporting/Storage.....	34
3.	Operation.....	37
3.1	Warm-Up	37
3.2	Measurement	37
3.3	General Operation Information	38
3.3.1	Keypad & Display.....	38
3.3.2	Main Display.....	40
3.4	Menus & Screens	41
3.4.1	Quick Menu	41
3.4.2	Main Menu.....	42
3.4.3	Analyser State Menu	42
3.4.4	Status Menu	43
3.4.5	Temperature Menu	44
3.4.6	Pressure & Flow Menu	45
3.4.7	Voltage Menu.....	45
3.4.8	General Settings Menu.....	45
3.4.9	Measurement Settings Menu.....	46
3.4.10	Calibration Menu	47
3.4.11	Pressure Calibration Menu.....	49
3.4.12	Service Menu.....	49
3.4.13	Diagnostics Menu	50
3.4.14	Digital Pots Menu	50
3.4.15	Valve Menu	51
3.4.16	Tests Menu.....	53
3.4.17	Digital Input Test Menu	53
3.4.18	Digital Output Test Menu.....	53
3.4.19	Calculation Factors Menu.....	53
3.4.20	Communications Menu	54
3.4.21	Data Logging Menu	55
3.4.22	Serial Communication Menu	55
3.4.23	Analog Input Menu	55
3.4.24	Analog Output Menu.....	56
3.4.25	Digital Input Menu	57
3.4.26	Digital Output Menu	58
3.4.27	Network Menu	59
3.4.28	Bluetooth Menu	60
3.4.29	Advanced Menu	60
3.4.30	Hardware Menu	61
3.4.31	Parameter Display Menu.....	62
4.	Communications.....	63
4.1	RS232 Communication.....	63
4.2	USB Communication	64
4.3	TCP/IP Network Communication (optional)	65
4.3.1	Network Setup	66

4.3.2	Port Forwarding on Remote Modem/Router Setup	66
4.3.3	Airodis Setup to Communicate with Serinus	67
4.4	Digital/Analog Communication	68
4.4.1	Analog Outputs	68
4.4.2	Analog Inputs	69
4.4.3	Digital Status Inputs	70
4.4.4	Digital Status Outputs	70
4.5	Logging Data	71
4.5.1	Configure Instrument Internal Logging	71
4.6	Using Airodis Software to Download Data	72
4.6.1	Connecting the Instrument to Your PC	72
4.6.2	Installing Airodis	75
4.6.3	Configuring Airodis	75
4.7	Serinus Remote App/Bluetooth	81
4.7.1	Installation	81
4.7.2	Connecting to the Instrument	82
4.7.3	Instrument Control	83
4.7.4	Real-Time Plot	84
4.7.5	Download	85
4.7.6	Get Parameters	86
4.7.7	Preferences	87
5.	Calibration	89
5.1	Overview	89
5.2	Pressure Calibration	91
5.2.1	Full Pressure Calibration	91
5.2.2	Ambient Point Pressure Calibration	92
5.3	Zero Calibration	93
5.3.1	Calibration Port	93
5.3.2	Sample Port	93
5.3.3	Background Air Port	94
5.4	Span Calibration	94
5.4.1	Calibration Port	94
5.4.2	Sample Port	95
5.4.3	Manual Instrument Gain and Offset Adjustments	95
5.5	Precision Check	96
5.6	Multipoint Precision Check	96
5.7	H ₂ S Converter Efficiency Check	98
5.8	High Pressure Zero/Span Valve	99
5.8.1	Single Pressurised Calibration Option	99
5.8.2	Dual Pressurised Calibration Option	101
6.	Service	103
6.1	Maintenance Tools	103
6.2	Maintenance Schedule	104
6.3	Maintenance Procedures	105
6.3.1	Particulate Filter Replacement	105
6.3.2	Clean Fan Filter	106
6.3.3	DFU Replacement	107
6.3.4	Leak Check	107

6.3.5	Replacing the PMT Desiccant Pack.....	108
6.3.6	Replace Zero Air Scrubber.....	109
6.3.7	Orifice Replacement.....	110
6.3.8	UV Lamp Alignment.....	111
6.3.9	Clean Pneumatics.....	112
6.3.10	Pressure Sensor Check.....	113
6.4	Bootloader.....	114
6.4.1	Display Help Screen.....	114
6.4.2	Communications Port Test.....	114
6.4.3	Updating Firmware.....	114
6.4.4	Erase All Settings.....	115
6.4.5	Start Analyser.....	115
7.	Troubleshooting.....	117
7.1	Flow Fault.....	121
7.2	Noisy/Unstable Readings.....	122
7.3	Electronic Zero Adjust.....	123
7.4	SO ₂ Reaction Cell Temperature Failure.....	124
7.5	USB Memory Stick Failure.....	125
7.6	Ecotech Service Support Files.....	126
8.	Optional Extras.....	129
8.1	Dual Sample Filter (PN E020100).....	129
8.2	Rack Mount Kit (PN E020116).....	129
8.3	High Pressure Zero/Span Valves.....	133
9.	Parts List and Schematics.....	135
9.1	Serinus Accessories Kit.....	135
9.2	Maintenance Kit.....	135
9.3	Consumables.....	136
9.4	Instrument Parts List.....	137
9.5	Plumbing Schematic – (PN: D020019).....	139
9.6	Block Wiring Schematic – (PN: D020105).....	140
9.7	Reaction Cell Assembly– (PN: H012100).....	141
9.8	Lamp Holder Assembly– (PN: H012120).....	142
9.9	Dump Assembly– (PN: H012110).....	143
9.10	Optical Bench Assembly – (PN: H012130).....	144
9.11	Aux Manifold Assembly– (PN: H012150-01).....	145
9.12	Calibration Manifold Assembly– (PN: H010013-01).....	146
9.13	Valve Assembly – (PN: H010042).....	147

List of Figures

Figure 1 – Simple Pneumatic Diagram.....	21
Figure 2 – Optical Measurement Theory.....	22
Figure 3 – Major Components.....	23

Figure 4 – Lamp Type Switch Setting SO ₂	25
Figure 5 – Ecotech Tygon Tubing	26
Figure 6 – Opening the Instrument.....	29
Figure 7 – Instrument Back Panel	31
Figure 8 – Installation of USB Memory Stick.....	35
Figure 9 – Switching the Battery On/Off.....	36
Figure 10 – Front Panel	38
Figure 11 – Home Screen	40
Figure 12 – Communication Ports.....	63
Figure 13 – Multidrop RS232 Cable Example	64
Figure 14 – Example of Typical Network Setups	65
Figure 15 – Example of Network Menu Setup	66
Figure 16 – Port Forwarding Example	67
Figure 17 – LAN Network Set-Up (Airodis).....	67
Figure 18 – WAN Network Set-Up (Airodis)	68
Figure 19 – 25 Pin Rear Panel PCA (Default Jumpers Highlighted)	70
Figure 20 – External 25 Pin I/O Individual Pin Descriptions	71
Figure 21 – Installing Driver Software (Device Manager)	72
Figure 22 – Update Driver Popup.....	73
Figure 23 – Update Driver Popup (Directory Location).....	73
Figure 24 – Installing Driver Confirmation Prompt	74
Figure 25 – Successful Driver Installation	74
Figure 26 – Airodis Workspace Manager	76
Figure 27 – Adding a New Station	76
Figure 28 – Adding a New Station	77
Figure 29 – Station Configuration (Channel List)	78
Figure 30 – Error Status Notification.....	78
Figure 31 – Downloading Data	79
Figure 32 – Download Data Status.....	79
Figure 33 – Data Visibility.....	80
Figure 34 – Exporting Data	80
Figure 35 – Data Download Complete	81
Figure 36 – Downloading the App from Google Play Store	82
Figure 37 – Bluetooth Pairing Request.....	82
Figure 38 – Showing or Hiding the NumPad	83
Figure 39 – Switching Analysers.....	84
Figure 40 – Real-Time Plot	85
Figure 41 – Plot of Downloaded Data	86
Figure 42 – Directory Settings	87
Figure 43 – Logs Format	87
Figure 44 – Colour Theme Settings	88
Figure 45 – Example of a Calibration System	89
Figure 46 – Setting the Ambient Set Point.....	92
Figure 47 – Excel Graph of Multipoint Calibration.....	97

Figure 48 – Single High Pressure Calibration Option.....	99
Figure 49 – Dual High Pressure Calibration Option.....	101
Figure 50 – Minifit Extraction Tool – (PN: T030001).....	103
Figure 51 – Orifice/Sintered Filter Removal Tool – (PN: H010046).....	103
Figure 52 – Leak Test Jig – (PN: H050069).....	104
Figure 53 – Air Monitoring Test Equipment Kit (AMTEK) – Customisable.....	104
Figure 54 – Removing the Plunger.....	106
Figure 55 – Removing the Fan Filter.....	106
Figure 56 – DFU Filter.....	107
Figure 57 – Remove Desiccant Access Cap.....	109
Figure 58 – Zero Scrubber Removal.....	110
Figure 59 – Reaction Cell T-Piece.....	111
Figure 60 – Collets of the UV Lamp.....	112
Figure 61 – Test Point Location.....	113
Figure 62 – Typical Test Point Reading of Cell Pressure Sensor.....	114
Figure 63 – Flow Fault Diagnostic Procedure.....	121
Figure 64 – Noisy or Unstable Zero or Span Results.....	122
Figure 65 – Troubleshooting, Electronic Zero Adjust.....	123
Figure 66 – Troubleshooting, SO ₂ Reaction Cell Temperature Failure.....	124
Figure 67 – USB Memory Stick Failure.....	125
Figure 68 – USB Memory Stick File Structure.....	127
Figure 69 – Dual Filter Option Installed.....	129
Figure 70 – Separate Rack Slides.....	130
Figure 71 – Assemble Inner Slide on Chassis.....	130
Figure 72 – Rack Mount Ears Fitted to Instrument.....	131
Figure 73 – Attach Rack Mount Adaptors to Outer Slides.....	131
Figure 74 – Test Fit the Rack Slide Assembly into your Rack.....	132
Figure 75 – Attach Slides to Front of Rack.....	132
Figure 76 – Slide Clips.....	133

List of Tables

Table 1 – Manual Revision History.....	16
Table 2 – Measurements: background and sample cycles.....	37
Table 3 – Digital Output States.....	58
Table 4 – Analog Outputs.....	68
Table 5 – Setting up a New Station via Airodis.....	77
Table 6 – Maintenance Schedule.....	104
Table 7 – Zero air scrubber replacement frequency.....	110
Table 8 – Common Errors and Troubleshooting.....	117
Table 9 – Serinus Accessories Kit H010136.....	135
Table 10 – Serinus 51 Maintenance Kit - E020205.....	135
Table 11 – Serinus 51 Consumables.....	136
Table 12 – Spare Parts List Serinus 51.....	137

Table 13 – Packet Format.....	149
Table 14 – Example: Primary Gas Request.....	149
Table 15 – Example: Primary Gas Response	150
Table 16 – Example: Primary Gas Response (continued).....	150
Table 17 – List of Errors.....	150
Table 18 – Example: Get IEEE Response data	151
Table 19 – Advanced Protocol Parameter List	152
Table 20 – Bayern-Hessen Data	165
Table 21 – Block Check Operation	166
Table 22 – Status Bit Map	167
Table 23 – Failure Bit Map (Positive Logic)	168
Table 24 – Modbus Error Codes.....	171

List of Appendices

Appendix A. Advanced Protocol.....	149
A.1 Command Format	149
A.2 Commands	150
A.3 List of Parameters.....	152
Appendix B. EC9800 Protocol	163
B.1 Command Format	163
B.2 Commands	163
Appendix C. Bayern-Hessen Protocol	165
C.1 Command Format	165
C.2 Commands	166
Appendix D. ModBus Protocol	169
D.1 Command Format	169
D.2 Commands	170

Manufacturer's Statement

Thank you for selecting the Ecotech Serinus 51 Sulfur Dioxide & Hydrogen Sulfide Analyser.

The Serinus series is the next generation of Ecotech designed and manufactured gas analysers. The Serinus 51 will perform sulfur dioxide (SO₂) and hydrogen sulfide (H₂S) measurements over a range of 0-2 ppm with a lower detectable limit of 0.3 ppb.

This User Manual provides a complete product description including operating instructions, calibration and maintenance requirements for the Serinus 51. This manual is valid for the most recent version of the Serinus 51 which includes the new Auto ranging Power Supply, Main Controller PCA and Rear Panel PCA.

Reference should also be made to the relevant local standards, which should be used in conjunction with this manual. Some of these standards are listed in this manual.

If, after reading this manual you have any questions or you are still unsure or unclear on any part of the Serinus 51, please do not hesitate to contact Ecotech or your local Ecotech distributor.



Please help the environment and recycle the pages of this manual when you have finished using it.

Notice

The information contained in this manual is subject to change without notice. Ecotech reserves the right to make changes to equipment construction, design, specifications and/or procedures without notification.

Copyright © 2015. All rights reserved. Reproduction of this manual, in any form, is prohibited without the written consent of Ecotech Pty Ltd.



CAUTION

Hazardous voltages exist within the analyser. Do not remove or modify any of the internal components or electrical connections whilst the mains power is on.

Ensure the mains power lead is maintained in a safe working condition.

The analyser lid should be closed during normal operation to comply with EMC regulations.

Safety Requirements

To reduce the risk of personal injury caused by electrical shock, follow all safety notices and warnings in this documentation.

If the equipment is used for purposes not specified by Ecotech, the protection provided by this equipment may be impaired.

Replacement of any part should only be carried out by qualified personnel, using only parts specified by Ecotech as these parts meet stringent Ecotech quality assurance standards. Always disconnect power source before removing or replacing any components.

Warranty

This product has been manufactured in an ISO 9001/ISO 14001 facility with care and attention to quality.

The product is subject to a 24-month warranty on parts and labour from date of shipment. The warranty period commences when the product is shipped from the factory. Lamps, filters and other consumable items are not covered by this warranty.

Each instrument is subjected to a vigorous testing procedure prior to despatch and will be accompanied with a parameter list and a multipoint precision check thereby enabling the instrument to be installed and ready for use without any further testing.

Service and Repairs

Our qualified and experienced technicians are available to provide fast and friendly service between the hours of 8:30am – 5:00pm AEST Monday to Friday. Please contact either your local distributor or Ecotech regarding any questions you have about your instrument.

Service Guidelines

This manual is designed to provide the necessary information for the setup, operation, testing, maintenance and troubleshooting of your instrument.

Should you still require support after consulting the documentation, we encourage you to contact your local distributor for support.

To contact Ecotech directly, please e-mail our Technical Support Services group at support@ecotech.com or to speak with someone directly:

Please dial 1300 364 946 if calling from within Australia

Please dial +61 3 9730 7800 if calling from outside of Australia

Please contact Ecotech and obtain a Return Material Authorisation (RMA) number before sending any equipment back to the factory. This allows us to track and schedule service work and to expedite customer service. Please include this RMA number when you return equipment, preferably both inside and outside the shipping packaging. This will ensure you receive prompt service.

When shipping instrumentation, please also include the following information:

- Name and phone number
- Company name
- Shipping address
- Quantity of items being returned
- Model number/s or a description of each item
- Serial number/s of each item (if applicable)
- A description of the problem and any fault-finding completed
- Original sales order or invoice number related to the equipment

Shipping Address:

Attention Service Department

Ecotech Pty Ltd

1492 Ferntree Gully Road,

Knoxfield, VIC Australia 3180

CE Mark Declaration of Conformity

This declaration applies to the Serinus 51 Sulfur Dioxide & Hydrogen Sulfide Analyser as manufactured by Ecotech Pty. Ltd. of 1492 Ferntree Gully Rd, Knoxfield, VIC Australia 3180. The instrument to which this declaration relates is in conformity with the following European Union Directives:

Council Directive of 15 December 2004 on the approximation of the laws of Member States relating to electromagnetic compatibility (2004/108/EC)

The following standard was applied:

EN 61326-1:2013 Electrical equipment for measurement, control and laboratory use – EMC requirements – Part 1: General requirements.

Immunity Requirements EN 61326-1

IEC-61000-4-2 Electrostatic discharge immunity
IEC-61000-4-3 Radiated RF immunity
IEC-61000-4-4 Electrical fast transient burst immunity
IEC-61000-4-5 Surge immunity
IEC-61000-4-6 Conducted RF immunity
IEC-61000-4-11 Voltage dips and interruption immunity

Electromagnetic Compatibility EN 61326-1

CISPR-11 Radiated RF emission measurements
CISPR-11 Mains terminal RF emission measurements
IEC-61000-3-3 Mains terminal voltage fluctuation measurements
IEC-61000-3-2 Power frequency harmonic measurements

Council Directive of 12 December 2006 on the harmonisation of the laws of Member States relating to electrical equipment designed for use within certain voltage limits (2006/95/EC)

The following standard was applied:

EN 61010-1:2013 Safety requirements for electrical equipment, for measurement control and laboratory use (**3rd edition**) – Part 1: General requirements.

For protection against:

- Electric shock or burn
- Mechanical Hazards
- Excessive temperature
- Spread of fire from the equipment
- Effects of fluids and fluid pressure
- Effects of radiation, including laser sources, sonic and ultrasonic pressure
- Liberated gases, explosion and implosion

Claims for Damaged Shipments and Shipping Discrepancies

Damaged Shipments

Inspect all instruments thoroughly on receipt. Check materials in the container/s against the enclosed packing list. If the contents are damaged and/or the instrument fails to operate properly, notify the carrier and Ecotech immediately.

The following documents are necessary to support claims:

- Original freight bill and bill of lading
- Original invoice or photocopy of original invoice
- Copy of packing list
- Photographs of damaged equipment and container

You may want to keep a copy of these documents for your records.

Please refer to the instrument name, model number, serial number, sales order number and your purchase order number on all claims.

You should also:

- Contact your freight forwarder for an insurance claim
- Retain packing material for insurance inspection

Shipping Discrepancies

Check all packages against the packing list immediately on receipt. If a shortage or other discrepancy is found, notify the carrier and Ecotech immediately. Ecotech will not be responsible for shortages against the packing list unless they are reported within seven days.

Contact Details

Head Office

1492 Ferntree Gully Road, Knoxfield, VIC Australia 3180

Phone: +61 (0)3 9730 7800 Fax: +61 (0)3 9730 7899





Email: info@ecotech.com

Service: service@ecotech.com

Support: support@ecotech.com

www.ecotech.com

Internationally Recognised Symbols on Ecotech Equipment

	Protective conductor terminal	IEC 60417-5017
	Alternating current	IEC 60417-5032
	Caution, hot surface	IEC 60417-5041
	Caution, risk of danger. Refer to accompanying documents	ISO 7000-0434
	Caution, risk of electric shock	ISO 3864-5036

Manual Revision History

Manual PN: M010040
 Current revision: 3.0
 Date released: 4 February 2015
 Description: User Manual for the Serinus 51 Sulfur Dioxide & Hydrogen Sulfide Analyser

This manual is the full user manual for the Serinus 51 Sulfur Dioxide & Hydrogen Sulfide Analyser. This manual contains all relevant information on theory, specifications, installation, operation, maintenance and calibration. Any information that cannot be found within this manual can be obtained by contacting Ecotech.

This manual uses cross reference links extensively throughout this manual. The hot keys below will greatly reduce the amount of time scrolling between references:

- You can access the links by pressing the following:
 - > CTRL + LEFT MOUSE CLICK: Move to the link location
- You can switch between links by pressing the following:
 - > ALT + LEFT ARROW KEY: Returns you to previous Link
 - > ALT + RIGHT ARROW KEY: Swaps back

Table 1 – Manual Revision History

Edition	Date	Summary
1.0	October 2008	Initial release
2.0	January 2013	New Chassis Updated menu system Added Bluetooth menu Serinus Remote Android App Rack mount procedure updated Analog Output Calibration
2.1	March 2014	SO ₂ selective scrubber humidifier added
2.3	April 2014	Auto-Ranging Power Supply Added Main Controller and Rear Panel PCAs changed.
3.0	February 2015	Updated to align with V3 instrument build Addition of humidifier

1. Introduction

1.1 Description

The Serinus 51 SO₂/H₂S analyser uses UV fluorescent radiation technology to detect Sulfur Dioxide and Hydrogen Sulphide to a sensitivity of 0.5 ppb in the range of 0-2 ppm.

This section will describe the specifications of the instrument as well as the main components and techniques used to obtain stable gas concentration readings.

1.2 Specifications

1.2.1 Measurement

Range

0-2 ppm autoranging

Lower detectable limit: <0.5 ppb or 0.2 % of concentration reading, whichever is greater, with Kalman filter active

1.2.2 Precision/Accuracy

Precision

0.5 ppb or 0.15 % of reading, whichever is greater

Linearity

±1 % of full scale (from best straight-line fit)

Noise at Zero

<0.15 ppb

Response Time

60 seconds to 95 %

Sample Flow Rates

0.700 slpm H₂S Cycle

1.400 slpm SO₂ Cycle

1.2.3 Calibration

Zero Drift

Temperature dependant: 0.1 ppb per °C

24 hours: < 1.0 ppb

30 days: < 1.0 ppb

Span Drift

Temperature dependant: 0.1 % per °C

24 hours: <0.5 % of reading

30 days: <0.5 % of reading

1.2.4 Power

Operating voltage

100-240VAC, 50 to 60Hz, (autoranging)

Power Consumption

255VA max (typical at start up)

180VA after warm-up

1.2.5 Operating Conditions

Ambient Temperature Range

5 °C to 40 °C (41 °F to 104 °F)

Sample Pressure Dependence

5 % change in pressure produces less than a 1 % change in reading

Maximum altitude: 3000 m above sea level

1.2.6 Communications

Analog Output

- Menu selectable current output of 0-20 mA, 2-20 mA or 4-20 mA
- Voltage output of 0 to 5V, with menu selectable zero offset of 0 %, 5 % or 10 %
- Voltage output of 0 to 10 V, (configured using jumpers (JP3) on rear panel PCA)
- Range: 0 to full scale from 0-0.05 ppm to 0-20 ppm with 0 %, 5 % and 10 % offset

Analog Input

- Three analog voltage inputs (0-5VDC) CAT I rated

Digital Output

- RS232 port #1: Normal digital communication or termination panel connections
- RS232 port #2: Multidrop port used for multiple analyser connections on a single RS232
- USB port connection on rear panel
- 25 pin connector with discrete status and user control

- USB stick memory (front panel) for data logging, event logging and parameter storage
- Eight Digital Outputs, open collector max 400mA each @ 12VDC (max total output 2A)
- Eight Digital Inputs, 0-5VDC, CAT I rated.

1.2.7 Physical Dimensions

Case Dimensions

Rack Length (front to rear):	597 mm (23.5")
Total Length (with latch release):	638 mm (25.1")
Chassis Width:	418 mm (16.5") – (Not including humidifier bottle)
Front Panel Width:	429 mm (16.9")
Chassis Height:	163 mm/Uses 4RU (6.4")
Front Panel Height:	175 mm (6.9")
Weight:	22 kg

1.3 Nomenclature

SO ₂ :	Sulfur dioxide.
H ₂ S:	Hydrogen sulfide.
Span:	A gas sample of known composition and concentration used to calibrate/check the upper range of the instrument (sulfur dioxide).
Zero:	Zero calibration uses zero air (SO ₂ scrubbed ambient air) to calibrate/check the lower range of the instrument.
Background:	Is the reading of the sample without sulfur dioxide present in the reaction cell?
Multipoint Precision Check:	A procedure to verify the linearity of the response of the instrument.
Calibration:	The process of adjusting the instrument to ensure that it is measuring the correct concentration.
Zero Drift:	The change in instrument response to zero air over a period of continuous unadjusted operation.
Automatic Zero:	The automatic zero performs a zero check at a specified time through a 24 hour cycle which adjusts the lower limit of the instrument.
Zero Air:	Is purified air in which the concentration of SO ₂ is <0.5 ppb with water vapour of less than 10 % RH. Sufficient purified air can be obtained by passing dry ambient air through an activated charcoal filter and a particulate filter.
External Span Source:	Span gas that is delivered via an external accredited cylinder (e.g. NATA/NIST).

Sample Air:	Sample air is defined as the sample before it has entered the reaction cell, as distinguished from the exhaust air.
Exhaust Air:	Exhaust air is the sample air after it has passed through the reaction/measurement/detection cell and is moving towards being expelled from the instrument.
ID and OD:	These are measurements of tubing. ID is the internal diameter of tubing, OD is the outer diameter.
Multidrop:	A configuration of multiple instruments connected via the same RS232 cable.
Photomultiplier Tube:	A highly sensitive device which can detect extremely low levels of light (photons) and multiply the electrical signal to a point where it can be accurately measured. These are often called PMT's for short.
Bootloader:	A program that checks whether the current firmware is valid, executes the instrument start-up. The bootloader can be entered by pressing the '+' key on the keypad during the first ½ second after power on and following the prompts. The boot loader enables various low level recovery tools, including updating the main firmware from a USB stick.
PCA:	Printed Circuit Assembly. An electronic circuit mounted on a printed circuit board to perform a specific electronic function.
Slpm:	Slpm = Standard litres per minute. This is the flow referenced to standard temperature and pressure conditions. For the purposes of this manual, all flows are referenced to 0 °C and 101.3 kpa (1 atm).

1.4 Background/Theory

Sulfur Dioxide

Sulfur dioxide is the product of the combustion of sulfur compounds and causes significant environmental pollution. The main sources of SO₂ in the environment are from various industrial processes such as the burning of coal in power stations, the extraction of metals from ore and combustion of fuel within automobiles.

Sulfur dioxide is a noxious gas that can cause respiratory damage as well as impairing visibility when in high concentrations. Sulfur dioxide also has the potential to form acid rain (H₂SO₄) which causes health, environmental and infrastructural damage.

Hydrogen Sulphide

Hydrogen sulfide is created through industrial processes. The main sources of anthropogenic hydrogen sulfide (H₂S) emissions are from petroleum refineries, paper mills, coke ovens (aluminum, steel, graphite, electrical and construction industries) and to a smaller extent tanneries.

Hydrogen sulfide is toxic to many parts of the human body; it affects the nervous system most acutely and also inhibits respiration. General harmful levels of Hydrogen sulfide (H₂S) exposures are 5-10 ppm; symptoms caused by H₂S levels above this begin with eye irritation and lead up to death.

1.4.1 Measurement Theory - Sulfur Dioxide

The measurement of sulfur dioxide is based on classical fluorescence spectroscopy principles. Sulfur dioxide (SO₂) exhibits a strong ultraviolet (UV) absorption spectrum between 200 and 240nm. When SO₂ absorbs UV at this wavelength, photon emission occurs (300-420nm). The amount of fluorescence emitted is directly proportional to the SO₂ concentration.

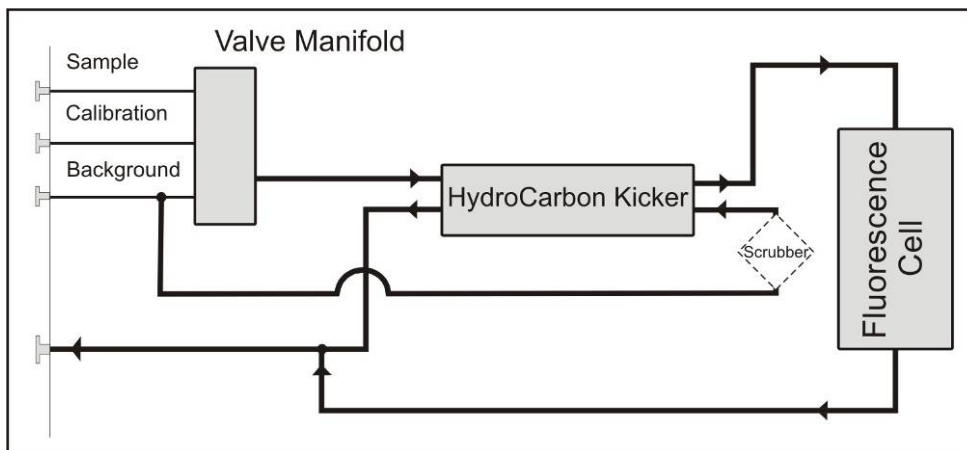

Figure 1 – Simple Pneumatic Diagram

The Serinus 51 follows these principles and measurement techniques:

- Sample air is passed through a hydrocarbon kicker which removes hydrocarbons (a common interferent).
- UV energy from a zinc discharge lamp is passed through a UV band pass filter to produce radiation at 214nm.
- The radiation is focused into the fluorescence cell where it is absorbed by the SO₂ molecules.
- The SO₂ molecules emit photons (fluoresce) uniformly in all directions.
- Wavelengths between 310-350nm, which are specific to SO₂, pass through a band pass filter where they reach the photomultiplier tube which measures the signal intensity.
- A reference detector monitors the emission from the zinc lamp and is used to correct for fluctuations in lamp intensity.

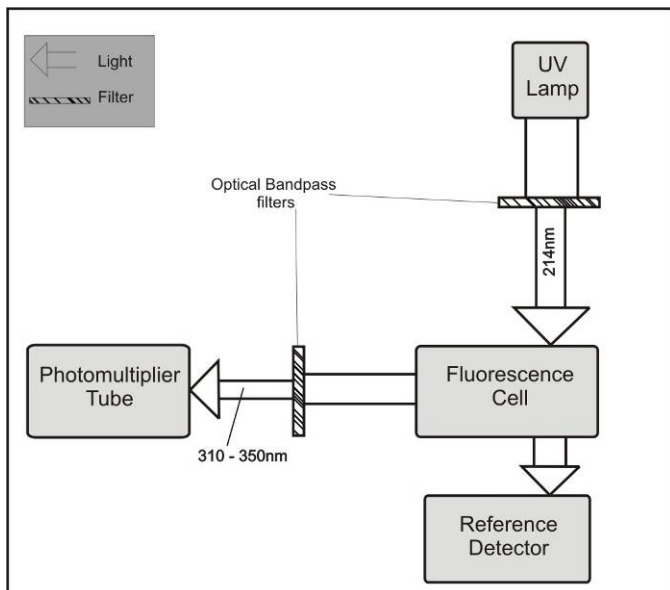

Figure 2 – Optical Measurement Theory

1.4.2 Measurement Theory - Hydrogen Sulphide

H₂S is measured by first scrubbing the SO₂ out of the sample with a selective SO₂ scrubber and converting the remaining H₂S into SO₂ with a thermal converter. The sample is drawn into the reaction cell where it is measured as SO₂ using the method outlined above.

1.4.3 Kalman Filter Theory

The digital Kalman filter provides an ideal compromise between response time and noise reduction for the type of signal and noise present in ambient air analysers.

The Kalman filter enhances measurements by modifying the filter time base variable, depending on the change rate of the measured value. If the signal is changing rapidly, the instrument is allowed to respond quickly. When the signal is steady, a long integration time is used to reduce noise. The system continuously analyses the signal and uses the appropriate filtering time.

1.5 Instrument Description

The major components of the Serinus 51 are described below:

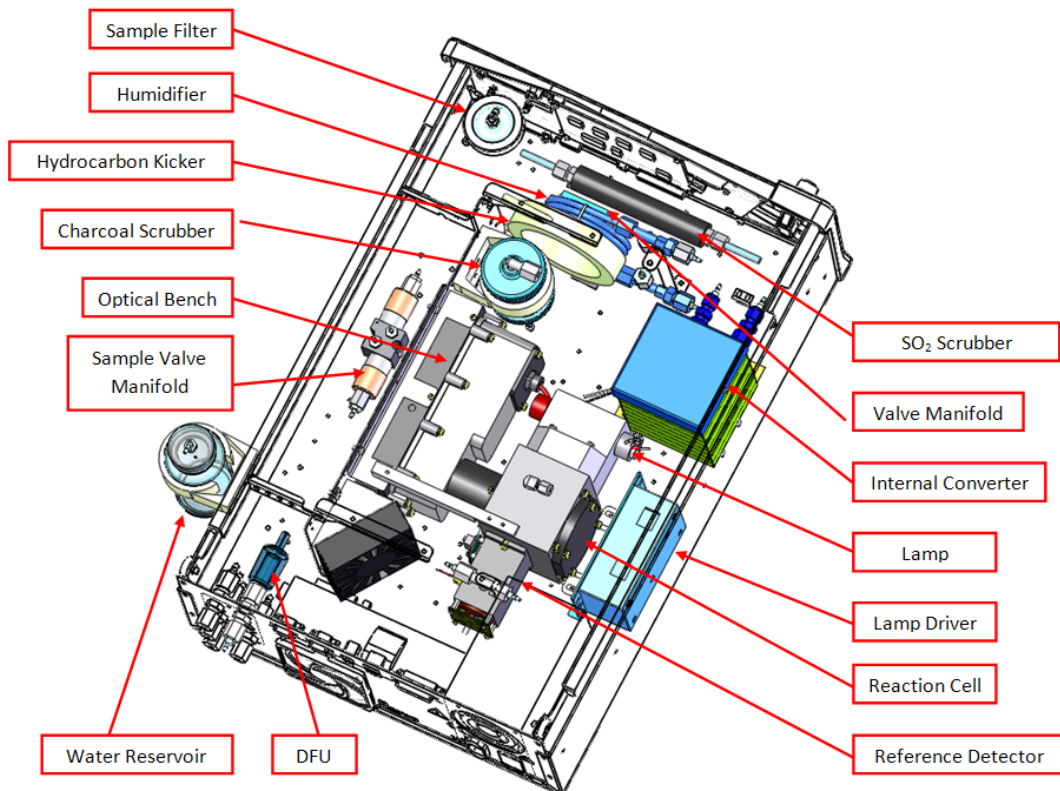

Figure 3 – Major Components

1.5.1 Calibration Valve Manifold

The calibration valve manifold switches between sample, calibration and background gas.

1.5.2 Particulate Filter

The particulate filter is a Teflon 5 micron (μm) filter with a diameter of 47mm. This filter eliminates all particles larger than $5\mu\text{m}$ that could interfere with sample measurement.

1.5.3 Hydrocarbon Kicker

The hydrocarbon kicker removes interfering hydrocarbons from the sample air. This is achieved by using counter current exchange, where an air with a lower concentration of hydrocarbons moves in an opposite direction to air with a higher concentration. The high concentrations of hydrocarbons diffuse through a selective permeation membrane to the low concentration exhaust air and are removed. Increasing the flow of the low concentration air also increase the rate of diffusion.

1.5.4 Zero Air Scrubber

A charcoal scrubber creates H₂S and SO₂ free air which is used to provide background corrections and in the hydrocarbon kicker to remove hydrocarbons from sample air.

1.5.5 Reaction Cell

UV Lamp

The UV lamp is a discharge zinc lamp which emits UV radiation over a broad range.

UV Band Pass Filter

The band pass filter only allows UV at 214nm through into the cell.

Optical Band Pass Filter

The optical band pass filter is a coloured glass that only allows light of a specific wavelength through to the PMT (310 to 350nm).

UV Grade Lenses

Two UV grade silica lenses are used in the optical path, the first (plano-convex) to focus UV radiation inside the reaction cell and the second (bi-convex) focuses the fluorescent light onto the PMT cathode from the SO₂ reactions.

UV Reference Detector & Preamplifier

The UV reference detector monitors the intensity of UV radiation entering the reaction cell. This measurement is used to compensate for variations in UV lamp output. The preamplifier circuit board converts the current signal from reference detector to a voltage signal and provides amplification.

1.5.6 Optical Bench

Photomultiplier Tube

The PMT measures the amount of light reaching it. The filtering of light reaching the PMT allows direct measurement of SO₂ in the reaction cell.

PMT High Voltage Supply and Preamplifier

This is a single component within the PMT housing. Its function is to supply high voltage to the PMT and to amplify the photocurrent signal from the PMT.

PMT Cooler

The PMT cooler ensures that the PMT is operated at a constant 13 °C. This reduces the measurement noise of the PMT.

1.5.7 Selective SO₂ Scrubber

The Sulfur Dioxide scrubber is a selective scrubber that captures SO₂ but allows H₂S to continue through to the internal converter.

1.5.8 SO₂ Humidifier

The lifespan of the Selective Sulfur Dioxide scrubber is significantly extended by humidifying the sample before it passes through. The humidification achieved by a permeable membrane which only allows water vapor to pass from a cross-flow of high humidity (called the sheath flow) which is drawn from an external high humidity source (the air entering water reservoir), to the low humidity flow (the sample flow). No contaminants or gas can pass through this membrane.

1.5.9 Internal Converter

The internal converter uses high temperatures (300 °C) and a catalyst to convert any H₂S in the sample to SO₂. This conversion is used for H₂S measurements, on sample air which has previously had the SO₂ portion scrubbed from it.

1.5.10 Lamp Driver PCA

The lamp driver PCA generates a high voltage (800 to 1100 V), high frequency voltage to start and maintain the UV lamp at a constant intensity. The lamp current is set by the Instrument and is maintained at 35 mA.



CAUTION

The lamp driver PCA contains high voltages. Ensure instrument is turned off before accessing this component.

Note: The lamp driver PCA is the same type as used on the Serinus 10 Ozone Analyser. Switch S1 on the lamp driver PCA sets the lamp type for which the driver is to be used. The correct setting must be used or damage to the electronics may occur. For the Serinus 51 (which measures SO₂), switches 1 & 2 must be in the “ON” position and switches 3 & 4 must be in the “OFF” position (refer to Figure 4 – Lamp Type Switch Setting)

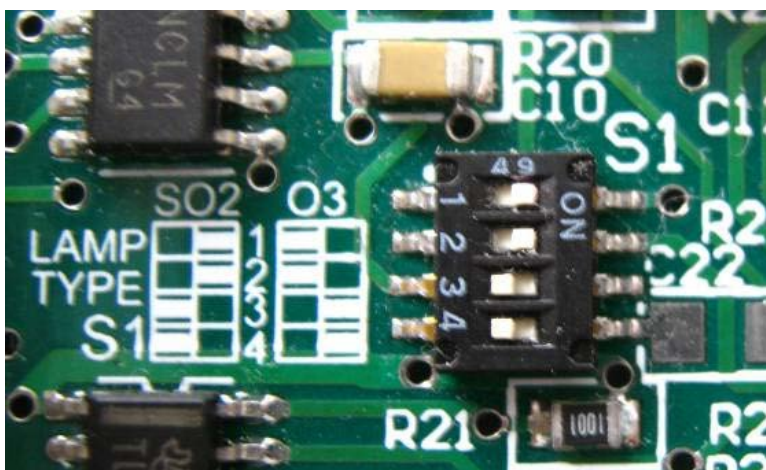

Figure 4 – Lamp Type Switch Setting SO₂

1.5.11 Pressure Sensor PCA

An absolute-pressure transducer is mounted on the reaction cell and used to measure the sample pressure in the reaction cell. This pressure is used to check for flow and correct readings for pressure variations.

1.5.12 Pneumatic Tubing

The pneumatic tubing inside this instrument is specially designed for use in Ecotech Serinus instruments. It has the flexibility of Tygon tubing with the added inner sheath of Teflon to prevent contamination of the sample. Care should be taken when removing and inserting the tubing into the barbed fittings.



Figure 5 – Ecotech Tygon Tubing

1.5.13 Main Controller PCA

The main controller PCA controls all the processes within the instrument. As well as the on-board microprocessor, it contains a battery backed clock, calendar, analog to digital converters and many other circuits for signal processing and control. The ambient pressure and chassis temperature sensors are also located on this board. The main controller PCA is located above all other components within the instrument. It pivots on hinges to allow access to the components underneath. The current revision of the main controller PCA for which this manual applies, has many differences to previous revisions, highlighted by the many vacant component locations on the PCA.



CAUTION

Never place objects on top of the main controller PCA as it may result in damage.

1.5.14 Power Supply

The power supply is a self-contained unit housed in a steel case designed to meet all the relevant safety and EMC requirements. This new revision of power supply is different to the previous revision as there is no need to set the operating voltage switch because it is autoranging.

The output of the power supply provides +12V, +5V, -12V and +3.3V to the instrument.

1.5.15 On/Off Switch

The on/off switch is located on the back panel (bottom right facing the rear of the instrument). It is part of the power supply.

1.5.16 Communications

Communication between the instrument and either a data logger, laptop or network can be performed with the following communication connections located on the back panel (refer to Figure 7). These connections can be used for downloading data, onsite diagnostics, maintenance and firmware upgrades.

RS232 #1

This port is designed to be used for simple RS232 communication.

RS232 #2

This port is designed to be used for simple RS232 communication or in multidrop configuration.

USB

This port can be used for instrument communications with equipment through a standard USB port.

TCP/IP (optional)

This port is best used for remote access and real-time access to instruments when a network is available to connect with.

External I/O Port

The analog/digital port sends and receives analog/digital signals to other devices. These signals are commonly used to activate gas calibrators or for warning alarms.

Analog Outputs

The instrument is equipped with a maximum of three analog outputs for each measured gas. The outputs are menu selectable; voltage output (0-5VDC) or current output (0-20, 2-20 or 4-20mA). The current output can also be configured as a voltage output of 0 to 10V, by configuring the jumpers (JP3) on the rear panel PCA.

Analog Inputs

The instrument is also equipped with three analog voltage inputs (0-5VDC CAT 1) with resolution of 15 bits plus polarity.



CAUTION

Exceeding these voltages can permanently damage the instrument and void the warranty.

Digital Status Inputs

The instrument is equipped with eight logic level inputs (0–5VDC CAT 1) for the external control of zero/span calibration sequences.



CAUTION

Exceeding these voltages can permanently damage the instrument and void the warranty.

Digital Status Outputs

The instrument is equipped with eight open collector outputs which will convey instrument status conditions and warning alarms such as no flow, sample mode, etc.



CAUTION

Exceeding 12VDC or drawing greater than 400mA on a single output or a total greater than 2A across the eight outputs can permanently damage the instrument and void the warranty.

Bluetooth

This allows for remote access of the instrument to any Android device with the Serinus remote application installed. It uses Bluetooth to control the instrument, view parameters, download data and construct real-time graphs.

2. Installation

2.1 Initial Check

Packaging

The Serinus 51 is transported in packaging specifically designed to minimise the effects of shock and vibration during transportation. Ecotech recommends that the packaging be kept if there is a likelihood that the instrument is going to be relocated.

Note: The red plastic caps that seal the pneumatic connections during transport must be removed prior to operation.

Opening the Instrument

Check the interior of the instrument with the following steps:

1. Undo the screws located in the rear panel.
2. Open the chassis lid by releasing the latch (pressing the button) located on the front panel in the top left-hand corner, slide the lid backwards.
3. To completely remove, slide the lid backwards until the rollers line up with the gaps in the track and pull the lid upwards to remove from the instrument (refer to Figure 6).
4. Check that all pneumatic and electrical connectors are connected. If not, reconnect.
5. Check for any visible and obvious damage. If damage exists contact your supplier and follow the instructions in (Claims for Damaged Shipments) and (Shipping Discrepancies) at the front of this manual.

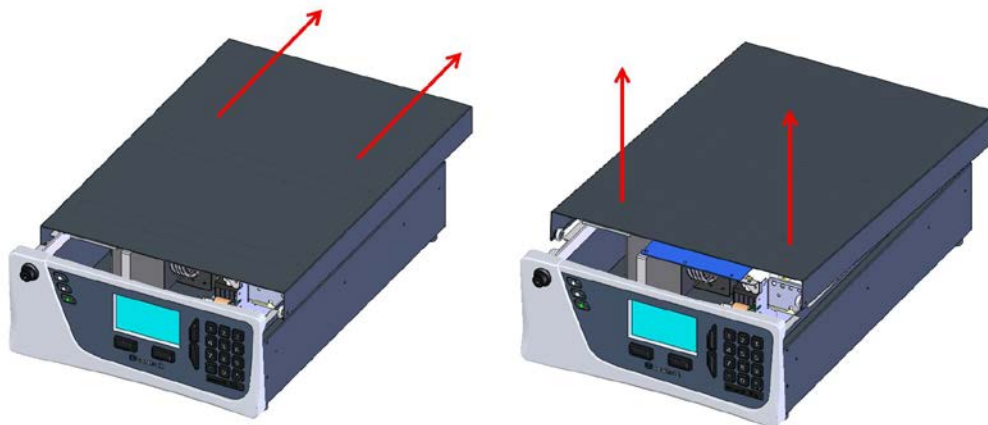

Figure 6 – Opening the Instrument

Items Received

With the delivery of the Serinus 51, you should have received the following:

- Ecotech Serinus 51 analyser PN: E020051
- Humidifier Bottle Assembly PN: H012155
- Green Ecotech Resources USB Stick PN: H030137-01
- End Caps PN: B010002
- Manual PN: M010028 (hardcopy optional)
- USB Memory Stick PN: H030021
- USB Cable PN: COM-1440
- Power Lead (120V)* USA PN: C040007
- Power Lead (240V)* Australia PN: C040009
- Europe PN: C040008
- UK PN: C040010

*The power lead received depends on the mains supply of the country (120 V or 240 V).

Note: Check that all these items have been delivered undamaged. If any item appears damaged, please contact your supplier before turning the instrument on.

2.2 Installation Notes

When installing the instrument the following points must be taken into account:

- The instrument should be placed in an environment with minimal dust, moisture and variation in temperature.
- For best results the instrument should be located in a temperature and humidity controlled environment (air conditioned shelter). An enclosure temperature of 25-27 °C is optimum.
- Whether in a rack or placed on a bench, the instrument should not have anything placed on top of it or touching the case.
- Instruments should be sited with easy access to the front panel (instrument screen/USB memory stick) and to the back panel (communication ports/pneumatic connections).
- It is recommended that the sample line be as short as possible and/or a heated manifold be used for sampling (minimising moisture condensation in the sample).
- Install the humidifier bottle clamp (supplied with instrument) on the side of the instrument using the screw supplied. Fill the bottle with 250mL of water and secure in the clamp. Connect the humidifier bottle with the Aux In port using the supplied tubing. If the instrument is rack mounted, the humidifier bottle clamp can be attached to the rack.
- Ensure the bottle is mounted upright to prevent water being drawn into the instrument.

- Do not pressurise the sample line under any circumstances. Sample should be drawn through the instrument under atmospheric pressure. This should be achieved by using an external vacuum pump connected to the exhaust port of the instrument.
- When supplying span gas, ensure the flow is approximately 2.0 slpm and excess is sufficiently vented.

Note: The power on/off switch is accessible from the rear of the instrument only. Install the instrument so that the on/off power switch is accessible.

2.3 Instrument Set-up

After installing the instrument the following procedures should be followed to ready the instrument for monitoring.

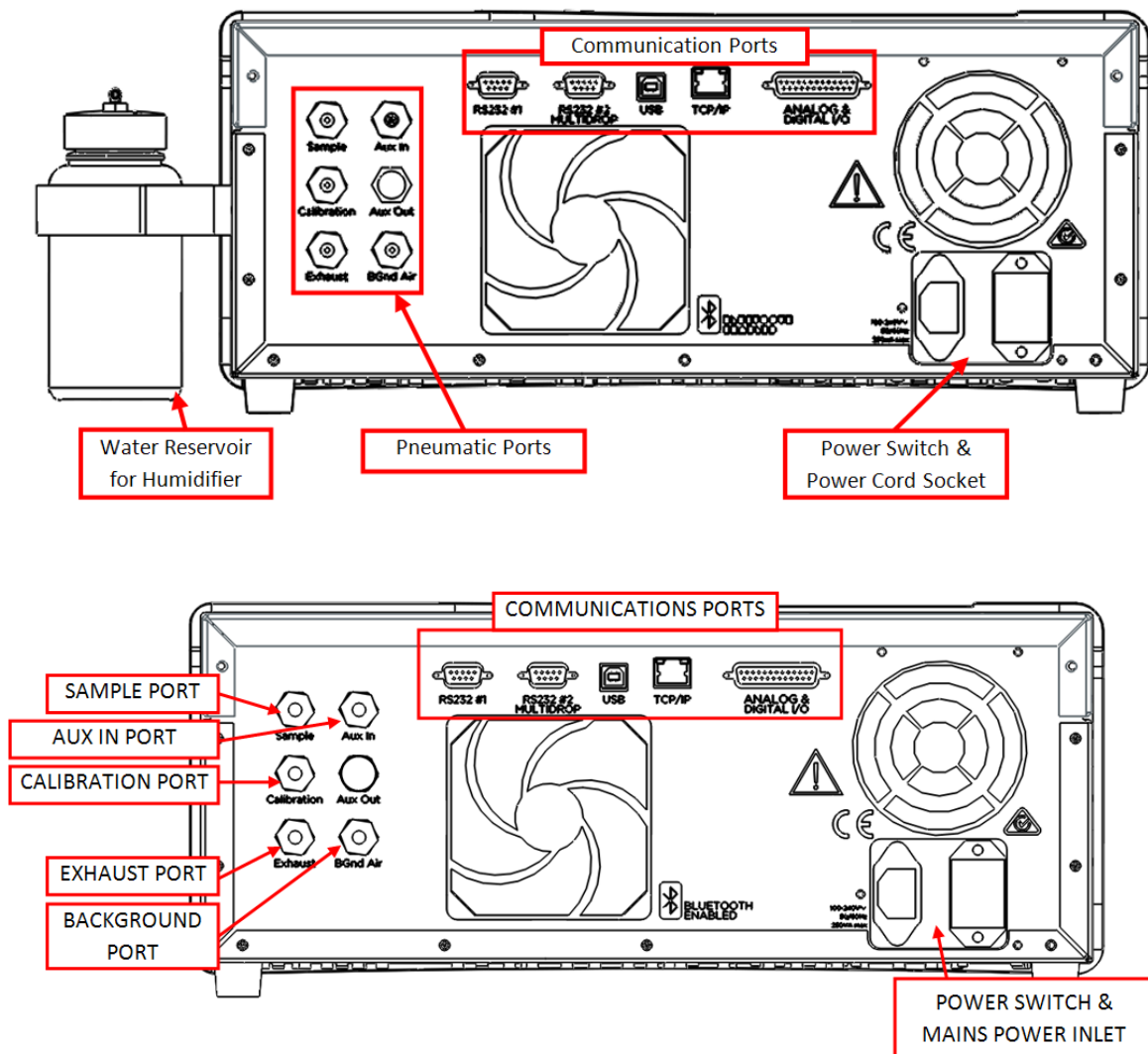

Figure 7 – Instrument Back Panel

2.3.1 Pneumatic Connections

The Serinus 51 has five pneumatic ports on the back panel of the instrument; the Sample Port, the Calibration Port, the Exhaust Port, the Background Air Port and the Auxiliary In Port. All tubing and fittings used should follow the instructions below:

- Must be made of Teflon® FEP material, Kynar®, stainless steel, glass or any other suitably inert material.
- Sample line should be no more than two meters in length with ⅛ inch ID and ¼ inch OD.
- Sample inlet pressure should not exceed 5 kPa above ambient pressure.
- Tubing must be cut squarely and any burrs removed.
- Remove the inlet port nut and insert the tubing through the back of the nut with the tube extending one inch through the front.
- Place the tubing into the port until it hits the tube stop located inside the fitting.
- Place the nut back onto the fitting and tighten clockwise until finger tight.
- Nuts should be re-tightened when instrument reaches operating temperature.

Sample Port

The sample port must be connected to an ambient source of sample air. When using a sample manifold the Serinus requires at least 2.0 slpm delivered to the sample manifold (1.4 slpm for measurement plus approximately 50 % excess).

Calibration Port

The calibration port can be connected to the span/zero sources. It is recommended that a gas calibrator (Ecotech's Serinus Cal 1000) be used with a cylinder of sulfur dioxide to deliver precise concentrations of SO₂.

Note: All connections to this port should not exceed ambient pressure. A vent is required for excess span gas.

Exhaust Port

The exhaust port is where the measured sample, calibration gas and background air are exhausted from the instrument. The exhaust port should be connected to the vacuum pump using ¼" OD tubing. The P030004 240V vacuum pump (P030005 110V) available from Ecotech, should be used to provide the required vacuum and flow for one Serinus 51 analyser as well as two other instruments such as a Serinus 10 or Serinus 30.



CAUTION

Sulfur dioxide is a toxic gas. It is recommended that exhaust air is expelled into an unoccupied area, as it contains trace levels of sulfur dioxide. The exhaust must be a suitable distance from the sample inlet to avoid influencing the ambient measurements.

Background Port

The background port is used to supply zero air to the instrument. The internal zero air scrubber is usually sufficient for this purpose. This is used for backgrounds and internal zero calibration.

Auxiliary In port

The auxiliary in port must be connected to the water reservoir via the supplied tubing after installation. This line provides humidified air which humidifies the sample gas before it goes through the SO₂ scrubber.

2.3.2 Power Connections



CAUTION

When connecting the mains power to the instrument, the following must be adhered to otherwise the safety and the reliability of the instrument may be compromised.

- A three pin mains power lead with a protective earth conductor **MUST** be used.
- The mains power outlet (wall socket) must be in the range of 100-240 VAC, 50 to 60 Hz.
- The mains power outlet must be protected by an earth leakage protection circuit.
- Connect the instruments power lead into the mains power outlet and turn the power switch on.

2.3.3 Communications Connections

There are a number of ways to communicate with the instrument. Use the supplied Airodis software to access the instrument and download data. The Airodis software is supplied on the green Ecotech resources USB stick provided with this instrument.

RS232 #1

Connect this port to a data logger (such as WinAQMS) with an RS232 cable.

RS232 #2

Connect the RS232 cable from the instrument to a computer or data logger in a multidrop formation.

Note: When using multidrop ensure each instrument is given a unique **Serial ID**.

USB

Connect a standard type B USB cable (supplied with the instrument) to this port.

TCP/IP (optional)

Plug in an ethernet cable (this cable should be attached to a network).

Analog/Digital

This port is used to send and receive analog and digital signals. It is normally used to connect with a gas calibrator or to activate alarm signals.

Each instrument contains eight digital inputs, eight digital outputs, three analog inputs and three analog outputs.

Bluetooth

Connection is enabled using Ecotech's Serinus Remote Android Application.

Use the Serinus Remote Android Application to access instrument and download data. It is available for download directly from the Google Play Store. Search for "Ecotech Serinus Remote".

2.3.4 Instrument Set-up

1. Open the lid and ensure the USB memory stick is installed (refer to Figure 8).
2. Check the battery is turned on at the main controller PCA (refer to Figure 9).
3. Turn on the instrument and allow the warm-up procedure to complete (refer to Section 3.1).
4. Set the time and date (refer to Section 3.4.8).
5. Set the digital filter to the desired setting (refer to Section 3.4.9).
6. Set the internal data logging options (refer to Section 3.4.21).
7. Set the analog/digital inputs and outputs settings (refer to Section 3.4.25).
8. Fill the water reservoir and connect the tubing between it and the Aux In port.
9. Perform a pressure sensor check (refer to Section 6.3.10).
10. Perform a leak check (refer to Section 6.3.4).
11. Leave the instrument to warm-up and stabilise for two-three hours.
12. Follow the procedure for a multipoint precision check (refer to Section 5.5).
13. The instrument is now ready for operation.

2.4 Transporting/Storage

Transporting the Serinus should be done with great care. It is recommended that the packaging the Serinus was delivered in should be used when transporting or storing the instrument.

When transporting or storing the instrument the following points should be followed:

1. Turn off the instrument and allow it to cool down.
2. Remove all pneumatic, power and communication connections.
3. Remove the water reservoir and ensure it is empty.
4. If storing over a long period (six months) turn the battery off by the switch on the main controller PCA (refer to Figure 9).
5. Remove the instrument from the rack.

6. Replace the red plugs into the pneumatic connections.
7. Remove the USB memory stick and pack with instrument (refer to Figure 8)
8. Place the instrument back into a plastic bag with desiccant packs and seal the bag (ideally the bag supplied upon delivery).
9. Place the instrument back into the original foam and box it was delivered in. If this is no longer available find some equivalent packaging which provides protection from damage.
10. The instrument is now ready for long term storage or transportation.

Note: After transport or storage the instrument must be set up and calibrated (refer to Section 2.3.4).

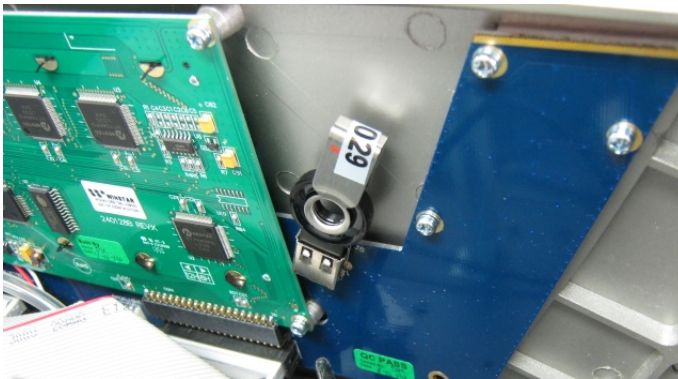

Figure 8 – Installation of USB Memory Stick

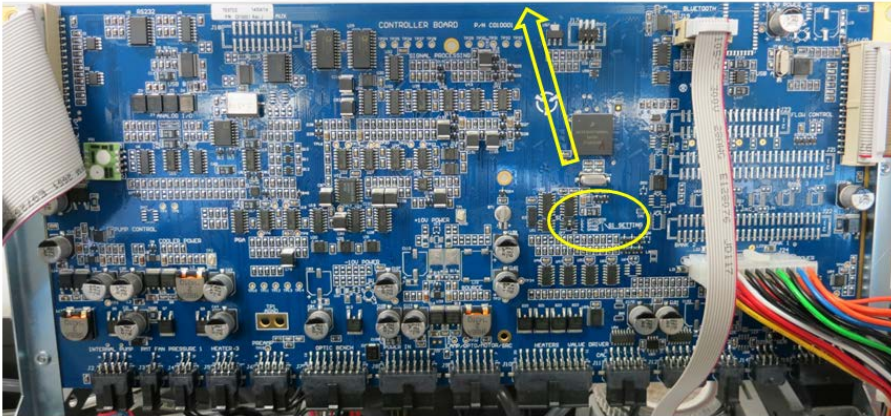

Figure 9 – Switching the Battery On/Off

3. Operation

3.1 Warm-Up

When the instrument is first turned on it must go through a period of adjustment and calibration. No measurements are taken during this warm-up period.

The following activities occur during warm-up:

High Volt Check

The high volt checks to see if the flag to run the high voltage tuning is active.

High Volt Adjust

The high voltage digital pot is adjusted to set the high voltage supply to the PMT for optimal range and performance.

Lamp Stabilise

Adjusts the lamp current to 35mA and waits for the output to stabilise.

Ref Stabilise

The instrument adjusts the reference voltage to between 2.3 and 2.7 V and waits for the reference voltage signal to stabilise.

After this warm-up has completed the instrument will immediately begin making measurements (refer to Section 3.2).

3.2 Measurement

The Serinus 51 primarily operates in two continuous cycles; the sample cycle for each gas and a background. A background is performed after warm-up and once a day at 23:50. It is used to measure background fluorescence in the reaction cell and is subtracted from sample measurements.

The Sample Meas time for both SO₂ and H₂S can be adjusted on the **Measurement Settings** (refer to Section 3.4.9).

Table 2 – Measurements: background and sample cycles

Instrument State	Duration (minutes)	Description
Bkgnd Fill	4	Reaction cell fills with background air
Bkgnd Meas	5	Measurement of background air
SO ₂ Sample Fill	3	Reaction cell fills with SO ₂ sample air
SO ₂ Sample Meas	5	Measurement of SO ₂ sample air
H ₂ S Sample Fill	3	Reaction cell fills with H ₂ S sample air
H ₂ S Sample Meas	5	Measurement of H ₂ S sample air

3.3 General Operation Information

3.3.1 Keypad & Display

The Serinus is operated with the use of four sets of buttons:

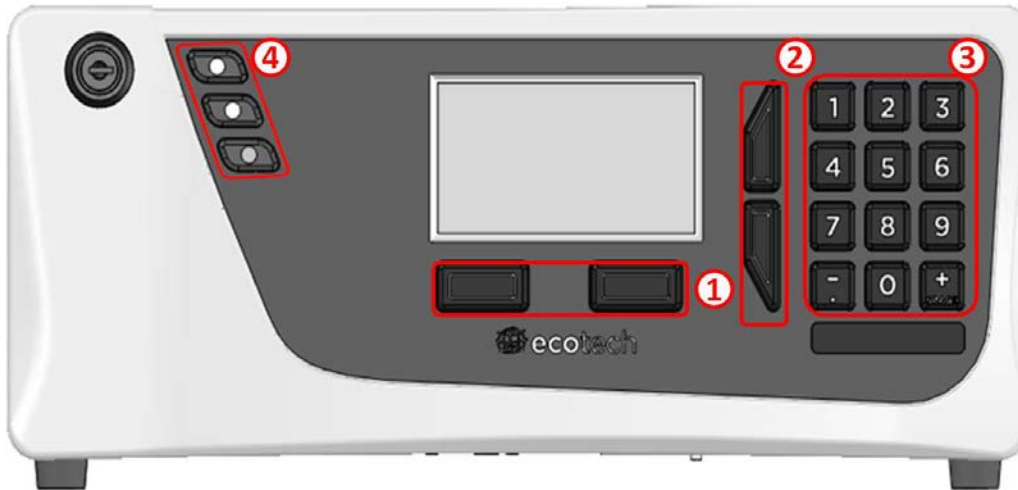

Figure 10 – Front Panel

Selection Buttons (1)

The selection buttons will perform the function specified directly above it on the screen. Generally this involves opening a menu, editing a value, accepting or cancelling an edit or starting an operation.

Scrolling Buttons (2)

The scrolling buttons allow users to scroll up and down through menus or selection boxes. The scrolling buttons are also used to scroll side to side through editable fields such as: Dates, Times, Numbers etc.

On the home screen these buttons are used for adjusting the screen contrast. Press and hold the up button to increase contrast; press and hold the down button to decrease.

Keypad (3)

The keypad contains the numbers 0-9, a decimal point/minus key (.) and a space/plus key (SPACE).

In the few cases where letters can be entered, the number keys act like a telephone keypad. Every time a number key is pressed, it cycles through its choices. The up/down arrow keys scroll through all the numbers and the entire alphabet.

1 = 1 or space

2 = 2, A, B, C, a, b, c

3 = 3, D, E, F, d, e, f

4 = 4, G, H, I, g, h, i

5 = 5, J, K, L, j, k, l

6 = 6, M, N, O, m, n, o

7 = 7, P, Q, R, S, p, q, r, s

8 = 8, T, U, V, t, u, v

9 = 9, W, X, Y, Z, w, x, y, z

0 = 0 or space

The ($\overset{+}{\text{SPACE}}$) and key ($\bar{\cdot}$) button functions depend on context. When editing a floating point number, the key ($\bar{\cdot}$) inserts a negative sign if the editing cursor is at the start of the number and negative signs are allowed. Otherwise it moves the decimal place to the current cursor location. The ($\overset{+}{\text{SPACE}}$) key inserts a positive sign if the cursor is at the start of the number; otherwise it enters a space. For non-floating point numbers, these keys usually increment or decrement the current value by 1. When editing the month field of a date, the ($\overset{+}{\text{SPACE}}$) and ($\bar{\cdot}$) key change the month.

Instrument Status Light Buttons (4)

Located in the top left corner, these lights indicate the status of the instrument as a whole.

- A red light indicates that the instrument has a major failure and is not functioning.
- An orange light indicates there is a minor problem with the instrument, but the instrument may still take measurements reliably.
- A green light indicates that the instrument is working and there are no problems.

In the case of an orange or red light enter the Status Menu to find which components are failing (refer to Section 3.4.4) or pressing the orange or red light when illuminated will bring up a pop up box with a full list of current faults.

Pressing the green status light button at any time will cancel any open edit box or menu and return the user to the home screen.

If no instrument status lights are on and the keypad is backlit, this indicates that the instrument is running the bootloader. The screen will also indicate that it is in the bootloader menu.

3.3.2 Main Display

The home screen is composed of seven parts: readings (1), error/status line (2), instrument activity line (3), selection buttons (4), time/date (5), concentration units (6) and USB status (7).

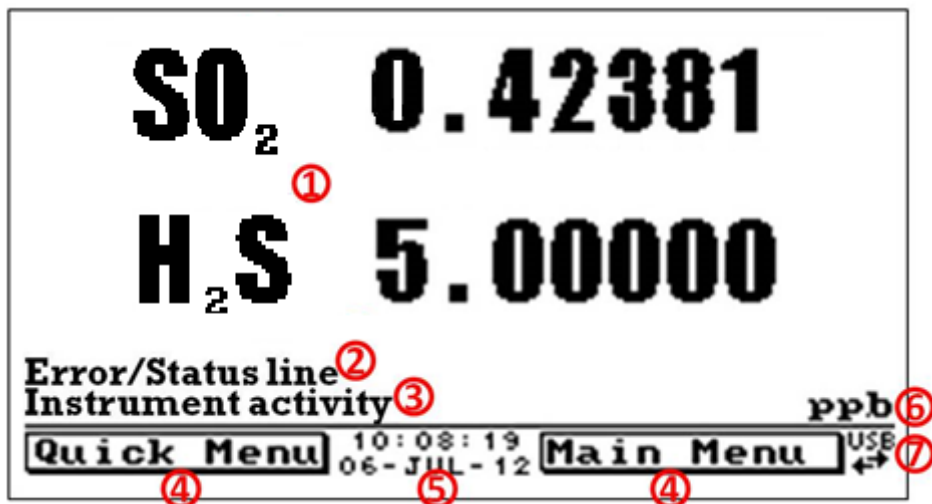

Figure 11 – Home Screen

Readings (1)

Displays the concentration being measured in real-time. The display can be configured to show just the instantaneous data or the instantaneous and average data (refer to Section 3.4.8).

Error/Status Line (2)

The error/status line provides users with information on any problems the instrument may have. It displays the highest priority error or status condition contained in the **Status Menu** (refer to Section 3.4.4).

Instrument Activity (3)

This line shows what function the instrument is currently performing. Generally, it will show three groups of actions: Warm-up, Measurement or Calibration.

Selection Buttons (4)

These buttons are used on the home screen to enter one of two menus. The **Quick Menu** (refer to Section 3.4.1) contains all information and features necessary for scheduled maintenance. The **Main Menu** (refer to Section 3.4.2) contains all information and fields available to users and is generally only used during initial set-up and diagnostics.

Time and Date (5)

The time and date are displayed in between the menu buttons at the bottom of the screen.

Concentration Units (6)

The instrument units are displayed in the bottom right hand corner of the display.

USB Detection (7)

A USB symbol will be displayed in the bottom right corner when the USB memory stick is plugged in (the USB socket is behind the front panel). If the USB symbol is not shown the USB memory stick should be inserted. Underneath the USB symbol arrows may be displayed which indicates data transfer. The USB memory stick must not be removed whilst the arrows are visible.

Note: To safely remove the USB memory stick, navigate to the **Quick Menu** and use the **Safely Remove USB Stick** function (refer to Section 3.4.1).

3.4 Menus & Screens

The menu system is divided into two sections, the **Quick Menu** and the **Main Menu** electable from the **Home Screen**. The **Quick Menu** contains all information and operations necessary during scheduled maintenance visits. The **Main Menu** contains all fields that are accessible to users. It provides information on component failures and measurement parameters as well as editable fields and test procedures.

In general, editable parameters are displayed in bold font. Non-editable information is displayed in a thin font. Some parameters may become editable based on the state of the instrument.

For example, the manual calibration type and mode can only be changed when the instrument has finished the warm-up process.

3.4.1 Quick Menu

The **Quick Menu** contains all the maintenance tools in one easy to use screen. It allows operators to perform calibrations, check important parameters and review the service history.

Span Calibrate SO₂

This field is used to perform a span calibration and should be only used when a known concentration of span gas is running through the reaction cell and the reading is stable.

Activating the span calibrate field for a named gas will open a dialog box. Enter the concentration of the span gas that the instrument is sampling and press **Accept**.

Event Log

This field enters a screen with a log of all the events that the instrument has performed. These events include errors and warnings. This log is stored on the removable USB memory stick.

The log is organised by month. When you enter this screen you will be prompted to enter the month for which you wish to view events.

Instrument

This field allows the instrument to be set to either **Online** (normal instrument operation) or **In Maintenance** (data is flagged as invalid).

Safely Remove USB Stick	Always select this menu item before removing the USB memory stick or select the same menu item from the Service Menu (refer to Section 3.4.12). Failure to do this may cause corruption of the memory stick.
Gas to Measure	This field allows the user to select whether the instrument will only measure SO₂ , only measure H₂S or measure Both SO ₂ and H ₂ S.
Instrument Gain	This is a multiplication factor which is used to adjust the concentration measurement to the appropriate level (set by performing a Span Calibrate). This should be recorded after each calibration in the station log book.
Next Service Due	A field that notifies the user when the next instrument service is due. This value is editable in the Next Service Due field of the Service Menu (refer to Section 3.4.12). This field is only displayed in the two weeks prior to the date displayed in this field or after the date has occurred.

3.4.2 Main Menu

Main Menu

There are six menus on the **Main Menu** screen.

Analyser State Menu	Refer to Section 3.4.3.
General Settings Menu	Refer to Section 3.4.8.
Measurement Settings Menu	Refer to Section 3.4.9.
Calibration Menu	Refer to Section 3.4.10.
Service Menu	Refer to Section 3.4.12.
Communications Menu	Refer to Section 3.4.20.

3.4.3 Analyser State Menu

Main Menu → Analyser State Menu

This displays the status of various parameters that affect instrument measurements.

Status Menu	Refer to Section 3.4.4.
Temperature Menu	Refer to Section 3.4.5.
Pressure & Flow Menu	Refer to Section 3.4.6.
Voltage Menu	Refer to Section 3.4.7.
Model	This field will always display Serinus.
Variant	The variant of the Serinus model (e.g. S51).
Range	The range of the Serinus model (Standard, High or Trace).
Ecotech ID	The Ecotech ID number.
Serial No.	The main controller PCA serial number.

Board Revision	The main controller PCA version.
Firmware Ver.	This field displays the firmware version currently in use on this instrument. This can be important when performing diagnostics and reporting back to the manufacturer.
Power Failure	This field displays the time and date of the last power failure or when power was disconnected from the instrument.

3.4.4 Status Menu

Main Menu → Analyser State Menu → Status Menu

The **Status Menu** presents a list of the current **Pass/Fail** statuses of the main components. During warm-up, the status of some parameters will be a dashed line.

Event Log	This field enters a screen with a log of all the events that the instrument has performed. These events include errors and warnings. This log is stored on the USB memory stick. The log is organised by month. When you enter this screen you will be prompted to enter the month for which you wish to view events.
Show Error List	This field allows the user to display the list of current errors and warnings on the screen.
Next Service Due	This field is visible with the next service due date if the service is due within the next two weeks.
+5V Supply	Pass if the +5 V power supply is within the acceptable range.
+12V Supply	Pass if the +12 V power supply is within the acceptable range.
+ Analog Supply	Pass if the analog power supply is within the acceptable range (+12 V).
- Analog Supply	Pass if the analog power supply is within the acceptable range (-12 V).
A2D	Fail only if a problem is detected with the analog to digital conversion.
Cell Temp.	Pass if the cell heater temperature is within $\pm 10\%$ of the heater set point (refer to Section 3.4.5).
Converter Temp.	Temperature of the H ₂ S to SO ₂ converter. This line will display Converter sensor absent if the converter is not operating or not plugged in.
Lamp/Source	Pass if the lamp current is between 15-50mA.
Cooler	Status of the PMT cooler must be 13 °C $\pm 10\%$ to pass).
Ref Voltage	Pass if the reference voltage is within acceptable limits (1-4 V).
High Voltage	Fail if the high voltage value is <20 or >30 from the target. Target is 700 V (Standard).
System Power	Pass if the system has an adequate electrical supply.
Maintenance Mode	Error if the system is " In Maintenance " (refer to Section 3.4.12).

Diagnostic Mode	Error if the electronics are in Diagnostic Mode (refer to Section 3.4.13).
Diagnostic PTF Comp	Error if the Pres/Temp/Flow Comp. is disabled (refer to Section 3.4.13).
Diagnostic Control	Error if the control loop is disabled (refer to Section 3.4.13).
Valve Manual Control	Error if the valve sequencing is disabled (refer to Section 3.4.15).
SO2 Conc V Saturated	Indicates if the voltage of the concentration during measurement is within the limits of the analog to digital converter (-0.26 to 3.29V).
H2S Conc V Saturated	Indicates if the voltage of the concentration during measurement is within the limits of the analog to digital converter (-0.26 to 3.29V).
Bkgnd Conc V Saturated	Indicates if the voltage of the concentration during background measurement is within the limits of the analog to digital converter (-0.26 to 3.29V).
Flow Fault	Ok when the instrument has acceptable sample flow based on the difference between cell and ambient pressures.
Chassis Temp.	Pass if the chassis temperature is within the acceptable limits (0-50 °C).
Pressure Sensor	Pass if the cell pressure is within acceptable limits.
USB Stick Disconnected	Detects whether a USB memory stick is plugged into the front USB port.
Instrument Warmup	Ok once the instrument is out of warm-up status.

3.4.5 Temperature Menu

Main Menu → Analyser State Menu → Temperature Menu

Temperature Units	The current temperature units of the instrument (Celsius, Fahrenheit or Kelvin).
Set Point (CELL)	The temperature set point of the reaction cell. The factory default is 50 °C.
Set Point (CONVERTER)	The temperature set point of the converter. The factory default is 300 °C.
Converter	Temperature of the H ₂ S to SO ₂ converter. This line will display Converter sensor absent if the converter is not operating or not plugged in.
Cell	Displays current temperature of the reaction cell.
Chassis	Displays the temperature of air inside the chassis, measured on the main controller PCA board.
Cooler	Temperature of the PMT cold block.

3.4.6 Pressure & Flow Menu

Main Menu → Analyser State Menu → Pressure & Flow Menu

Pressure Units	Select the units that the pressure will be displayed in (torr, PSI, mBar, ATM or kPa).
Ambient	Current ambient pressure.
Cell	Current pressure within the reaction cell.
Sample Flow	Indicates the gas flow through the sample port of the instrument. The value should be ~0.7 slpm. If there is an error with the sample flow, it will read 0.00 slpm.

3.4.7 Voltage Menu

Main Menu → Analyser State Menu → Voltage Menu

High Voltage	The voltage applied to the PMT (normally set to 700 volts ±15 V for ambient applications).
Lamp Current	Displays the UV lamp current in mA.
Conc Voltage (RAW)	Voltage from the sensor proportional to the detected signal from the reaction cell. This voltage represents the actual measurement of gas.
Conc Voltage	Displays the detector voltage after PGA scaling.
Ref. Voltage	Displays the detector voltage after PGA scaling.
+5V Supply	+5 V power supply.
+12V Supply	+12 V power supply.
+ Analog Supply	+12 V (primary) power supply. The value should be within ±2 V.
- Analog Supply	-12 V (primary) power supply. The value should be within ±2 V.

3.4.8 General Settings Menu

Main Menu → General Settings Menu

Decimal Places	Select the number of decimal places (0-5) used for the concentration displayed on the home screen.
Conc. Units	Sets the concentration units (ppm, ppb, ppt, mg/m3, µg/m3 or ng/m3).
Conversion Factor [gravimetric units]	This option only appears if concentration units are set to gravimetric (mg/m3, µg/m3 or ng/m3). Select either 0 °C, 20 °C or 25 °C as the reference temperature to be used for the conversion of the measured volumetric values to mass values.
Temperature Units	Select the units that temperature will be displayed in (Celsius, Fahrenheit or Kelvin).

Pressure Units	Select the units that the pressure will be displayed in (torr, PSI, mBar, ATM or kPa).
Date	Displays the current date and allows users to edit if required.
Time	Displays the current time and allows users to edit if required.
Backlight	Select the length of time the screen and keypad backlight remain on after a button press. The setting Always Off means the backlight never turns on; the setting Always On means the backlight never turns off.
Home Screen	This field allows the user to display concentrations on the home screen in two formats. The first is Inst. only which displays only the instantaneous concentration reading, the second is Inst & Avg which displays both instantaneous and average concentration on the home screen. The average is measured over the time period set in Measurement Settings Menu (refer to Section 3.4.9).
Char 0 has Slash	When enabled, the instrument will display the zero character with a slash (0) to differentiate it from a capital 'O'.

3.4.9 Measurement Settings Menu

Main Menu → Measurement Settings Menu

Average Period	Set the time period over which the average will be calculated: Minutes (1, 3, 5, 10, 15 or 30) or hours (1, 4, 8, 12 or 24).
Filter Type	Sets the type of digital filter used (None, Kalman, 10 sec, 30 sec, 60 sec, 90 sec, 300 sec or Rolling). The Kalman filter is the factory default setting. The Kalman filter gives the best overall performance for this instrument.
Rolling Size [Rolling Filter]	Sets the number of measurements included in the rolling average. Only available if the Filter Type is set to Rolling .
Gas Measure Cycle	This is a user selectable menu that allows the user to set the duration of each cycle when Gas to Measure is set to Both . Duration can go from 5 to 240 minutes.
Bkgnd Interval	Sets the background interval time in hours (2, 4, 6, 8, 12, 24 or Disabled). The background will begin ten minutes before the end of the allocated period (e.g. at 12 hours a background occurs at 11:50 and 23:50). The results of the background are stored in the event log. The default setting is 24 hours.
Gas to Measure	This field allows the user to select whether the instrument will only measure SO2 , only measure H2S or measure Both SO ₂ and H ₂ S.
Off Gas is Invalid	When Enabled the cycle that is not sampling is considered invalid. The invalid reading will be displayed as #### .

Noise	<p>The standard deviation of the concentration. The calculation is as follows:</p> <ul style="list-style-type: none"> ▪ Take a concentration value once every two minutes. ▪ Store 25 of these samples in a first in, last out buffer. ▪ Every two minutes, calculate the standard deviation of the current 25 samples. <p>This reading is only valid if zero air or a steady concentration of span gas has been supplied to the instrument for at least one hour. An invalid reading will be displayed as #####.</p>
--------------	--

3.4.10 Calibration Menu

Main Menu → Calibration Menu

Calibrating the instrument should be done with care (refer to Section 5 before using these menus).

Cal. Type	<p>Depending on the selection in this field, a number of extra menu items will be displayed. These are separately documented in Manual Mode (refer to Section 3.4.10.1) and Timed Mode (refer to Section 3.4.10.2).</p> <p>Select the Cal. Type field and select either Timed or Manual. Timed mode is an automatic calibration controlled by the:</p> <ul style="list-style-type: none"> ▪ Interval between cycles ▪ Length of each calibration cycle ▪ Time when the calibration will begin ▪ Check only or automatic compensation <p>Manual mode allows the user to choose the type of calibration they wish to perform and will open the appropriate valves in preparation for the user to perform a manual calibration. The setup used will depend on the Cal. Mode selected.</p> <p>Manual mode is set as default.</p>
Zero Source	<p>Select whether the instrument will sample from the external calibration port or from the internal zero source when zero gas is requested.</p>
Cycle Time	<p>The duration of each Cal. Mode (span and zero) when performing Cycle Mode (refer to 3.4.10.1) or Cal. Type is set to Timed (refer to Section 3.4.10.2).</p>
Span Calibrate SO2	<p>This field is used to perform a span calibration and should be only used when a known concentration of span gas is running through the reaction cell and the reading is stable.</p> <p>Activating the span calibrate field for a named gas will open a dialog box. Enter the concentration of the span gas that the instrument is sampling and press Accept.</p>
Zero Calibrate SO2	<p>This command is used to correct the zero calibration setting. This option should be used only when zero gas is running through the reaction cell. Please refer to Section 5 before using this command.</p>

Zero Calibrate H2S	This command is used to correct the zero calibration setting. This option should be used only when zero gas is running through the reaction cell. Please refer to Section 5 before using this command.
Manual Background	Selecting start will immediately perform a background.
Pressure Calibration Menu	Refer to Section 3.4.11.
Pressure SO2	This field displays the reaction cell pressure measured during the last calibration.
Temperature	Reaction cell temperature when the last span calibration was performed.
Conv. Efficiency H2S	The efficiency of the conversion of H ₂ S to SO ₂ , in the H ₂ S converter.

3.4.10.1 Manual Mode

These items appear in the **Calibration Menu** when **Cal. Type** is set to **Manual**.

Cal. Mode	<p>When calibration type is set to Manual the instruments operational mode can be chosen from the following:</p> <ul style="list-style-type: none"> ▪ Measure (default): Is the normal measurement through the sample port. ▪ Zero: This mode will take air through the calibration port so that a zero calibration can be performed. Data is flagged as zero data. ▪ Span: This mode will take air through the calibration port so that a span calibration can be performed. Data is flagged as span data. ▪ Cycle: Performs a zero and a span Cal. Mode and then returns to measure mode. The length of time spent measuring each calibration mode is set in Cycle Time (refer to Section 3.4.10). <p>While the instrument is still in the warm-up period (refer to Section 3.1) the Cal. Mode cannot be changed from Measure mode.</p>
------------------	--

3.4.10.2 Timed Mode

These items appear in the **Calibration Menu** when **Cal. Type** is set to **Timed**.

Date	Enter the date for the next calibration to start.
Time	Enter the time that calibration will be performed. The time is set using a 24 hour clock.
Repeat	This field indicates the delay period; once the specified amount of time has lapsed the calibration will automatically run again. The user can edit this field (from 1 to 20,000 units).
Units	This is where the user can define the type of units for the Repeat delay period. For example: A repeat of “3” and units of “Days” means that a calibration will automatically be performed every three days.

Span Compensation	When Enabled the instrument will automatically perform a Span Calibrate SO2 at the end of the Cycle Time and adjust the gain based on the Span Level . When Disabled it will do a precision check only, no adjustment is made.
Span Level	Enter the concentration of span gas expected. Used when the Span Compensation is Enabled .

3.4.11 Pressure Calibration Menu

Main Menu → Calibration Menu → Pressure Calibration Menu

Entering this menu will set the valves to the pressure calibration configuration; leaving the menu will restore the valves to normal operation (Refer to Section 5.2).

Vacuum Set Pt.	The zero point for the calibration. Activating this item will open a dialog box of instructions.
Ambient Set Pt.	The high point for the calibration. Activating this item will open a dialog box of instructions.
Pressure Units	Select the units that the pressure will be displayed in (torr, PSI, mBar, ATM or kPa).
Ambient	The current ambient pressure.
	The current ambient pressure displayed as a raw voltage.
Cell	The current pressure in the reaction cell.
	The current reaction cell pressure displayed as a raw voltage.

3.4.12 Service Menu

Main Menu → Service Menu

Diagnostics Menu	Refer to Section 3.4.13.
Calculation Factors Menu	Refer to Section 3.4.19.
Load Auto-Backup Config.	Loads the auto-backup configuration file. The configuration is automatically backed up every night at midnight.
Load Configuration	Loads a user selectable configuration file from the USB memory stick.
Save Configuration	Saves all of the EEPROM-stored user-selectable instrument configurations to the USB memory stick (calibration and communication settings, units, instrument gain, etc.). If there are problems with the instrument use this function to save settings to the removable USB memory stick and send this file (together with the parameter list save) to your supplier with your service enquiry.

Save Parameter List	Saves a text file of various parameters and calculation factors. If you have problems with the instrument use this function to save settings to the removable USB memory stick and send this file (together with the configuration save) to your supplier with your service enquiry.
Instrument	This field allows the instrument to be set to either Online (normal instrument operation) or In Maintenance (data is flagged as invalid).
Next Service Due	Displays when the next scheduled service is due.
Safely Remove USB Stick	This command must be activated to safely remove the USB memory stick.
System Restart	Activating this will restart the instrument.

3.4.13 Diagnostics Menu

Main Menu → Service Menu → Diagnostics Menu

Digital Pots Menu	Refer to Section 3.4.14.
Valve Menu	Refer to Section 3.4.15.
Tests Menu	Refer to Section 3.4.16.
Pres/Temp/Flow Comp.	On (default): Is used to compensate instrument measurements for environmental fluctuations that might affect readings (pressure, temperature and flow). Off : Is used only when running diagnostics.
Control Loop	Enabled (default): Allows the instrument to automatically adjust digital pots and other outputs. Disabled : Prevents the instrument from changing most outputs so the service technician can manually control them.

3.4.14 Digital Pots Menu

Main Menu → Service Menu → Diagnostics Menu → Digital Pots Menu

Digital pots are electronically controlled digital potentiometers used for adjustments to operations of the instrument. Each of the digital pots can go from 0-255. This menu should be accessed only during diagnostics.

Unless the **Control Loop** is **Disabled** (refer to Section 3.4.13), changes to the pots may be modified by the instrument. This is intentional; some diagnostics are best done with instrument feedback and some are best done without.

High Volt Tuning	Disabled	When the instrument first starts it will tune the high voltage supply by automatically setting the High Volt Adj Pot . After a stable value is reached the instrument will Disable the High Volt Tuning . You can force the instrument to re-tune the high voltage supply by setting this field to Enabled and rebooting the instrument.
High Volt Adj Pot	145-165	Allows manual adjustment of the PMT high voltage supply.

High Voltage	690-715	The voltage applied to the PMT.
Lamp Adjust Pot	20-200	Adjusts the UV lamp current.
Lamp Current	34-36	Displays the UV lamp current in mA.
PGA Gain	1-128	Displays the gain of the PGA.
Input Pot	128	Reduces the raw signal to measurable level.
Meas. Zero Pot	25-220	Maintains the electronic zero adjustment.
Conc. Voltage (raw)	0-3.1	The concentration voltage measured by the analog to digital converter.
Conc. Voltage	0-3.1	The concentration voltage after adjustment for the PGA gain factor.
Ref. Zero Pot	128	Offset adjustment for the reference voltage.
Ref. Gain Pot	10-100	Adjusts the reference voltage. Occurs at start up and when the reference voltage is too far from the target voltage (2.5V).
Ref. Voltage	1.5-3.5	The reference voltage of the detector.
Diagnostic Mode	Operate	<ul style="list-style-type: none"> ▪ Operate (default): Puts the instrument in normal operation mode. ▪ Electrical: Injects an artificial test signal into the electronic processing circuitry on the main controller PCA to verify that the circuitry is operating correctly. When in this Diagnostic Mode, adjust the Diagnostic Test Pot from 0 to 255. This will produce a change in the concentration voltage as well as the indicated gas concentration. ▪ Preamp: Injects an artificial test signal into the Preamplifier module mounted in the optical bench to verify that the Preamplifier, cabling and electronic circuitry on the main controller PCA is operating correctly. When in this Diagnostic Mode, adjust the Diagnostic Test Pot from 0 to 255. This will produce a change in the concentration voltage as well as the indicated gas concentration. ▪ Optic [Optional]: Emits artificial light into the Reaction Cell to simulate a real fluorescence emission. This will verify that the PMT, Preamp and electronic circuitry on the main controller PCA is operating correctly. When in this Diagnostic Mode, adjust the Diagnostic Test Pot from 0 to 255. This will produce a change in the concentration voltage as well as the indicated gas concentration. This menu item is only available if you have installed the optical test lamp (refer to Section 3.4.30).
Diagnostic Test Pot	0	This Digital Pot is used for diagnostics only. When in the Electrical , Preamp or Optic Diagnostic Mode , this Digital Pot should be adjusted from 0 to 255. This will produce a change in the concentration voltage as well as the indicated gas concentration.

3.4.15 Valve Menu

Main Menu → Service Menu → Diagnostics Menu → Valve Menu

The **Valve Menu** allows the user to observe the instrument controlled switching of the valves. If the valve is On it means the valve is energised. When a three way valve is in the On state it will now be in the NC (normally closed) position as shown in the plumbing schematic. When the valve sequencing is

disabled the user has the ability to turn the valve Off and On manually. It is recommended that the valve menu be used by a trained technician following the plumbing schematic (refer to Section 9.5).

Note: When interpreting the information below regarding the flow path through the valve note that (NC = Normally Closed), (NO = Normally Open) and (C = Common).

Valve Sequencing	<p>When Enabled the valves will turn On and Off under the instruments control (even if you have manually turned Off or On a valve).</p> <p>When Disabled the valves will change only in response to a user's action.</p>
Sample/Cal	<p>Indicates if the Sample/Cal valve on the Calibration Valve Manifold is Off or On. This will determine the port the instrument draws its sample from.</p> <p>Off = Flow from NO to C (drawing sample from the Sample Port).</p> <p>On = Flow from NC to C (drawing sample from the Calibration Port).</p>
Internal Zero/Cal	<p>Indicates if the Internal Zero/Cal valve on the Calibration Valve Manifold is Off or On. This will determine the port the instrument draws its sample from, when selecting Cal. Mode → Zero.</p> <p>Off = Flow from NO to C (drawing sample from the BGnd Air Port).</p> <p>On = Flow from NC to C (drawing sample from the Calibration Port).</p>
H2S Bypass Flow	<p>Indicates if the H2S Bypass Flow valve on the Aux Valve Manifold is Off or On. This will determine if the instrument is bypassing the H₂S or not. The H₂S path flows continuously to ensure stable converter temperatures.</p> <p>Off = Flow from NO to C (H₂S path directed out exhaust)</p> <p>On = No flow (bypass is blocked).</p>
H2S/SO2	<p>Indicates if the H2S/SO2 valve on the Aux Valve Manifold is Off or On. This will determine the path the instrument draws its sample from H₂S path or SO₂ path.</p> <p>Off = Flow from NO to C (drawing sample from the H₂S path).</p> <p>On = Flow from NC to C (drawing sample from the SO₂ path).</p>
Pressurised Zero [Optional]	<p>Indicates if the optional pressurised zero port valve is Off or On (refer to Section 8.3).</p>
Pressurised Span [Optional]	<p>Indicates if the optional pressurised span port valve is Off or On (refer to Section 8.3).</p>

3.4.16 Tests Menu

Main Menu → Service Menu → Diagnostics Menu → Tests Menu

Screen Test	Performs a screen test by drawing lines and images on the screen so that the operator can determine if there are any faults in the screen. Press a keypad key to step through the test. The up and down arrow keys will adjust the contrast.
-------------	---

Digital Input Test Menu	Refer to Section 3.4.17.
-------------------------	--------------------------

Digital Output Test Menu	Refer to Section 3.4.18.
--------------------------	--------------------------

3.4.17 Digital Input Test Menu

Main Menu → Service Menu → Diagnostics Menu → Tests Menu → Digital Input Test Menu

Input 0..7	Displays the status of the 0-7 digital input pins. Value will be 0 or 1.
------------	--

Note: Entering either the Digital Inputs Menu will temporarily disable all digital and analog input/outputs. This will affect logging via these outputs. Exiting the menu restores automatic control.

3.4.18 Digital Output Test Menu

Main Menu → Service Menu → Diagnostics Menu → Tests Menu → Digital Output Test Menu

Automated Test	When started will automatically step through each output, turning it On and Off.
----------------	--

Output 0..7	Displays the state of the output pin (On or Off) and allows the user to manually set the state.
-------------	---

Note: Entering either the Digital Outputs Menu will temporarily disable all digital and analog input/outputs. This will affect logging via these outputs. Exiting the menu restores automatic control.

3.4.19 Calculation Factors Menu

Main Menu → Service Menu → Calculation Factors Menu

The **calculation** factors provide the values used to calculate different aspects of measurement and calibration.

Dilution Ratio	Entering a value here will multiply the displayed and recorded measurements by the dilution amount. For example, if the instrument is measuring a source where the average concentration is above the upper limit of the measurement range, a dilution probe with a fixed ratio dilution ratio can be used to reduce the level measured by the instrument, so for a 4:1 dilution ratio, enter a value of 4. Enter the ratio here so the analyser can display the correct value on the instrument. The default value is 1.00 (this indicates no dilution is applied).
----------------	--

Instrument Gain	A multiplication factor used to adjust the concentration measurement to the appropriate level (set at calibration).
Zero Offset SO2	This field displays the offset created from a zero calibration. This is the concentration measured from zero air and is subtracted from all readings.
Zero Offset H2S	This field displays the offset created from a zero calibration. This is the concentration measured from zero air and is subtracted from all readings.
Background	The correction factor calculated from the background cycle (used to eliminate background interferences).
PTF Correction SO2	Displays the correction factor applied to the concentration measurement. This correction is for changes in pressure, temperature and flows since the last calibration.
PTF Correction H2S	Displays the correction factor applied to the concentration measurement. This correction is for changes in pressure, temperature and flows since the last calibration.
Conv. Efficiency H2S	The efficiency of the conversion of H ₂ S to SO ₂ , in the H ₂ S converter.
Noise	<p>The standard deviation of the concentration. The calculation is as follows:</p> <ul style="list-style-type: none">▪ Take a concentration value once every two minutes.▪ Store 25 of these samples in a first in, last out buffer.▪ Every two minutes, calculate the standard deviation of the current 25 samples. This is a microprocessor-generated field and cannot be set by the user. <p>This reading is only valid if zero air or a steady concentration of span gas has been supplied to the instrument for at least one hour.</p>

3.4.20 Communications Menu

Main Menu → Communications Menu

Configures how the instrument communicates with external instrumentation and data loggers.

Data Logging Menu	Refer to Section 3.4.21.
Serial Communication	Refer to Section 3.4.22.
Analog Input Menu	Refer to Section 3.4.23.
Analog Output Menu	Refer to Section 3.4.24.
Digital Input Menu	Refer to Section 3.4.26.
Digital Output Menu	Refer to Section 3.4.26.
Network Menu	Refer to Section 3.4.27.
Bluetooth Menu	Refer to Section 3.4.28.

3.4.21 Data Logging Menu

Main Menu → Communications Menu → Data Logging Menu

When editing the numeric or text menus, the “-” key will delete the current parameter and move the others up to take its place; the “+” key will insert a parameter at the current location and move the ones below it down. The internal logger can log a maximum of 12 parameters.

Data Log Interval	Displays the interval at which the data is saved to the USB memory stick. Selecting a 1 sec interval may result in occasional measurements not being logged or slow response to serial commands.
Data Log Setup – Numeric	Numeric list of the parameters logged. This is a quicker way to enter parameters if you have the list of parameter numbers handy.
Data Log Setup – Text	Select the list of logged parameters by name.

3.4.22 Serial Communication Menu

Main Menu → Communications Menu → Serial Communication Menu

Serial ID	This is the ID of the instrument when using multidrop RS232 communications. This ID can be changed to support multiple instruments on the same RS232 cable.
Service port (RS232 #1) Multidrop port (RS232 #2)	The port parameters below are repeated for each serial port.
Serial Delay	Some older communication systems require a delay before the instrument responds to a serial command. The number of milliseconds of delay required (0-1000). The default is 0, meaning the instrument responds as quickly as possible to any serial request.
Baudrate	Sets the baud rate for this serial port (1200, 2400, 4800, 9600, 14400, 19200, 38400 or 115200).
Protocol	Sets the protocol used for this serial port (Advanced, ModBus, EC9800 or Bayern-Hessen). This must be set to Advanced for Ecotech supplied software.
Endian [Modbus Protocol]	Select Little or Big endian mode for ModBus protocol.

3.4.23 Analog Input Menu

Main Menu → Communications Menu → Analog Input Menu

The Serinus supports three analog inputs from the 25 pin I/O connector. Each input is a 0 to 5 volt CAT 1 input that can be scaled and logged to the USB memory stick or accessed remotely as parameters 199 to 201.



CAUTION

Exceeding these voltages can permanently damage the instrument and void the warranty.

Input 1/2/3	The sections below are repeated for each analog input.
Multiplier	The input voltage will be multiplied by this number. For example, if a sensor has a 0-5V output for a temperature of -40 °C to 60 °C, the multiplier would be $(60 - (-40)) / 5 = 20$.
Offset	This value will be added to the above calculation. Continuing the example in the multiplier description, the offset should be set to -40, so that a voltage of 0V will be recorded as -40 °C.
Reading	The current reading from the input voltage, after the multiplier and offset has been applied. This is the value that is logged or reported as parameter 199 to 201 via USB or serial requests.

3.4.24 Analog Output Menu

Main Menu → Communications Menu → Analog Output Menu

Output Mode	The analog output can be set to be either Current or Voltage . Different fields will be displayed depending on which analog output type is selected.
SO2	The name of the gas for the analog output.
Min Range	Set the lower range limit (in concentration units). This is the value at which the analog output should be at its minimum. For example, 4mA for a 4 to 20mA current output.
Max Range	Set the upper range limit (in concentration units). This value can be edited but cannot exceed the Over-Range value. This is the value at which the analog output should be at its maximum. For example, 20mA for a current output.
Over-Ranging	Set to Enabled or Disabled to turn the over-ranging feature on or off.
Over-Range	This field is only visible when Over-Ranging is set to Enabled . Set to the desired over range value. This value cannot be set below the Max Range value. This is the alternate scale the used for the analog output when over-ranging is active and enabled. When 90 % of the standard range is reached, this over range is automatically entered. When 80 % of the original range is reached, it returns to the original range.

3.4.24.1 Analog Output Menu - Voltage

Main Menu → Communications Menu → Analog Output Menu

These items appear when **Output Mode** is set to **Voltage**.

Voltage Offset	Choices are 0V , 0.25V or 0.5V . This sets the voltage for a reading of 0. Since the output cannot go negative, this offset can be used to record negative readings.
0.5V Calibration	Enables the user to calibrate the analog voltage output at a low point. Increase/decrease the value until the connected equipment reads 0.5 V (refer to Section 4.4.1.1).
5.0V Calibration	Enables the user to calibrate the voltage output at a full scale point (5 V). Increase/decrease the value until the connected equipment reads 5 V (refer to Section 4.4.1.1).

3.4.24.2 Analog Output Menu - Current

Main Menu → Communications Menu → Analog Output Menu

These items appear when **Output Mode** is set to **Current**.

Current Range	Enables the user to set desired current ranges. Choices are 0-20mA , 2-20mA or 4-20mA .
4mA Calibration	Enables the user to calibrate the current output at a low point. Increase/decrease the value until the connected equipment reads 4mA (refer to Section 4.4.1.2).
20mA Calibration	Enables the user to calibrate the current output at a full scale point (20mA). Increase/decrease the value until the connected equipment reads 20mA (refer to Section 4.4.1.2).

3.4.25 Digital Input Menu

Main Menu → Communications Menu → Digital Input Menu

This menu is used to remotely trigger zero and span calibrations. This is done by assigning the eight digital inputs with one of the following commands.

DI N (Pin X)	<p>Associates an action with a digital input. There are eight digital inputs (the pin numbers are for the 25 pin connector). Each one can have one of the following associated actions, triggered when the corresponding digital input goes to the Active state:</p> <ul style="list-style-type: none"> ▪ Disabled: No action (this digital input does nothing). ▪ Do Span: Used to perform a span precision check. When activated the instrument sets the Cal. Mode to Span (refer to Section 3.4.10.1). ▪ Do Zero: Used to perform a zero precision check. When activated the instrument sets the Cal. Mode to Zero (refer to Section 3.4.10.1).
---------------------	---

Active	Each pin can be set to be active High or Low . Active High means that the event will be triggered when the line is pulled to 5V. Active Low means that the event will be triggered when the line is pulled to 0V.
---------------	---

Example

Here is a typical configuration between an instrument and either a data logger or calibrator (master device):

1. Set the jumper JP1 to 5V position (refer to Section 4.4.3).
2. Connect one of the master devices digital output signals to pin 18 and the ground signal to pin 5 of the instrument’s analog/digital 25 pin female connector (refer to Figure 20).
3. Program master device to output 0 volts to pin 18 when a span is desired.
4. In the instrument’s **Digital Input Menu** assign **DI 0 Do Span**.
5. The same procedure can be followed to also activate zero calibrations. Pin 6 of the instrument’s analog/digital 25 pin female connector can be connected to one of the other master devices digital outputs and the instrument can be set so **DI 1** is assigned to **Do Zero**.

3.4.26 Digital Output Menu

Main Menu → Communications Menu → Digital Output Menu

This allows the instrument to trigger external alarms in response to certain events.

There are eight different pins available, which will be set high during an associated event:

DO N (Pin X)	Associates a state with a digital output. There are eight digital outputs (the pin numbers are for the 25-pin connector). Each one can have one of the associated states listed in Table 3. The pin will be driven to the active state while the instrument state is true.
Active	Each pin can be set to be active High or Low . Active High means that the pin will be pulled to 5 V when the associated event occurs. Active Low means the pin will be pulled to 0 V when the associated event occurs.

Table 3 – Digital Output States

Digital Output State	Description
Disabled	No state (this output is never set high).
High Volt. Fail	High voltage fault.
Pwr Supply Fail	Power supply fault.
Ref Volt. Fail	Reference voltage fault.
A2D Fail	Analog to digital fault.

Digital Output State	Description
Lamp Fail	Lamp fault.
Flow Fail	Sample flow fault.
Cell Heat Fail	Cell heater fault.
Flow Heat Fail	Flow block heater fault.
Lamp Heat Fail	Lamp heater fault.
Chassis Tmp Fail	Chassis temperature fault.
Cooler Fail	Cooler temperature fault.
USB Disconnected	The USB memory stick is disconnected.
Background	Performing a background.
Span	Performing a span check.
Zero	Performing a zero check.
System Fault	Any system fault (the red light is on).

3.4.27 Network Menu

Main Menu → Communications Menu → Network Menu

The **Network Menu** only appears when the **Network Port** is enabled in the **Hardware Menu** (refer to Section 3.4.30). The **Network Menu** allows the user to view or set the IP Address, Netmask and Gateway if the optional network port is installed.

Start-up Mode	<p>The following modes are available:</p> <ul style="list-style-type: none"> ▪ NORMAL: In this mode nothing is done with the network port during boot-up. It is assumed to be configured correctly or unused. ▪ READ IP: This mode interrogates the network port for its IP address. The menu will display the network address after boot-up. ▪ SET IP: The user may enter an IP address, Netmask and Gateway address (following the usual rules for formatting these addresses). At this time the instrument does not validate the correctness of these entries. When you cycle power, the instrument will first instruct the network port on its new address. It will switch to Read IP mode and read back the address it just set so the user may verify it in the menu. ▪ Set DHCP: This sets the network port into DHCP mode, allowing the network to assign the instrument an IP address.
IP Address [Read or Set mode]	This is the current IP address of the instrument.
Netmask [Read or Set mode]	This is the subnet mask of the network the instrument is connected to.

Gateway [Read or Set mode]	This is the IP address of the router to access addresses not on the same subnet.
Adaptor is in DHCP mode [DHCP mode]	In this mode the instrument will ask for its network parameters from a DHCP server on your network.
Protocol	Sets the protocol used for the network port (Advanced, ModBus, EC9800 or Bayern-Hessen). This must be set to Advanced for Ecotech supplied software.
Endian [Protocol Modbus]	Select Little or Big endian mode for ModBus protocol.

To read the IP address, perform the following steps:

1. Set the instrument to Read IP
2. Manually cycle power off
3. Wait three seconds
4. Turn power on
5. Read or set the IP address.

3.4.28 Bluetooth Menu

Main Menu → Communications Menu → Bluetooth Menu

This instrument supports Bluetooth communication through the Serinus Remote Android Application (refer to Section 4.6).

Bluetooth	This field indicates whether the analyser is remotely connected to an Android device.
Reset	After changing the ID or PIN, it is necessary to reboot the Bluetooth module. This is done by resetting the analyser or by using this menu item to reboot only the Bluetooth.
ID	This is the Bluetooth ID of the instrument. Use the keypad to edit this field (refer to Section 3.3.1). The default ID setting is SerinusXXXXX (Ecotech ID) . The word Serinus is always the first part of the name and cannot be edited. The second part is the Ecotech ID .
PIN	This is a passcode/pin required for the Serinus Remote Application to connect to the instrument. The default pin is 1234.

3.4.29 Advanced Menu

This menu is accessed via a different method than the other menus. From the **Home Screen** press the following keys:

(-)99(+)
 (SPACE)

This menu contains technical settings, diagnostics and factory hardware installations. No items in this menu should be accessed without authorisation and supervision of qualified service personnel.

Language	Select a language.
Hardware Menu	Refer to Section 3.4.30.
Service Displays	When set to On , new items appear on many different menus. These fields are for diagnostic and service personnel only. Default is Off .
Next Service Due	Enables the user to edit the next service due date.
Jump to Next State	Moves the sequence to the next state (e.g. from Fill to Measure). This command is most commonly used to force an instrument out of the warm-up sequence early.
Parameter Display Menu	Refer to Section 3.4.31.
Reset to Factory Defaults	Reset the configuration to factory defaults. This will erase all calibrations and user configuration information.
Rebuild Index	If a data log becomes corrupted it may be possible to restore it by rebuilding its index file. This command will ask you to specify a month and will rebuild the index for that month. This operation can take many minutes and it should not be interrupted. While the file is rebuilding any data logging will be suspended.

3.4.30 Hardware Menu

Advanced Menu → Hardware Menu

This menu contains factory hardware installations. If you reset to factory defaults you may need to revisit this menu to enable your installed optional features.

Variant	Select the instrument model. Normally this only needs to be reset when the configuration is corrupted. The selections available will depend on licensing. It is not recommended to run an instrument with firmware set to an incorrect model.
Range	Select the range of the instrument. Not all instruments support all ranges. Default is Standard .
Front Panel Style	Choosing the incorrect front panel will result in the traffic lights behaving inconsistently. Default is Aluminium .
Network Port	When Enabled indicates the instrument has a network port installed. Default is Disabled .
Orifice Size	Specify the input orifice. Default is 0.75 .
Optical Test Lamp	Allows optical diagnostic tests. Default is Disabled .
SO2 Lamp Target	Allows the user to adjust the Lamp current target. The default is 35mA



CAUTION

No items in this menu should be accessed without authorization and supervision of qualified service personnel.

3.4.31 Parameter Display Menu

Advanced Menu → Parameter Display Menu

Used to display a logged parameter on the screen (refer to Table 19 for a list of parameters).

Data Parameter	Enter the Advanced Command parameter number.
Name	Displays the name of the selected parameter.
Value	Displays the current value of the selected parameter.

4. Communications

The Serinus has a number of different interfaces for communication with other equipment (RS232, USB, 25 pin digital/analog input/output, TCP/IP network (optional) and Bluetooth). A demonstration version of Ecotech's Airodis software is included with the instrument, enabling basic data downloads and remote operation from a PC running MS Windows (7 or 8). The full version of Airodis is available separately and includes automated data collection, data validation and complex reporting by multiple users. Refer to the Airodis Manual and Section 4.6 for details on setting up and communicating with the Serinus.

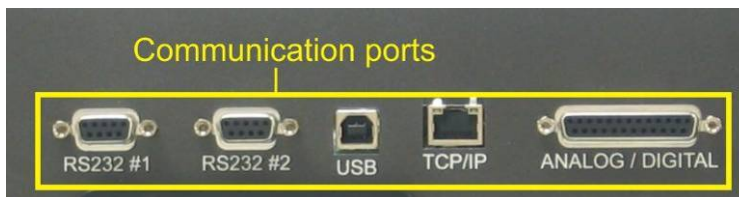

Figure 12 – Communication Ports

4.1 RS232 Communication

RS232 communication is a very reliable way to access data from the instrument and is recommended for use in connection to a data logger for 24/7 communication. Both RS232 ports are configured as DCE and can be connected to DTE (Data Terminal Equipment such as a data logger or computer).

Port #2 also supports a multidrop arrangement (a configuration of multiple instruments connected via the same RS232 cable where the transmit signal is only asserted by the instrument that is spoken to).

For reliable Multidrop RS232 communications please follow these guidelines:

- Verify that the Serial ID is set to a unique value which is different to the other instruments in the chain (refer to Section 3.4.22).
- All of the instruments in the multidrop chain must have the same baud rate and communication protocol settings. A maximum of 9600 baud rate is recommended.
- The Multidrop RS232 cable should be kept to less than three meters in length.
- A 12K ohm terminating resistor should be placed on the last connector of the cable (connect from pin 2 to pin 5 and from pin 3 to pin 5 – refer to Figure 13).
- The shielding of the Multidrop cable must be continuous throughout the cable.
- The shielding of the Multidrop cable must only be terminated at one end. It should be connected to the metal shell of the DB 9 way connector.

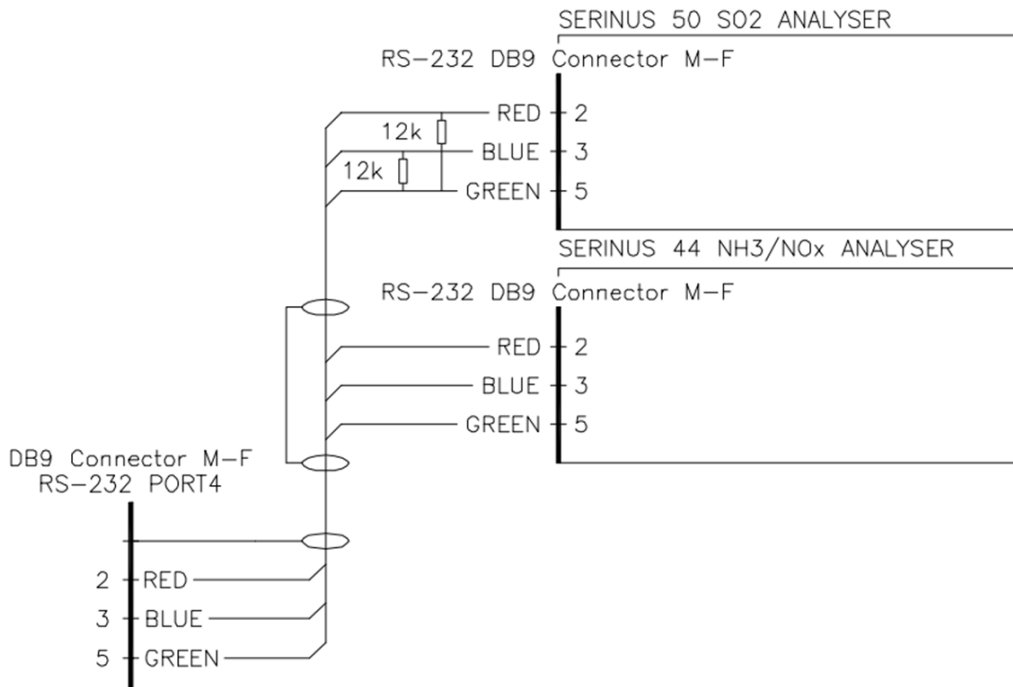

Figure 13 – Multidrop RS232 Cable Example

4.2 USB Communication

This is ideal for irregular connection to a laptop running Ecotech’s Airodis software to download logged data and remotely control the instrument. Due to the nature of USB, this is a less reliable permanent connection as external electrical noise can cause USB disconnection errors on a data logger.

For more information on making connections refer to Section 4.6.1.1.

Note: Only the Advanced protocol is supported for USB communication.

4.3 TCP/IP Network Communication (optional)

Instruments with the optional network port installed can be accessed using a TCP/IP connection. Figure 15 shows examples of some possible configurations for remote access.

Direct Connection

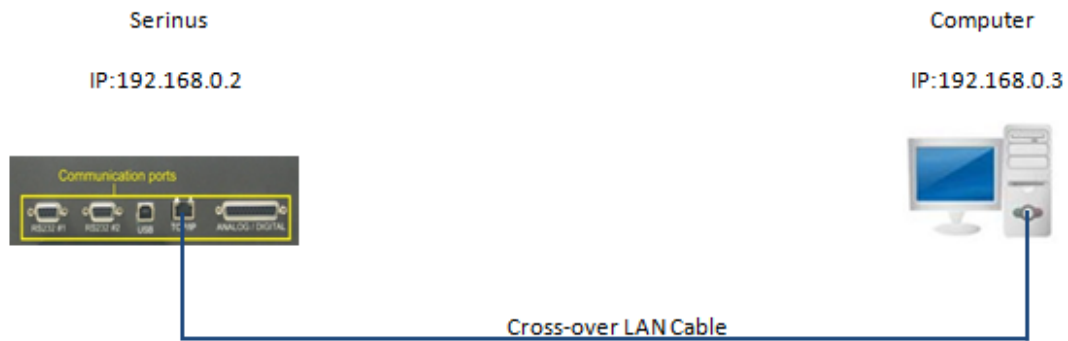

LAN

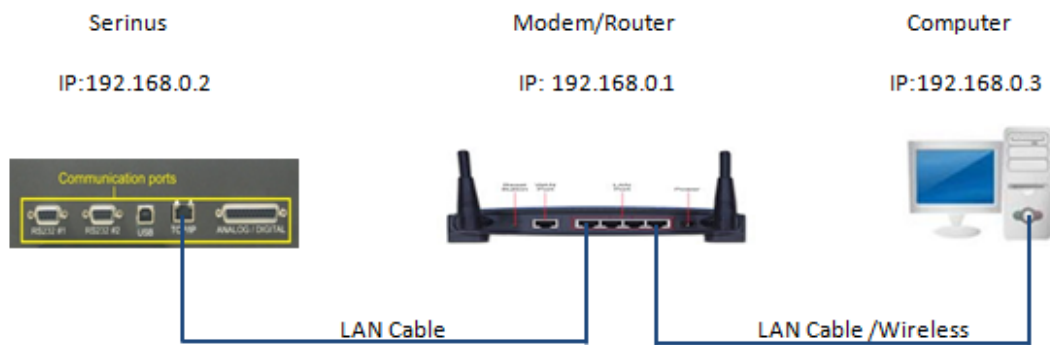

WAN

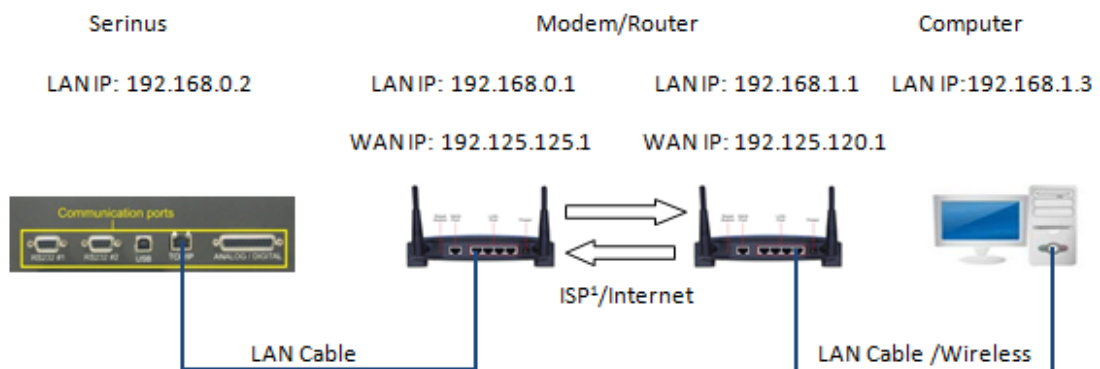

¹ ISP: Internet Service Provider

Figure 14 – Example of Typical Network Setups

Note: In Figure 15 all the IP addresses are taken as an example. The WAN IP addresses are normally provided by your ISP. Whereas, the LAN IP addresses can be set manually to any range which is within the subnet of the Modem/Router/switch.

Use a cross-over LAN cable to connect the instrument directly to a computer, or a standard LAN cable for connection to a Modem/Router/Switch as shown in Figure 15. The computer could be connected to the Modem/Router using either CAT5 cable or a wireless connection, but the instrument must be connected using CAT5/6 cable.

4.3.1 Network Setup

Below is an example of how to setup the network.

1. Open - **Main Menu** → **Communications Menu** → **Network Menu**.
2. Select - **Protocol** → **Advanced** - Accept.
3. Select - **Start-up Mode** → **Set IP** - Accept.
4. Edit - **IP Address** - (Change the IP address to the address you wish to use within the Modem/Router/switch subnet).
5. Edit - **Netmask** - (Change the Netmask to the setup specified by the Modem/Router).
6. Edit - **Gateway** - (Change the Gateway to the setup specified by the Modem/Router).

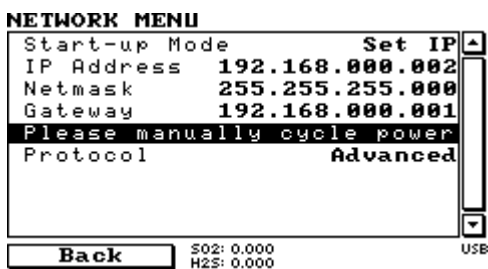

Figure 15 – Example of Network Menu Setup

7. Once completed, use the power switch on the rear of the instrument to turn the power Off. Please leave the instrument off for 10 seconds before turning the power back On.

Note: Manually perform a hardware power cycle every time the IP address is changed for it to take affect.

4.3.2 Port Forwarding on Remote Modem/Router Setup

When using the network port to connect to the router / modem with NAT enabled, you will need to add IP mapping to ensure that data is forwarded through to the desired port. This is known as port forwarding. To set-up the port for the instrument, you will need to go into the modem/router configuration. Normally, you will see the port forwarding setup under Port Forwarding, NAT or Port Mapping menu. Below is an example port forwarding setup.

The default port for the Serinus range of instruments is 32783. The destination address is the instrument IP address setup in the **Network Menu**.

Item	Protocol	Incoming Address	Incoming Port	Destination Address	Destination Port
1	tcp	0.0.0.0	32783 - 32783	192.168.0.2	32783 - 32783

Figure 16 – Port Forwarding Example

4.3.3 Airodis Setup to Communicate with Serinus

Below is an example of Airodis setup for a LAN network. Ensure the IP address is set to the same as on the instrument **Network Menu**.

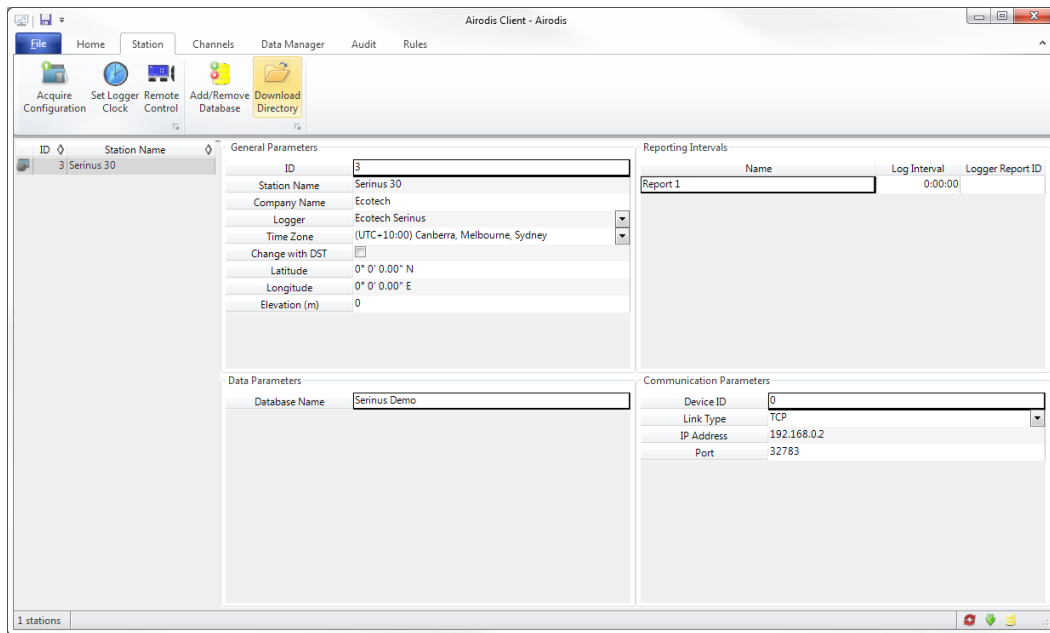

Figure 17 – LAN Network Set-Up (Airodis)

Below is an example of Airodis setup for a WAN network. Ensure the IP address is set the same as on the remote modem/router.

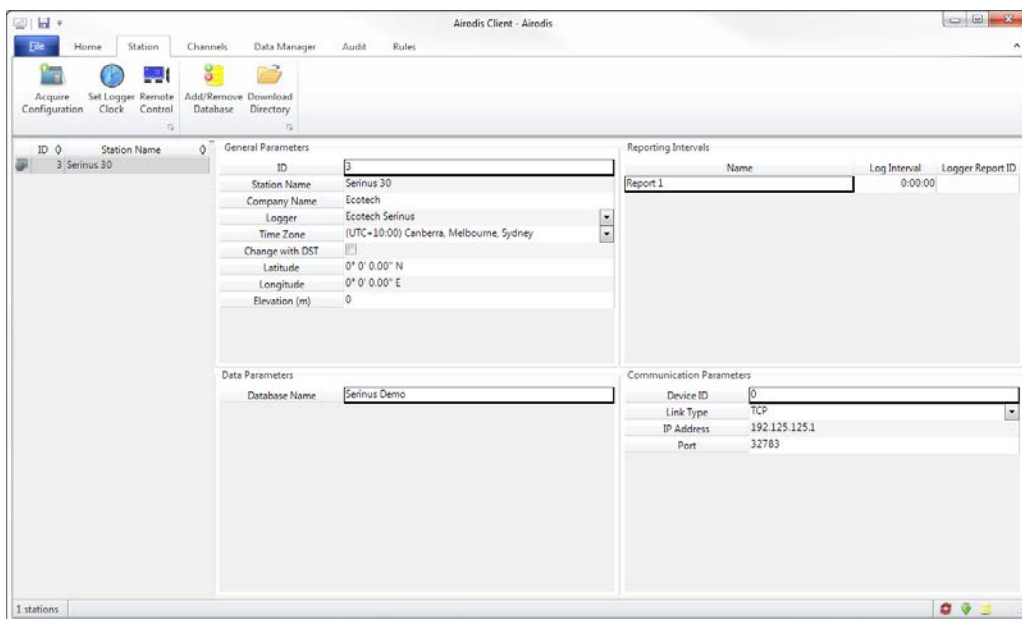

Figure 18 – WAN Network Set-Up (Airodis)

4.4 Digital/Analog Communication

The 25 Pin analog/digital port on the rear of the instrument sends and receives analog/digital signals to other devices. These signals are commonly used to activate gas calibrators or for warning alarms.

4.4.1 Analog Outputs

The instrument is equipped with one to three analog outputs that can be set to provide either voltage (0-5 V, 0.25-5 V, 0.5-5V, 0-10 V) or current (0-20, 2-20, 4-20 mA). The analog outputs are tied to specific instrument measurements, depending on the instrument type.

For 0-10V analog output operation, set the output type to current and move the jumpers (JP3) on the rear panel PCA to 0-10 V (refer to Figure 19).

Table 4 – Analog Outputs

Analyser	Output 1	Output 2	Output 3
Serinus 10	O ₃	N/A	N/A
Serinus 30	CO	CO ₂ [Optional]	N/A
Serinus 40	NO	NO _x	NO ₂
Serinus 44	NO	NH ₃	NO ₂
Serinus 50	SO ₂	N/A	N/A
Serinus 51	SO ₂	H ₂ S	N/A
Serinus 55	H ₂ S	N/A	N/A

Analyser	Output 1	Output 2	Output 3
Serinus 56	TS	N/A	N/A
Serinus 57	TRS	N/A	N/A
Serinus Cal 3000	N/A	O ₃	N/A

4.4.1.1 Analog Outputs Voltage Calibration

Equipment Required

- Multimeter (set to volts)
- Male 25 pin connector with cable

Procedure

1. Open - **Main Menu** → **Communications Menu** → **Analog Output Menu** (refer to Section 3.4.24).
2. Select - **Output Mode** → **Voltage**.
3. Connect a multimeter (using an appropriate adaptor or probes on the multimeter) to the ground (pin 24) and the relevant output pin (pin 10).
4. Edit - **0.5V Calibration** - (until the multimeter reads 0.500 ± 0.002) - Accept.
5. Edit - **5.0V Calibration** - (until the multimeter reads 5.00 ± 0.002) - Accept.

4.4.1.2 Analog Outputs Current Calibration

Equipment Required

- Multimeter (set to mA)
- Male 25 pin connector with cable

Procedure

1. Open - **Main Menu** → **Communications Menu** → **Analog Output Menu** (refer to Section 3.4.24).
2. Select - **Output Mode** → **Current**.
3. Connect a multimeter (using an appropriate adaptor or probes on the multimeter) to the ground (pin 24) and the relevant output pin (pin 10).
4. Edit - **4mA Calibration** - (until the multimeter reads $4\text{mA} \pm 0.01$) - Accept.
5. Edit - **20mA Calibration** - (until the multimeter reads $20\text{mA} \pm 0.01$) - Accept.

4.4.2 Analog Inputs

The instrument is also equipped with three analog inputs with resolution of 15 bits plus polarity, accepting a voltage between 0-5V. These go directly to the microprocessor and should be protected to ensure static/high voltage does damage the main controller PCA (instrument warranty does not cover damage from external inputs).

4.4.3 Digital Status Inputs

The instrument is equipped with eight logic level inputs for the external control of the instrument such as Zero or Span sequences. Each input has a terminating resistor which can be either PULL UP or PULL DOWN. This is set using the jumper JP1 on the back panel PCA (refer to Figure 19).

4.4.4 Digital Status Outputs

The instrument is equipped with eight open collector outputs which will convey instrument status condition warning alarms such as no flow, sample mode, etc. Two of the digital outputs can be set so that there is +5 V and +12 V available on the 25 pin connector for control purposes, instead of digital outputs 0 and 1.

In the default jumper locations (refer to Figure 19) these two outputs will function normally as open collector outputs. If moved to the position closer to the 25 pin connector then the DO 0 will supply +12 V and DO 1 will supply +5 V.

The +12 V and +5 V supplies are limited to about 100 mA each.

Each digital output is limited to a maximum of 400 mA. The total combined currents should not exceed 2 A.

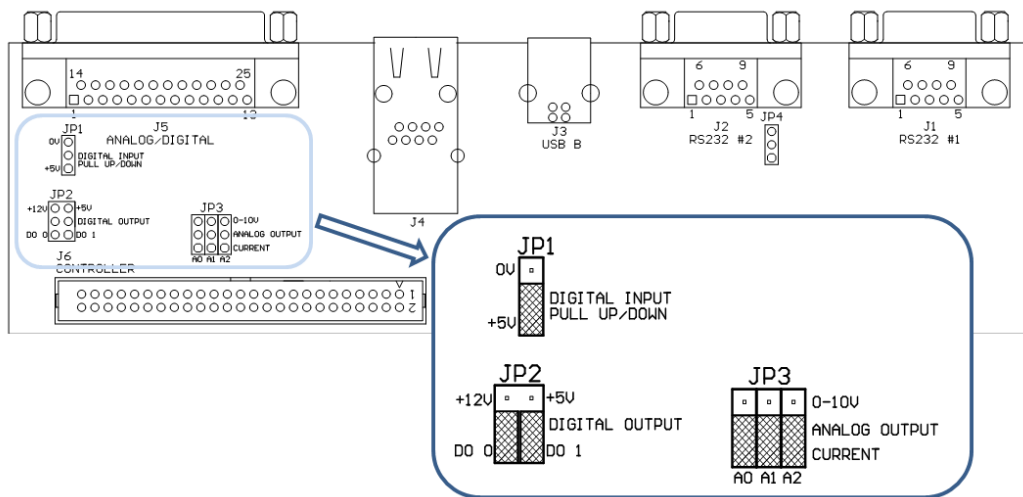

Figure 19 – 25 Pin Rear Panel PCA (Default Jumpers Highlighted)

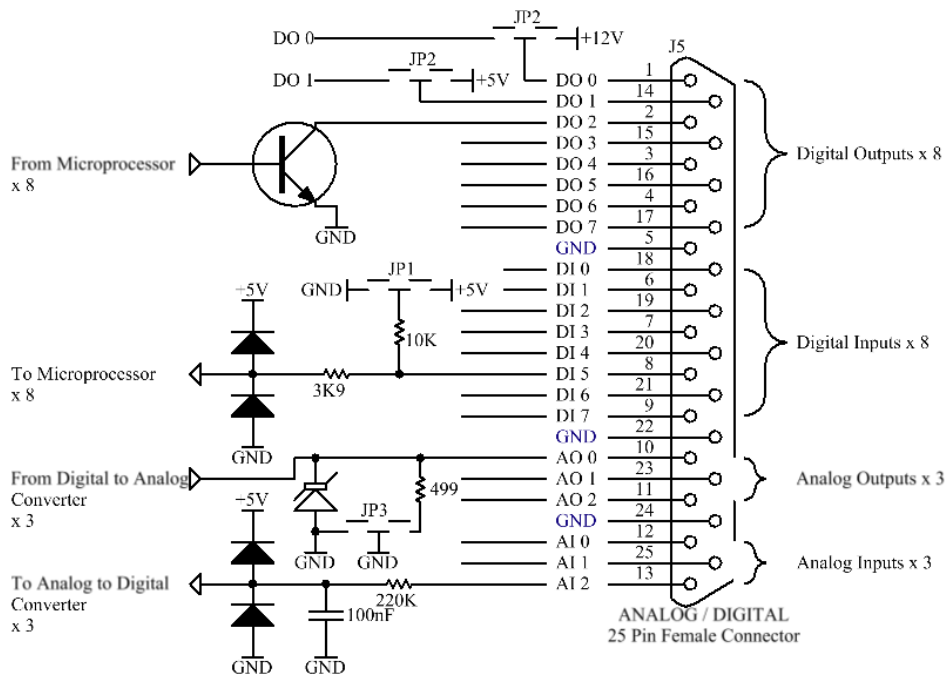

Figure 20 – External 25 Pin I/O Individual Pin Descriptions



CAUTION

The analog and digital inputs and outputs are rated to CAT I. Exceeding 12 VDC or drawing greater than 400 mA on a single output or a total greater than 2 A across the eight outputs can permanently damage the instrument and void the warranty.

4.5 Logging Data

When the user receives the instrument from the factory it will have a default set of parameters already setup in the internal data logger. These select few parameters have been chosen for their relevance in assisting in troubleshooting the instrument.

4.5.1 Configure Instrument Internal Logging

In order to log data you must first specify a data logging interval. This is how often data will be logged to the USB memory stick. You can log a maximum of 12 parameters. These parameters can be selected by name or by parameter number (refer to Table 19).

Procedure

1. Open - **Main Menu** → **Communications Menu** → **Data Logging Menu** (refer to Section 3.4.21).
2. Select - **Data Log Interval** - (adjust to the desired value) - Accept.

4.6 Using Airodis Software to Download Data

4.6.1 Connecting the Instrument to Your PC

This instrument can communicate with a PC using RS-232 (Serial), TCP/IP (Network), Bluetooth or USB. Serial, Bluetooth and network communications do not require additional drivers. If you wish to connect using a USB cable, the driver must be installed.

4.6.1.1 Connecting Over USB

If you wish to connect using USB, you will need to first install the Serinus USB driver.

Power on the instrument and connect it to your PC with a USB cable. You should receive a prompt if the driver needs to be installed. If not, open Device Manager (Under “System” in Control Panel), find the device and select “Update Driver Software”.

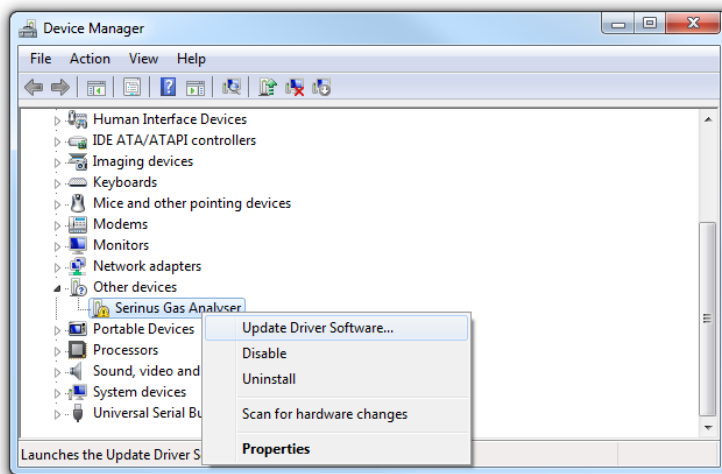

Figure 21 – Installing Driver Software (Device Manager)

When prompted where to search for the driver, select “**Browse my computer for driver software**”.

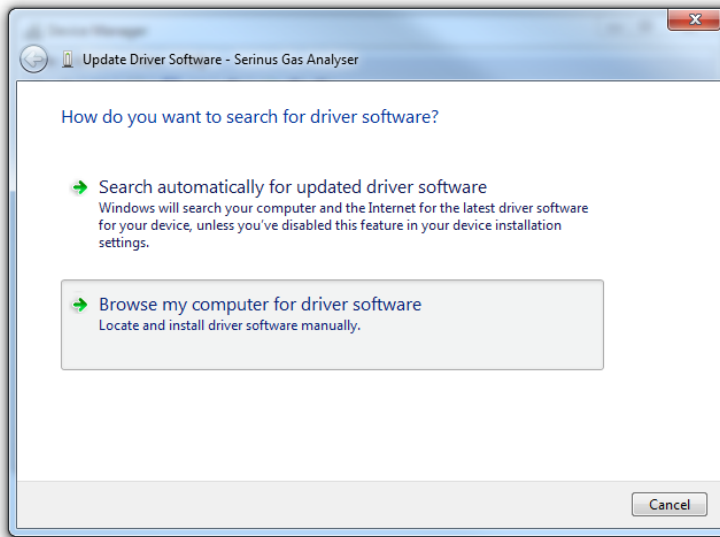

Figure 22 – Update Driver Popup

The Serinus USB driver is located on the green Ecotech resources USB stick under “\Drivers\Ecotech Analyser”. Select this directory and click **Next**.

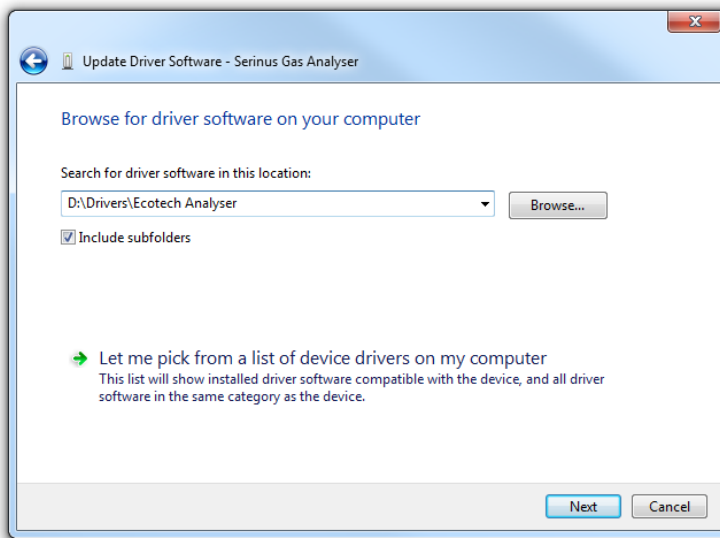

Figure 23 – Update Driver Popup (Directory Location)

If you receive a confirmation prompt to install the driver, select **Install**.

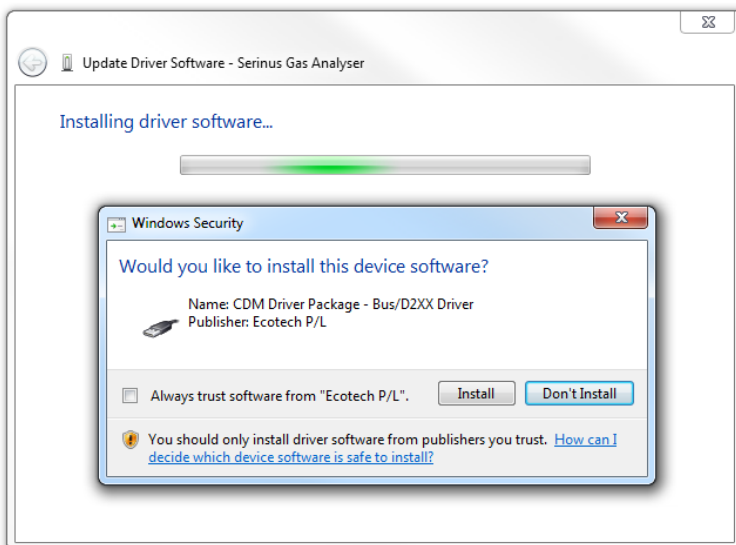

Figure 24 – Installing Driver Confirmation Prompt

If everything went smoothly, Windows will inform you that the driver was successfully installed.

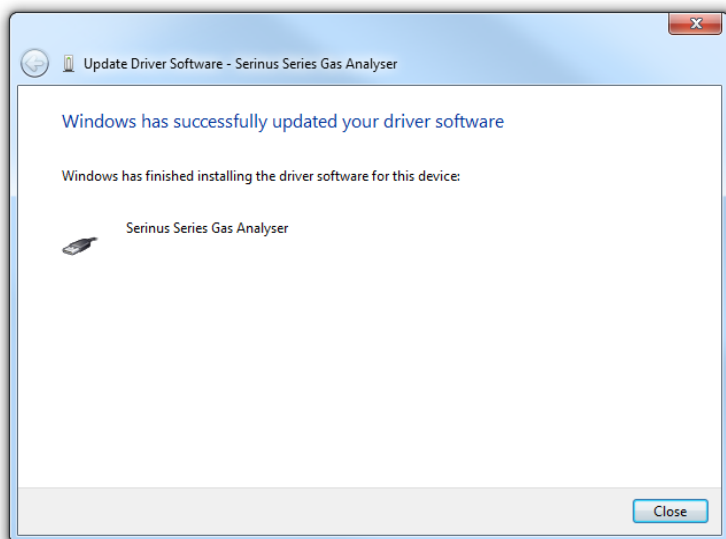

Figure 25 – Successful Driver Installation

4.6.1.2 Connecting Over Serial (RS-232)

The following steps outline how to setup the instrument for connection to a PC or datalogger (refer to Section 3.4.22).

Procedure

1. Open - **Main Menu** → **Communication Menu** → **Serial Communication Menu**.
2. Determine which RS232 Port you are physically making the connection with. Remember, multidrop is only supported on RS232 #2.
3. Select – **Baudrate** → **38400** - Accept (Set an appropriate baud rate, default is 38400).

4. Select - **Protocol** → **Advanced** - Accept.

If you are running Airodis in a multidrop configuration, ensure that the **Serial ID** is unique for each instrument on the chain.

4.6.1.3 Connecting Over Network (TCP/IP)

The following steps outline how to setup the instrument for connection to a PC or datalogger (refer to Section 3.4.27).

Procedure

1. Open - **Main Menu** → **Communication Menu** → **Network Menu**.
2. Select - **Protocol** → **Advanced** - Accept.
3. Select - **Start-up Mode** → **Set IP** - Accept.
4. Assign a unique static IP address to the instrument.
5. Reboot the instrument by cycling the power.

4.6.2 Installing Airodis

The user can download data from the instrument using either a full retail (paid) version of Airodis or with the demo version which is included on the green Ecotech resources USB stick. The demo version has limited functionality, but will allow you to download and export data from up to three instruments. If you do not already have Airodis, this can be obtained from Ecotech:

<http://www.airodis.com.au>

The installer is straightforward: Ensure you install the correct version for your operating system. If you are running 64-bit windows, install the 64-bit (x64) version. Otherwise, install the 32-bit (x86) version.

4.6.3 Configuring Airodis

1. Once installed, double click on the Airodis shortcut on the desktop to start Airodis Workspace Manager. You will be presented with the default workspace options. These will suffice for downloading data from the instrument.

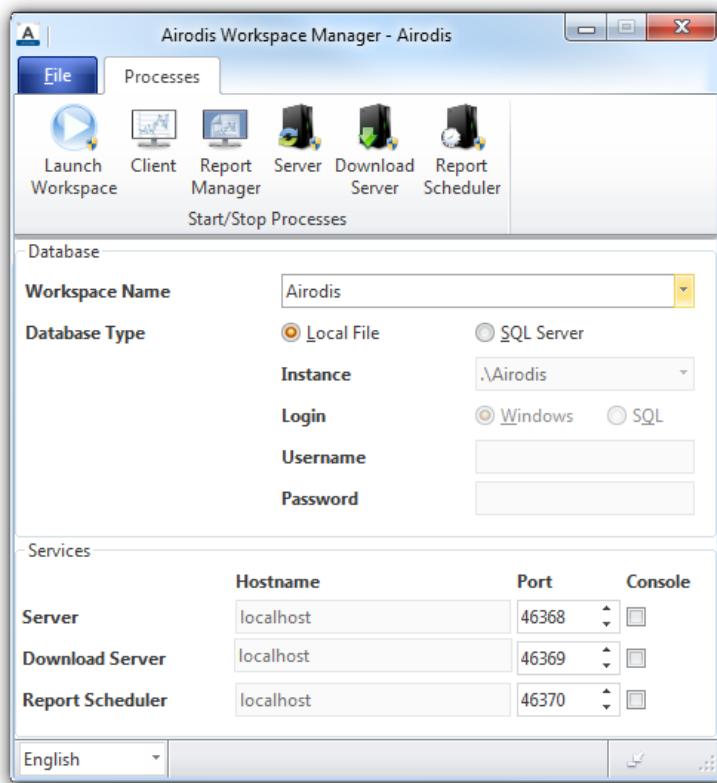

Figure 26 – Airodis Workspace Manager

2. Start the Client, Server and Download Server by single-clicking the toggle button for each. The client may prompt to register with Ecotech or install an update. Follow the prompts if it does.
3. Once the Client application has loaded, click **Home**→**Add Station**→**New Physical Station**.

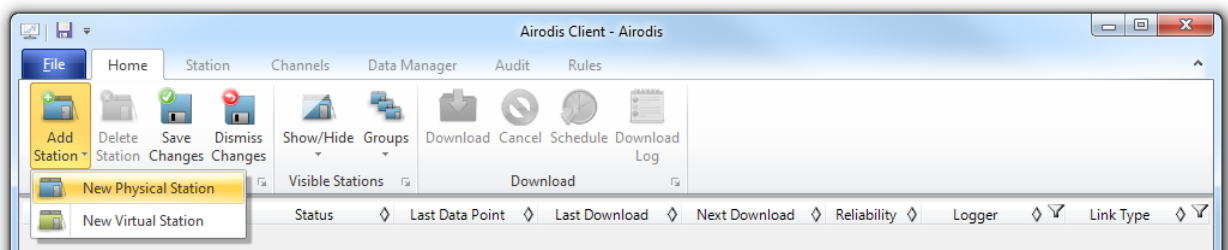

Figure 27 – Adding a New Station

4. This automatically brings you to the **Station** tab on the ribbon. Enter the communication details to connect to the instrument.

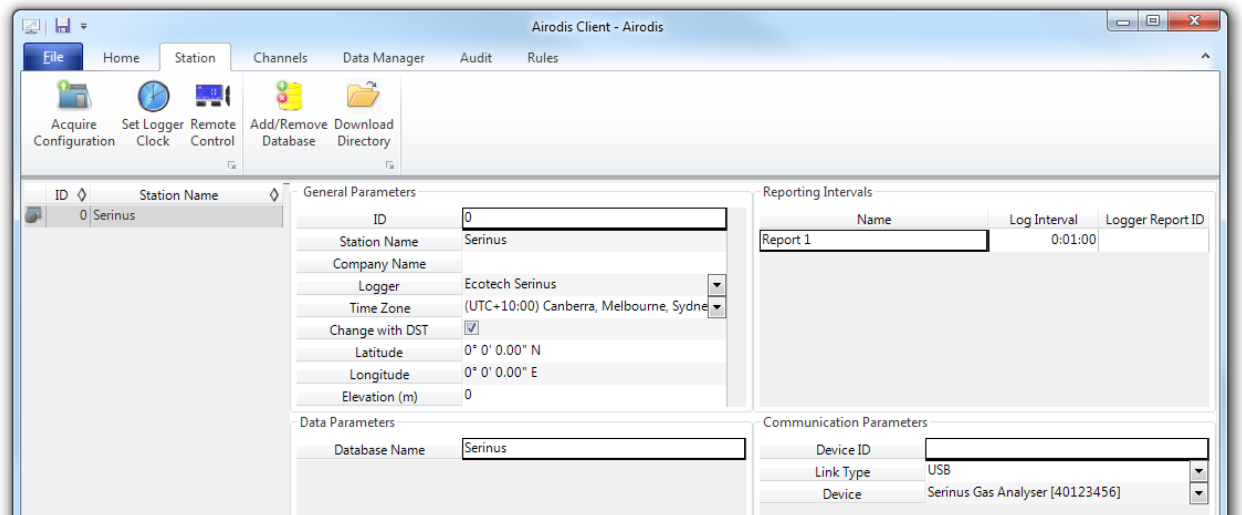

Figure 28 – Adding a New Station

Table 5 – Setting up a New Station via Airodis

Property	Description
Station Name	The name of the station. If you have other loggers, the name is used to distinguish them.
Logger	Set this to “Ecotech Serinus” when downloading from any Serinus series instrument. This will communicate with the instrument via the Advanced protocol. If using a network or serial connection, ensure that the Advanced protocol has also been selected on the instrument itself.
Time Zone	Set this to the time zone that the instrument is located in.
DST	Enable this option if you plan on changing the clock on the instrument with daylight savings. Leave this disabled if the clock does not shift during DST. The instrument will need to be adjusted manually for DST – it will not happen automatically.
Database Name	This is the name to be used for the table in the SQL database containing this station’s data. It must be unique for each station.
Device ID	Enter the Serial ID of the instrument. If you are not using multidrop; this can be set to “0” or left blank.
Link Type	Select the type of connection used to connect to the instrument. Different properties will appear depending on the link type selected. Align these settings with those of the instrument.
Log Interval	This needs to be the same as the Data Log Interval setting on the instrument.

Note: The available fields for communication parameters will change when you change the link type. You will need to set the communication parameters that have been defined on the instrument.

- Once the station has been created, save the station by clicking the Save shortcut icon or **File→Save**.
- Click Acquire Configuration. This will probe the instrument for a channel list. After a few seconds, the channel list should be visible in the Channels tab.

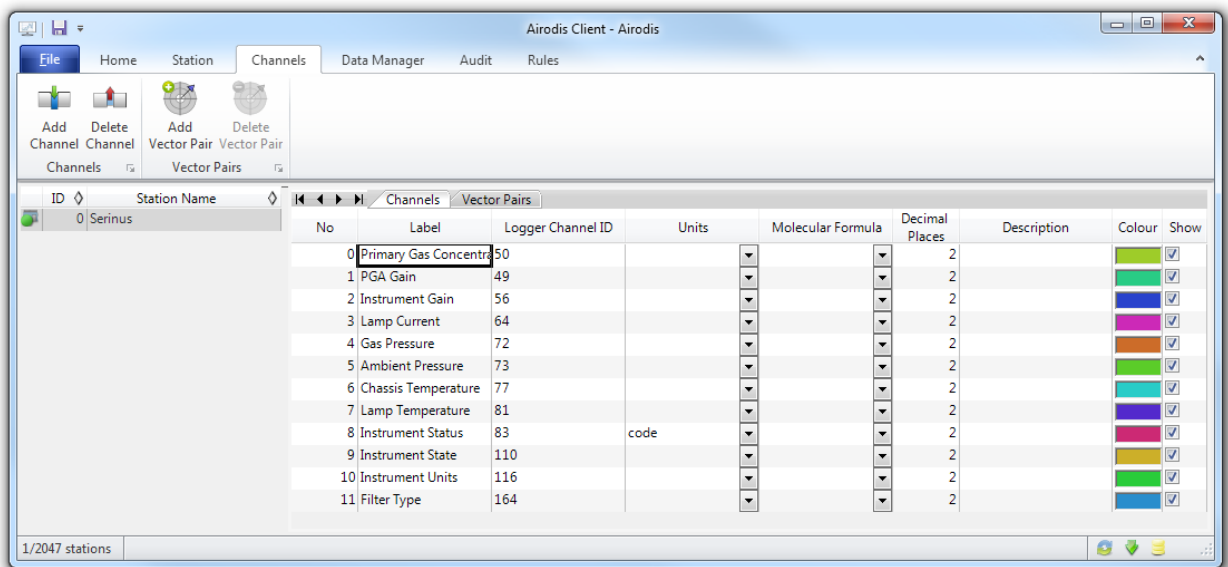

Figure 29 – Station Configuration (Channel List)

Note: If there was an error connecting to the instrument, a red dot will appear next to the station name in the station list (on the far left hand side). Hovering over the red dot will present you with an error message (refer to Figure 30).

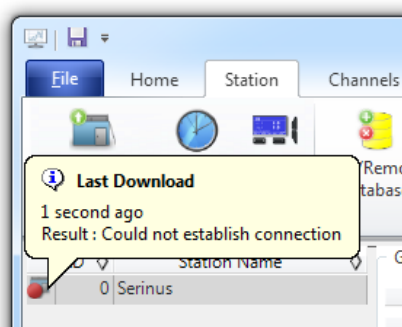

Figure 30 – Error Status Notification

7. Select the Data Manager tab, click download. The Download Data window will appear. Select the appropriate time period that you wish to download and click Download.

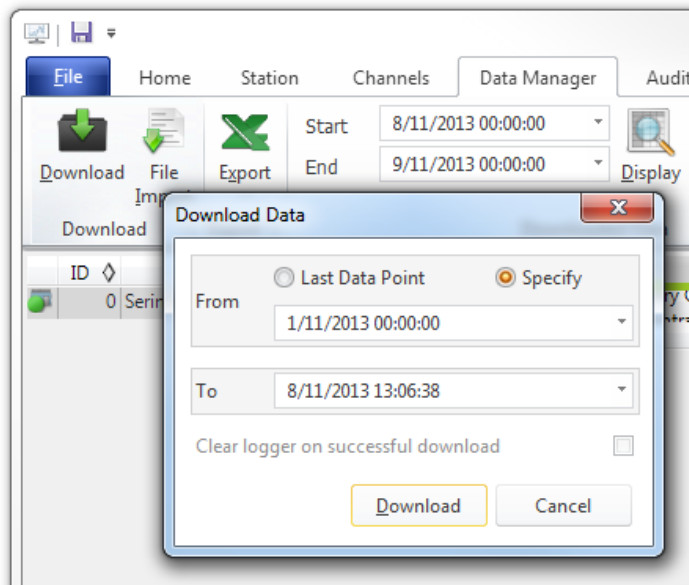

Figure 31 – Downloading Data

8. The status of the download will appear in the bottom-left corner of the window. You can also monitor the status of the download from the Home tab.

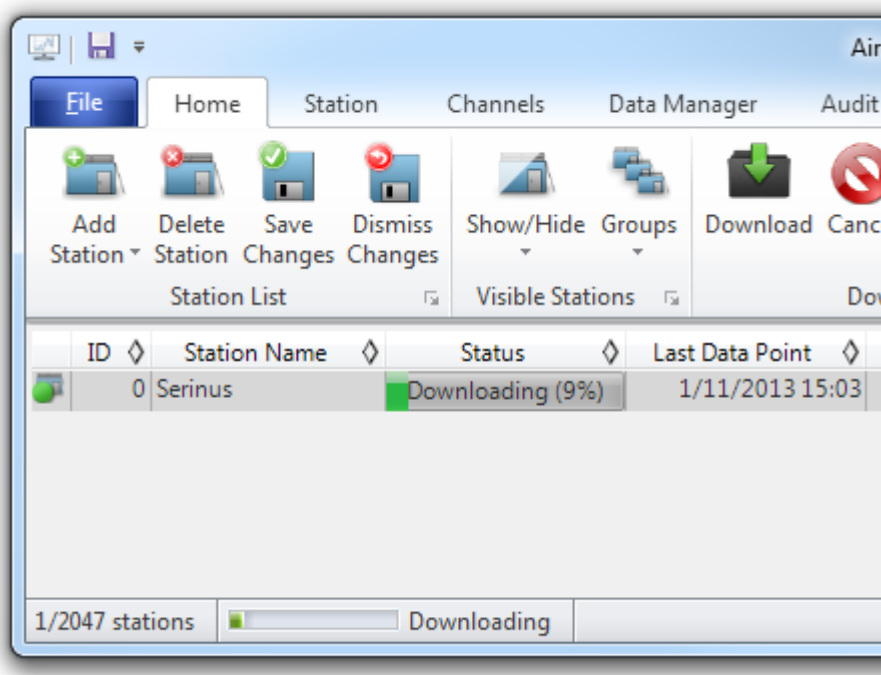

Figure 32 – Download Data Status

9. Data will become available in the data manager as it is downloaded. You can load data for a date range by entering the start and end dates and clicking Display. The selected data will be loaded into the data manager.

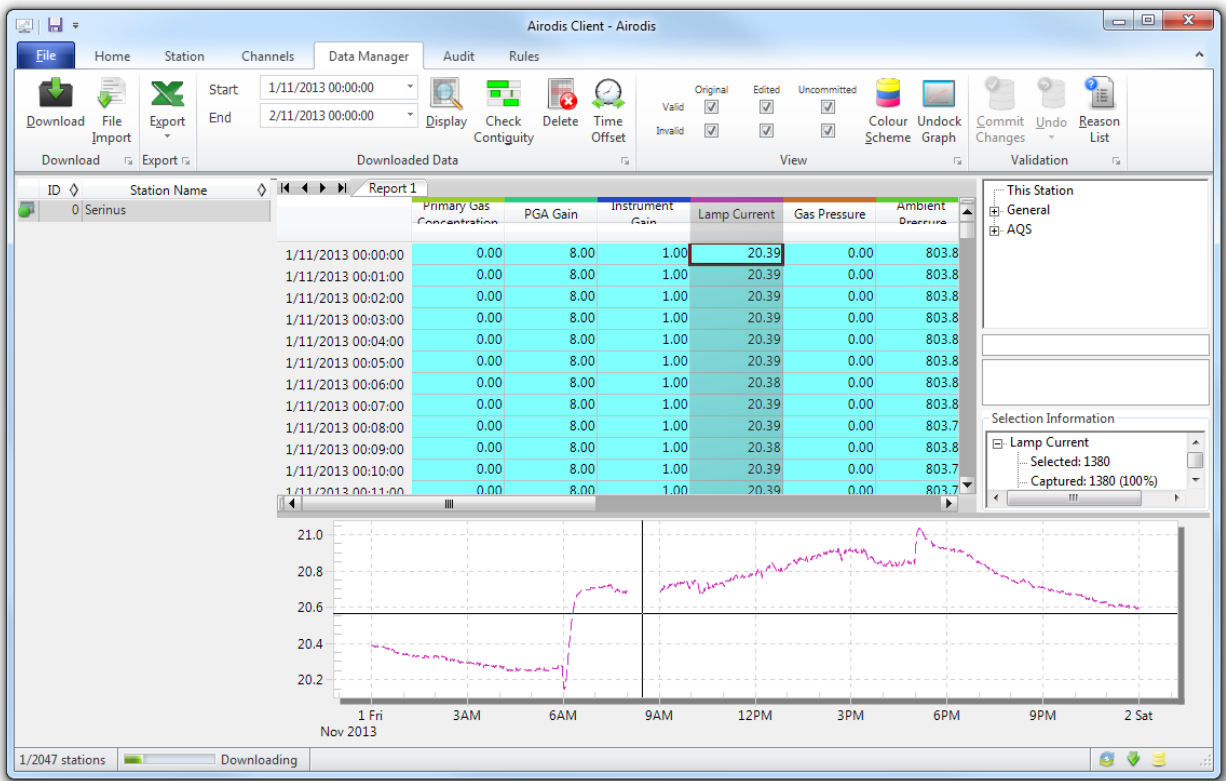

Figure 33 – Data Visibility

10. Data can be exported by clicking the Export function. This will allow you to save your data in CSV format, which can be loaded into another program such as Microsoft Excel. It is also possible to copy/paste (Ctrl + C / Ctrl + V) data directly from the Airodis data manager.

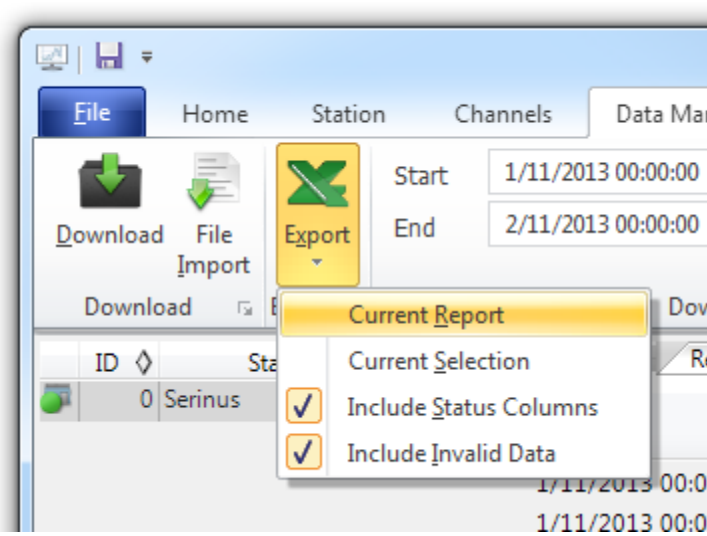
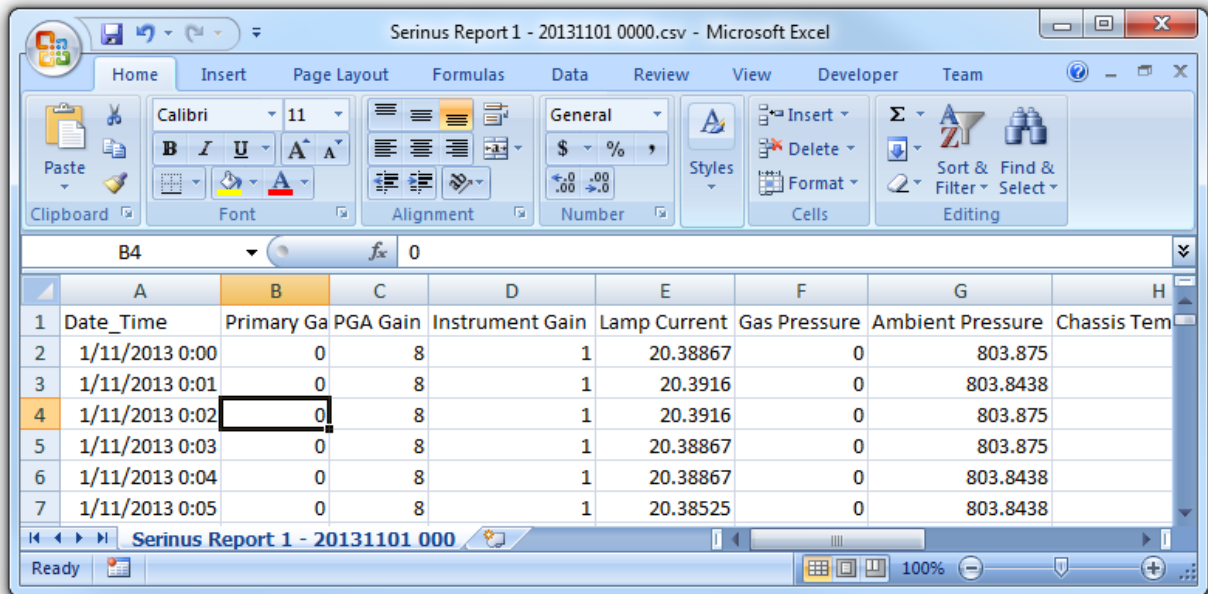

Figure 34 – Exporting Data

11. That's it! The data has been downloaded from the instrument and exported to a standard CSV file.



	A	B	C	D	E	F	G	H
1	Date_Time	Primary Ga	PGA Gain	Instrument Gain	Lamp Current	Gas Pressure	Ambient Pressure	Chassis Tem
2	1/11/2013 0:00	0	8	1	20.38867	0	803.875	
3	1/11/2013 0:01	0	8	1	20.3916	0	803.8438	
4	1/11/2013 0:02	0	8	1	20.3916	0	803.875	
5	1/11/2013 0:03	0	8	1	20.38867	0	803.875	
6	1/11/2013 0:04	0	8	1	20.38867	0	803.8438	
7	1/11/2013 0:05	0	8	1	20.38525	0	803.8438	

Figure 35 – Data Download Complete

4.7 Serinus Remote App/Bluetooth

The Serinus Remote Application allows for any Android device (Tablet or Smartphone) to connect to an instrument.

The Serinus Remote Application allows the user to:

- Completely control the instrument using a remote screen displayed on the device.
- Download logged data and take snapshots of all the instrument parameters.
- Construct graphs from logged data or real time measurements.

The following sections cover installation, connection and use of the application.

4.7.1 Installation

The Serinus Remote Application can be found in the Google Play Store by searching for Ecotech or Serinus. Once found, choose to Install the application and Open to start the application.

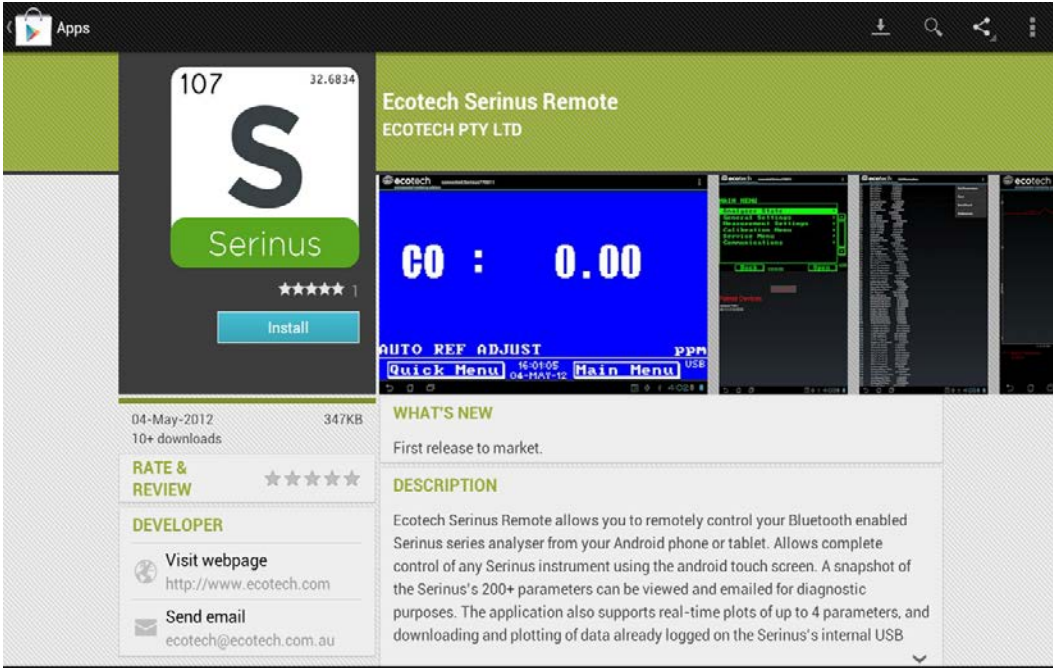

Figure 36 – Downloading the App from Google Play Store

Note: A menu containing additional features and functions can be accessed by entering the Options Menu (or similar) on your device. The location and format of this menu may vary.

4.7.2 Connecting to the Instrument

Procedure

1. Open - **Main Menu** → **Communications Menu** → **Bluetooth Menu** (to find the Bluetooth ID and PIN) (refer to Section 3.4.28).
2. Touch the Scan Serinus Analysers button at the bottom of the screen.
3. Select the Analyser ID from either the Paired Devices or the Other Available.
4. Input the PIN (if prompted) and press OK (refer to Section 3.4.28).

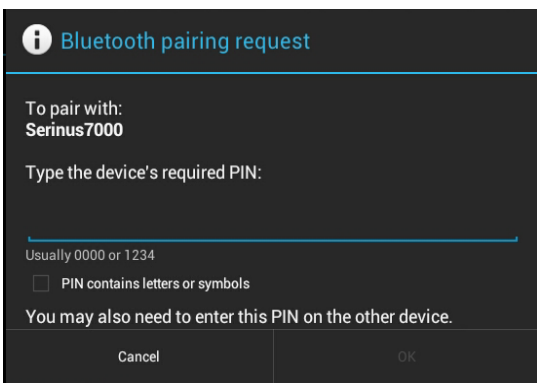

Figure 37 – Bluetooth Pairing Request

5. A screen shot of the instrument's current screen should appear on your Smartphone or tablet. To disconnect press the back key/button on the device.

Note: Once the instrument has been paired with the device it will appear under “Paired Devices” and the PIN will not need to be entered again. Only one Bluetooth connection can be made to an instrument at any one time.

4.7.3 Instrument Control

Once connected the user has full control of the instrument. The range for remote control depends on the device’s Bluetooth capabilities and any intervening obstructions, but is usually up to 30 meters.

Remote Screen Operation

With the exception of the number pad, all button functions/actions can be performed by touching the screen. This includes the selection buttons and the scroll buttons. Touching any part of the screen where there is not already a button also enacts the functions of the scroll buttons.

Home Screen

Touching the upper half of the screen increases the contrast and touching the lower half of the screen decreases contrast on the real instrument.

Menus

Touching the upper or lower half of the screen allows the user to scroll up and down respectively.

Right-hand Section of the Screen

Swiping from right to left brings up the number pad for entering numbers (swipe from left to right to hide the number pad).

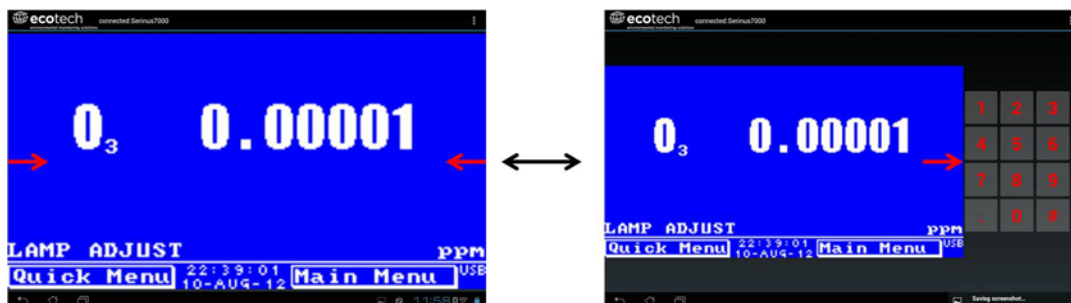

Figure 38 – Showing or Hiding the NumPad

Left-hand Section of the Screen

Swiping from left to right brings up a list of available analysers (swipe from right to left to hide the instrument list).

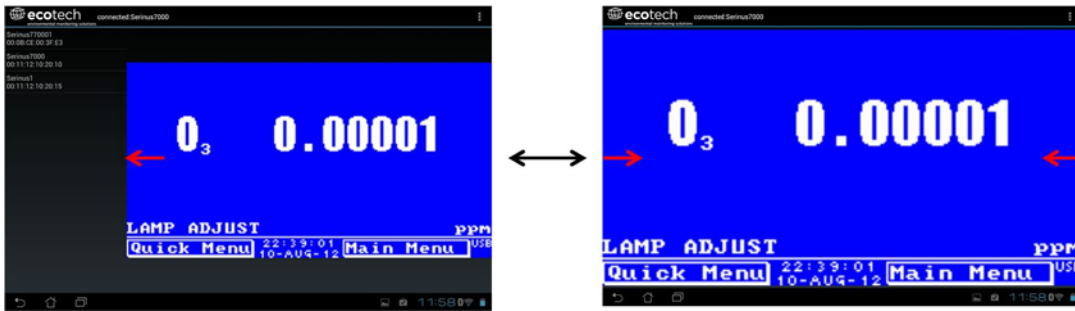

Figure 39 – Switching Analysers

Back Button

This button will enable the user to return to the selection screen, allowing connection to a different instrument.

Options Menu

The Options Menu is accessed by the grey button in the top right corner of the screen or pressing the Menu Button, depending on the Android device.

Refresh	Refresh the display.
Show/Hide NumPad	Show or hide the number pad.
Real Time Plot	Refer to Section 4.7.4.
Download	Refer to Section 4.7.5.
Get Parameters	Refer to Section 4.7.6.
Preferences	Refer to Section 4.7.7.

4.7.4 Real-Time Plot

Allows the user to view real-time plotting of up to four parameters at the same time. The user can also scroll from left to right, top to bottom or zoom in and out on the plot by swiping/pinching.

Once the plot is zoomed or scrolled, it enters into Observer Mode, meaning that auto-scaling is suspended. Press at the top of the screen (where it says Observer Mode) to return to Normal Mode.

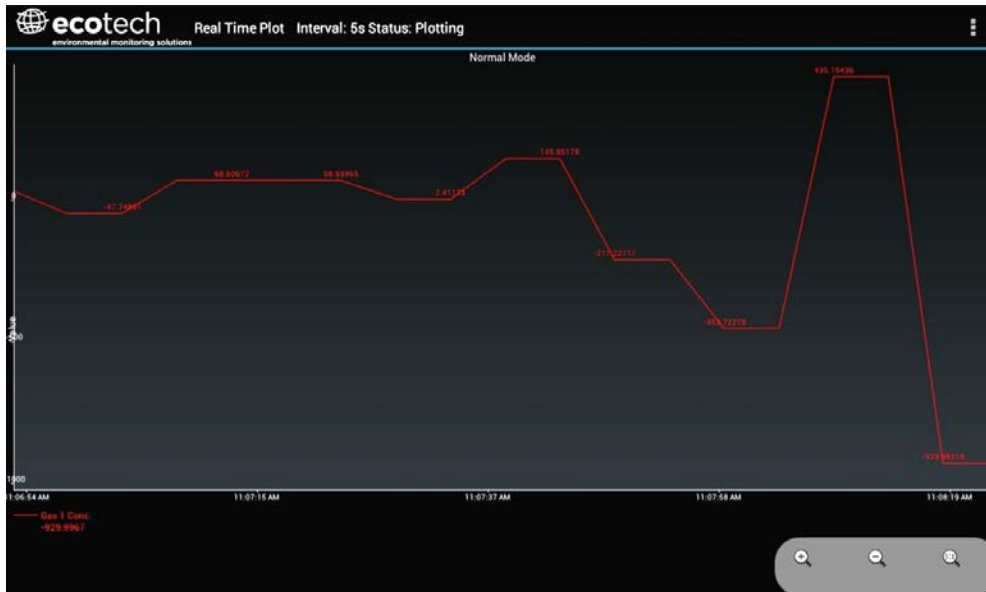

Figure 40 – Real-Time Plot

Options Menu

The Options Menu is accessed by the grey button in the top right corner of the screen or pressing the menu button, depending on your Android device.

Start	Restarts graphing if it has been stopped and returns the graph to Normal Mode .
Stop	Stops collecting data. In this mode you can scroll the display without going into Observer Mode , because the system has no data collection to suspend. It is necessary to “Stop” data collection to set the interval.
Clear	Clears the window and restarts the graphing.
Save	Saves an image of the graph and accompanying data in the location specified in preferences (refer to Section 4.7.7). The user will also be asked whether they want to send the file and data via email. When saving the data, you can choose to Save All Data or Customise the length of the data by entering a time between five minutes and six hours. Only the data from the start of collection to that limit will be saved (although the plot will still appear exactly as it does on the screen).
Set Interval	While data collection is stopped, the user can specify the time intervals between collections.

4.7.5 Download

Download logged data from the USB memory stick inside the instrument. All data logged by the instrument to the USB memory stick over the period of time specified will be collected. Due to the slow connection speed of Bluetooth, this should only be used for relatively short sections of data. Downloading one days’ worth of one minute data is likely to take a couple of minutes.

Options Menu

Save	Generates a filename based on the start and end date/time specified. It saves the downloaded data in the location specified in preferences and asks to send the saved comma separated text file (.csv) as an attachment to an email. This file format does not include the parameter headings, just the values.
Send E-Mail	Sends an email with the parameter data in the body of the email, formatted as displayed (this includes the parameter name and the values).
Plot	Graphs the data that has been downloaded. The user is prompted to select which parameters to plot based on the parameters that were being logged (refer to Figure 41).
Preferences	Refer to Section 4.7.7.

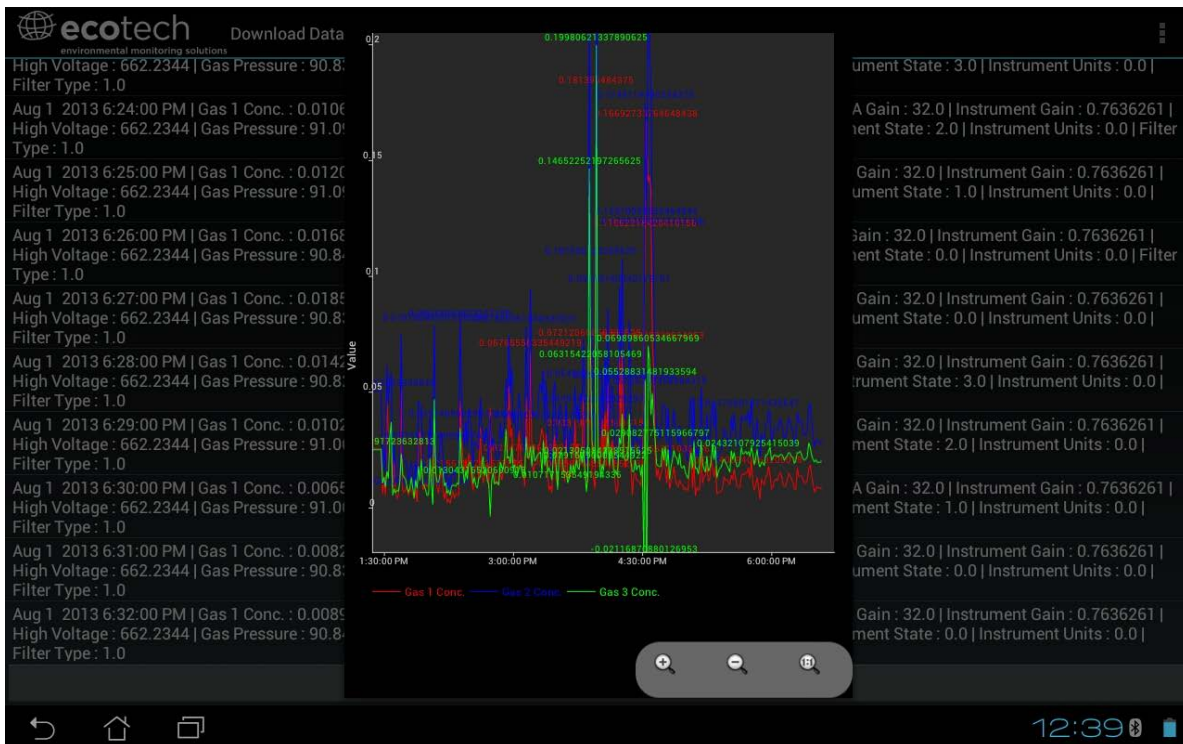

Figure 41 – Plot of Downloaded Data

4.7.6 Get Parameters

Download a list of parameters and corresponding values directly from the instrument. This list of parameters is a snap shot of the current instrument state and is very helpful in diagnosing any problems with the instrument.

Options Menu

Get Parameters	Refreshes the parameter list display.
Save	Generates a file name from the current date and time, saves the parameter data in the location specified in preferences and asks to send the saved text file as an attachment to an email.
Send E-Mail	Sends an email with the parameter data in the body of the email, formatted as displayed.

Get Parameters	Refreshes the parameter list display.
Preferences	Refer to Section 4.7.7.

4.7.7 Preferences

The Preferences Menu allows the operator to adjust the directory settings, logged data format and the colour scheme settings. It can be accessed through the Options Menu in most windows.

Directory Settings

The operator can specify/select where to save the parameter lists, logged data and real time plots.

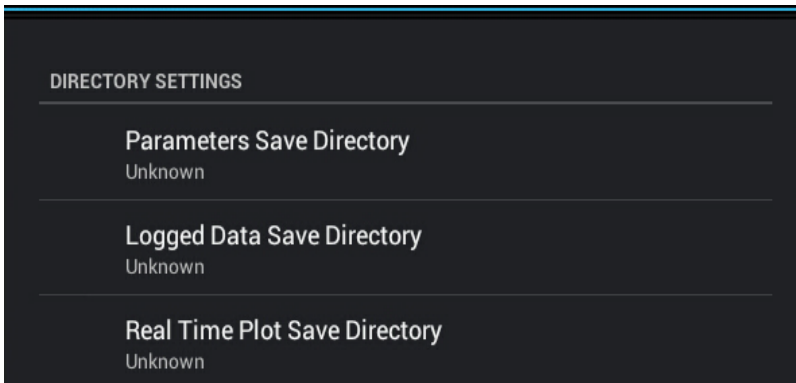

Figure 42 – Directory Settings

Logs Format

When downloading logged data, the parameters can be displayed on one line or each parameter on a separate line.

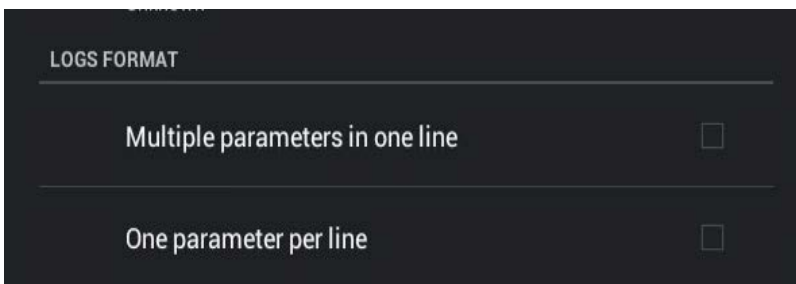

Figure 43 – Logs Format

Colour Theme Settings

Allows the user to choose a colour scheme for the remote screen, either Matrix, Classic, Emacs or Custom.

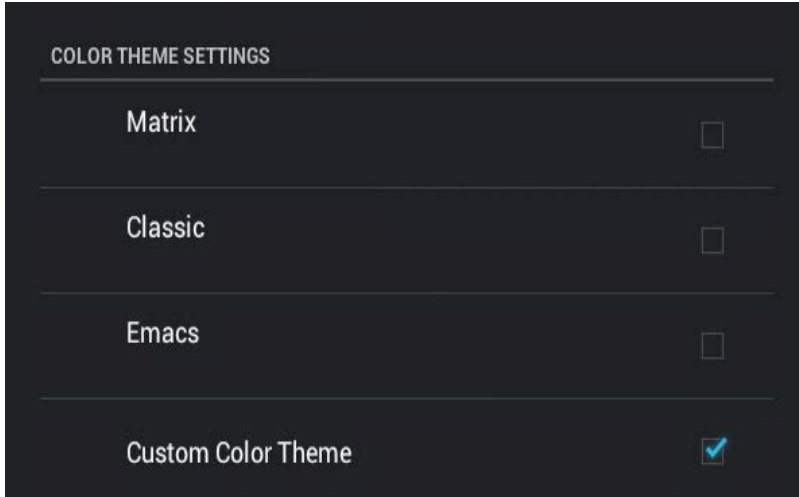

Figure 44 – Colour Theme Settings

5. Calibration

The following sections describe how to calibrate the span and zero points of the instrument as well as giving a brief overview of the calibration system.

Main Menu → Calibration Menu (refer to Section 3.4.10).

5.1 Overview

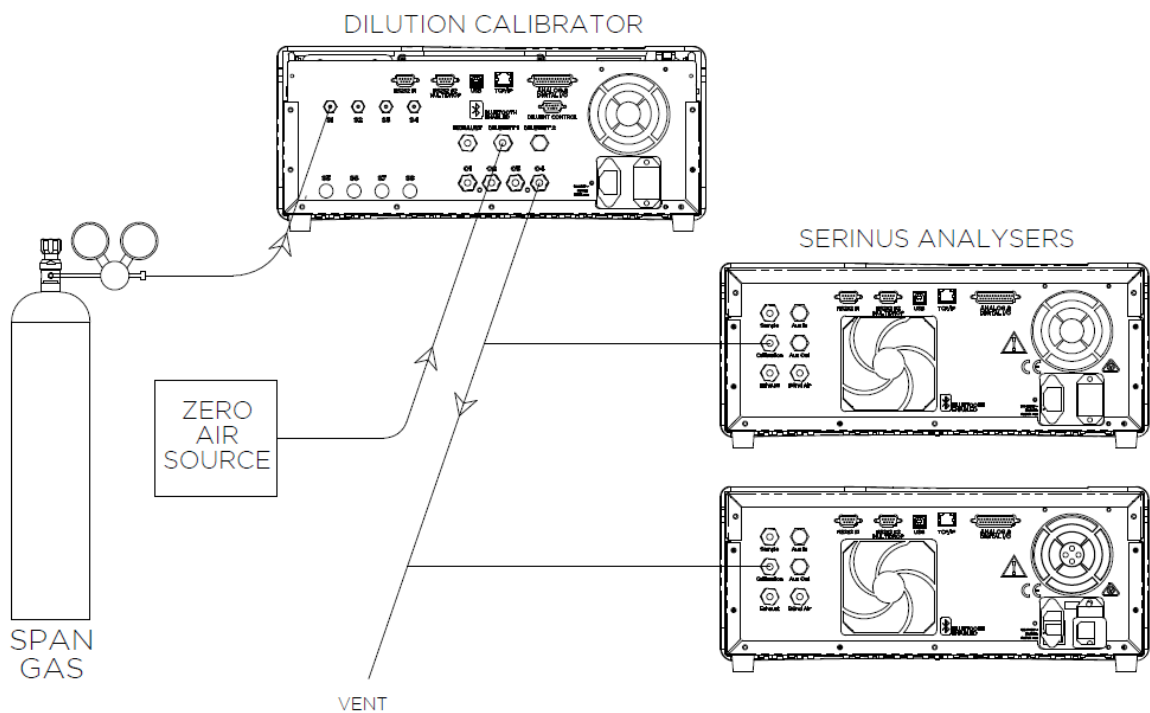



Figure 45 – Example of a Calibration System



CAUTION

All calibration gases **must** be supplied at ambient pressure to avoid damaging the instrument. If direct gas cylinder connection is required, high pressure Span/Zero options can be installed at time of ordering.

The calibration chapter consists of a:

- General discussion of calibration.
- Description of the pressure calibration procedure.
- Description of the Zero, Span and precision check calibration procedures.

- Description of the multipoint precision check procedure.
- Description of the H₂S converter efficiency checks procedure.

The Serinus 51 analyser is a precision measuring device which must be calibrated against a known source of SO₂ and the efficiency of the converter checked against H₂S a certified gas cylinder.

There are several different types of checks/calibrations performed:

- Level 1 Calibration – A simplified two-point instrument calibration used when instrument linearity does not need to be checked or verified. This check is typically performed on a monthly basis. Adjustments to the instrument response can only be made when performing level 1 calibration.
- Level 2 Calibration – A simple check of the instrument's response. Level 2 checks may be performed using non-certified reference sources and are most often used as a performance monitoring tool. The instrument may not be adjusted
- Multipoint Precision Check – A series of calibration points, typically covering zero and 4 up-scale points, measured using a certified reference atmosphere and covering the instruments FS measurement range. These precision checks are used to determine the linearity of the instrument response across its measurement range.
- Converter Efficiency Check – A measure of the efficiency of the system to convert the target gas for subsequent measurement. A converter efficiency check is performed on a regular basis to determine converter performance and adjust the instrument response accordingly.

In general terms, the calibration process includes the following steps:

1. Establish a reliable and stable calibrating source.
2. Provide a satisfactory connection between the calibration source and the instrument.
3. Calibrate the analyser against the calibration source.

Multipoint precision check is used to establish the relationship between instrument response and pollutant concentration over the instrument's full scale range. Zero and span calibrations are frequently used to provide a two-point calibration or an indication of instrument stability and function.

Note: Zero calibrations are not recommended by Ecotech, but maybe be performed when specifically required by a user. Zero calibrations tend to mask issues that should be addressed during maintenance/service.

Regulations generally require that the analyser be span calibrated any time;

- The instrument is moved.
- The instrument is serviced.
- When changing the instruments units between volumetric and gravimetric.
- Whenever the instrument characteristics may have changed.

5.2 Pressure Calibration

The pressure sensors are a vital component of the instrument operation and the pressure calibration should be checked on installation or whenever maintenance is performed.

A thorough leak check must be performed prior to performing a pressure calibration (refer to Section 6.3.4).

The pressure calibration can either be a two point calibration (one point under vacuum and another point at ambient pressure) or a single ambient point calibration when very minor adjustments are required.

Note: Ensure that the instrument has been running for at least one hour before any calibration is performed to ensure the instrument's stability. When performing a two point pressure calibration, it is advisable to perform the vacuum pressure calibration first.

5.2.1 Full Pressure Calibration

This section outlines how to perform a full pressure calibration. Using the required equipment follow the steps below to complete a full pressure calibration.

Note: Ensure that the instrument has been running for at least one hour before the calibration is performed.

Note: Ensure units of measure are the same on both the barometer and instrument.

Equipment Required

- Barometer
- Vacuum source

Procedure

1. Disconnect any external tubing connected to the rear of the instrument.
2. Open - **Main Menu** → **Calibration Menu** → **Pressure Calibration Menu** - (read note) - OK.

Note: This action will place the valve sequencing on hold; normal sampling will be interrupted.

3. Edit - **Vacuum Set Pt.** - (Read displayed instructions) - OK.
4. Connect a vacuum source to **Exhaust Port** (refer to Figure 7) of instrument.
5. Using a T-piece, connect a barometer to one end of the T-piece and use tubing to connect the **Sample Port** and **Aux In Port** to the other ends of the T-Piece.
6. Block the **BGnd Air Port**, wait 2-5 minutes and ensure the pressure reading on the barometer has dropped and is stable.
7. Enter the barometer reading into the instrument - Accept.
8. Read displayed instructions - OK.

- Turn off the vacuum source and slowly remove the barometer from the **Sample Port** then remove the blocker from the **BGnd Air Port** and allow the instrument to return to ambient. Disconnect the vacuum line from the **Exhaust Port**.
- Wait 2-5 min, enter the ambient barometer reading into the instrument - Accept.

Note: Both of the pressure sensors should now be displaying the current ambient pressure and they should be the same value within 3 torr of each other.

- Back - **Pressure Calibration Menu** - (read note) - OK.

5.2.2 Ambient Point Pressure Calibration

Full pressure calibrations are generally recommended, however it is possible to calibrate only the ambient point in cases where only a minor ambient pressure adjustment is required.

Note: Ensure that the instrument has been running for at least one hour before any calibration is performed to ensure the instrument's stability.

Note: Ensure units of measure are the same on both the barometer and instrument.

Equipment Required

- Barometer

Procedure

- Disconnect all external tubing connected to the rear ports of the instrument.
- Open - **Main Menu** → **Calibration Menu** → **Pressure Calibration Menu** - (read note) - OK.

Note: This action will place the valve sequence on hold; normal sampling will be interrupted.

- Edit - **Ambient Set Pt.** - (Read displayed instructions) - OK.
- Disconnect any external tubing connected to the rear ports of the instrument (**Sample Port**, **Exhaust Port**, etc.).
- Wait 2-5 minutes and enter the ambient barometer reading into the instrument - Accept.

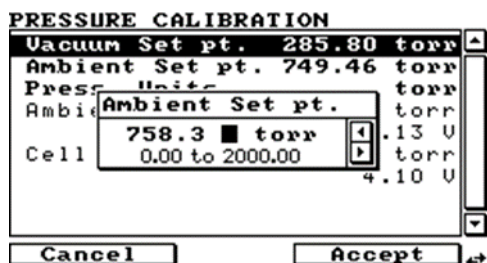

Figure 46 – Setting the Ambient Set Point

Note: Both of the pressure sensors should now be displaying the current ambient pressure and they should be the same value within 3 torr of each other.

6. Back - **Pressure Calibration Menu** - (read note) - OK.

5.3 Zero Calibration

Zero calibrations are used to determine the zero response of the instrument and apply an offset to the reading.

Performing a zero calibration will adjust the **Zero Offset SO2**. This offset can be checked in the **Main Menu → Service Menu → Calculation Factors Menu** and should be very close to zero. A large offset may indicate a problem with the instrument (refer to Section 7).

Note: Ecotech encourages regular zero precision checks; however Ecotech recommends that the zero calibration only be performed when specifically required as it may mask issues that should be addressed during maintenance/service.

A zero calibration can be performed either through the **Calibration Port**, **Background Air Port** or the **Sample Port**. Refer to the instructions outlined in the next three sections:

5.3.1 Calibration Port

Equipment Required

- Zero source

Procedure

1. Ensure a suitable zero source is connected to the **Calibration port**.
2. Open - **Main Menu → Calibration Menu**.
3. Select - **Cal. Type → Manual** - Accept.
4. Select - **Zero Source → External** - Accept.
5. Select - **Cal. Mode → Zero** - Accept.
6. Allow the instrument time to achieve a stable response.
7. Enter - **Zero Calibrate SO2** - OK.
8. Select - **Cal. Mode → Measure** - Accept (To return to sample measure).

5.3.2 Sample Port

Equipment Required

- Zero source

Procedure

1. Ensure a suitable zero source is connected to the **Sample Port**.
2. Open - **Main Menu → Calibration Menu**.
3. Select - **Cal. Type → Manual** - Accept.

4. Select - **Zero Source** → **External** - Accept.
5. Select - **Cal. Mode** → **Measure** - Accept.
6. Allow the instrument time to achieve a stable response.
7. Enter - **Zero Calibrate SO2** - OK.
8. Disconnect the zero source and reconnect the sample line to the **Sample Port**.

5.3.3 Background Air Port

Equipment Required

- N/A

Procedure

1. Open - **Main Menu** → **Calibration Menu**.
2. Select - **Cal. Type** → **Manual** - Accept.
3. Select - **Zero Source** → **Internal** - Accept.
4. Select - **Cal. Mode** → **Zero** - Accept.
5. Allow the instrument time to achieve a stable response.
6. Enter - **Zero Calibrate SO2** - OK.
7. Select - **Cal. Mode** → **Measure** - Accept (To return to sample measure).

5.4 Span Calibration

A span calibration is a calibration performed at the upper end of the instrument's measurement range. Ecotech recommends calibration at 80% of the full scale measurement or operating range of the instrument.

While the instrument range is commonly set as a default 0-500 ppb, this is widely recognised as no longer being valid with modern digital communication and most regulators will now recommend a range more suited to local conditions.

A span gas can be supplied through either the **Calibration Port** or **Sample Port**. Refer to the instructions outlined in the next two sections.

Note: Ensure that the instrument has been running for at least one hour before any calibration is performed to ensure the instrument's stability.

5.4.1 Calibration Port

Equipment Required

- Span source

Procedure

1. Ensure a suitable span source is connected to the **Calibration Port**.

2. If diluting the gas with a dilution calibrator, set the output concentration to 80% of the instrument measurement range.
3. Open - **Main Menu** → **Calibration Menu**.
4. Select - **Cal. Type** → **Manual** - Accept.
5. Select - **Cal. Mode** → **Span** - Accept.
6. Let the instrument stabilise, typically 15 minutes (depending on user setup).
7. Enter - **Span Calibrate SO₂** - (Enter the span output concentration) - Accept.
8. Select - **Cal. Mode** → **Measure** - Accept (To return to sample measure).

5.4.2 Sample Port

Equipment Required

- Span source

Procedure

1. Ensure suitable span source is connected to the **Sample Port**.
2. If diluting the gas with a dilution calibrator, set the output concentration to 80 % of the instrument measurement range.
3. Open - **Main Menu** → **Calibration Menu**.
4. Select - **Cal. Type** → **Manual** - Accept.
5. Select - **Cal. Mode** → **Measure** - Accept.
6. Let the instrument stabilise, typically 15 minutes (depending on user setup).
7. Enter - **Span Calibrate SO₂** - (Enter the span output concentration) - Accept.
8. Disconnect the span source and reconnect the sample line to the **Sample Port**.

5.4.3 Manual Instrument Gain and Offset Adjustments



CAUTION

Manual adjustment of the Instrument Gain does not take into account the PTF correction and can lead to an incorrect calibration

At times it may be desirable to manually adjust the instrument's gain and offset. Typically this option is only used when an instrument calibration has been corrupted and the user wishes to reset the instrument response factors prior to performing a new calibration.

To manually adjust the instrument follow the below procedure:

1. Open - **Main Menu** → **Service Menu** → **Calculation Factors Menu**.
2. Edit - **Instrument Gain** - (Adjust as required. 1 is the default) - Accept.
3. Edit - **Zero Offset SO₂** - (Adjust as required. 0 is the default) - Accept.

5.5 Precision Check

Similar to a normal zero or span calibration, a precision check is a *Level 2 calibration* that may be performed using a non-certified reference. The instrument is supplied with a known concentration of span gas (or zero air) and the instrument's response observed. However, no adjustment to the instrument response is made during a precision check.

Note: Ensure that the instrument has been running for at least one hour before any calibration is performed to ensure the sufficient stability.

Equipment Required

- Span source
- Zero source

Procedure

1. Supply the instrument with a zero source (refer to Section 5.3 for the procedure of setting up a zero, but do not do a **Zero Calibrate SO₂**).
2. Observe and record the measurement from the instrument.
3. Supply the instrument with a span source (refer to Section 5.4 for the procedure of setting up a span but do not do a **Span Calibrate SO₂**).
4. Observe and record the measurement from the instrument.
5. Check both readings against your local applicable standards.

If an instrument fails a span precision check (based on your local applicable standards), perform a span calibration (refer to Section 5.4).

If an instrument fails a zero precision check (based on your local applicable standards), resolve the issue referring to Section 6.

5.6 Multipoint Precision Check

A multipoint precision check is used to determine the linear response of the instrument across its operating range. The instrument is supplied with span gas at multiple known concentrations, typically a zero point and at least four up-scale points, spread across the operating range of the instrument. The observed concentrations are compared to expected values and the linearity of the instrument assessed against local applicable standards.

Note: The instrument is inherently linear and the instrument gain should **not** be adjusted at each individual point. Non-linearity indicates a problem with the instrument (refer to Section 7). Ensure that the instrument has been running for at least one hour before any calibration is performed to ensure the instrument's stability.

Several methods for producing multiple known concentrations are available to use, such as connecting multiple certified bottles at different concentrations. However, Ecotech strongly recommends the use of a dilution calibrator and a certified cylinder of SO₂ at an appropriate concentration (typically 40-100 ppm SO₂ balance in Nitrogen).

1. Connect your calibration system to the **Calibration Port** of the instrument (Ecotech recommends the Serinus Cal 1000 as a minimum, refer to Figure 45).
2. Generate and record the displayed span concentrations for (at least) 5 stepped points (of known concentrations) evenly spaced across the instrument measurement range (refer to the example below).
3. Then using a program such as MS Excel, create an X Y scatter plot of expected concentration versus the recorded instrument response and use linear regression to calculate the line of best fit and the correlation factor (R^2) – refer to the users local applicable standards.

Example for an instrument measurement range of 500 ppb:

- a. For the 1st concentration, set the gas dilution calibrator to supply **400 ppb SO₂** gas to the instrument.
- b. Allow the instrument to sample the calibration gas until a prolonged stable response is achieved (the amount of time this takes is impacted by the calibration setup) and record the instrument response.
- c. Repeat the above steps using concentrations of **300 ppb, 200 ppb, 100 ppb** and a **Zero** point.
- d. Graph the results and use linear regression to determine a pass or fail as per applicable local standards.

$$y = mx + c$$

Note: To highlight hysteresis errors, it is advisable to run the multipoint check in both *descending* and *ascending* order - refer to applicable local standards.

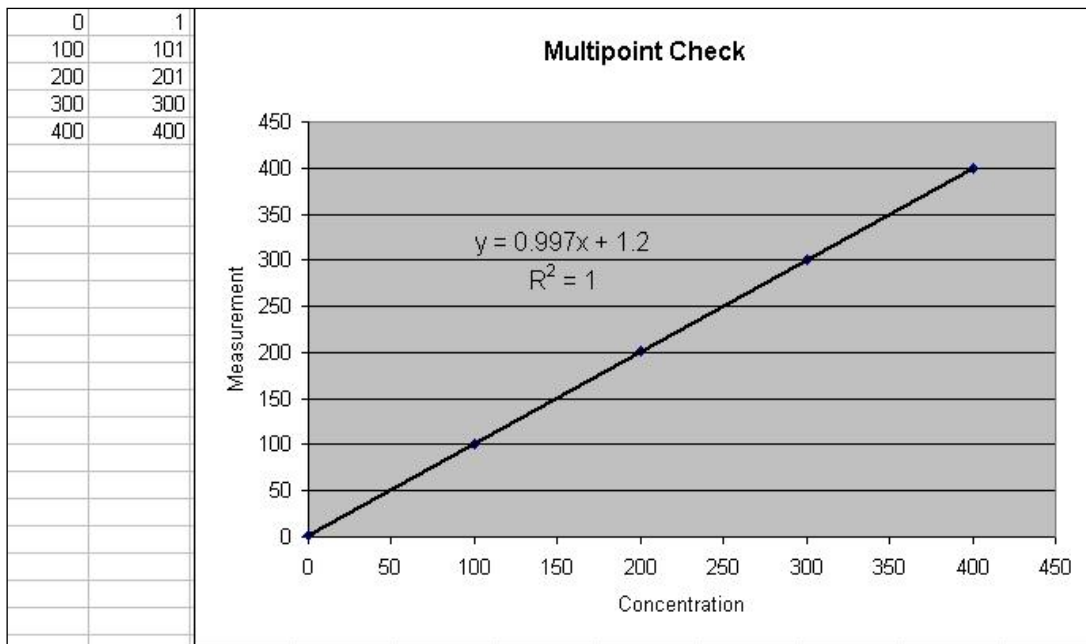

Figure 47 – Excel Graph of Multipoint Calibration

The following is a guide to approximate expected good results.

- e. The gradient (m) falls between 0.98 and 1.02.
- f. The intercept (b) lies between -2 and +2.
- g. The correlation (R^2) is greater than 0.99.

If unsatisfactory results are observed refer to Section 7.

5.7 H₂S Converter Efficiency Check

After a span calibration has been performed follow this procedure to accurately determine the H₂S (converter and selective scrubber) efficiency.

Equipment Required

- Gas Dilution Calibrator which can perform GPT (such as a Serinus Cal 1000)
- SO₂ Gas Standard
- H₂S Gas Standard
- Zero Air Generators

Procedure

1. Connect a source of H₂S span gas to the calibration port.
2. Open - **Main Menu** → **Calibration Menu**.
3. Note down the current value for **Conv. Efficiency H₂S**.
4. Edit - **Conv. Efficiency NO₂** - (change to 100%) - Accept.
5. Open - **Main Menu** → **Calibration Menu**.
6. Select - **Cal. Type** → **Manual** - Accept.
7. Select - **Cal. Mode** → **Span** - Accept.
8. Open - **Main Menu** → **Measurement Settings**.
9. Select - **Gas to Measure** → **H₂S** - Accept.
10. Set the span source to a known concentration (80% full scale recommended).
11. Allow H₂S readings to stabilize (60-90 minutes) and note down the H₂S concentration as displayed on the home screen.
12. Calculate the H₂S efficiency by dividing the noted concentration with the expected concentration, e.g. expected = 100ppb, recorded = 80 ppb.
 $80/100 = 80\%$ H₂S efficiency.
13. Open - **Main Menu** → **Calibration Menu**.
14. Edit - **Conv. Efficiency NO₂** - (change to new efficiency) - Accept.
15. Select - **Cal. Mode** → **Measure** - Accept.
16. Open - **Main Menu** → **Measurement Settings**.
17. Select - **Gas to Measure** → **Both** - Accept.

5.8 High Pressure Zero/Span Valve

If the instrument was ordered with this option, the internal pressurised calibration valves will already be installed within the instrument as either a zero or span calibration source, thus no other internal connections need to be made.

Note: Before using a high pressure span or zero as a source for calibrating the instrument, please check the local regulatory requirements. This is generally only be used as an operational check of the instrument's zero point and single span point (recommended as 80% of full scale).

5.8.1 Single Pressurised Calibration Option

Set-Up of Single Calibration Option

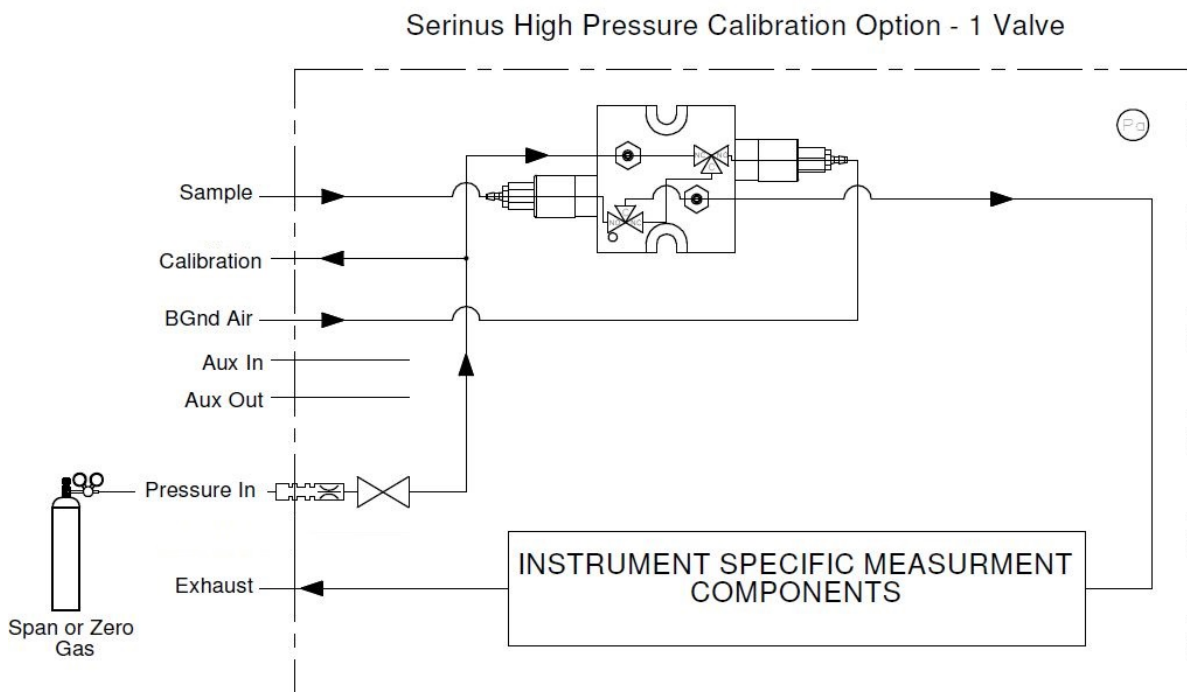

Figure 48 – Single High Pressure Calibration Option

When using the pressurised calibration option, either a high pressure zero or span cylinder (depending on the option you have ordered) should be connected to the **Pressure In Port**.

Equipment Required

- Calibrated Flow Meter
- Gas Cylinder

Procedure

1. Ensure the gas cylinder is fitted with an appropriate gas regulator with a shut off valve.
2. Connect a ¼" line of stainless steel tubing between the gas cylinder and the instruments **Pressure In Port**.

Note: This connection may need to be retightened during this operation.

3. Open the cylinder main valve and adjust the regulator to 15 psig.
4. Open the regulator's shutoff valve and test for leaks:
 - a. Pressurise the line.
 - b. Close the cylinder main valve.
 - c. If pressure drops by more than 2 PSI over five minutes, check the connections and retest.
 - d. Open cylinder main valve.
5. Temporarily place a flow meter on the **Calibration Port** (this port is now used as the high pressure calibration vent).
6. Open - **Main Menu** → **Calibration Menu**.
7. **Select - Cal. Type** → **Manual - Accept**.
8. **Select - Cal. Mode** → **Span** or **Zero** - Accept (depending on the option installed).

Note: When using the high pressure zero option, ensure **Zero Source** is set to **External**.

9. Adjust the regulator pressure until the flow meter on the vent line (**Calibration Port**) is between 0.5 and 1 slpm. This flow rate is you excess calibration gas.

Note: Do not exceed a pressure of 2 bars, this can damage the instrument and cause gas leakage.

Return to Normal Operation

10. **Select - Cal. Mode** → **Measure** - Accept. (To return to sample measure).
11. Remove the flow meter on the **Calibration Port** and connect a vent line.
12. Reconnect the instrument fittings and return to the original set-up.

The instrument is now in normal operation mode. When either zero or span calibration is initiated (depending on which option has been installed) the instrument will automatically open the valves to run a pressurised calibration.

5.8.2 Dual Pressurised Calibration Option

Set-Up of Dual Calibration Option

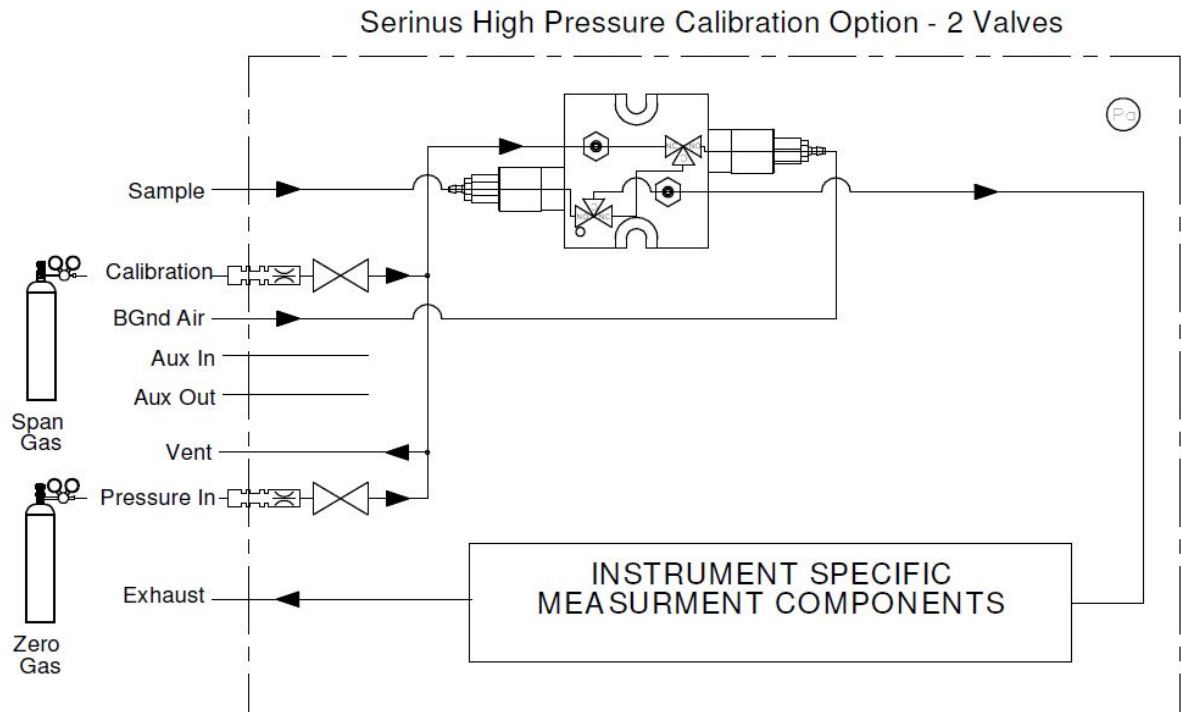

Figure 49 – Dual High Pressure Calibration Option

When using the dual pressurised calibration option, a high pressure zero cylinder should be connected to the **Pressure in Port** and a high pressure span cylinder connected to the **Calibration Port**.

Equipment Required

- Calibrated Flow Meter
- Gas Cylinder of Zero air
- Gas Cylinder of SO₂

Procedure

1. Ensure the gas cylinder is fitted with an appropriate gas regulator with a shut off valve.
2. Connect a ¼" line of stainless steel tubing between the appropriate gas cylinders and the instrument's **Pressure in Port** and **Calibration Port**.

Note: This connection may need to be retightened during this operation.

3. Open the cylinder main valve and adjust the regulator to 15 psig.
4. Open the regulator's shutoff valve and test for leaks:
 - a. Pressurise the line.
 - b. Close the cylinder main valve.

- c. If pressure drops by more than 2 PSI over five minutes, check the connections and retest.
- d. Open cylinder main valve.
5. Temporarily place a flow meter on the **Vent Port** (This port is now used as the high pressure calibration vent for both span and zero).
6. Open - **Main Menu → Calibration Menu**.
7. **Select - Cal. Type → Manual - Accept**.
8. **Select - Cal. Mode → Zero - Accept**.

Note: When using the high pressure zero option, ensure **Zero Source** is set to **External**.

9. Adjust the regulator pressure until the flow meter on the vent line (**Vent Port**) is between 0.5 and 1 slpm. This flow rate is you excess calibration gas.

Note: Do not exceed a pressure of two bars, this can damage the instrument and cause gas leakage.

10. **Select - Cal. Mode → Span - Accept**.
11. Adjust the regulator pressure until the flow meter on the vent line (**Vent Port**) is between 0.5 and 1 slpm. This flow rate is you excess calibration gas.

Note: Do not exceed a pressure of two bars, this can damage the instrument and cause gas leakage.

Return to Normal Operation

12. **Select - Cal. Mode → Measure - Accept**. (To return to sample measure).
13. Remove the flow meter on the **Vent Port** and connect a vent line.
14. Reconnect the instrument fittings and return to the original set-up.

The instrument is now in normal operation mode. When either zero or span calibration is initiated the instrument will automatically open the valves to run a pressurised calibration.

6. Service

6.1 Maintenance Tools

To perform general maintenance on the Serinus 51 the user may require the following equipment:

- Customizable Test Equipment Case PN: H070301
- Digital Multimeter & Leads (DMM) PN: E031081 & E031082
- Barometer PN: E031080
- Thermometer & Probe PN: E031078 & E031079
- Flow Meter (Select Range)
 - Range: 50 sccm to 5000 sccm PN: ZBI-200-220M
 - Range: 300 sccm to 30000 sccm PN: ZBI-200-220H
- Minifit Extraction Tool PN: T030001
- Orifice/Sintered Filter Extraction Tool PN: H010046
- Leak Test Jig PN: H050069
- Computer/Laptop and Connection Cable for Diagnostic Tests
- 1.5 mm Hex Key
- Assortment of 1/4" and 1/8" Tubing and Fittings.
- Zero Air Source
- Span Gas Source



Figure 50 – Minifit Extraction Tool – (PN: T030001)



Figure 51 – Orifice/Sintered Filter Removal Tool – (PN: H010046)

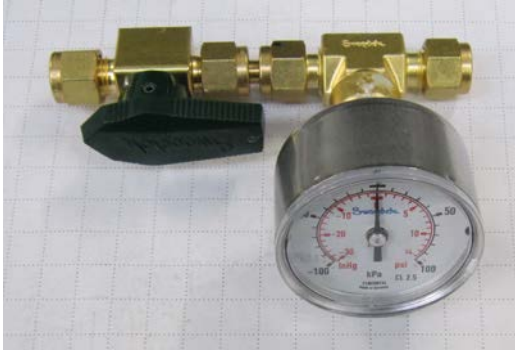

Figure 52 – Leak Test Jig – (PN: H050069)



Figure 53 – Air Monitoring Test Equipment Kit (AMTEK) – Customisable

6.2 Maintenance Schedule

The maintenance intervals are determined by compliance standards that differ in various regions. The following is recommended by Ecotech as a guide. Compliance with local regulatory or international standards is the responsibility of the user.

Table 6 – Maintenance Schedule

Interval *	Task Performed	Section
Nightly or Every 5 days	Perform precision check (Automated) Perform precision check (Manual) (This task is performed to ensure a high data capture rate)	5.5

Interval *	Task Performed	Section
Monthly	Perform precision check (pre-check) prior to commencing any service tasks or making any changes to the system as found in its current state. This task is necessary to validate any previously captured data.	5.5
	Check particulate filter, replace if full/dirty	6.3.1
	Perform a pressure check	6.3.10
	Refill water reservoir	
	Check sample inlet system for moisture or foreign materials. Clean if necessary	
	Check fan filter and clean if necessary	6.3.2
	Check event log	3.4.1
	Check date and time is correct	3.4.8
	Check instrument status light	3.3.1
	External vacuum pump check (vacuum source)	
	leak check	6.3.4
	Perform SO ₂ span calibration	5.4
	Perform precision check (post-check) once all service tasks have been completed. This task is necessary to establish a valid start point to begin capturing new data.	5.5
6 Monthly	Replace the PMT Desiccant Packs	6.3.5
	Perform multipoint precision check	5.6
	Perform a H ₂ S converter efficiency check	5.7
	Calibrate analog outputs (only if used)	3.4.24
	Check the zero air scrubbers, replace if saturated	6.3.6
	Check the UV lamp alignment, replace if necessary	6.3.8
Yearly	Replace DFU filter	6.3.3
	Replace sintered filter and orifice (only if necessary)	6.3.7 & 9.7
	Replace the SO ₂ selective scrubber	

* Suggested intervals for maintenance procedure are a guide only and may vary with sampling intensity and/or environmental conditions. Please refer to your local regulatory standard for your personalised maintenance schedule.

6.3 Maintenance Procedures

6.3.1 Particulate Filter Replacement

Contamination of the filter can result in degraded performance of the instrument, including slow response time, erroneous readings, temperature drift and various other problems.

1. Turn off the external pump and allow the instrument to return to ambient.
2. Slide open the lid of the instrument to access the particulate filter (located in front right hand corner).
3. Unscrew the filter cap (bright blue) by turning it counter-clockwise.
4. Remove the filter plunger from the casing, place finger on tubing connector and pull to the side (refer to Figure 54).

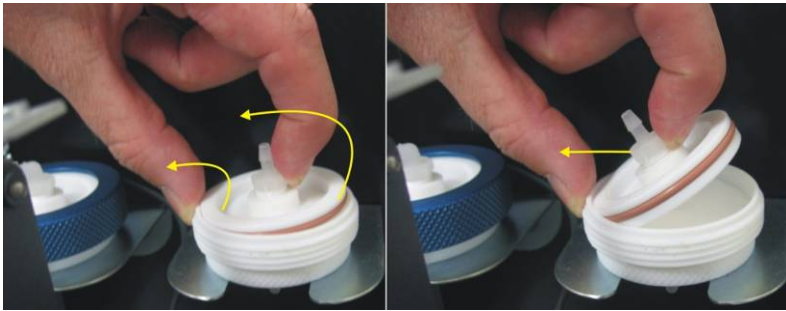

Figure 54 – Removing the Plunger

5. Remove the old filter paper, wipe down the plunger with a damp cloth and insert new filter.
6. Replace the plunger, screw on the filter cap.
7. Close the instrument and perform a leak check (refer to Section 6.3.4).

6.3.2 Clean Fan Filter

The fan filter is located on the rear of the instrument. If this filter becomes contaminated with dust and dirt it may affect the cooling capacity of the instrument.

1. Remove outer filter casing and filter (refer to Figure 55).
2. Clean filter with water and wring dry or shake vigorously.
3. Reinstall filter and filter casing.



Figure 55 – Removing the Fan Filter

6.3.3 DFU Replacement

Equipment Required

- 5/8" Spanner

Procedure

1. Turn off the external pump and allow the instrument to return to ambient.
2. Loosen the Kynar nuts from both ends of the DFU.
3. Remove and replace the DFU (refer to Figure 56 left hand side of the DFU in the image should connect to the fitting at the bottom of the zero air scrubber) and tighten the Kynar nuts.



Figure 56 – DFU Filter

6.3.4 Leak Check

Equipment Required

- Source of Vacuum (pump)
- Leak Test Jig (PN: H050069)
- Kynar ¼" Blocker Nuts
- Tubing and Assorted Fittings
- 5/8" Spanner
- 9/16" Spanner
- 7/16" Spanner

Procedure

Note: Ensure that the instrument has been running for at least one hour before this procedure is performed.

1. Disconnect all external tubing connected to the rear ports of the instrument.
2. Connect a leak check jig to the Exhaust Port of the instrument.
3. Connect a vacuum source to the shut off valve end of the leak test jig ensuring the shut off valve is in the open position.
4. Open - **Main Menu → Service Menu → Diagnostics Menu → Valve Menu.**
5. Disable - **Valve Sequencing → Disabled.**
6. Turn **Off** all the valves.
7. Block the **BGnd Air Port.**
8. Use tubing to connect the **Sample Port** and **Aux In Port**

9. Allow the instrument time to evacuate the pneumatic system (the time required will depend on the vacuum source used).
10. Close the shut off valve and record the vacuum. Wait for three minutes and observe the gauge on the leak check jig. It should not drop more than 5 kpa (37.5 torr). If the leak check passed skip to step 13.
11. Inspect the instrument's plumbing looking for obvious damage. Check the condition of fittings, particulate filter housing plus the O-rings both in the filter assembly and in the reaction cell assembly.
12. If the leak is still present divide up the pneumatic system into discrete sections to locate the leak (refer to Section 9.5). When the location of the leak has been determined repair and then rerun the leak check procedure.
13. Remove the tubing linking the **Sample Port** and **Aux In Port** and allow the instrument to return to ambient.
14. Remove the blocker on the **BGnd Air Port**.
15. Inspect the internal tubing to ensuring that the tubing is cleanly connected to the fittings and that the internal Teflon lining has not been kinked or crumpled.
16. Remove the leak check jig.
17. Enable - **Valve Sequencing** → **Enabled**.

6.3.5 Replacing the PMT Desiccant Pack

The PMT housing contains two desiccant packs to prevent condensation on the PMT cold block. If the desiccant expires it will result in premature cooler failure. It is recommended that the desiccant bags be changed at least annually. If moisture is detected inside the housing or the desiccant packs are saturated the interval should be reduced. To change the desiccant packs follow the instructions below:



CAUTION

Because the PMT is extremely sensitive to light, it is essential that before opening the PMT assembly to make sure that the instrument is switched off.

In addition, even when the instrument is switched off it is very important to cover the PMT at all times so that no direct light reaches its window.

Equipment Required

- Phillips Head Screwdriver
- New Desiccant Packs
- Tweezers

Procedure

1. Turn the instrument off and disconnect the power. Wait 15 min for the cold block to warm up.
2. Using an offset Phillips head screwdriver, remove the desiccant pack access cap from the PMT housing (Refer to Figure 57).

3. Remove the old desiccant packs and replace with new ones. Do not attempt to dry and reuse the old packs.
4. Inspect the inside of the PMT housing (by touch or with an inspection mirror) to check for moisture inside the housing. If moisture is detected inside the housing or the desiccant packs are saturated, the desiccant packs should be replaced more frequently.
5. Reinstall the desiccant cap by gently twisting and pressing the cap back into the PMT housing. It may help to apply a small amount of lubricant to the O-ring on the desiccant cap. Secure with two screws.
6. Reconnect power and restart the instrument.

Note: Removal of the desiccant access cap may be easier if the Rx cell/PMT housing is removed from the instrument.

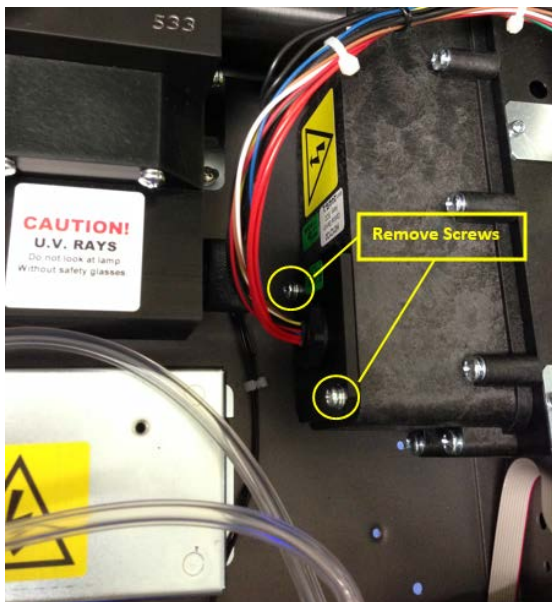

Figure 57 – Remove Desiccant Access Cap



CAUTION

Do not attempt to use the fastening screws to push the desiccant cap in place in the PMT housing. This will damage the O-ring.

6.3.6 Replace Zero Air Scrubber

Equipment Required

- Flat Screwdriver

Procedure

1. Turn off the external pump and allow the instrument to return to ambient.
2. Open the lid of the instrument.

3. Remove the tubing from the barb fitting on top of the scrubber (refer to Label 1 in Figure 58).
4. Remove the DFU from the fitting below the scrubber by pulling it out (refer to Label 2 in Figure 58).
5. Now the scrubber holder can be opened with a screwdriver (refer to Label 3 in Figure 58).

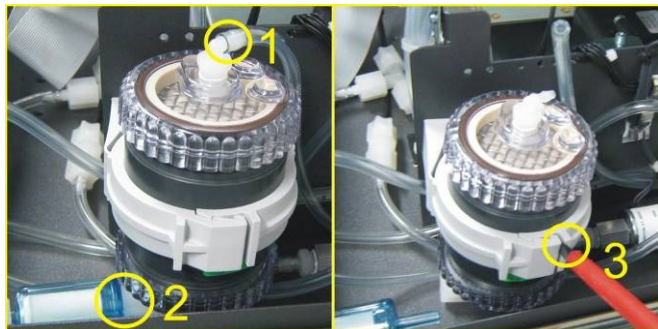

Figure 58 – Zero Scrubber Removal

6. The zero scrubber can now be replaced with a new scrubber and all fittings and tubing replaced.
7. Perform a leak check (refer to Section 6.3.4).
8. Perform a zero and span calibration (refer to Section 5.3 and Section 5.4).

Table 7 – Zero air scrubber replacement frequency

Average SO ₂ Concentration	Charcoal Replacement Frequency
0 to 30 ppb	12 Months
30 to 100 ppb	6 Months
> 100 ppb	1 Month

6.3.7 Orifice Replacement

Equipment Required

- Orifice removal tool (PN: H010046)
- Teflon Tape
- 5/8" Spanner

Procedure

1. Turn off the external pump and allow the instrument to return to ambient.
2. Turn off the instrument and disconnect the pump.
3. Disconnect the tubing from the T-piece on top of the reaction cell (refer to Figure 59).

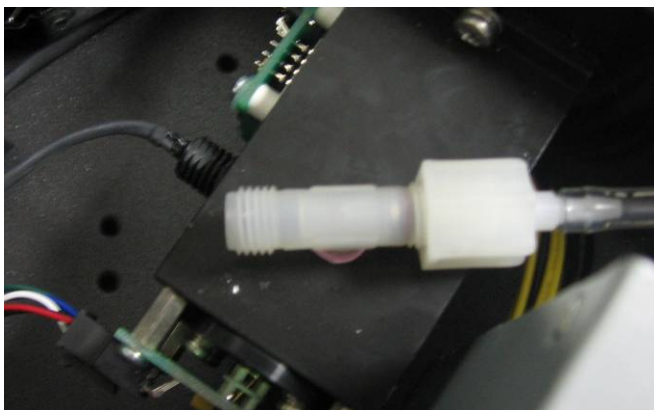

Figure 59 – Reaction Cell T-Piece

4. Unscrew the T-piece from the cell (anti-clockwise).
5. Once the T-piece has been removed use the orifice/filter removal tool to remove the orifice.
6. The orifices may be exchanged with new ones or cleaned as needed.
7. Replace the orifice(s) in the correct part of the T-piece (#12 in the bottom of the T-piece and #20 in the side).
8. Apply Teflon tape to the thread of the T-piece and replace as before.
9. Perform a leak test (refer to Section 6.3.4).
10. Perform zero and span calibrations (refer to Section 5.3 and Section 5.4).

6.3.8 UV Lamp Alignment

Proper operation of the UV lamp is essential to the Serinus 50. The UV lamp should be checked every six months to ensure it is operating within acceptable parameters and may require realignment to maintain sufficient UV light for instrument operation. The UV lamp will need to be adjusted only when the **Ref. Gain Pot** goes above 100 or below 5. Following are procedures to check align and replace the UV lamp assembly.



CAUTION

Ecotech recommends the use of UV protective glasses when adjusting the UV lamp.



CAUTION

The Lamp Driver PCA can generate in excess of 1000 volts. Exercise extreme care when working in the vicinity of the Lamp Driver.



CAUTION

If the UV lamp is adjusted, the instrument will require recalibration.

Equipment Required

- Oscilloscope
- UV Protective Glasses

Procedure

1. Turn the instrument on and allow the UV lamp to warm-up and stabilise (about 30 minutes).
2. Connect an oscilloscope to TP19 (SO2 REF2) and TP1 (AGND) on top of the main control board. Adjust the scope for 0.5 V/division and 20 msec/division.
3. Loosen the collets (do not remove) at each end of the lamp (refer to Figure 60).



Figure 60 – Collets of the UV Lamp

4. Physically adjust the UV lamp (rotate and move left and right) until the maximum peak voltage on the oscilloscope is obtained. The minimum usable output from the lamp is approximately 0.8 volts amplitude (peak to peak). If the UV lamp output is below 1.0 volts, replacement should be considered.
5. Tighten the UV lamp collets and verify the UV lamp has remained at its previously adjusted position.
6. Reset the instrument and allow it to run a start-up sequence.
7. Perform zero and span calibrations (refer to Section 5.3 and Section 5.4).

6.3.9 Clean Pneumatics

The calibration valve manifold and aux valve manifold will require disassembling and cleaning. Ideally the valves and the manifold should be cleaned in a sonic bath with lab detergent and water (except for the Aux valves). Once clean, rinse with distilled water and dry before reassembling (for calibration valve manifold refer to Section 9.12 and Section 9.13 and for aux valve manifold refer to Section 9.11). A leak test should be performed once the instrument is ready for operation (refer to Section 6.3.4).

If the tubing shows signs of significant contamination, it should be replaced with new tubing.

6.3.10 Pressure Sensor Check

Pressure checks are needed to ensure that the pressure sensor is accurately measuring pressure inside the instrument.

During normal operation ensure that the **Pressure & Flow Menu** indicate the following parameters. Ambient should display the current ambient pressure at site. Cell should indicate current cell pressure. Depending on the pump condition and location, a value of between 30 to 40 torr below ambient is recommended.

Equipment Required

- Barometer
- Digital Multimeter (DMM)

Procedure

1. Open - **Main Menu** → **Analyser State Menu** → **Pressure & Flow Menu**.
2. Turn off the vacuum pump and allow the instrument to return to ambient.
3. Disconnect all external tubing connected to the rear ports of the instrument.
4. After two-five minutes observe the pressure readings: ambient and cell. Ensure that they are reading the same ± 3 torr (± 0.4 kPa).
5. If the readings are outside this level, perform a pressure calibration (refer to Section 5.2.2).

If the calibration fails the instrument may have a hardware fault. The cell pressure PCA has test points. To determine if the pressure sensor is faulty simply measure the voltage on the test points shown the photos. The voltage measured across the test point is proportional to the pressure measured by the sensor so if the sensor is exposed to ambient pressure at sea level the voltage will be around 4 volts but if the sensor is under vacuum the voltage will be low (e.g. 0.5 volts). If the test point measures zero or negative voltage the assembly is most likely faulty and will need to be replaced.

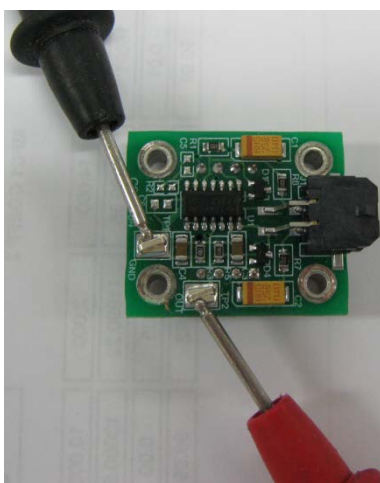

Figure 61 – Test Point Location

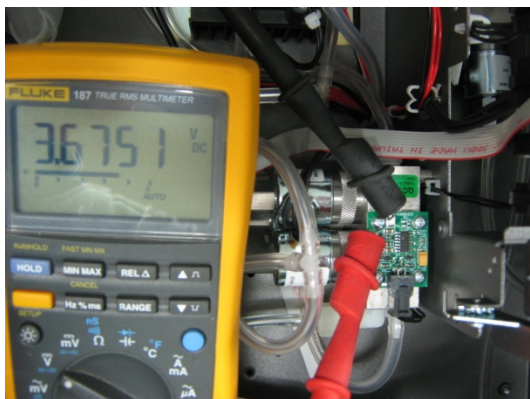

Figure 62 – Typical Test Point Reading of Cell Pressure Sensor

6.4 Bootloader

The Serinus Bootloader is the initial set of operations that the instruments' microprocessor performs when first powered up (similar to the BIOS found in a personal computer). This occurs every time the instrument is powered up or during instrument resets. Once the instrument boots up, it will automatically load the instruments' firmware. A service technician may need to enter the Bootloader to perform advanced microprocessor functions as described below.

To enter the Bootloader turn off the power to the instrument. Press and hold the plus key while turning the power on. Hold the Plus key until the following screen appears.

** Ecotech Serinus Analyser **
V3.1 Bootloader
Press '1' to enter Bootloader

If the instrument displays the normal start up screen, the power will need to be toggled and another attempt will need to be made to enter the Bootloader. Once successful, press 1 to enter the **Bootloader Menu**.

6.4.1 Display Help Screen

Once in the Bootloader screen it is possible to redisplay the help screen by pressing 1 on the keypad.

6.4.2 Communications Port Test

This test is very useful for fault finding communication issues. It allows a communication test to be carried out independent to any user settings or firmware revisions.

This command forces the following communication ports to output a string of characters: Serial Port RS232 #1, USB rear and Ethernet Port. The default baud rate is 38400 for the RS232 Serial Port. To initiate the test press the number 2 key from the Bootloader screen.

6.4.3 Updating Firmware

It is important for optimal performance of the instrument that the latest firmware is loaded. The latest firmware can be obtained by visiting Ecotech's website:

<http://www.ecotech.com/downloads/firmware>

Or by emailing Ecotech at service@ecotech.com **or** support@ecotech.com

To update the firmware from a USB memory stick, use the following procedure:

USB Memory Stick Update

1. Turn the instrument off.
2. Place the USB memory stick with the new firmware (ensure that firmware is placed in a folder called FIRMWARE) in the front panel USB Port.
3. Enter the Bootloader (refer to Section 6.4).
4. Select option 3 (upgrade from USB memory stick), press 3 on the keypad.
5. Wait until the upgrade has completed.
6. Press 9 on the keypad to start the instrument with new firmware.

6.4.4 Erase All Settings

This command is only required if the instrument's firmware has become unstable due to corrupted settings. To execute this command enter the **Bootloader Menu** (refer to Section 6.4) and press 4 on the keypad.

6.4.5 Start Analyser

The start analyser command will simply initiate a firmware load by pressing 9 on the keypad from the **Bootloader Menu**. It is generally used after a firmware upgrade.

This page is intentionally blank.

7. Troubleshooting

Before troubleshooting any specific issues, Ecotech recommends ensuring the instrument has successfully completed its start-up routine and resolving all issues listed in the instrument status menu (refer to Section 3.4.4).

Table 8 – Common Errors and Troubleshooting

Error Message/Problem	Cause	Solution
Flow fault	Multiple possibilities	Refer to Section 7.1.
	Pump failed	Replace the external pump.
	Blocked filter or orifice	Replace sintered filter and orifice.
	Pressurised reaction cell	Ensure sample and zero inlets are maintained at ambient pressure. Ensure that the vacuum pump is connected correctly.
	Pressure sensors	Check pressure sensor voltages displayed in pressure calibration menu both the ambient and cell voltage should equal 4 volts ± 0.5 (at sea level). If not replace pressure sensor assembly. Perform a pressure calibration. Refer to section 5.2.
Noisy/unstable readings	Multiple possibilities	Refer to Section 7.2.
	Calibration system error	<ul style="list-style-type: none"> ▪ Ensure calibration system is functioning correctly and is leak free. ▪ Ensure sufficient gas is available for instrument and an adequate vent is available for excess gas.
	Leaks	A leak in the analyser or calibration system dilutes the sample stream and causes low span readings and noise.
	Lamp not correctly positioned	Adjust the UV lamp. If you are unable to obtain an acceptable reading, replace the lamp (refer to Section 6.3.8).
	TE cooler or Reaction cell heater	A failed temperature control allows the instrument to drift with ambient temperature. Verify that the cell temperature is 50 ± 3 °C (refer to Section 7.4 below) and that the TE cooler is 13 ± 2 °C.
	Hardware fault	Faulty optical bench component.

	Gain too high	<ul style="list-style-type: none"> ▪ Leak check (repair any leaks) UV lamp filter in reaction cell deteriorated – replace. ▪ PMT voltage too low less than 700V. ▪ UV lamp requires replacing (refer to Section 6.3.8).
	PMT temperature too high (>15°C)	<ul style="list-style-type: none"> ▪ Check optical bench heat sink fan is operating. ▪ Check chassis temperature is <48°C. ▪ Check PMT cooler is operational and correct amount of thermal paste is applied.
	Reference gain digital potentiometer out of normal range	<ul style="list-style-type: none"> ▪ Check value in menu (refer to Section 3.4.14). ▪ If out of normal range, replace UV lamp and/or UV lamp filter.
Electronic zero adjust	Faulty zero air or contaminated cell/pneumatics	Refer to Section 7.3.
Cell temperature failure	Faulty heater or temperature sensor	Refer to Section 7.4.
Analyser resetting	Multiple possibilities	<ul style="list-style-type: none"> ▪ Check that the instrument is not overheating. ▪ Possibly a faulty power supply. ▪ Electrical issue component shorted to ground. ▪ Corrupted firmware's perform and 'erase all settings' in the Boot loader Menu and reload or upgrade firmware.
Voltage supply failure	Power supply has failed	Replace power supply.
No display	AC power	Verify that the mains power cable is connected and the rear power supply fan is operating.
	Contrast misadjusted	<p>Adjust the display contrast by pressing two keys on the front panel:</p> <ul style="list-style-type: none"> ▪ Press Up arrow (▲) for darker contrast. ▪ Press Down arrow (▼) for lighter contrast. <p>Please note you must be in the home screen.</p>

	DC power	Verify that the power supply is providing the correct DC voltages: +12V (TP34), -12V (TP23) & +5V (TP39) DC.
	Display	Check the interface cable between the display and the main controller PCA (J16)
	Bad display or Main controller PCA	<ul style="list-style-type: none"> ▪ Replace the front panel display. ▪ Replace the main controller PCA. ▪ Bad cables are unlikely, but if you suspect it, perform a pin-for-pin continuity test using an ohmmeter.
Sample pressure too high or low	Loss of pressure calibration	<ul style="list-style-type: none"> ▪ Perform a pressure calibration. Refer to Section 5.2 ▪ Ensure particulate filter has been recently changed. Ensure tubing is not kinked or blocked. ▪ Ensure vacuum pump is correctly installed and operating.
Sample flow not equal to 0.70 slpm during H2S and 1.4 slpm during the SO2 cycle	Multiple possibilities	<ul style="list-style-type: none"> ▪ Check/replace sample filter. ▪ Check pump. ▪ Check valves. ▪ Check/replace sintered filter. ▪ Re-calibrate pressure sensors.
Unstable flow or pressure readings	Faulty pressure sensors	<p>Check pressure transducer calibration. Check calibration valve assembly is functioning and not blocked. If unable to diagnose problem, check voltage across TP1 and TP2 of pressure PCA ensure it is about 3.5 volts +/- 0.3 volts.</p> <p>If unable to diagnose problem it may be a noisy A/D converter, replace main PCB</p>
Low span	Leaks	A leak in the analyser or calibration system dilutes the sample stream and causes low span readings and noise.
	Span calibration out	Adjust the span using the calibration procedure (refer to Section 5.4).
	Faulty lamp	Replace UV lamp (refer to Section 6.3.8).
Low span	Damaged Hydrocarbon Kicker	Inspect the assembly for signs of tampering.

Higher than expected H2S reading	SO2 scrubber	Ensure the water reservoir is not empty.
Lower than expected H2S reading	H2S converter	Preform converter efficiency procedure (refer to Section 5.7).
No response to span gas	Leaks/blockages	Leak or blockages in tubes or valves. Perform leak check and flow check and repair any leaks/blockages.
	Faulty calibration source	Ensure calibration gas is plumbed correctly, is not contaminated, has no leaks and is a certified reference gas.
Zero drift	Poor temperature control	Ensure instrument is operated in a temperature controlled environment with the lid on.
	Charcoal contaminated	Replace the charcoal in the scrubber feeding the background port.
	Faulty zero air	Ensure zero air sources have been maintained.
	Leak	Perform leak test (refer to Section 6.3.4).
Negative response	Internal scrubber	Charcoal scrubber contaminated. Replace charcoal and preform a leak check (refer to section 6.3.4).
Input pot limited to 0 or 255	Damaged lamp	Check that lamp current is 35mA. If not 35mA replace Lamp driver PCA. If pot still 255, replace UV lamp.

7.1 Flow Fault

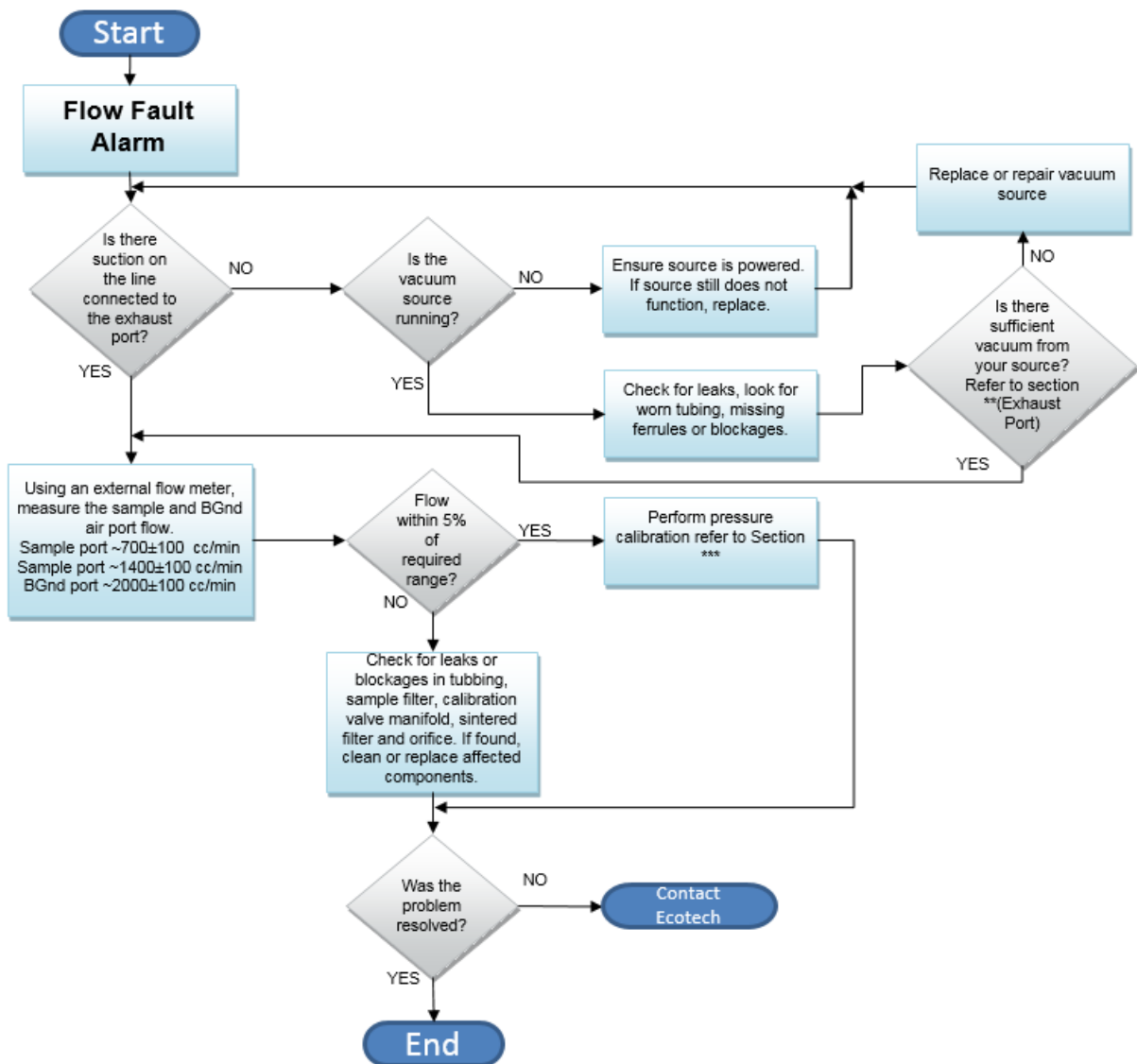

Figure 63 – Flow Fault Diagnostic Procedure

** Section 2.3.1

*** Section 5.2

7.2 Noisy/Unstable Readings

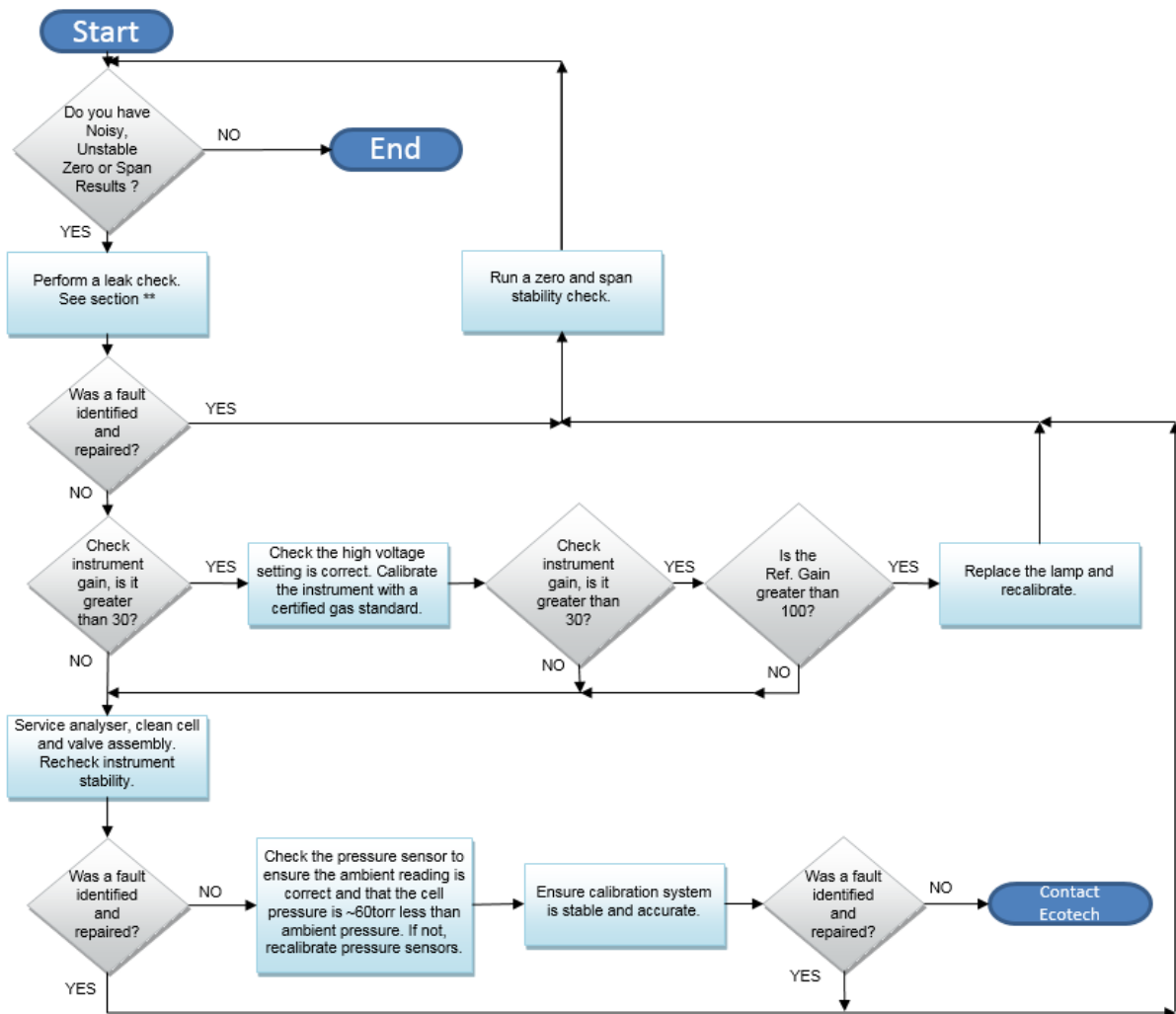

Figure 64 – Noisy or Unstable Zero or Span Results

** Section 6.3.4

7.3 Electronic Zero Adjust

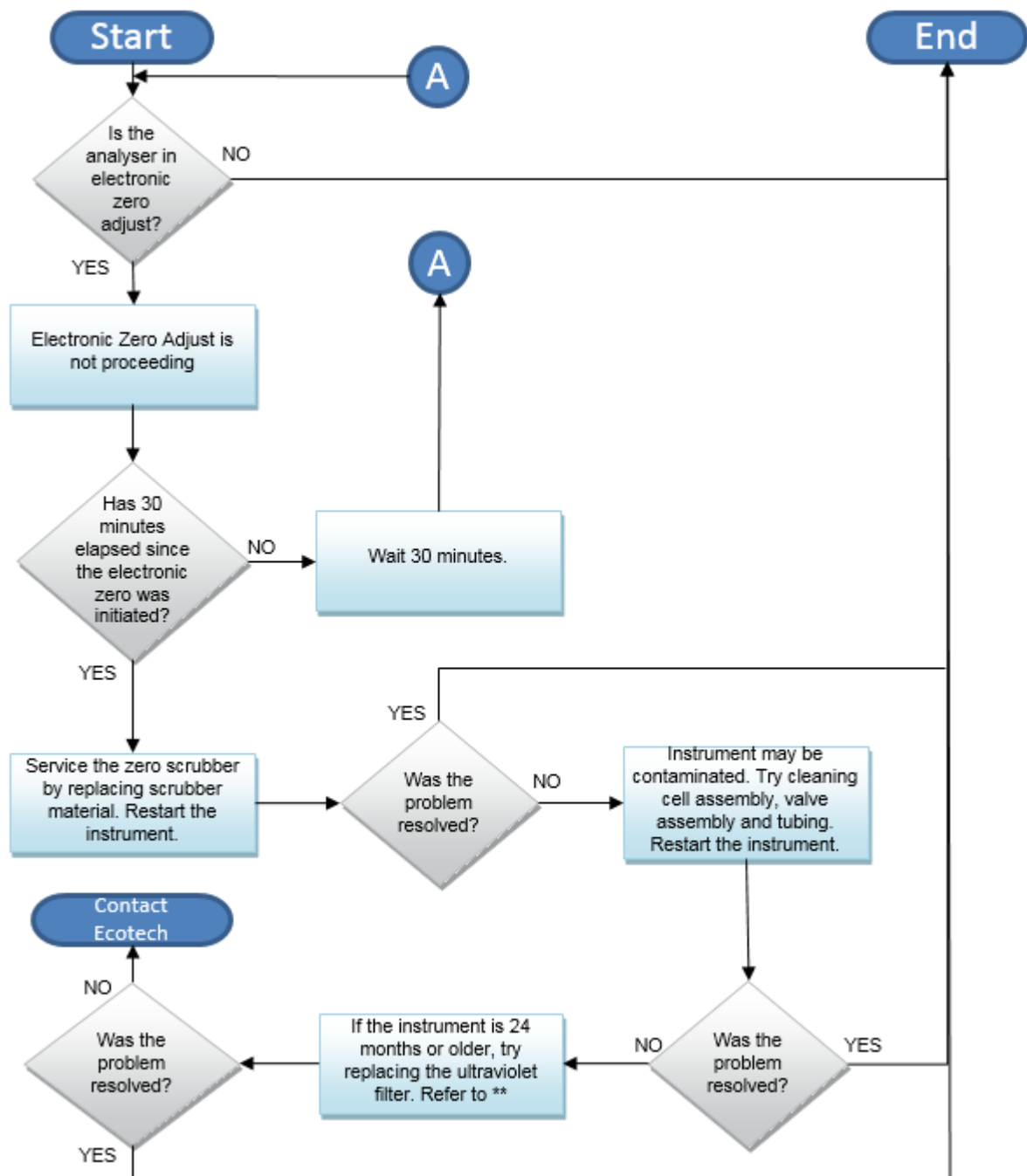

Figure 65 – Troubleshooting, Electronic Zero Adjust

** Table 12 – Spare Parts List Serinus 51

7.4 SO₂ Reaction Cell Temperature Failure

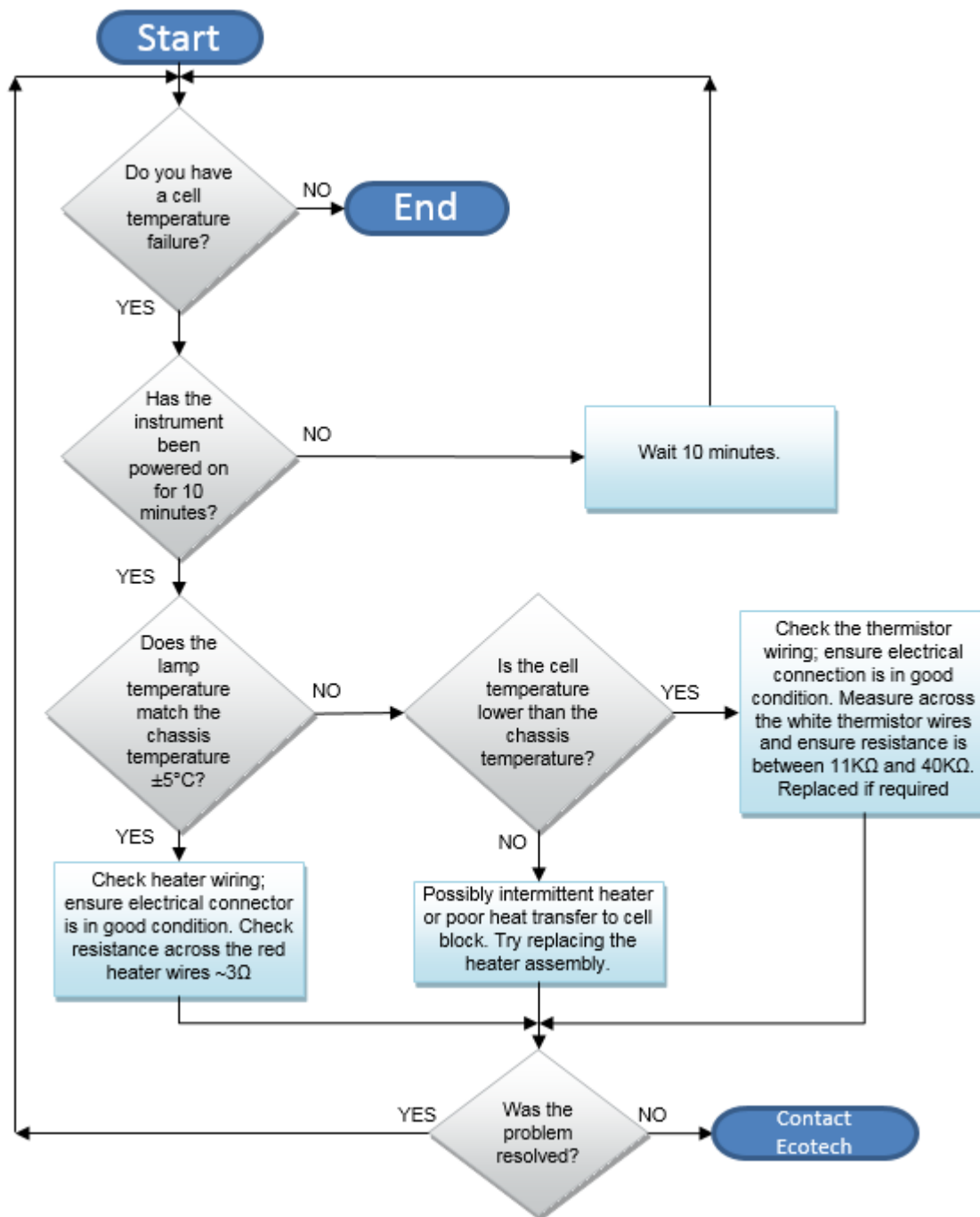

Figure 66 – Troubleshooting, SO₂ Reaction Cell Temperature Failure

7.5 USB Memory Stick Failure

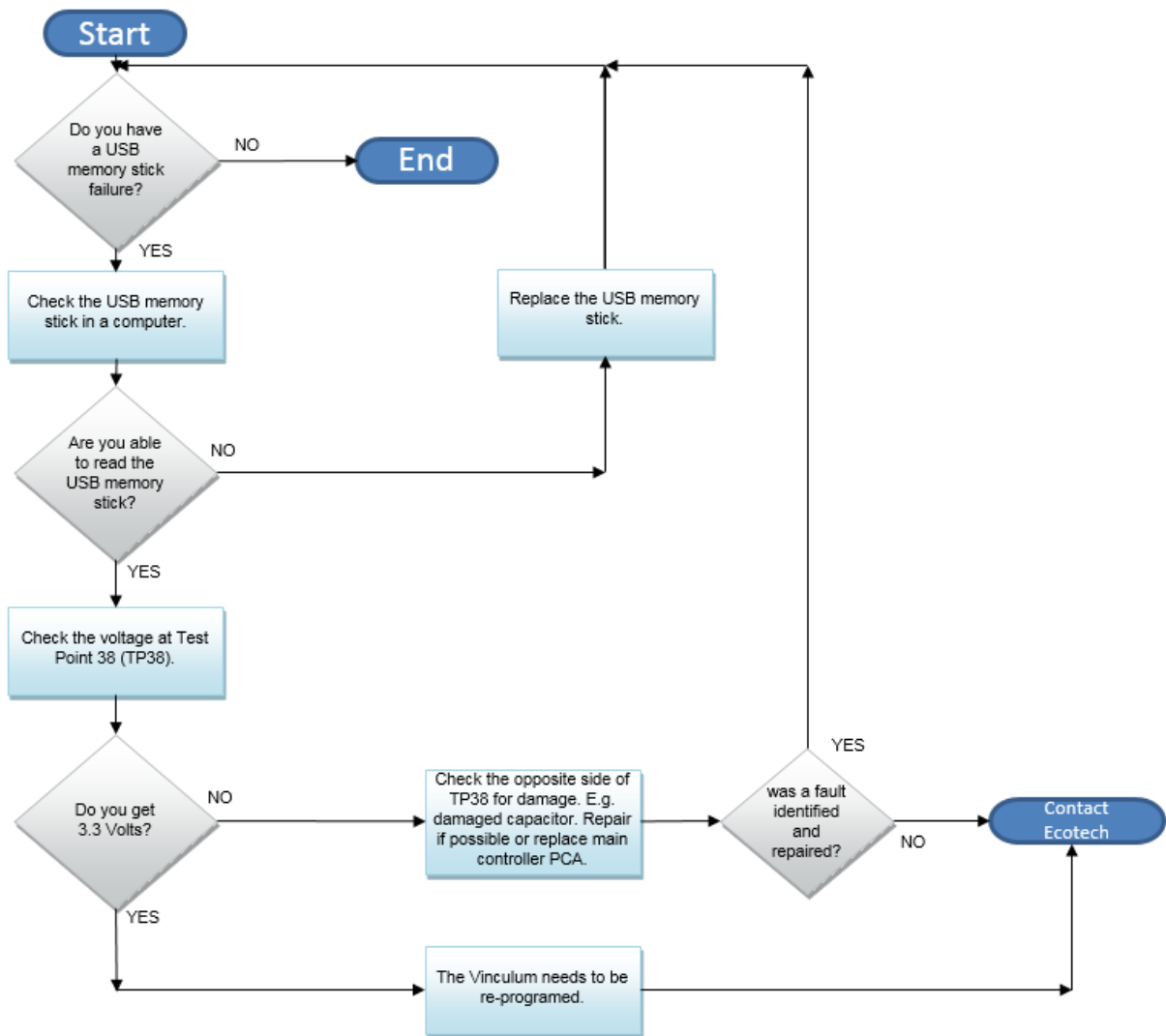

Figure 67 – USB Memory Stick Failure

7.6 Ecotech Service Support Files

Regular backup of the settings, parameters and data on the instruments USB memory stick is recommended.

In the event of a fault that requires Ecotech technical support, please make copies of the following files and email to: support@ecotech.com

Equipment Required

- PC/Laptop

Procedure

State the ID number, variant, board revision and firmware version of the instrument with a brief description of the problem. Take a copy of the current configuration if possible and a save of the parameters.

1. Open - **Main Menu** → **Analyser State Menu**.
2. **Variant** - (take note).
3. **Ecotech ID** - (take note).
4. **Board Revision** - (take note).
5. **Firmware Ver.** - (take note).
6. Open - **Main Menu** → **Service Menu**.
7. Save - **Save Configuration** - (CONFIG**.CFG) - Accept.

Note: CONFIG99.CFG is the “Factory Backup” file, this is the configuration of the instrument as it left the factory. It is recommended that this file is kept unchanged but can be used as a reference backup point.

** Can be any number from 0 – 98.

8. Save - **Save Parameter List** - (PARAM**.TXT) - Accept.
9. Eject - **Safely Remove USB Stick** - (Follow instructions).

Note: PARAM99.TXT is the “Factory Backup” file, This is a snap shot of the parameters while it was under test in the factory just prior to release. It is recommended that this file is kept unchanged but can be viewed for reference.

** Can be any number from 0 – 98.

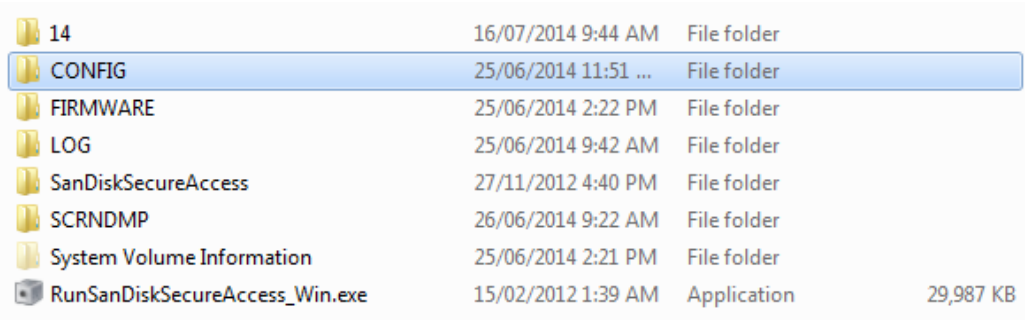

14	16/07/2014 9:44 AM	File folder	
CONFIG	25/06/2014 11:51 ...	File folder	
FIRMWARE	25/06/2014 2:22 PM	File folder	
LOG	25/06/2014 9:42 AM	File folder	
SanDiskSecureAccess	27/11/2012 4:40 PM	File folder	
SCRNDMP	26/06/2014 9:22 AM	File folder	
System Volume Information	25/06/2014 2:21 PM	File folder	
RunSanDiskSecureAccess_Win.exe	15/02/2012 1:39 AM	Application	29,987 KB

Figure 68 – USB Memory Stick File Structure

10. Insert the USB memory stick into your PC/Laptop computer and access the files.
11. Best practice is to email all the on the USB memory stick but if it's too large just send:
12. The CONFIG**.CFG and PARAM**.TXT files that are saved in the CONFIG folder.
13. The LOG files (Event Log text files) and data files (14=Year, Sub folder=month).
14. Safely Eject the USB from the PC/Laptop and return to the instrument.

This page is intentionally blank.

8. Optional Extras

8.1 Dual Sample Filter (PN E020100)

The dual filter is designed with two sample filters plumbed in parallel with a split line. This formation allows sample flow not to be affected, yet reduces the loading on each filter and therefore the frequency with which they will need to be changed.

The dual filter option is shown in the pneumatic diagram (dashed line) and requires no operational changes to the instrument.

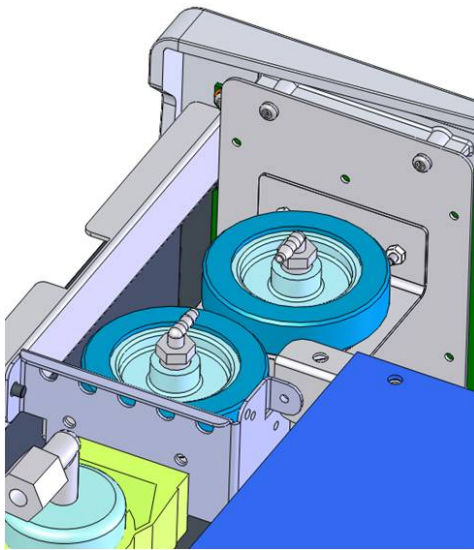

Figure 69 – Dual Filter Option Installed

8.2 Rack Mount Kit (PN E020116)

The rack mount kit is necessary for installing the Serinus into a 19" rack (the Serinus is 4RU in height).

Included Items

1	Rack Slide Set	H010112
4	Rack Mount Adaptors	H010133
2	Rack Mount Ears	H010134
4	SpacersHAR-8700	
8	M6 x 20 Button Head Screws	
16	M6 Washers	
8	M6 Nyloc Nuts	
18	M4 x 10 Button Head Screws	
8	M4 Washers	
8	M4 Nyloc Nuts	
8	M6 Cage Nuts	

Installing the Instrument

1. Remove the rubber feet from the instrument (if attached).
2. Separate the slide rail assembly by pressing the black plastic clips in the slide rails to remove the inner section of the rail (refer to Figure 70).

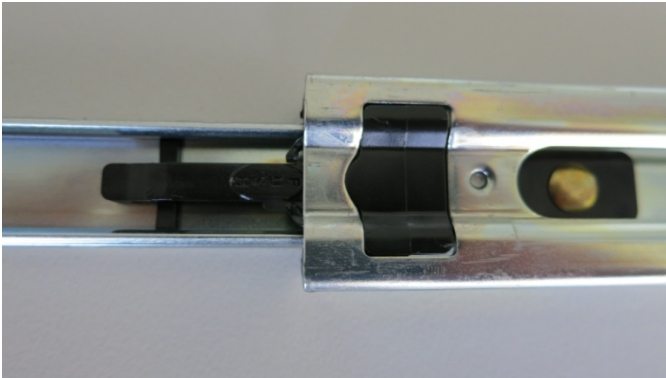

Figure 70 – Separate Rack Slides

3. Attach the inner slide rails to each side of the instrument using M4 x 10 button screws; three on each side (refer to Figure 71).



Figure 71 – Assemble Inner Slide on Chassis

4. Install rack mount ears on the front of the instrument using two M4 x 10 screws on each side (refer to Figure 72).



Figure 72 – Rack Mount Ears Fitted to Instrument

5. Attach the rack mount adaptors to the ends of the outer slide rails using M4 x 10 button screws, washers and locknuts. Do not fully tighten at this stage as minor adjustments will be required to suit the length of the rack (refer to Figure 73).



Figure 73 – Attach Rack Mount Adaptors to Outer Slides

6. Test fit the rack slide into your rack to determine the spacing of the rack mount adaptors.



Figure 74 – Test Fit the Rack Slide Assembly into your Rack

7. Install the two assembled outer slide rails onto the left and right side of the rack securely with M6 bolts; washer and locknuts/cage nuts (refer to Figure 75).

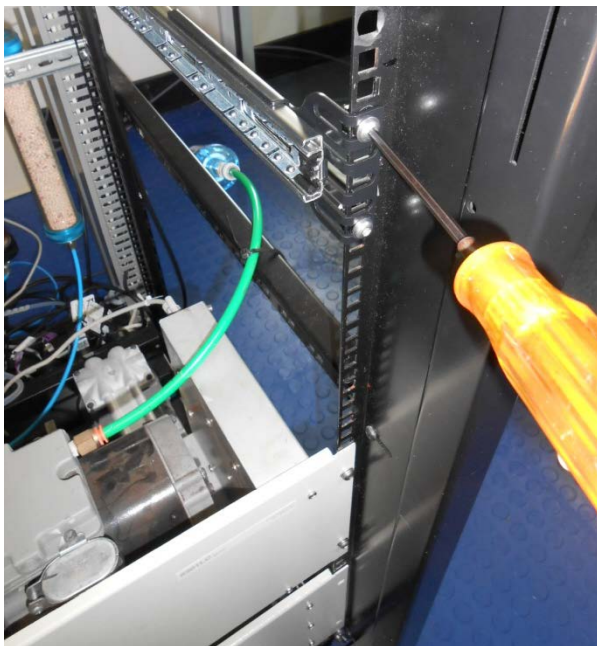

Figure 75 – Attach Slides to Front of Rack

8. Now carefully insert the instrument into the rack by fitting the instrument slides into the mounted rails. Ensuring that the rack slide locks engage on each side (you will hear a click from both sides).



CAUTION

When installing this instrument ensure that appropriate lifting equipment and procedures are followed. It is recommended that two people lift the instrument into the rack due to the weight, unless proper lifting equipment is available.

Note: Ensure both sides of the inner slide are attached to the outer slides before pushing into the rack fully.

9. Push the instrument into the rack. Adjust and tighten the screws as required to achieve a smooth and secure slide.

To Remove the Instrument

1. To remove the instrument first pull instrument forward of rack giving access to the slides.
2. Find the rack slide lock labelled **Push** and push it in whilst sliding the instrument out of the rack, complete this for both sides while carefully removing instrument.

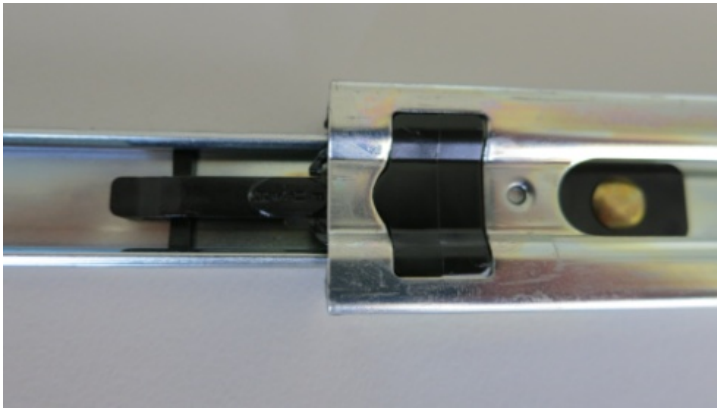

Figure 76 – Slide Clips

8.3 High Pressure Zero/Span Valves

High pressure span calibration valve (factory installed) PN E020108

High pressure zero calibration valve (factory installed) PN E020109

Note: Before using a high pressure span or zero as a source calibrating the instrument, please check with your local regulatory requirements.

Please refer to Section 5.8 for operation of this installed option: High Pressure Zero/Span Valves.

This page is intentionally blank.

9. Parts List and Schematics

9.1 Serinus Accessories Kit

This kit contains assorted fittings, tubing and an orifice removal tool which are useful when working on the instruments internal pneumatics. This is usually purchased with the instrument.

Table 9 – Serinus Accessories Kit H010136

Serinus Accessories Kit:	Part Numbers
Fitting, KYNAR UNIOUN TEE	F030007
Fitting KYNAR Union	F030008
Adapter, 1/4" FITTING TO 1/8"	H010007
Adapter, 1/4" TUBE TO 1/8" BARB	H010008
Orifice Extraction Tool	H010046
TUBING, TYGON 1/4 x 1/8 CLEAR (3 FEET)	T010011
TUBING, 1/4" OD, 1/8" ID BLACK (3 FEET)	T010021

9.2 Maintenance Kit

This maintenance kit is required when performing annual maintenance on the instrument. Depending on the environment that the instrument is operating, this maintenance may need to be carried out more often than yearly.

Table 10 – Serinus 51 Maintenance Kit - E020205

Serinus 51 Maintenance Kit: E020205	Part Number
SILICONE HEATSINK COMPOUND	C050013
DESICCANT 5 GRAM PACK	C050014
FILTER DFU 23 MICRON DIF-BN70	F010005
FILTER SINTERED	H010047-01
SCRUBBER SO2 SELECTIVE	H040011-01
WASHER SHOULDER, NYLON M3 x 6	F050040
WASHER NEO, .174x .38x.016	F050041
O-RING, BS115,	O010004
O-RING 0.364ID X 0.070W	O010010
O-RING, 5/32ID X 1/16W, BS007,	O010013
O-RING 1 11/16ID X 3/32W VITON	O010014
O-RING 1/4ID X 1/16W, VITON	O010015
O-RING 13/16ID X 1/16W, VITON	O010016

Serinus 51 Maintenance Kit: E020205	Part Number
O-RING 1 5/8 X 1/16, VITON	O010017
O-RING 5 3/4ID X 3/32W, VITON	O010018
O-RING 0.208ID X 0.07W, VITON	O010021
O-RING 1.739ID X 0.07W, VITON	O010022
O-RING BS015, VITON	O010023
O-RING 7/8ID X 1/16W, VITON	O010026
O-RING 0.987ID X 0.103W,	O010027
O-RING 1.364ID X 0.070W	O010028
O-RING 0.799ID X 0.103W	O010029
O-RING 1.862ID X 0.103W,	O010030
O-RING 5/16ID X 1/2OD X 3/32W,	O010031
O-RING, BS032, VITON	O010042
O-RING, BS038, VITON	ORI-1019
Ecotech Tygon Tubing,	T010011

9.3 Consumables

Parts shown as consumables below will require replacement over the course of the instrument’s lifespan.

Table 11 – Serinus 51 Consumables

Consumable	Part Number
Filter paper Teflon 47 mm pack of 50	F010006-01
DFU	F010005
Activated Charcoal, 1kg	ECO-1035
Orifice – Sample #12	H010043-11
Orifice – Sample #20	H010043-19
Orifice – Sample #8	H010043-06
UV Lamp Assembly	C020076
External Pump Repair Kit (suite 607 pump)	P031001
SO ₂ Selective Scrubber	H040011-01
Desiccant 5g Pack	C050014
H ₂ S Converter	H011105-51
Ecotech Tygon Tubing, 25ft Length	T010011-01

***Warranty Disclaimer:** The product is subject to a warranty on parts and labour from date of shipment (the warranty period). The warranty period commences when the product is shipped from the factory. **Lamps, fuses, batteries and consumable items are not covered by this warranty.**

Subject to use refers to variable ambient conditions, toxic gases, dirt, extremes of temperature and moisture ingress may shorten the lifespan of components.

9.4 Instrument Parts List

List of Serinus 51 components and part numbers for reference.

Table 12 – Spare Parts List Serinus 51

Part Description	Part Number
Serinus 51 User Manual	M010040
Main Controller PCA	E020230-01
Lamp Driver PCA	C010006-01
Reference Detector PCA	C010008
Pressure Sensor PCA	C010004
Pressure Sensor Gasket	H010037
Keypad PCA	C010003-01
LCD and Interface PCA	C010010-01
Power Supply, Serinus, Autoranging	P010013
USB Memory Stick	H030021
Orifice – Humidifier #8	H010043-06
Orifice – Sample #12	H010043-11
Orifice – H2S Bypass #12	H010043-11
Orifice – Kicker #20	H010043-19
DFU	F010005
Sintered Filter With O-ring Groove	H010047-01
Desiccant 5g Pack	C050014
Zero Air Scrubber (Charcoal)	H010038
SO ₂ Selective Scrubber	H040011-01
Sample Filter Assembly	H010020
Calibration Valve Manifold Assembly	H010013-01
Valve – 3 Way, 12VDC (For Calibration Valve Manifold)	H010042
Aux Valve Manifold Assembly	H012150-01
LEE Valve (For Aux Valve Manifold)	REL-1061
Kicker Assembly	H012140
Humidifier Assembly	H012160

Part Description	Part Number
Reservoir Assembly	H012155
Chassis Cooling Fan	C020058
Fan Filter Kit (For Chassis Cooling Fan)	H010044
H2S Converter	H011105-51
Reaction Cell Assembly	H012100
Heater Thermistor Assembly	C020074
SO2 UV Lamp Assembly	C020076
U340 Glass Filter (PMT End of Reaction Cell)	H012114
UV Filter (UV Lamp End of Reaction Cell)	H012116
Plano-Convex Lens (UV Lamp End of Reaction Cell)	H012117
Bi-Convex Lens (PMT End of Reaction Cell)	H012118
Optical Bench Assembly	H012130
SO2 PMT (For Optical Bench)	H012132
Power Supply for PMT (For Optical Bench)	C020050-02
Cooler, Thermistor Assembly (For Optical Bench)	C020088
Ecotech Tygon Tubing, 25ft Length	T010011-01
240 V External Vacuum Pump	P030004
110 V External Vacuum Pump	P030005

9.5 Plumbing Schematic – (PN: D020019)

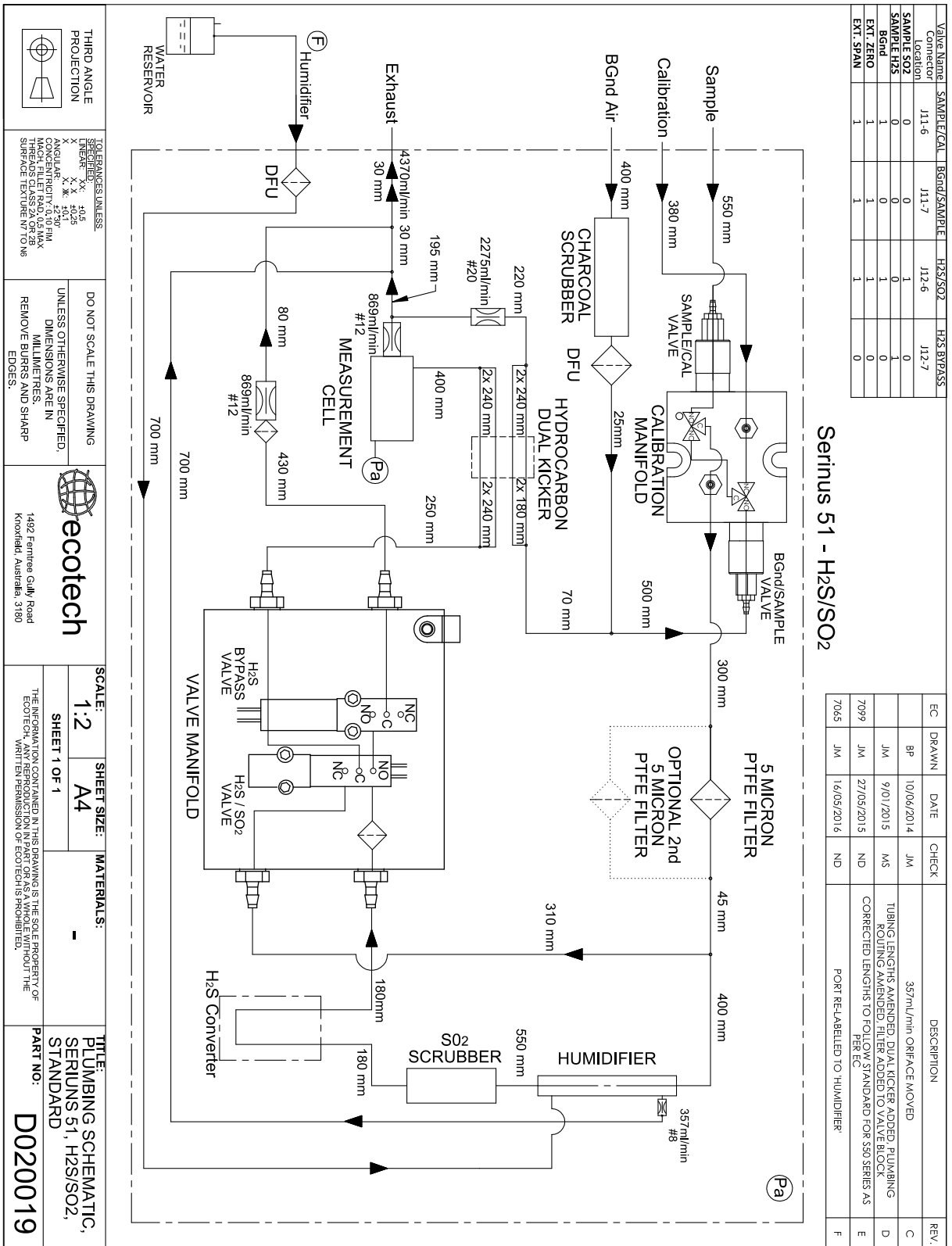

9.6 Block Wiring Schematic – (PN: D020105)

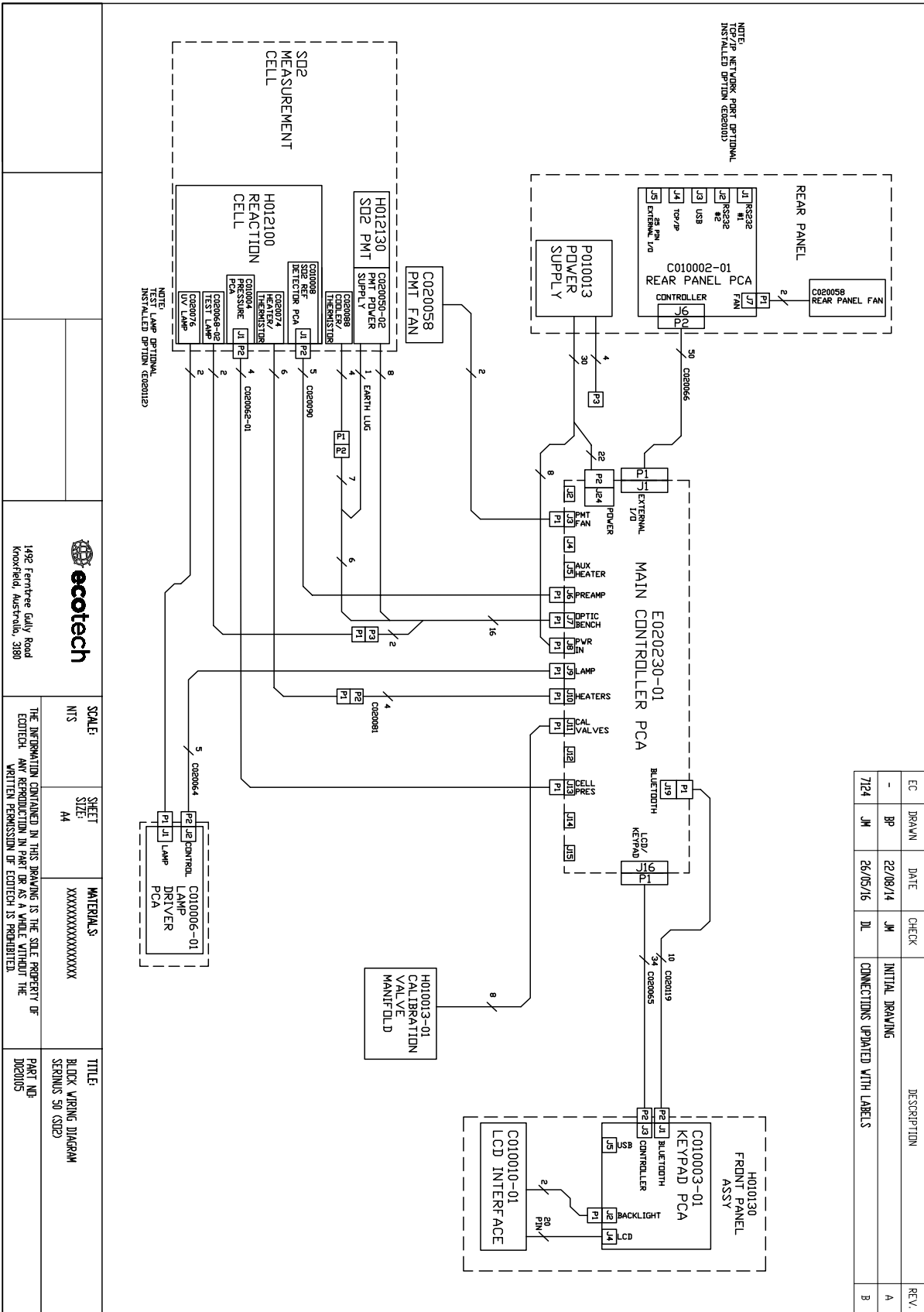

REV.	DESCRIPTION	CHECK	DATE	DRAWN	EC
A	INITIAL DRAWING	JM	22/08/14	BP	-
B	CONNECTIONS UPDATED WITH LABELS	DL	26/05/16	JM	7/24



1492 Ferritree Gully Road
Knoxfield, Australia, 3180

SCALE:	SHEET	MATERIALS:
NTS	SIZE: A4	XXXXXXXXXXXXXXXXXXXX

THE INFORMATION CONTAINED IN THIS DRAWING IS THE SOLE PROPERTY OF ECOTECH. ANY REPRODUCTION IN PART OR AS A WHOLE WITHOUT THE WRITTEN PERMISSION OF ECOTECH IS PROHIBITED.

TITLE:	PART NO:
BLOCK WIRING DIAGRAM SERINUS 50 (SD2)	D02005

9.7 Reaction Cell Assembly– (PN: H012100)

ITEM NO.	PART NUMBER	DESCRIPTION	Default/Qty.
1	H012101-01	REACTION CELL, SO2	1
2	H012106	PLUG, SO2 CELL	1
3	ORL1019	O-RING 88038, VITON	1
4	H012109	BAFFLE	1
5	CO10028	O-RING 1.364ID X 0.070W	1
6	H012110	DUMP ASSY., SO2, GAS ANALYZER	1
7	CO10029	O-RING 0.799ID X 0.103W	1
8	H012114	FILTER GLASS, U-340	1
9	H012102	RETAINER, PMT FILTER, SO2	1
10	CO10027	O-RING 0.987ID X 0.103W	1
11	H012117	LENS PLANO-CONVEX	1
12	H012103	RETAINER, LENSE, CONVEX	1
13	H012120	LAMP HOLDER ASSY., SO2, GAS ANALYZER	1
14	SEMSPHBY10	MAX10 SEMS PAN HEAD PHILLIPS SCREW	15
15	H012105	BRACKET, CELL, SO2	2
16	SEMSPHBY16	MAX16 SEMS PAN HEAD PHILLIPS SCREW	4
17	PHBY40	MAX40 PAN HEAD PHILLIPS SCREW	4
18	CSK M4 by 6	MAX4 CSK PHILLIPS SCREW	4
19	CO20074	HEATER AND THERMISTOR ASSY, DUAL, SERINUS	1
20	PHBY6	MAX6 PAN HEAD PHILLIPS SCREW	2
21	H012126	OPTICAL BENCH ADAPTOR ASSY., SO2, GAS ANALYZER	1
22	-	M4 SPRING WASHER	4
23	FO30033-01	FITTING KTYNAR MALE BRANCH TEE 1/4" - 1/8"NPT	1
24	H010043-19	ORRICE 20 ML	1
25	CO10013	O-RING 5/32ID X 1/16W, VITON	2
26	H010007	ADAPTOR, 1/4" FITTING TO 1/8" BARB	2
27	FO30025	FITTING SWAGELOK MALE ELBOW 1/8" - 1/8"NPT S/S	1
28	CO10042	O-RING, 88032, VITON	1
29	H010043-11	ORRICE 12 ML	1

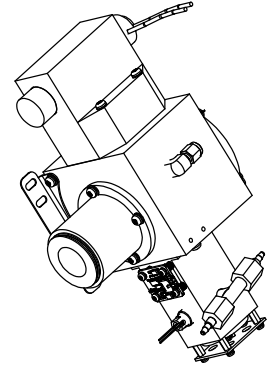

EC	DRAWN	DATE	CHECK	DESCRIPTION	REV.
-	V.C.	14/01/08	M.S.	INITIAL DRAWING	X1
	VC	17/02/10	MT	FILTER CHANGED FROM 002-053500 TO H012114	B
	VC	2/07/13	MT	ORL1019 WAS CO10006	C
	BP	9/08/2013	JM	O-RING ADDED	D
	JM	12/03/2015	MT	ORRICE LOCATION CORRECTED TO REFLECT PRODUCTION BUILD. NOTE ADDED FOR CONVEX MIRROR	E
	JM	9/05/2016	ND	SAMPLE ORRICE CORRECTED TO 12 ML (H010043-11)	F

<p>THIRD ANGLE PROJECTION</p>	<p>INDICATED DIMENSIONS ARE IN MILLIMETERS UNLESS OTHERWISE SPECIFIED.</p> <p>UNLESS OTHERWISE SPECIFIED, DIMENSIONS ARE IN MILLIMETERS. REMOVE BURRS AND SHARP EDGES.</p>	<p>1/827 Referring to the Head Drawing, Revision, V.131</p>	<p>SCALE: -</p> <p>SHEET SIZE: A4</p> <p>MATERIALS: -</p>	<p>TITLE: REACTION CELL ASSY, SO2, GAS ANALYZER</p> <p>PART NO: H012100</p>
-------------------------------	--	---	---	---

THE INFORMATION CONTAINED IN THIS DRAWING IS THE SOLE PROPERTY OF ECOTECH. ANY REPRODUCTION IN PART OR AS A WHOLE WITHOUT THE WRITTEN PERMISSION OF ECOTECH IS PROHIBITED.

9.8 Lamp Holder Assembly– (PN: H012120)

EC	DRAWN	DATE	CHECK	DESCRIPTION	REV.
	V.C.	27/03/08	D.B.	INITIAL DRAWING	A
7083	JM	12/03/2015	MT	NOTE ADDED FOR H012116, UV LAMP MOVED TO REFLECT CORRECT FAN LENT	B

ITEM NO.	PART NUMBER	DESCRIPTION	QTY.
1	H012121	LAMP HOLDER, SO2 CELL	1
2	C020076	LAMP ASSY, UV, SO2, GAS ANALYZER	1
3	H012125	COLLET, SHORT, UV LAMP	1
4	H012124	COLLET, LONG, UV LAMP	1
5	H012123	RETAINER, LAMP FILTER, SO2	1
6	H012122	BAFFLE, LAMP, SO2 CELL	1
8	F050010	M 3X10 SEM SPAN HEAD PHILLIPS SCREW	3
9	H012116	LENS UV FILTER	1
10	O010004	O-RING BS115, VITON	2
11	O010026	O-RING 7/8D X 1/16W, VITON	1



<p>TOLERANCES UNLESS SPECIFIED:</p> <p>LINEAR: XX: ±0.5 X: ±0.25 X.X: ±0.1 X.XX: ±0.1</p> <p>ANGULAR: CONCENTRIC: ±0.10 MM TAPER: ±0.05 MAX MACH. FLET: ±0.03 MAX SURFACE: ±0.06</p>	<p>DO NOT SCALE THIS DRAWING</p> <p>UNLESS OTHERWISE SPECIFIED, DIMENSIONS ARE IN MILLIMETERS, REMOVE BURRS AND SHARP EDGES.</p>	<p>THIRD ANGLE PROJECTION</p>	<p>SCALE:</p> <p>SHEET 1 OF 2</p> <p>A4</p> <p>MATERIALS:</p> <p>TITLE:</p> <p>LAMP HOLDER ASSY, SO2 GAS ANALYZER</p> <p>PART NO:</p> <p>H012120</p>
--	--	-------------------------------	--

THE INFORMATION CONTAINED IN THIS DRAWING IS THE SOLE PROPERTY OF ECOTECH. ANY REPRODUCTION IN PART OR AS A WHOLE WITHOUT THE WRITTEN PERMISSION OF ECOTECH IS PROHIBITED.

1492 Fernree Gully Road
Knoxfield, Australia, 3180

ecotech
www.ecotech.com.au

9.9 Dump Assembly- (PN: H012110)

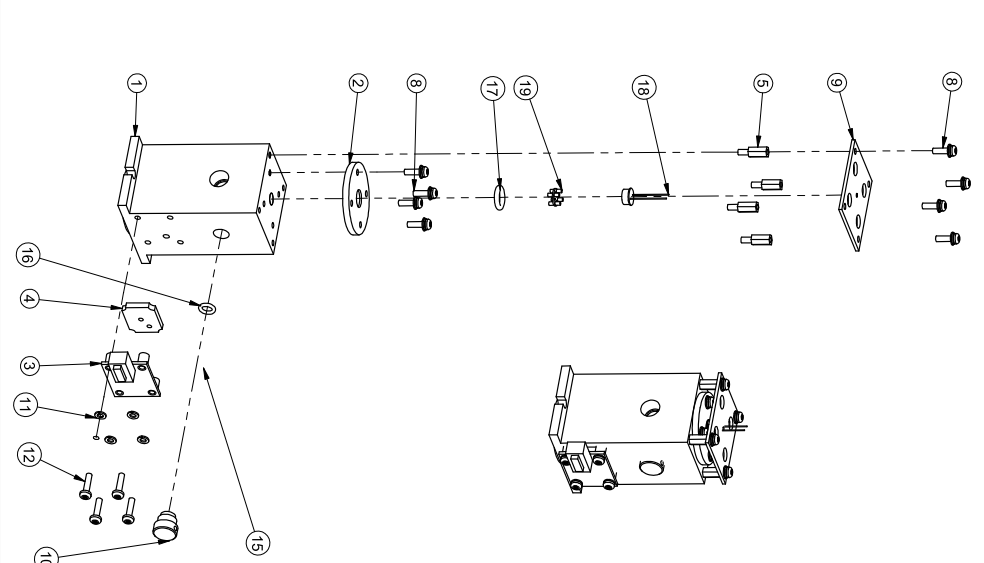
 <p>THIRD ANGLE PROJECTION</p>	<p>DIMENSIONS UNLESS SPECIFIED:</p> <p>LINEAR XX 20.5 X X X 20.25 ANGULAR X X 2°30' CONCENTRICITY 0.10 MM MATCH FILET RAD. 0.5 MAX THREADS CLASS A OR B SPRACES TO DRAWING</p>	<p>DO NOT SCALE THE DRAWING</p> <p>UNLESS OTHERWISE SPECIFIED, DIMENSIONS ARE IN MILLIMETRES. REMOVE BURRS AND SHARP EDGES.</p>	 <p>ecotech Environmental Monitoring Solutions 1492 Rennie Quay, Chad Knockfield, Australia, 3180</p>	<p>SCALE: 1:3</p> <p>SHEET 1 OF 2</p>	<p>SHEET SIZE: A4</p> <p>MATERIALS:</p>	<p>TITLE: DUMP ASSY, SO2, SERINUS</p> <p>PART NO: H012110</p>	<p>EC DRAWING V.C.</p> <p>DATE 26/03/08</p> <p>CHECK D.B.</p> <p>DESCRIPTION INITIAL DRAWING</p> <p>REV. A</p>																																																																
																																																																							
<table border="1" style="width: 100%; border-collapse: collapse;"> <thead> <tr> <th>ITEM NO.</th> <th>PART NUMBER</th> <th>DESCRIPTION</th> <th>QTY.</th> </tr> </thead> <tbody> <tr> <td>1</td> <td>H012111</td> <td>DUMP, SO2</td> <td>1</td> </tr> <tr> <td>2</td> <td>H012112</td> <td>RETAINER, REFERENCE SENSOR SO2</td> <td>1</td> </tr> <tr> <td>3</td> <td>C010004</td> <td>PC A, PRESSURE GAUGE GAS ANALYZER</td> <td>1</td> </tr> <tr> <td>4</td> <td>H010037</td> <td>GASKET, PRESSURE SENSOR</td> <td>1</td> </tr> <tr> <td>5</td> <td>H010037</td> <td>spacer, hex, 10mm, male-female</td> <td>4</td> </tr> <tr> <td>8</td> <td>SEM19HBY10</td> <td>M3X10 SEMIS/PAN HEAD PHILLIPS SCREW</td> <td>8</td> </tr> <tr> <td>9</td> <td>C010008</td> <td>PCA SO2 REF DETECTOR SERINUS</td> <td>1</td> </tr> <tr> <td>10</td> <td>H010026</td> <td>PLUG, TEST LAMP</td> <td>1</td> </tr> <tr> <td>11</td> <td>3 mm split</td> <td>M3 SPRING WASHER</td> <td>4</td> </tr> <tr> <td>12</td> <td>PH3BY12</td> <td>M3X12 PAN HEAD PHILLIPS SCREW</td> <td>4</td> </tr> <tr> <td>15</td> <td>H010002</td> <td>WINDOW, QUARTZ TEST LAMP</td> <td>1</td> </tr> <tr> <td>16</td> <td>O010021</td> <td>O-RING 0.208ID X 0.07W</td> <td>1</td> </tr> <tr> <td>17</td> <td>O010031</td> <td>O-RING 5/16 X 1/2 X 3/32 VITON</td> <td>1</td> </tr> <tr> <td>18</td> <td>S030007</td> <td>DIODE PHOTO-DETECTOR S12</td> <td>1</td> </tr> <tr> <td>19</td> <td>H012127</td> <td>SPACER TO-5 Bivar # 514-240</td> <td>1</td> </tr> </tbody> </table>								ITEM NO.	PART NUMBER	DESCRIPTION	QTY.	1	H012111	DUMP, SO2	1	2	H012112	RETAINER, REFERENCE SENSOR SO2	1	3	C010004	PC A, PRESSURE GAUGE GAS ANALYZER	1	4	H010037	GASKET, PRESSURE SENSOR	1	5	H010037	spacer, hex, 10mm, male-female	4	8	SEM19HBY10	M3X10 SEMIS/PAN HEAD PHILLIPS SCREW	8	9	C010008	PCA SO2 REF DETECTOR SERINUS	1	10	H010026	PLUG, TEST LAMP	1	11	3 mm split	M3 SPRING WASHER	4	12	PH3BY12	M3X12 PAN HEAD PHILLIPS SCREW	4	15	H010002	WINDOW, QUARTZ TEST LAMP	1	16	O010021	O-RING 0.208ID X 0.07W	1	17	O010031	O-RING 5/16 X 1/2 X 3/32 VITON	1	18	S030007	DIODE PHOTO-DETECTOR S12	1	19	H012127	SPACER TO-5 Bivar # 514-240	1
ITEM NO.	PART NUMBER	DESCRIPTION	QTY.																																																																				
1	H012111	DUMP, SO2	1																																																																				
2	H012112	RETAINER, REFERENCE SENSOR SO2	1																																																																				
3	C010004	PC A, PRESSURE GAUGE GAS ANALYZER	1																																																																				
4	H010037	GASKET, PRESSURE SENSOR	1																																																																				
5	H010037	spacer, hex, 10mm, male-female	4																																																																				
8	SEM19HBY10	M3X10 SEMIS/PAN HEAD PHILLIPS SCREW	8																																																																				
9	C010008	PCA SO2 REF DETECTOR SERINUS	1																																																																				
10	H010026	PLUG, TEST LAMP	1																																																																				
11	3 mm split	M3 SPRING WASHER	4																																																																				
12	PH3BY12	M3X12 PAN HEAD PHILLIPS SCREW	4																																																																				
15	H010002	WINDOW, QUARTZ TEST LAMP	1																																																																				
16	O010021	O-RING 0.208ID X 0.07W	1																																																																				
17	O010031	O-RING 5/16 X 1/2 X 3/32 VITON	1																																																																				
18	S030007	DIODE PHOTO-DETECTOR S12	1																																																																				
19	H012127	SPACER TO-5 Bivar # 514-240	1																																																																				

9.10 Optical Bench Assembly – (PN: H012130)

THIRD ANGLE PROJECTION



TOLERANCES UNLESS SPECIFIED:

LINEAR: XX: ±0.5
X: X: ±0.25
X: X: ±0.1

ANGULAR: X: X: ±2.30°

CONCENTRICITY: 0.010 PM

PERFECT FORM: 0.05 MAX

THICKNESS: 0.05 MAX

SURFACE FINISH: N7 TO N6

DO NOT SCALE THIS DRAWING

UNLESS OTHERWISE SPECIFIED, DIMENSIONS ARE IN MILLIMETERS. REMOVE BURRS AND SHARP EDGES.

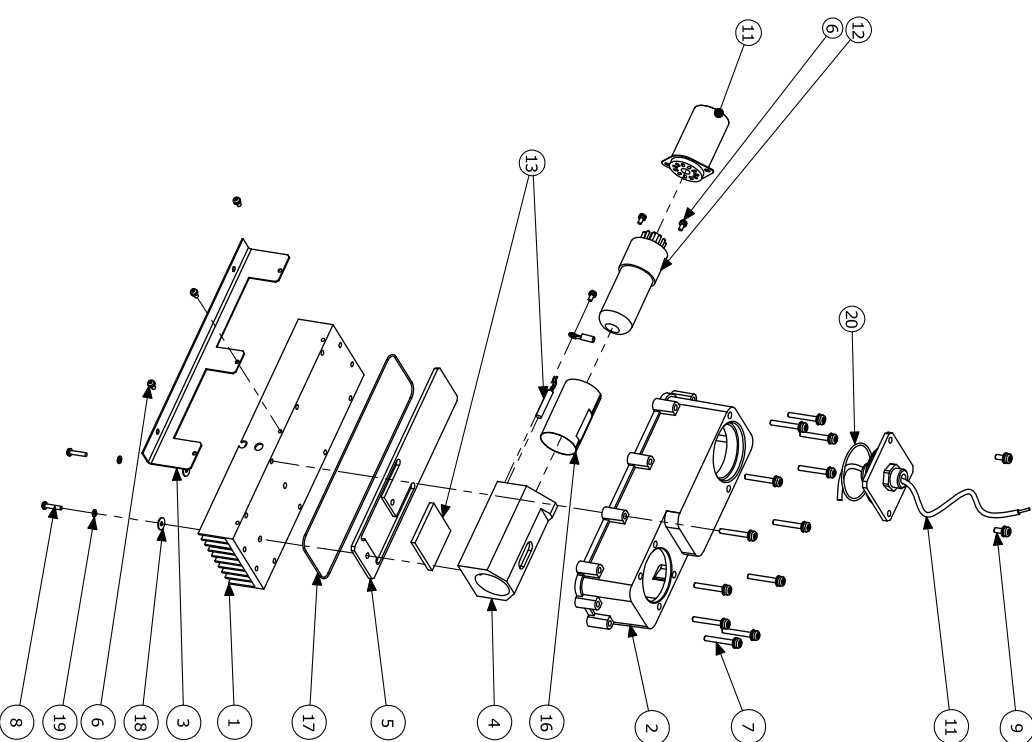

SCALE:

SHEET SIZE: A4

SHEET 1 OF 2

THE INFORMATION CONTAINED IN THIS DRAWING IS THE SOLE PROPERTY OF ECOTECH. ANY REPRODUCTION IN PART OR AS A WHOLE WITHOUT THE WRITTEN PERMISSION OF ECOTECH IS PROHIBITED.

MATERIALS:

TITLE: OPTICAL BENCH ASSY. SO2 GAS ANALYZER

PART NO.: H012130

ITEM NO.	PART NUMBER	DESCRIPTION	QTY.
1	H011209	HEAT SINK SO2 AND NOX	1
2	H011207	HOUSING OPT BENCH, INJ MOUNTED	1
3	H010006	BRACKET, HEAT SINK, GAS ANALYZER	1
4	H011210	COLD BLOCK, SIDE ON PMT, GAS ANALYZER	1
5	H011208	SPACER HEATSHIELD, H SINK	1
6	F050011	M3X6 SEMSPAN HEAD PHILLIPSSCREW	6
7	F050024	M4 X 30 SEMS	12
8	FAS-M3SS-5	M3X16 PAN HEAD PHILLIPSSCREW	2
9	F050012	M4 X 10 SEMS	2
11	C020050-02	CABLE, PMT, SO2, GAS ANALYZER	1
12	H012132	TUBE, SIDE ON PMT, R1527	1
13	H011202	PHOTOMULTIPLIER TUBE SO2 THERMOELECTRIC COOLER, 12VDC ** WITH 8" LEADS	1
14	S030006	THERMISTOR ASSY. ENCASSEMBENT	1
16	H011204	SHIELD REF, SIDE ON PMT	1
17	O010018	O-RING 5.3/4D X 3/32W, VITON	1
18	3 mmx10		2
19	3 mmx6	M3X6 FLATWASHER	2
20	O010022	O-RING 1.739D X 0.07W, VITON	1

EC	DRAWN	DATE	CHECK
-	V.C.	10/01/08	M.S.
7083	JM	12/03/2015	MT

DESCRIPTION	
INITIAL DRAWING	
DRAWING UPDATED TO REFLECT CORRECT BUILD	
	REV. X1
	B

9.11 Aux Manifold Assembly- (PN: H012150-01)

ITEM NO.	P/N	DESCRIPTION	QTY.
1	H012151	MANIFOLD VALVE GAS SELECTOR, SO2 VARIANT GAS ANALYZERS	1
2	REL-1061	VALVE VITON C/W VITON SEAL	2
3	H030084	SADDLE VALVE, LEE	2
4	H030086	CABLE CLAMP, WIRE 1/8 DIA NATURAL, P CLIP	1
5	F030006	FITTING, MALE CONNECTOR 1/8NPT - 1/8 BARB, KVMAR	4
6	O010013	O-RING 5/32D X 1/16W, VITON	1
7	H010047-01	FILTER, SINTERED W/ O-RING GROOVE	1
8	C020111	MICROFIT RECEPTACLE FREE 10 WAY MOLEX	1
9	C030110	CRIMP SOCKET, MICROFIT, MOLEX	4
10	F050043	M2 X 10 SHCS, 12.9 GRADE	4

VALVE NUMBER	PN CONNECTIONS
1	1 + 6
2	2 + 7

EC	DRAWN	DATE	CHECK	DESCRIPTION	REV.
6956	M.S.	21/10/10	V.C.	DRAWN	A
	VC	29/06/2011	MS	O-RING, SPRING AND O-RING REMOVED FROM MANIFOLD ASSY WIRE LENGTH ADDED	B

TOLERANCES UNLESS SPECIFIED:	DO NOT SCALE THIS DRAWING	UNLESS OTHERWISE SPECIFIED, DIMENSIONS ARE IN MILLIMETRES. REMOVE BURRS AND SHARP EDGES.	SCALE:
FRACTIONAL: X, XX, XXX, XXXX DECIMAL: X.X, X.XX, X.XXX, X.XXXX ANGULAR: X.X, X.XX, X.XXX, X.XXXX CONCENTRICITY: 0.10 MIN MACH. FINISH: 0.5 MAX THREADS: CLASS 2A OR 2B SURFACE FINISH: TV TO N6			SHEET SIZE: A4
THIRD ANGLE PROJECTION		MATERIALS:	
TITLES: MANIFOLD BLOCK ASSY, SO2 VARIANT GAS ANALYZERS		THE INFORMATION CONTAINED IN THIS DRAWING IS THE SOLE PROPERTY OF ECOTECH. ANY REPRODUCTION IN PART OR AS A WHOLE WITHOUT THE WRITTEN PERMISSION OF ECOTECH IS PROHIBITED.	
PART NO: H012150-01		SHEET 1 OF 2	

9.12 Calibration Manifold Assembly– (PN: H010013-01)

EC	DRAWN	DATE	CHECK	DESCRIPTION	REV.
	VC	16/03/10		INITIAL DRAWING	X1
	BP	22/08/2014	JM	BOM ADDED	B
	ND	9/11/2015	JM	COMPANY LOGO UPDATED IN TITLE BLOCK	C
7154	JM	3/05/2016	ND	FITTING CHANGED AS PER EC	D

VALVE 1
CABLE LENGTH 190 mm
CONNECT TO PINS 1 AND 6
ON THE CONNECTOR

VALVE 2
CABLE LENGTH 250 mm
CONNECT TO PINS 2 & 7
ON THE CONNECTOR

CABLE TIE
2-PLACES

MICROFIT RECEPTACLE
FREE TO WAY MOLEX

NOTES:
1. VALVES MUST BE FREE OF DIRT, GREASE OR ANY OTHER FOREIGN MATERIAL.
2. F030006-01 THREADS MUST BE SEALED WITH SWAGelok THREAD TAPE.
3. MANIFOLD BLOCK MUST BE FREE OF DIRT GREASE OR ANY OTHER FOREIGN MATERIAL.
4. ASSEMBLY MUST PASS LEAK TEST UNDER VACUUM OF -90 KPA. MAX DROP ALLOWED IS 2 KPA IN 5 MINS.

ITEM NO.	PART NUMBER	DESCRIPTION	QTY.
1	H010014-01	VALVE MANIFOLD	1
2	H010042	VALVE MFLD, 3 WAY, 12VDC	2
3	F030006-01	FITTING, MALE CONNECTOR 1/8NPT - 1/8 BARB, KYNAR	4

TOLERANCES UNLESS SPECIFIED:

LINEAR: XX: ±0.5
X: ±0.25
ANGULAR: X: X: ±0.1
X: X: ±0.1

CONCENTRICITY: ±0.101mm
MACH. FILER RFD. 0.05mm X
SURFACE FINISH: 3.2
SURFACE TEXTURE: 17 TO 16

DO NOT SCALE THIS DRAWING

UNLESS OTHERWISE SPECIFIED, DIMENSIONS ARE IN MILLIMETERS. REMOVE BURRS AND SHARP EDGES.

THIRD ANGLE PROJECTION

SCALE: NTS: A4
SHEET 1 OF 1
MATERIALS: AS NOTED

1492 Fernilee Quay, Road
Knoxfield, Australia, 3180

ecotech

THE INFORMATION CONTAINED IN THIS DRAWING IS THE SOLE PROPERTY OF ECOTECH. ANY REPRODUCTION IN PART OR AS A WHOLE WITHOUT THE WRITTEN PERMISSION OF ECOTECH IS PROHIBITED.

PART NO: H010013-01

9.13 Valve Assembly – (PN: H010042)

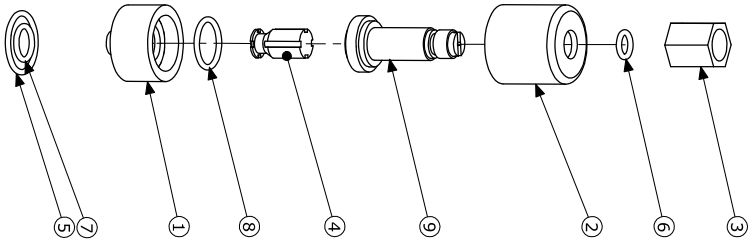

ITEM NO.	PART NUMBER	QTY.
1	BODY	1
2	SOLENOID COIL	1
10	NUT	1
4	PLUNGER	1
5	O010016	1
6	O010015	1
7	O010010	1
8	O010023	1
9	STEM	1

STEPS TO REPLACE O-RINGS:

1. MARK THE SOLENOID COIL WITH A PERMANENT MARKER TO IDENTIFY THEIR RESPECTIVE VALVES AND THEIR POSITION ON MANFOLD BLOCK
2. SECURE THE 3-WAY VALVE UPRIGHT INTO A LARGE VICE WITH PROTECTION AROUND ITS BODY TO PREVENT SCRATCH OR DAMAGE TO VALVE
3. REMOVE NUT FROM THE TOP OF THE 3-WAY VALVE USING A 9/16" SPANNER
4. REMOVE SMALL O-RING FROM AROUND 3 WAY VALVE USING 2 MM FLAT SCREW DRIVER
5. LIFT OFF THE SOLENOID COIL FROM THE 3-WAY VALVE THEN UNSCREW THE SHAFT FROM THE BASE USING A LARGE FLAT SCREW DRIVER. WHILE UNSCREWING TAKE CARE THAT THE INTERNAL PLUNGER DOES NOT FALL OUT
6. REPLACE THE INTERNAL O-RING WITH O010023
7. ASSEMBLE THE SHAFT ALONG WITH PLUNGER BACK IN ITS POSITION
8. ASSEMBLE THE SOLENOID WITH ITS RESPECTIVE VALVE.
9. ASSEMBLE NEW O010015 O-RING SUPPLIED
10. ASSEMBLE THE NUT ON TOP OF 3-WAY VALVE.
11. ASSEMBLE O010016 AND O010010 O-RINGS ON THE BOTTOM OF THE VALVE.
12. ASSEMBLE VALVE BACK IN MANFOLD BLOCK

This page is intentionally blank.

Appendix A. Advanced Protocol

The Advanced protocol allows access to the full list of instrument parameters.

A.1 Command Format

All commands and responses sent to and from the Instrument will be in the following packet format to ensure data is reliable.

Table 13 – Packet Format

1	2	3	4	5	6 ... 5+n	6+n	7+n
STX (2)	Serial ID	Command	ETX (3)	Message Length (n)	Message	Checksum	EOT (4)

Where:

<STX> ASCII Start of Text = 0x02 hex.

Serial ID The Serial ID assigned in the **Main Menu** → **Communications Menu** → **Serial Communication Menu**.

<ETX> ASCII End of Text = 0x03 hex.

Checksum The XOR of the individual bytes except for STX, ETX, EOT and Checksum.

Message length Must be in the range 0 to 32. Responses from the instrument can have a message Length of 0 to 255.

<EOT> ASCII End of Transmission = 0x04 hex.

Examples

A basic request for Primary gas data would be as follows:

Table 14 – Example: Primary Gas Request

Byte Number	1	2	3	4	5	6	7	8
Description	STX	ID	Command	ETX	Message Length	Primary Gas Conc	Checksum	EOT
Value	2	0	1	3	1	50	50	4
Checksum Calculation		0	$0 \oplus 1 = 1$		$1 \oplus 1 = 0$	$0 \oplus 50 = 50$	50	

And a sample response:

Table 15 – Example: Primary Gas Response

Byte Number	1	2	3	4	5	6	Continued in next table.
Description	STX	ID	Command	ETX	Message Length	Primary Gas Conc	
Value	2	0	1	3	5	50	
Checksum Calculation		0	$0 \oplus 1 = 1$		$1 \oplus 5 = 4$	$4 \oplus 50 = 54$	

Table 16 – Example: Primary Gas Response (continued)

Byte Number	7	8	9	10	11	12
Description	IEEE representation of 1.00				Checksum	EOT
Value	63	128	0	0	50	4
Checksum Calculation	$54 \oplus 63 = 9$	$9 \oplus 128 = 137$	$137 \oplus 0 = 137$	$137 \oplus 0 = 137$	137	

A.2 Commands

A.2.1 Communication Error

Where:

- Command byte 0
- Message byte 1 0
- Message byte 2 0..7

If the command byte of a response is 0, this indicates an error has occurred. The message field will be 2 bytes long, where the 2nd byte indicates the error according to the following table.

Table 17 – List of Errors

Error #	Description
0	Bad Checksum received
1	Invalid Parameter Length
2	Invalid Parameter
3	Internal Data Flash Erase in Progress unable to return data for a few seconds
4	Unsupported Command.
5	Another process is collecting data – unable to service request.
6	MemStick No Connected
7	MemStick Busy

A.2.2 Get IEEE Value

Where:

- Command byte 1
- Message byte 1 Index from List of Parameters
- Message byte 2..32 Additional indexes (optional)

This command requests the value of an instrument parameter. The message field byte contains the index of the parameter requested, as described in the List of Parameters.

Up to 32 indexes can be supplied in a single request. The response has 5 bytes for each parameter requested – the first byte is the parameter index and the next four are the IEEE representation of the current value.

Example

A request with a message field of 50,51,52 to a Serinus S40 would return a 15 byte message as shown below:

Table 18 – Example: Get IEEE Response data

1	2	3	4	5	6	7	8	9	10	11	12	13	14	15
50	NO reading				51	NOx reading				52	NO2 reading			

A.2.3 Set Calibration Mode

Where:

- Command byte 4
- Message byte 1 85
- Message byte 2-5 The IEEE representation of 0, 1, 2, or 3
 - 0 puts the instrument into Measure mode (0,0,0,0)
 - 1 puts the instrument into Cycle mode (63,128,0,0)
 - 2 puts the instrument into Zero mode (64,0,0,0)
 - 3 puts the instrument into Span mode (64,64,0,0)

This command puts the instrument into a calibration mode (the same as going to the Calibration menu and choosing a Cal. Mode).

Example

A request with a command of 4 and a message field of 85,64,64,0,0 would place the instrument into Span mode.

A.2.4 Set Calibration

Enters a new calibration value: the same as entering Span Calibrate or Zero Calibrate on the calibration menu.

Where:

- Command byte 18
- Message byte 1 0, 1, 2, or 3 where
 - 0 = Span
 - 1 = Zero (first zero gas)
 - 2 = Zero (second zero gas)
 - 3 = Zero (Third zero gas)
- Message byte 2-5 The IEEE representation of the calibration value.

A.3 List of Parameters

Note: Parameters are for all Serinus series analysers and may not be applicable to an individual instrument.

Table 19 – Advanced Protocol Parameter List

#	Description	Notes
1	Cal/Zero Valve	0 = Zero, 1 = Cal
2	Internal Span Valve	0 = Off, 1 = On
3	Positive Supply	Positive analog supply voltage
4	Gas 5 Avg.	Average of the readings (for Gas 5) of the last n minutes where n is the averaging period E.g. Nx
5	Pregain	S30H linearization coefficient gain
6	Sample/Cal Valve	0 = Sample, 1 = Cal/Zero
7	NOx Measure Valve	0 = NO, 1 = NOx
8	NOx Bypass Valve	0 = NO, 1 = NOx
9	NOx Backgnd Valve	0 = Off, 1 = On
10	Valve Sequencing	0 = Off, 1 = On
11	LCD Contrast Pot	0 = Lightest, 255 = Darkest
12	SO2 Ref Zero Pot	S50 Reference zero pot
13	CO Input Pot	S30 Input pot
14	CO Reference Test Pot	Not Used
15	CO Measure Pot	Not Used

16	High Volt Adjust Pot	PMT High Voltage Adjust Pot for S50 & S40
17	SO2 Lamp Adjust Pot	S50 Lamp adjustment Pot
18	O3 Lamp Adjust Pot	S10 Lamp adjustment Pot
19	O3 Meas. Zero Pot (C)	S10 Signal zero measure (coarse)
20	O3 Meas. Zero Pot (F)	S10 Signal zero measure (fine)
21	PMT Fan Pot	Optical Bench fan speed control pot
22	Rear Fan Pot	Chassis Fan speed control pot
23	Pump Fine Pot	Internal Pump speed fine pot
24	Pump Coarse Pot	Internal Pump speed coarse pot
25	Analog input 0	SO2 Reference signal
26	Analog input 1	CO Reference signal
27	Analog input 2	O3 Reference signal
28	Analog input 3	SO2 & O3 Lamp current
29	Analog input 4	Flow block pressure
30	Analog input 5	Cell pressure
31	Analog input 6	Ambient pressure
32	Analog input 7	Raw ADC calibration input
33	Analog input 8	Reserved
34	Analog input 9	Concentration data
35	Analog input 10	Reserved
36	Analog input 11	Reserved
37	Analog input 12	Raw analog to digital count for external analog input 0. 0-5V= 0-32766 A/D counts
38	Analog input 13	Raw analog to digital count for external analog input 1. 0-5V= 0-32766 A/D counts
39	Analog input 14	Raw analog to digital count for external analog input 2. 0-5V= 0-32766 A/D counts
40	Analog input 15	Reserved
41	CO Meas. Zero Pot (coarse)	S30 Measure ZERO coarse adjustment Pot
42	CO Meas. Zero Pot (fine)	S30 Measure ZERO fine adjustment Pot
43	SO2 Input Pot	SO2 Measure Signal Gain Pot
44	SO2 Ref. Gain Pot	SO2 Reference Signal Gain Pot
45	SO2 Meas. Zero Pot	SO2 Measure zero pot
46	O3 Input Pot	O3 Input signal gain pot
47	Diagnostic Test Pot	The Diagnostic mode adjustment pot for all the analysers except for S30
48	NOx Input Pot	PMT signal input gain control FOR NOx

49	PGA Gain	1, 2, 4, 8, 16, 32, 64, 128
50	Gas 1 Inst.	Primary gas concentration currently displayed on the front screen E.g. NO
51	Gas 2 Inst.	Secondary gas concentration currently displayed on front screen E.g. NOx
52	Gas 3 inst.	Calculated gas concentration currently displayed on front screen E.g. NO2
53	Gas 1 Avg.	Average of the readings (for Gas1) of the last n minutes where n is the averaging period
54	Gas 2 Avg.	Average of the readings (for Gas2) of the last n minutes where n is the averaging period
55	Gas 3 Avg.	Average of the readings (for Gas3) of the last n minutes where n is the averaging period
56	Instrument Gain	Current calibration value (default is 1.0)
57	Serial ID	Multidrop or Bayern-Hessen gas id
58	Bayern-Hessen ID	For multigas instruments only
59	Decimal Places	2-5
60	Noise	Instrument noise
61	Gas 1 Offset	An offset applied to Gas 1
62	Gas 3 Offset	An offset applied to Gas 3
63	Flow Temperature	Temperature of the flow block
64	Lamp Current	Lamp current in mA E.g 35mA
65	Digital Supply	Digital Supply voltage (should always read close to 5 volts)
66	Conc. Voltage	Concentration Voltage
67	High Voltage	High Voltage reading for PMT
68	Ozonator	0 = Off, 1 = On
69	Control Loop	0 = Off, 1 = On (default is On)
70	Diagnostic Mode	0 = Operate 1 = Preamp 2 = Electrical 3 = Optical (default is Operate)
71	Gas Flow	Units in slpm
72	Gas Pressure	Units in torr
73	Ambient Pressure	Units in torr
74	12V Supply	The 12 volt Power supply voltage
75	Cell Temperature	Cell Temperature
76	Conv. Temperature	Converter Temperature

77	Chassis Temperature	Chassis Temperature										
78	Manifold Temp.	Manifold Temperature										
79	Cooler Temperature	Cooler Temperature										
80	Mirror Temperature	Mirror Temperature										
81	Lamp Temperature	Lamp Temperature										
82	IZS Lamp Temperature	O3 Lamp Temperature										
83	Instrument Status											
84	Reference Voltage	Units in Volts										
85	Calibration State	This variable has two different sets of values: <table border="1" data-bbox="874 674 1326 882"> <tr> <td>Set Calibration State</td> <td>Get IEEE Value</td> </tr> <tr> <td>0 = MEASURE</td> <td>0 = MEASURE</td> </tr> <tr> <td>1 = CYCLE</td> <td>1 = ZERO</td> </tr> <tr> <td>2 = ZERO</td> <td>2 = SPAN</td> </tr> <tr> <td>3 = SPAN</td> <td></td> </tr> </table>	Set Calibration State	Get IEEE Value	0 = MEASURE	0 = MEASURE	1 = CYCLE	1 = ZERO	2 = ZERO	2 = SPAN	3 = SPAN	
Set Calibration State	Get IEEE Value											
0 = MEASURE	0 = MEASURE											
1 = CYCLE	1 = ZERO											
2 = ZERO	2 = SPAN											
3 = SPAN												
86	Primary Raw Conc.	(For S40, before NOx background and gain)										
87	Secondary Raw Conc.	Only for multigas instruments (For S40, before NOx background and gain)										
88	S40 Backgnd Conc.	NOx Background Concentration (For S40, before gain)										
89	Cal. Pressure	Calibration Pressure										
90	Conv. Efficiency	Converter Efficiency										
91	Multidrop Baud Rate	0 = 1200 bps 1 = 2400 bps 2 = 4800 bps 3 = 9600 bps 4 = 14400 bps 5 = 19200 bps 6 = 38400 bps										
92	Analog Range AO 1	Maximum range value for analog output										
93	Analog Range AO 2											
94	Analog Range AO 3											
95	Output Type AO 1	Output Type										
96	Output Type AO 2	1 = Voltage										
97	Output Type AO 3	0 = Current										
98	Anlg Ofst/Rng AO1	Voltage Offset /Current Range										
99	Anlg Ofst/Rng AO2	0 = 0 % or 0-20mA										
100	Anlg Ofst/Rng AO3	1 = 5 % or 2-20mA										
101	F/Scale Volt AO 1	2 = 10 % or 4-20mA										
		5.0 Volt Calibration value										

102	F/Scale Volt AO 2	
103	F/Scale Volt AO 3	
104	Z Adj Volt AO 1	0.5 Volt Calibration value
105	Z Adj Volt AO 2	
106	Z Adj Volt AO 3	
107	Negative Supply	Negative analog supply
108	Digital Outputs	A single byte expressing the most recent state of the digital outputs
109	Digital Inputs	A single byte expressing the most recent state of the digital inputs
110	Instrument State	0 = SAMPLE FILL 1 = SAMPLE MEASURE 2 = SAMPLE FILL AUX 3 = SAMPLE MEASURE AUX 4 = SAMPLE FILL AUX2 5 = SAMPLE MEASURE AUX2 6 = BACKGROUND FILL 7 = BACKGROUND MEASURE 8 = BACKGROUND PURGE 9 = BACKGROUND FILL AUX 10 = BACKGROUND MEASURE AUX 11 = ZERO FILL 12 = ZERO MEASURE 13 = ZERO FILL AUX 14 = ZERO MEASURE AUX 15 = ZERO FILL AUX2 16 = MEASURE AUX2 17 = BACKGROUND FILL ZERO 18 = BACKGROUND MEASURE ZERO 19 = SPAN FILL 20 = SPAN MEASURE 21 = SPAN FILL AUX 22 = SPAN MEASURE AUX 23 = SPAN FILL AUX2 24 = SPAN MEASURE AUX2 25 = BACKGROUND FILL SPAN 26 = BACKGROUND MEASURE SPAN 27 = BACKGROUND PURGE SPAN 28 = ELECTRONIC ZERO ADJUST 29 = INSTRUMENT WARM UP 30 = BACKGROUND ADJUST FILL 31 = BACKGROUND ADJUST MEASURE

111	CO Lin. Factor A	CO Linearisation Factor A
112	CO Lin. Factor B	CO Linearisation Factor B
113	CO Lin. Factor C	CO Linearisation Factor C
114	CO Lin. Factor D	CO Linearisation Factor D
115	CO Lin. Factor E	CO Linearisation Factor E
116	Instrument Units	0 = ppm 1 = ppb 2 = ppt 3 = mg/m ³ 4 = µg/m ³ 5 = ng/m ³ 6 = %
117	Backgnd Meas. Time	In seconds.
118	Sample Fill Time	These parameters can be changed, but only temporarily; restarting the instrument will restore them to their default values.
119	Sample Measure Time	
120	Aux Measure Time	
121	Aux Smpl. Fill Time	
122	Backgnd Fill Time	
123	Zero Fill Time	
124	Zero Measure Time	
125	Span Fill Time	
126	Span Measure Time	
127	O3 Gen Coeff D	O3 Generator Coefficient D
128	Backgnd Pause Time	In seconds
129	Bkgnd Intrleav Fact	
130	Cal. Pressure 2	Calibration Pressure for 2 nd gas
131	2nd Instrument Gain	Unused (always reports 1.0)
132	Background voltage	Units in Volts
133	Perm Rate	Permeation rate of the gas in ng/min
134	Perm Flow	Total flow past the permeation chamber during an activated internal span mode. In ml/min
135	Perm Oven Setpoint	Set target temperature for the permeation oven. Default is 50 °C
136	Perm Oven Temp	Temperature readout of the Permeation oven. Units in °C
137	Ozone Target	Ozone Target for S10 IZS ozone generation
138	Conc Adjusted 1	Concentration value in PPM before filtering
139	Conc Adjusted 2	

140	Conc Adjusted 3	
141	Reserved	
142	Reserved	
143	IR Source	The S30 IR source voltage
144	Background (hrs)	The background interval in hours. 0.0 if disabled 0.25 for every 15 minutes 0.30 for every 20 minutes 0.50 for every 30 minutes 1.00 for every hour ... 24.00 for once a day
145	Cycle Time	In minutes
146	CO Cooler Pot	CO Cooler voltage adjustment POT
147	CO Source Pot	CO Source voltage adjustment POT
148	CO Test Meas. Pot	Diagnostics use only
149	CO Test Ref. Pot	Diagnostics use only
150	O3 Ref Average	S10 Background Average
151	PTF Correction (gas 1)	Pressure Temperature Flow Compensation Factor for first gas
152	PTF Correction (gas 2)	Pressure Temperature Flow Compensation Factor for second gas in dual gas analysers.
153	Inst. Cell Pressure	Instantaneous cell pressure
154	Manifold	Manifold Pressure in S40 instruments
155	Cell Press. (gas1)	Cell Pressure for Gas 1
156	Cell Press. (gas2)	Cell Pressure for Gas 2
157	Cell Press. (Bgnd)	Cell Pressure when in Background
158	Background	0 = the instrument is measuring a gas sample 1 = the instrument is measuring background air
159	Gas To Measure	S51 only; see Measurement Settings Menu 0 = Measure both gasses 1 = Measure SO2 only 2 = Measure H2S only
160	Valve States	Diagnostic use only
161	Temperature Units	0 = "°C" 1 = "°F" 2 = "K"

162	Pressure Units	0 = "torr" 1 = "psi" 2 = "mbar" 3 = "atm" 4 = "kPa"
163	Averaging Period	0 = "1 Min" 1 = "3 Mins" 2 = "5 Mins" 3 = "10 Mins" 4 = "15 Mins" 5 = "30 Mins" 6 = "1 Hr" 7 = "4 Hrs" 8 = "8 Hrs" 9 = "12 Hrs" 10 = "24 Hrs"
164	Filter Type	0 = NO FILTER 1 = KALMAN FILTER 2 = 10 SEC FILTER 3 = 30 SEC FILTER 4 = 60 SEC FILTER 5 = 90 SEC FILTER 6 = 300 SEC FILTER 7 = ADPTIVE FILTER
165	NO2 Filter enabled	0 = Disabled, 1 = Enabled
166	Background Interval	0 = 24 Hrs 1 = 12 Hrs 2 = 8 Hrs 3 = 6 Hrs 4 = 4 Hrs 5 = 2 Hrs 6 = Disable
167	Service (COM1) Baud	Serial baud rate
168	Multidrop (COM2) Baud	0 = 1200 bps 1 = 2400 bps 2 = 4800 bps 3 = 9600 bps 4 = 14400 bps 5 = 19200 bps 6 = 38400 bps
169	Service Protocol	0 = EC9800

170	Multidrop Protocol	1 = Bayern-Hessen 2 = Advanced 3 = Modbus
171	AO1 Over Range	The Upper Concentration Range when Over-Ranging is enabled
172	AO2 Over Range	
173	AO3 Over Range	
174	AO1 Over-Ranging	0 = Over Ranging Disabled
175	AO2 Over-Ranging	1 = Over Ranging Enabled
176	AO3 Over-Ranging	2 = Over Ranging enabled and currently active
177	Heater Set Point	Cell Heater Set Point units in °C
178	PMT High Volt. Pot	High voltage pot setting
179	PMT Test LED Pot	PMT Test LED intensity controller POT
180	Last Power Failure	Time Stamp of the Last power fail (4 byte time stamp) Bit 31:26 ---- Year (0 – 99) Bit 25:22 ---- Month (1 – 12) Bit 21:17 ---- Date (1 – 31) Bit 16:12 ---- Hour (00 – 23) Bit 11:06 ---- Min (00 – 59) Bit 05:00 ---- Sec (00 – 59)
181	Inst Manifld Pres.	Manifold Pressure in S40 instruments (instantaneous)
182	Cell Press. (gas5)	Cell Pressure for Gas 5 (Nx)
183	Gas 4 Inst.	Calculated gas concentration currently displayed on front screen E.g. NH3
184	Gas 4 Avg.	Average of the readings (for Gas 4) of the last n minutes where n is the averaging period E.g. NH3
185	Gas 5 Inst.	Calculated gas concentration currently displayed on front screen E.g. Nx
186	NH3 Conv. Efficiency	
187	Cell/Lamp Duty Cycle	
188	Mirror T. Duty Cycle	
189	Flow Temp Duty Cycle	
190	Cooler T. Duty Cycle	
191	Conv Temp Duty Cycle	
192	CO Conv T Duty Cycle	
193	F/Scale Curr AO 1	20 mA Calibration value
194	F/Scale Curr AO 2	
195	F/Scale Curr AO 3	

196	Z Adj Curr AO 1	4 mA Calibration value
197	Z Adj Curr AO 2	
198	Z Adj Curr AO 3	
199	Ext Analog Input 1	The value of the external analog input after the multiplier and offset have been applied
200	Ext Analog Input 2	
201	Ext Analog Input 3	
202	Conv Set Point	Converter Set Point
203	Cal. Pressure 3	Calibration Pressure 3
204	PTF Correction (gas 3)	Pressure Temperature Flow Compensation Factor for third gas in multi-gas instruments.
205	Dilution Ratio	The current dilution ratio (default is 1.0)
206	Traffic Light	State of the status light: 0 = Green 1 = Amber 2 = Off (normally impossible) 3 = Red
207	Network Protocol	0 = EC9800 1 = Bayern-Hessen 2 = Advanced 3 = Modbus
208	Gas 4 Offset	A offset applied to Gas 4
209	O3 GEN Fine Pot	Ozone generator control, DAC controlled. DAC: 0..64535
210	O3 Gen Lamp Current	Units in mA
211	O3 GEN Coarse Pot	Repeat of parameter 209
212	Logging Period	The data logging period, in seconds (1.. 86400)
213	O3 Gen Coeff A	Ozone generator coefficients Note that Coeff D is parameter 127
214	O3 Gen Coeff B	
215	O3 Gen Coeff C	
216	Meas. Count	S60 measure count
217	Sig. Count 1	S60 signal counts in 90° steps
218	Sig. Count 2	
219	Sig. Count 3	
220	Sig. Count 4	
221	Signal Voltage	S60 Signal voltage
222	LED Drive	S60 LED drive value

This page is intentionally blank.

Appendix B. EC9800 Protocol

The Serinus implements a subset of the 9800 instrument protocol. Only the basic commands of reading the concentration value and setting the instrument calibration state (measure, span or zero) are supported.

B.1 Command Format

All commands are sent as ASCII strings. Fields are delimited by commas and the command ends with the normal return key (i.e. the TERMINATOR is either a <CR> or a <LF>). The DEVICE I.D. is the Serial ID assigned in the **Main Menu → Communications Menu → Serial Communication Menu**. If the instrument is not being used in a multi-drop connection, the DEVICE I.D. can be replaced with the string “???”.

B.2 Commands

B.2.1 DCONC

Function: Sends the current instantaneous concentration data to the serial port.
Format: DCONC, {<DEVICE I.D.>} {TERMINATOR}
Device response: {GAS} <SPACE> {STATUS WORD} <CR><LF>

The GAS value is the concentration value in the current instrument units, expressed as a floating point number (i.e. 12.345). The STATUS WORD indicates the instrument status in hex (i.e. A01F) using the following format:

Bit 15 = SYSFAIL (MSB)
Bit 14 = FLOWFAIL
Bit 13 = LAMPFAIL
Bit 12 = CHOPFAIL
Bit 11 = CVFAIL
Bit 10 = COOLERFAIL
Bit 9 = HEATERFAIL
Bit 8 = REFFAIL
Bit 7 = PS-FAIL
Bit 6 = HV-FAIL
Bit 5 = OUT OF SERVICE
Bit 4 = Instrument is in zero mode
Bit 3 = Instrument is in span mode
Bit 2 = Unused
Bit 1 = SET→PPM selected, CLEAR→MG/M3
Bit 0 = reserved (LSB)

B.2.2 DSPAN

Function: Commands the instrument to enter span mode.
Format: DSPAN, {<DEVICE I.D.>} {TERMINATOR}

Device response: <ACK> if the instrument is able to perform the command, <NAK> if not.

B.2.3 DZERO

Function: Commands the instrument to enter the zero mode.

Format: DZERO, {<DEVICE I.D.>} {TERMINATOR}

Device response: <ACK> if the instrument is able to perform the command, <NAK> if not.

B.2.4 ABORT

Function: Commands the instrument to abort the current span/zero mode and return to measure mode.

Format: ABORT, {<DEVICE I.D.>} {TERMINATOR}

Device response: <ACK> if the instrument is able to perform the command, <NAK> if not.

B.2.5 RESET

Function: Reboots the instrument (software reset).

Format: RESET, {<DEVICE I.D.>} {TERMINATOR}

Device response: <ACK>.

Appendix C. Bayern-Hessen Protocol

The Serinus implements a limited subset of the Bayern-Hessen Network protocol. Only the ability to set the instrument calibration state (measure, span or zero) and read the gas concentrations are supported.

C.1 Command Format

<STX><text><ETX>< bcc1><bcc2>

Where:

- <STX> ASCII Start of Text = 0x02 hex.
- <Text> ASCII text maximum length of 160 characters.
- <ETX> ASCII End of Text = 0x03 hex.
- <bcc1> ASCII representation of block check value MSB. (That is, the character “3” for 3, the character “F” for 15, etc.)
- <bcc2> ASCII representation of block check value LSB.

The block check algorithm begins with 0 and exclusive-OR’s each ASCII character from <STX> to <ETX> inclusive. This block check value is converted to ASCII format and sent after the <ETX> character.

Examples

This is an example of a valid Bayern-Hessen data request for an instrument that has a Serial ID of 97 (Serial ID assigned in the **Main Menu → Communications Menu → Serial Communication Menu**):

<STX>DA097<EXT>3A

The block check calculation is best shown by the following example:

Table 20 – Bayern-Hessen Data

Character	Hex Value	Binary	Block Check
<STX>	02	0000 0010	0000 0010
D	44	0100 0100	0100 0110
A	41	0100 0001	0000 0111
0	30	0011 0000	0011 0111
9	39	0011 1001	0000 1110
7	37	0011 0111	0011 1001
<ETX>	03	0000 0011	0011 1010

The binary value 0011 1010 corresponds to the hex value 3A. This value in ASCII forms the last two characters of the data request message.

Note: The I.D. of 97 is sent as the sequence 097. All I.D. strings must have three digits and must always be padded with ASCII zero characters.

This is an example of a valid command to put the unit in the manual span mode if the instrument has an ID of 843:

```
<STX>ST843 K<ETX>52
```

The block check operation is best shown with the following table:

Table 21 – Block Check Operation

Character	Hex Value	Binary	Block Check
<STX>	02	0000 0010	0000 0010
S	53	0101 0011	0101 0001
T	54	0101 0100	0000 0101
8	38	0011 1000	0011 1101
4	34	0011 0100	0000 1001
3	33	0011 0011	0011 1010
<SPACE>	20	0010 0000	0001 1010
K	4B	0100 1011	0101 0001
<ETX>	03	0000 0011	0101 0010

The binary block check value is 0101 0010 which is the hex value 52 as shown at the end of the command string.

C.2 Commands

C.2.1 DA

Return the current instantaneous concentration.

Command Format

```
<STX>{DA}{<kkk>}<ETX>< bcc1><bcc2>
```

Where:

kkk Device's ID. This field is optional, but if provided it must be padded with zeros to be 3 characters long. The value must match one of the following: the instrument's Bayern-Hessen ID, 000, or ??? (three question marks).

bcc1 First byte of the block check calculation.
 bcc2 Second byte of the block check calculation.

Device response

The instrument responds with a variable length string, depending on how many measured gasses have been assigned an ID above 0. The text between the [] will be repeated once for each reported gas.

```
<STX>{MD}{cc} [<SP><kkk><SP><+nnnn+ee><SP><ss><SP><ff><SP><mmm><SP>eeeeee<SP>] <ETC><bcc1><bcc2>
```

Where:

<SP> Space (0x20 hex).
 cc The number of gasses reported (0..5). The text in between the [] will be repeated once for each gas reported.
 kkk The Bayern-Hessen instrument ID.
 +nnnn+ee Gas concentration.
 ss Status byte (see table below for individual bits).
 ff Failure byte (see table below for individual bits).
 mmm Gas ID.
 eeeeee Ecotech instrument ID.
 bcc1 First byte of the block check calculation.
 bcc2 Second byte of the block check calculation.

Table 22 – Status Bit Map

Status Bit	Meaning if set to 1
0	Instrument off (this value is always set to 0).
1	Out of service.
2	Zero mode.
3	Span mode.
4	-
5	-
6	Units: 1 = Volumetric, 0 = Gravimetric.
7	Background mode (S30 and S50 family only).

Table 23 – Failure Bit Map (Positive Logic)

Failure Bit	Meaning if set to 1
0	Flow sensor failure.
1	Instrument failure. Note that while the In Maintenance mode reports as an instrument failure with a red light on the front panel, for Bayern-Hessen this particular error is merely a status instead of a failure.
2	-
3	Lamp failure (S40 family only).
4	-
5	Cell heater failure (S30, S40 and S50 family only).
6	-
7	-

C.2.2 ST

Set the instrument mode.

Command Format

<STX>{ST}{< kkk>}<SP>{command}<ETC><bcc1><bcc2>

Where:

- kkk Device’s Serial ID. This field is optional, but if provided it must be padded with zeros to be 3 characters long. The value must match one of the following: the instrument’s Bayern-Hessen ID, 000, or ??? (three question marks).
- Command M, N or K for Measure, Zero or Span mode.
- bcc1 First byte of the block check calculation.
- bcc2 Second byte of the block check calculation.

Device response

The device does not issue a response to this command.

Appendix D. ModBus Protocol

The Serinus supports a limited Modbus implementation. The only function codes supported are 3 (read holding register) and 16 (write multiple registers). The Serial ID is assigned in the **Main Menu** → **Communications Menu** → **Serial Communication Menu**.

D.1 Command Format

<Slave address><Function code><Start register (MSB)><Start register (LSB)><Register count (MSB)><Register count (LSB)><Write byte count><Write data><CRC (MSB)><CRC (LSB)>

Where:

Slave address	The instrument Serial ID. If the request is being made via TCP, this field is omitted.
Function code	3 (read) or 16 (write).
Start register	Specifies an Advanced Protocol IEEE index (refer to Table 19 to see what values are available and what index to specify for them). The ModBus index is calculated from the Advanced Protocol index via the following formula: $\text{Modbus Index} = \text{Advanced Protocol Parameter List number} \times 2 + 256$
Register count	A single read command may request from 2 to 124 registers, which is to say from 1 to 62 values. The first index is specified by Start register; all following indexes are in sequential order. To read values that are not sequential requires using another read command. Note that the number of registers must be even, as each value is returned as a floating point value (4 bytes) and each register is a word (2 bytes). A write command can only write a single IEEE value at a time. Thus for write commands this value must be 2.
Write byte count	This field is only supplied for a write request; it indicates the amount of bytes of data that will follow, and must be set to 4 (since only one value can be written at a time).
Write data	This field is only supplied for a write request. It is the value to be written, expressed in IEEE format. The “Endian” structure can be selected on the Modbus Serial Communications menu. Big Endian means that the MSB byte of the IEEE value is at the right end of the four bytes; Little Endian means it is at the left.
CRC	Calculated by the standard Modbus CRC method. If the request is being made via TCP, this field is omitted.

D.2 Commands

D.2.1 Read Holding Registers

The response to a read request is in the following format:

<Slave address>3<Register count (MSB)><Register count (LSB)><Data><CRC (MSB)><CRC (LSB)>

Where:

Slave address	As general command format.
Register count	As general command format.
Data	4 to 248 bytes of data, representing 1 to 62 floating point numbers in IEEE format. The “Endian” structure can be selected on the Modbus Serial Communications menu. Big Endian means that the MSB byte of the IEEE value is at the right end of the four bytes; Little Endian means it is at the left.
CRC	As general command format.

D.2.2 Write Holding Register

The only supported use for this command is to set the instrument into a calibration state.

Where:

Start register MSB	1
Start register LSB	170
Register count	2
Write Data bytes	The IEEE representation of 0, 1, 2, or 3 0 puts the instrument into Measure mode (0,0,0,0) 1 puts the instrument into Cycle mode (63,128,0,0) 2 puts the instrument into Zero mode (64,0,0,0) 3 puts the instrument into Span mode (64,64,0,0)

The response to a write request is to return the first six bytes of the initiating write request.

D.2.3 Error

An error will be returned in the following format:

<Slave address><Function code><Exception code><CRC (MSB)><CRC (LSB)>

Slave address	As general command format.
Function code	The initiating command’s function code + 128; so either 131 (read) or 144 (write).

Exception code The error code (see table below).
CRC As general command format.

Table 24 – Modbus Error Codes

Value	Error
1	Illegal Function
2	Illegal Data Address
3	Illegal Data Value
4	Slave Device Failure



POWERED BY ACOEM

metone.com

User manual subject to change without notice. Images used are for illustrative purposes only.
All trademarks and registered trademarks are the property of their respective owners.
© 2022 Acoem and all related entities. All rights reserved.