

USER MANUAL

# GAS-1060

Direct Nitrogen Dioxide Analyzer  
US EPA Designated Equivalent Method

Version 3.0



POWERED BY ACOEM

[metone.com](http://metone.com)



POWERED BY ACOEM

Met One Instruments is now part of the Acoem Group. The Met One range of gas analyzers was originally developed by Acoem under the brand name Ecotech Serinus®.

For the purposes of expediting the availability of Met One gas analyzers to Met One customers around the world; Met One Instruments have chosen to use the original Ecotech Serinus® operating manual.

Although the name of the Met One instrument is different, the analyzer itself has remained unchanged and meets the strictest quality and performance requirements expected of Met One equipment. All the information presented in this manual is current, including analyzer specifications and operating principles.

Met One will update this manual to reflect the new branding convention in due course.

# Table of Contents

Manufacturer’s Statement .....	11
Notice .....	11
Safety Requirements .....	12
Warranty.....	12
Service & Repairs .....	13
CE Mark Declaration of Conformity .....	14
Claims for Damaged Shipments and Shipping Discrepancies .....	15
Internationally Recognised Symbols on Ecotech Equipment .....	16
Manual Revision History .....	17
<b>1. Introduction.....</b>	<b>19</b>
1.1 Description .....	19
1.2 Specifications .....	19
1.2.1 Measurement .....	19
1.2.2 Precision/Accuracy .....	19
1.2.3 Calibration .....	20
1.2.4 Power .....	20
1.2.5 Operating Conditions.....	20
1.2.6 Communications.....	20
1.2.7 Physical Dimensions.....	21
1.3 Nomenclature .....	21
1.4 Background/Theory.....	22
1.4.1 Measurement Theory.....	23
1.5 Instrument Description .....	24
1.5.1 Calibration Valve Manifold .....	24
1.5.2 Background Scrubber DAU .....	24
1.5.3 Sample Filter Holder .....	24
1.5.4 Sample DFU .....	25
1.5.5 Dryer .....	25
1.5.6 Pressure Sensor PCA .....	25
1.5.7 Interface PCA .....	25
1.5.8 Measurement Cell Assembly .....	25
1.5.9 Pneumatic Tubing .....	26
1.5.10 Main Controller PCA .....	26
1.5.11 Power Supply .....	26
1.5.12 On/Off Switch .....	26
1.5.13 Communications.....	27
<b>2. Installation.....</b>	<b>29</b>
2.1 Initial Check .....	29
2.2 Installation Notes .....	30
2.3 Instrument Set-Up.....	31
2.3.1 Pneumatic Connections .....	31
2.3.2 Power Connections.....	32
2.3.3 Communications Connections .....	32

2.3.4	Instrument Set-Up.....	33
2.4	Transporting/Storage.....	33
<b>3.</b>	<b>Operation.....</b>	<b>37</b>
3.1	Warm-Up.....	37
3.2	Measurement.....	37
3.3	General Operation Information.....	37
3.3.1	Keypad & Display.....	37
3.3.2	Home Screen.....	39
3.4	Menus & Screens.....	40
3.4.1	Quick Menu.....	41
3.4.2	Main Menu.....	41
3.4.3	Analyser State Menu.....	42
3.4.4	Status Menu.....	42
3.4.5	Temperature Menu.....	43
3.4.6	Pressure & Flow Menu.....	44
3.4.7	Voltage Menu.....	44
3.4.8	General Settings Menu.....	44
3.4.9	Measurement Settings Menu.....	45
3.4.10	Calibration Menu.....	46
3.4.11	Pressure Calibration Menu.....	48
3.4.12	Service Menu.....	48
3.4.13	Diagnostics Menu.....	49
3.4.14	Digital Pots Menu.....	49
3.4.15	Internal Pump Menu (Option).....	50
3.4.16	Valve Menu.....	50
3.4.17	Tests Menu.....	51
3.4.18	Digital Input Test Menu.....	51
3.4.19	Digital Output Test Menu.....	52
3.4.20	Calculation Factors Menu.....	52
3.4.21	Communications Menu.....	53
3.4.22	Data Logging Menu.....	53
3.4.23	Serial Communication Menu.....	53
3.4.24	Analog Input Menu.....	54
3.4.25	Analog Output Menu.....	54
3.4.26	Digital Input Menu.....	56
3.4.27	Digital Output Menu.....	56
3.4.28	Network Menu.....	57
3.4.29	Bluetooth Menu.....	58
3.4.30	Advanced Menu.....	59
3.4.31	Hardware Menu.....	59
3.4.32	Parameter Display Menu.....	60
<b>4.</b>	<b>Communications.....</b>	<b>61</b>
4.1	RS232 Communication.....	61
4.2	USB Communication.....	62
4.3	TCP/IP Network Communication (optional).....	63
4.3.1	Network Setup.....	64
4.3.2	Port Forwarding on Remote Modem/Router Setup.....	64
4.3.3	Setup Airodis to Communicate with Serinus.....	65
4.4	Digital/Analog Communication.....	66

4.4.1	Analog Outputs .....	66
4.4.2	Analog Inputs .....	68
4.4.3	Digital Status Inputs .....	68
4.4.4	Digital Status Outputs .....	68
4.5	Logging Data .....	69
4.5.1	Configure Instrument Internal Logging .....	69
4.6	Using Airodis Software to Download Data .....	70
4.6.1	Connecting the Instrument to Your PC .....	70
4.6.2	Installing Airodis .....	73
4.6.3	Configuring Airodis .....	73
4.7	Serinus Remote App/Bluetooth .....	79
4.7.1	Installation .....	79
4.7.2	Connecting to the Instrument .....	80
4.7.3	Instrument Control .....	81
4.7.4	Real-Time Plot.....	82
4.7.5	Download.....	84
4.7.6	Get Parameters.....	84
4.7.7	Preferences.....	85
<b>5.</b>	<b>Calibration .....</b>	<b>87</b>
5.1	Overview .....	87
5.2	Pressure Calibration .....	89
5.2.1	Full Pressure Calibration .....	89
5.2.2	Ambient Point Pressure Calibration.....	90
5.3	Pressure Calibration (Internal Pump Option Only).....	91
5.4	Zero Calibration.....	91
5.4.1	Calibration Port.....	92
5.4.2	Sample Port .....	92
5.4.3	Internal Zero (Sample Port) .....	93
5.5	Span Calibration .....	93
5.5.1	Calibration Port.....	93
5.5.2	Sample Port .....	94
5.5.3	Manual Instrument Gain and Offset Adjustments.....	94
5.6	Precision Check .....	95
5.7	Multipoint Precision Check .....	95
5.8	High Pressure Zero/Span Valve .....	97
5.8.1	Single Pressurised Calibration Option.....	98
5.8.2	Dual Pressurised Calibration Option.....	100
<b>6.</b>	<b>Service .....</b>	<b>103</b>
6.1	Maintenance Tools.....	103
6.2	Maintenance Schedule .....	104
6.3	Maintenance Procedures .....	106
6.3.1	Background Scrubber DAU check .....	106
6.3.2	Particulate Filter Replacement .....	107
6.3.3	Clean Fan Filter .....	107
6.3.4	Sample DFU Replacement .....	108
6.3.5	Background Scrubber DAU Replacement .....	108
6.3.6	Leak Check .....	109

6.3.7	Clean Pneumatics .....	111
6.3.8	Pressure Sensor Check .....	111
6.4	Bootloader .....	113
6.4.1	Display Help Screen .....	113
6.4.2	Communications Port Test .....	113
6.4.3	Updating Firmware .....	114
6.4.4	Erase All Settings .....	114
6.4.5	Start Analyser .....	114
<b>7.</b>	<b>Troubleshooting.....</b>	<b>115</b>
7.1	Leak Check .....	117
7.2	Flow Fault .....	118
7.3	Noisy/Unstable Readings .....	119
7.4	Flow Block Temperature Failure .....	120
7.5	Measurement Cell Temperature Failure.....	121
7.6	USB Memory Stick Failure.....	122
7.7	Ecotech Service Support Files .....	123
<b>8.</b>	<b>Optional Extras.....</b>	<b>125</b>
8.1	Dual Sample Filter (PN: E020100) .....	125
8.2	Internal Pump (PN: E020124) .....	125
8.2.1	Hardware Setup .....	125
8.2.2	Pressure Calibration .....	126
8.2.3	Pump control.....	126
8.3	Rack Mount Kit (PN: E020116).....	126
8.4	High Pressure Zero/Span Valves .....	130
<b>9.</b>	<b>Parts List.....</b>	<b>131</b>
9.1	Serinus Accessories Kit.....	131
9.2	Maintenance Kit.....	131
9.3	Consumables .....	132
9.4	Instrument Parts List.....	132
9.5	Plumbing Schematic – (PN: D020060) .....	134
9.6	Block Wiring Schematic – (PN: D020111) .....	135
9.7	Measurement Cell Side Section – (PN: H015000) .....	136
9.8	Calibration Valve Manifold Assembly Exploded View – (PN: H010013-01) .....	138
9.9	Valve Assembly Exploded View – (PN: H010042) .....	139
9.10	High Pressure Valve Exploded View – (PN: H050043) .....	140

## List of Figures

Figure 1 – Simple Pneumatic Diagram.....	23
Figure 2 – Internal Components Diagram .....	24
Figure 3 – Ecotech Tygon Tubing .....	26
Figure 4 – Opening the Instrument .....	29

Figure 5 – Instrument Back Panel .....	31
Figure 6 – Installation of USB Memory Stick .....	34
Figure 7 – Switching the Battery On/Off .....	35
Figure 8 – Front Panel .....	38
Figure 9 – Home Screen .....	39
Figure 10 – Communication Ports .....	61
Figure 11 – Multidrop RS232 Cable Example .....	62
Figure 12 – Example of Typical Network Setups .....	63
Figure 13 – Example of Network Menu Setup .....	64
Figure 14 – Port Forwarding Example .....	65
Figure 15 – LAN Network Set-Up (Airodis) .....	65
Figure 16 – WAN Network Set-Up (Airodis) .....	66
Figure 17 – 25 Pin Rear Panel PCA (Default Jumpers Highlighted) .....	68
Figure 18 – External 25 pin I/O Individual Pin Descriptions .....	69
Figure 19 – Installing Driver Software (Device Manager) .....	70
Figure 20 – Update Driver Popup .....	71
Figure 21 – Update Driver Popup (Directory Location) .....	71
Figure 22 – Installing Driver Confirmation Prompt .....	72
Figure 23 – Successful Driver Installation .....	72
Figure 24 – Airodis Workspace Manager .....	74
Figure 25 – Adding a New Station .....	74
Figure 26 – New Station Connection .....	75
Figure 27 – Station Configuration .....	76
Figure 28 – Error Status Notification .....	76
Figure 29 – Downloading Data .....	77
Figure 30 – Download Data Status .....	77
Figure 31 – Data Visibility .....	78
Figure 32 – Exporting Data .....	78
Figure 33 – Data Download Complete .....	79
Figure 34 – Downloading the App from Google Play Store .....	80
Figure 35 – Bluetooth Pairing Request .....	80
Figure 36 – Showing or Hiding the NumPad .....	81
Figure 37 – Switching Analysers .....	82
Figure 38 – Real-Time Plot .....	83
Figure 39 – Plot of Downloaded Data .....	84
Figure 40 – Directory Settings .....	85
Figure 41 – Logs Format .....	85
Figure 42 – Colour Theme Settings .....	86
Figure 43 – Example of a Calibration System .....	87
Figure 44 – Setting the Ambient Set Point .....	90
Figure 45 – Multipoint Calibration Results Example .....	97
Figure 46 – Single High Pressure Calibration Option .....	98
Figure 47 – Dual High Pressure Calibration Option .....	100

Figure 48 – Minifit Extraction Tool – (T030001).....	103
Figure 49 – Orifice/Sintered Filter Removal Tool – (H010046) .....	103
Figure 50 – Leak Test Jig – (H050069) .....	104
Figure 51 – Air Monitoring Test Equipment Kit (AMTEK) – Customisable .....	104
Figure 52 – Removing the Plunger .....	107
Figure 53 – Removing the Fan Filter.....	108
Figure 54 – Sample DFU.....	108
Figure 55 – Background DAU.....	109
Figure 56 – Test Point Location .....	112
Figure 57 – Typical Test Point Reading of Internal Pump Pressure Sensor .....	112
Figure 58 – Typical Test Point Reading of Measurement Cell Pressure Sensor .....	113
Figure 59 – Leak Check Troubleshooting Flow Chart .....	117
Figure 60 – Zero Flow Fault Troubleshooting Flow Chart .....	118
Figure 61 – Noisy or Unstable Readings Troubleshooting Flow Chart .....	119
Figure 62 – Flow Block Temp failure Troubleshooting Flow Chart.....	120
Figure 63 – Measurement Cell Temperature Failure Troubleshooting Flow Chart .....	121
Figure 64 – USB Memory Stick Failure .....	122
Figure 65 – USB Memory Stick File Structure.....	124
Figure 66 – Dual Filter Option Installed.....	125
Figure 67 – Separate Rack Slides .....	127
Figure 68 – Assemble Inner Slide on Chassis.....	127
Figure 69 – Rack Mount Ears Fitted to Instrument .....	128
Figure 70 – Attach Rack Mount Adaptors to Outer Slides.....	128
Figure 71 – Test Fit the Rack Slide Assembly into Your Rack .....	129
Figure 72 – Attach Slides to Front of Rack.....	129
Figure 73 – Slide Clips.....	130



## List of Tables

Table 1 – Manual Revision History .....	17
Table 2 – Measurements Times .....	37
Table 3 – Digital Output States .....	57
Table 4 – Analog Outputs .....	66
Table 5 – New Station Setup .....	75
Table 6 – Maintenance Schedule .....	104
Table 7 – Troubleshoot List .....	115
Table 8 – Included Parts (Rack Mount Kit) .....	126
Table 9 – Serinus Accessories Kit (PN: H010136) .....	131
Table 10 – Annual Maintenance Kit – (PN: E020203-01) .....	131
Table 11 – Consumables.....	132
Table 12 – Spare Parts List .....	132
Table 13 – Packet Format.....	141
Table 14 – Example: Primary Gas Request.....	141
Table 15 – Example: Primary Gas Response .....	142
Table 16 – Example: Primary Gas Response (continued).....	142
Table 17 – List of Errors.....	142
Table 18 – Example: Get IEEE Response data .....	143
Table 19 – Advanced Protocol Parameter List .....	144
Table 20 – Bayern-Hessen Data .....	157
Table 21 – Block Check Operation .....	158
Table 22 – Status Bit Map .....	159
Table 23 – Failure Bit Map (Positive Logic) .....	160
Table 24 – Modbus Error Codes .....	163

This page is intentionally blank.

## Manufacturer's Statement

Thank you for selecting the Ecotech Serinus 60 Nitrogen Dioxide Analyser.

The Serinus series is the next generation of Ecotech designed and manufactured gas analysers. The Serinus 60 will perform NO<sub>2</sub> measurements over a range of 0-1 ppm with a lower detectable limit of 0.04 ppb.

This User Manual provides a complete product description including operating instructions, calibration and maintenance requirements for the Serinus 60. Reference should also be made to the relevant local standards which should be used in conjunction with this manual. Some of these standards are listed in this manual.

If, after reading this manual you have any questions or you are still unsure or unclear on any part of the Serinus 60, please do not hesitate to contact Ecotech or your local Ecotech distributor.



Please help the environment and recycle the pages of this manual when you have finished using it.

## Notice

The information contained in this manual is subject to change without notice. Ecotech reserves the right to make changes to equipment construction, design, specifications and /or procedures without notification.

Copyright © 2016. All rights reserved. Reproduction of this manual, in any form, is prohibited without the written consent of Ecotech Pty Ltd.



### CAUTION

Hazardous voltages exist within the instrument. Do not remove or modify any of the internal components or electrical connections whilst the mains power is on.

Ensure the mains power lead is maintained in a safe working condition.

The instruments lid should be closed during normal operation to comply with EMC regulations.

## Safety Requirements

To reduce the risk of personal injury caused by electrical shock, follow all safety notices and warnings in this documentation.

If the equipment is used for purposes not specified by Ecotech, the protection provided by this equipment may be impaired.

Replacement of any part should only be carried out by qualified personnel, using only parts specified by Ecotech as these parts meet stringent Ecotech quality assurance standards. Always disconnect the power source before removing or replacing any components.

## Warranty

This product has been manufactured in an ISO 9001/ISO 14001 facility with care and attention to quality.

The product is subject to a 24-month warranty on parts and labour from date of shipment. The warranty period commences when the product is shipped from the factory. Lamps, filters and other consumable items are not covered by this warranty.

Each instrument is subjected to a vigorous testing procedure prior to despatch and will be accompanied with a parameter list and a multipoint precision check, thereby enabling the instrument to be installed and ready for use without any further testing.

## Service & Repairs

Our qualified and experienced technicians are available to provide fast and friendly service between the hours of 8:30am – 5:00pm AEST Monday to Friday. Please contact either your local distributor or Ecotech regarding any questions you have about your instrument.

### Service Guidelines

This manual is designed to provide the necessary information for the setup, operation, testing, maintenance and troubleshooting of your instrument.

Should you still require support after consulting the documentation, we encourage you to contact your local distributor for support.

To contact Ecotech directly, please e-mail our Technical Support Services group at [support@ecotech.com](mailto:support@ecotech.com) or to speak with someone directly:

Please dial 1300 364 946 if calling from within Australia.

Please dial +61 3 9730 7800 if calling from outside of Australia.

Please contact Ecotech and obtain a Return Material Authorisation (RMA) number before sending any equipment back to the factory. This allows us to track and schedule service work and to expedite customer service. Please include this RMA number when you return equipment, preferably both inside and outside the shipping packaging. This will ensure you receive prompt service.

When shipping instrumentation, please also include the following information:

- Name and phone number
- Company name
- Shipping address
- Quantity of items being returned
- Model number/s or a description of each item
- Serial number/s of each item (if applicable)
- A description of the problem and any fault-finding completed
- Original sales order or invoice number related to the equipment

Shipping Address:

Attention Service Department

Ecotech Pty Ltd

1492 Ferntree Gully Road,

Knoxfield, VIC, Australia 3180.

## CE Mark Declaration of Conformity

This declaration applies to the Serinus 60 Nitrogen Dioxide Analyser as manufactured by Ecotech Pty. Ltd. of 1492 Ferntree Gully Rd, Knoxfield, VIC Australia 3180. The instrument to which this declaration relates is in conformity with the following European Union Directives:

### **Council Directive of 15 December 2004 on the approximation of the laws of Member States relating to electromagnetic compatibility (2004/108/EC)**

The following standard was applied:

EN 61326-1:2013            Electrical equipment for measurement, control and laboratory use – EMC requirements – Part 1: General requirements.

#### **Immunity Requirements EN 61326-1**

IEC-61000-4-2            Electrostatic discharge immunity  
IEC-61000-4-3            Radiated RF immunity  
IEC-61000-4-4            Electrical fast transient burst immunity  
IEC-61000-4-5            Surge immunity  
IEC-61000-4-6            Conducted RF immunity  
IEC-61000-4-11          Voltage dips and interruption immunity

#### **Electromagnetic Compatibility EN 61326-1**

CISPR-11                 Radiated RF emission measurements  
CISPR-11                 Mains terminal RF emission measurements  
IEC-61000-3-3            Mains terminal voltage fluctuation measurements  
IEC-61000-3-2            Power frequency harmonic measurements

### **Council Directive of 12 December 2006 on the harmonisation of the laws of Member States relating to electrical equipment designed for use within certain voltage limits (2006/95/EC)**

The following standard was applied:

EN 61010-1:2013          Safety requirements for electrical equipment, for measurement control and laboratory use (3<sup>rd</sup> edition) – Part 1: General requirements

For protection against:

- Electric shock or burn
- Mechanical Hazards
- Excessive temperature
- Spread of fire from the equipment
- Effects of fluids and fluid pressure
- Effects of radiation, including laser sources, sonic and ultrasonic pressure
- Liberated gases, explosion and implosion

## Claims for Damaged Shipments and Shipping Discrepancies

### Damaged Shipments

Inspect all instruments thoroughly on receipt. Check materials in the container/s against the enclosed packing list. If the contents are damaged and/or the instrument fails to operate properly, notify the carrier and Ecotech immediately.

The following documents are necessary to support claims:

- Original freight bill and bill of lading
- Original invoice or photocopy of original invoice
- Copy of packing list
- Photographs of damaged equipment and container

You may want to keep a copy of these documents for your records.

Please refer to the instrument name, model number, serial number, sales order number and your purchase order number on all claims.

You should also:

- Contact your freight forwarder for an insurance claim
- Retain packing material for insurance inspection

### Shipping Discrepancies

Check all packages against the packing list immediately on receipt. If a shortage or other discrepancy is found, notify the carrier and Ecotech immediately. Ecotech will not be responsible for shortages against the packing list unless they are reported within seven days.

### Contact Details

Head Office

1492 Ferntree Gully Road, Knoxfield, VIC Australia 3180

Phone: +61 (0)3 9730 7800 Fax: +61 (0)3 9730 7899





Email: [info@ecotech.com](mailto:info@ecotech.com)

Service: [service@ecotech.com](mailto:service@ecotech.com)

Support: [support@ecotech.com](mailto:support@ecotech.com)

[www.ecotech.com](http://www.ecotech.com)

## Internationally Recognised Symbols on Ecotech Equipment

	Protective conductor terminal	IEC 60417-5017
	Alternating current	IEC 60417-5032
	Caution, hot surface	IEC 60417-5041
	Caution, risk of danger. Refer to accompanying documents	ISO 7000-0434
	Caution, risk of electric shock	ISO 3864-5036



## Manual Revision History

Manual PN: M010060

Current revision: 3.0

Date released: 7 March 2016

Description: User Manual for the Serinus 60 Nitrogen Dioxide Analyser

This manual is the full user manual for the Serinus 60 Nitrogen Dioxide Analyser. This manual contains all relevant information on theory, specifications, installation, operation, maintenance and calibration. Any information that cannot be found within this manual can be obtained by contacting Ecotech.

This manual uses cross reference links extensively throughout this manual. The hot keys below will greatly reduce the amount of time scrolling between references:

- You can access the links by pressing the following:
  - > CTRL + LEFT MOUSE CLICK: Move to the link location
- You can switch between links by pressing the following:
  - > ALT + LEFT ARROW KEY: Returns you to previous Link
  - > ALT + RIGHT ARROW KEY: Swaps back

**Table 1 – Manual Revision History**

Edition	Date	Summary
3.0	March 2016	Initial release

This page is intentionally blank.

## 1. Introduction

---

### 1.1 Description

---

The Serinus 60 Nitrogen Dioxide Analyser (NO<sub>2</sub>) utilizes cavity attenuated phase shift spectroscopy detection to perform continuous analysis of nitrogen dioxide.

The Serinus 60 can measure to a sensitivity of 20 ppt with a range of 0-1 ppm. The measurement of this gas is performed with the following main sub-components:

Particulate filters  
Sample dryer  
Measurement cell (temperature controlled)  
Light source (Blue LED) and Photo Detector  
Interface PCA

A microprocessor programmed with Serinus firmware monitors the detector response and many other parameters. The concentrations are automatically corrected for gas temperature and pressure changes and when using gravimetric units (e.g. µg/m<sup>3</sup>) is referenced to 0°C, 20°C or 25°C at 1 atmosphere. This allows the Serinus 60 to provide readings in the relevant units for your requirements. This section will describe the specifications of the instrument as well as the main components and techniques used to obtain stable gas concentration readings.

---

### 1.2 Specifications

---

#### 1.2.1 Measurement

##### Range

0-1 ppm autoranging

Lower detectable limit: 0.04 ppb, with no filter active

Noise: < 0.02 ppb

#### 1.2.2 Precision/Accuracy

##### Precision

0.04 ppb otherwise 0.5 % of reading, whichever is greater

##### Linearity

±4 % of full scale

##### Response Time

30 seconds

---

## Sample Flow Rate

0.5 slpm

### 1.2.3 Calibration

#### Zero Drift

Temperature dependant: 0.1 ppb per °C

24 hours: < 0.4 ppb

7 days: < 1.0 ppb

#### Span Drift

Temperature dependant: 0.1 % per °C

7 days: < 1.0 % of reading

### 1.2.4 Power

#### Operating voltage

100-240 VAC, 50 to 60 Hz (autoranging)

#### Power Consumption

88 VA max (typical at start up)

65 VA after warm up

### 1.2.5 Operating Conditions

#### Ambient Temperature Range

0 °C to 40 °C (32 °F to 104 °F)

#### Sample Pressure Dependence

5 % change in pressure produces less than a 1 % change in reading

Maximum altitude: 3000 m above sea level

### 1.2.6 Communications

#### Analog Output

- Menu selectable current output of 0-20 mA, 2-20 mA or 4-20 mA.
- Voltage output of 0 to 5 V, with menu selectable zero offset of 0 V, 0.25 V or 0.5 V.
- Voltage output of 0 to 10 V (configured using jumpers (JP3) on rear panel PCA).
- Range: 0 to full scale from 0-0.05 ppm to 0-1 ppm.

## Analog Input

- Three analog voltage inputs (0-5 VDC) CAT I rated.

## Digital Output

- RS232 port #1: Normal digital communication.
- RS232 port #2: Multidrop port used for multiple instrument connections on a single RS232.
- USB port connection on rear panel.
- TCP/IP port (optional)
- USB memory stick (front panel) for data logging, event logging, parameter and configuration storage.
- 25 pin connector with discrete status and user control.
  - o Eight Digital Outputs, open collector max 400 mA each @ 12 VDC (max total output 2 A).
  - o Eight Digital Inputs, 0-5 VDC, CAT I rated.

### 1.2.7 Physical Dimensions

#### Case Dimensions

Rack length (front to rear):	597 mm (23.5")
Total length (with latch release):	638 mm (25.1")
Chassis width:	418 mm (16.5")
Front panel width:	429 mm (16.9")
Chassis height:	163 mm/Uses 4RU (6.4")
Front panel height:	175 mm (6.9")
Weight:	19.4 kg

## 1.3 Nomenclature

NO <sub>2</sub> :	Nitrogen dioxide.
Span:	A gas sample of known composition and concentration used to calibrate/check the response of the instrument.
Zero:	Zero calibration uses zero air (NO <sub>2</sub> scrubbed ambient air) to calibrate/check the zero response of the instrument.
Extinction:	A measure of light scattering and absorption of NO <sub>2</sub> .
Background:	The value of the extinction measure without NO <sub>2</sub> present.
Multipoint Precision Check:	A procedure to verify the linearity of the response of the instrument.

Calibration:	The process of adjusting the instrument to ensure that it is measuring the correct concentration.
Zero Drift:	The change in the instruments response to zero air over a period of continuous unadjusted operation.
Zero Air:	Is purified air in which the concentration of NO <sub>2</sub> is <0.02 ppb with water vapour of less than 10 % RH. Sufficient purified air can be obtained by passing dry ambient air through an activated charcoal filter, a Purafil cartridge and a particulate filter.
External Span Source:	Span gas that is delivered via an external accredited cylinder containing NO in balance with N <sub>2</sub> (e.g. NATA/NIST).
Sample Air:	Sample air is defined as the sample before it has entered the reaction cell, as distinguished from the exhaust air.
Exhaust Air:	Exhaust air is the sample air after it has passed through the reaction/measurement/detection cell and is moving towards being expelled from the instrument.
ID and OD:	These are measurements of tubing, ID is the internal diameter of tubing and OD is the outer diameter.
Multidrop:	A configuration of multiple instruments connected via the same RS232 cable.
Bootloader:	A program that checks whether the current firmware is valid, executes the instrument start-up. The bootloader can be entered by pressing the '+' key on the front keypad during the first ½ second after power on and following the prompts. The bootloader enables various low level recovery tools, including updating the firmware from a USB memory stick.
PCA:	Printed Circuit Assembly. An electronic circuit mounted on a printed circuit board to perform a specific electronic function.
Slpm:	Standard litres per minute. This is the flow referenced to standard temperature and pressure conditions. For the purposes of this manual, all flows are referenced to 0 °C and 101.3 kpa (1 atm).

---

## 1.4 Background/Theory

---

Nitrogen dioxide (NO<sub>2</sub>) forms quickly from emissions of combustion engines, fossil fuelled power plants, bacterial action in soil, forest fires, volcanic action and lighting. At high levels NO<sub>2</sub> is a yellowish gas with a pungent odour. NO<sub>2</sub> is a major chemical pollutant in photochemical smog. NO<sub>2</sub> is linked with a number of adverse effects on the heart and respiratory system.

### 1.4.1 Measurement Theory

The measurement of nitrogen dioxide utilizes cavity attenuated phase shift spectroscopy (CAPS). Sample air is first drawn through a five micron filter then it is dried and filtered again by a ten nanometer filter to remove particulates before entering the precision stainless steel 264 mm measurement cell. After the sample is drawn through the cell and measured it is drawn through an orifice (controlling the system flow) and then sample is exhausted out of the instrument.

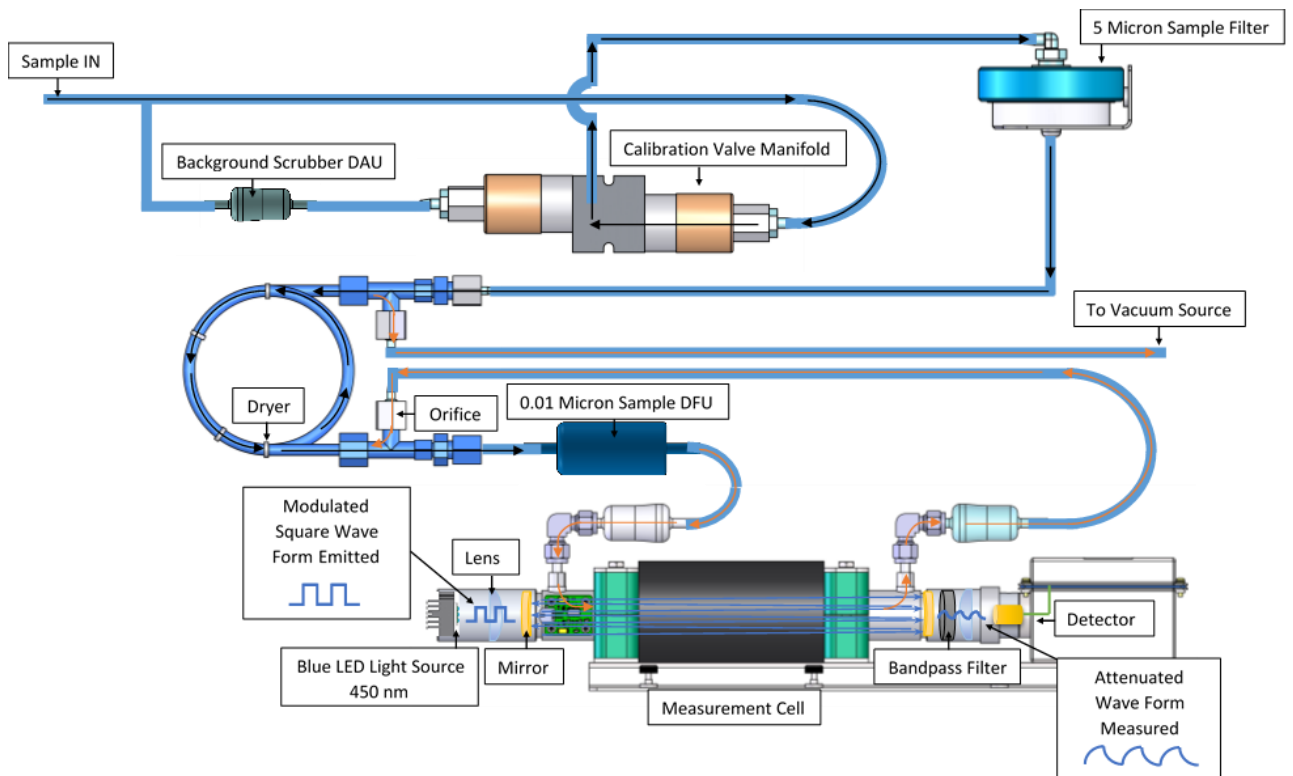

**Figure 1 – Simple Pneumatic Diagram**

The measurement cell contains two high reflectivity mirrors located at either end to provide an optical path length of approximately 2 km. A modulated light emitting diode (LED), with a narrow band wavelength of 450 nm, is used as a photon source for the cavity absorption process. The LED is pulsed into the optical cavity and the photon "leakage", as a result of the optical cavity, is determined through the output voltage of a vacuum photodiode detector.

The vacuum photodiode detector is used in conjunction with a narrow (10 nm wide) band-pass interference filter that is optimised to the absorption wavelength of the target compound, in this case the 450 nm absorption band of the NO<sub>2</sub> molecule.

During LED modulation the photon leakage of the cavity combined with photon absorption from gas molecules within the cavity produces a shift in the phase of the response signal measured by the vacuum photodiode detector.

By measuring the phase angle shift without NO<sub>2</sub> in the sample (background) a baseline phase shift can be measured. During operation, NO<sub>2</sub> gas molecules within the cavity will increase photon decay

and this will be reflected as a change in phase of the vacuum photodiode detector signal. This change in phase of the vacuum photodiode detector signal is a measure of NO<sub>2</sub> concentration.

Using this principle it is possible to reliably measure NO<sub>2</sub> concentrations of well under 1 ppb and up to 1000 ppb. Due to the continuous measure of the sample stream the Serinus 60 NO<sub>2</sub> analyser has a fast response time of less than 30 seconds.

---

## 1.5 Instrument Description

---

The major components of the Serinus 60 are described below:

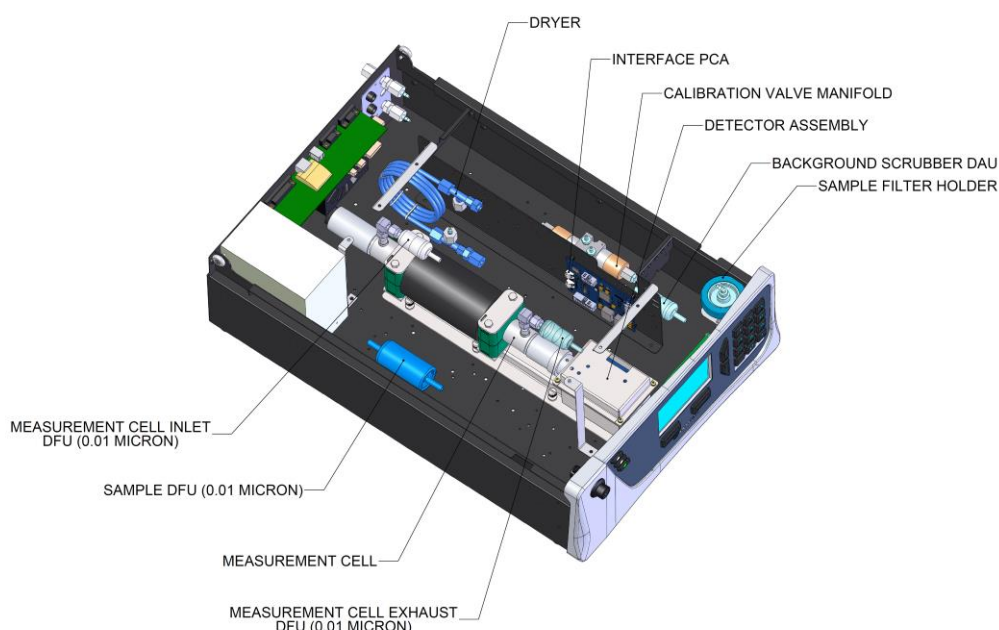

**Figure 2 – Internal Components Diagram**

### 1.5.1 Calibration Valve Manifold

The calibration valve manifold switches between sample, calibration and background gas.

### 1.5.2 Background Scrubber DAU

The background scrubber disposable absorbent unit (DAU) is a replaceable activated carbon scrubber used to remove NO<sub>2</sub> from the sample stream during an automatic or manual background measurement. It is also utilised during and internal zero calibration mode.

### 1.5.3 Sample Filter Holder

Within the sample filter holder is a particulate filter. The particulate filter is a Teflon 5 micron (µm) filter with a diameter of 47mm. This filter eliminates all particles larger than 5µm that could interfere with sample measurement. The 5 micron filter element should be replaced on a regular basis.



#### 1.5.4 Sample DFU

The sample disposable filter unit (DFU) is a very fine filter used to remove particulates down to 0.01 micron from the sample as absorption from particulates is the main interferent to this measurement method.

#### 1.5.5 Dryer

The dryer is constructed of Nafion tubing and is designed to remove water vapour from the sample drawn in to the measurement cell. The water is absorbed and moves through the walls of the tubing, evaporating into the surrounding air. The remaining gas is unaffected. The flow control is performed by utilising a critical orifice between the measurement cell outlet and the gas dryer's dry purge gas inlet. This creates a pressure differential between the dryer's polymer tube increasing efficiency.

#### 1.5.6 Pressure Sensor PCA

An absolute-pressure transducer is mounted on the measurement cell and used to measure the sample pressure in the cell. This pressure is used to check for flow and correct readings for pressure variations.

#### 1.5.7 Interface PCA

Provides complex timing signals to the LED light source, and splits the frequency signal from the Mixer Preamp PCA into the 4 separate phases for the Main Controller PCA.

Various power supplies and LED light source adjustments are also controlled on this PCA.

#### 1.5.8 Measurement Cell Assembly

##### **Measurement Cell**

The measurement cell consists of an optical source, two focusing lenses, mirrors, optical 450nm bandpass filter in a stainless steel cell 30cm long. Internally two very highly reflective mirrors create a very long optical path length. The cell is temperature controlled to improve its stability. The optical source utilizes a blue light emitting diode (LED) to provide a direct absorption measurement of nitrogen dioxide at 450 nm using phase shift measurement technique.

##### **Measurement Cell Inlet DFU**

This is a disposable filter unit (DFU), it is a very fine filter used to protect the measurement cell from particulates down to 0.01 micron. Located on the inlet of the measurement cell.

##### **Measurement Cell Exhaust DFU**

This is a disposable filter unit (DFU), it is a very fine filter used to protect the measurement cell from particulates down to 0.01 micron. Located on the exhaust of the measurement cell.

##### **LED Light Source**

Consists of a single surface mount blue LED mounted on a heat sink to dissipate the heat.

## Mixer Preamp PCA

Amplifies the optical signal received by the vacuum photodiode detector. The resulting signal is converted to a frequency and transmitted to the Interface PCA.

### 1.5.9 Pneumatic Tubing

The pneumatic tubing inside this instrument is specially designed for use in Ecotech Serinus instruments. It has the flexibility of Tygon tubing with the added inner sheath of Teflon to prevent contamination of the sample. Care should be taken when removing and inserting the tubing into the barbed fittings.

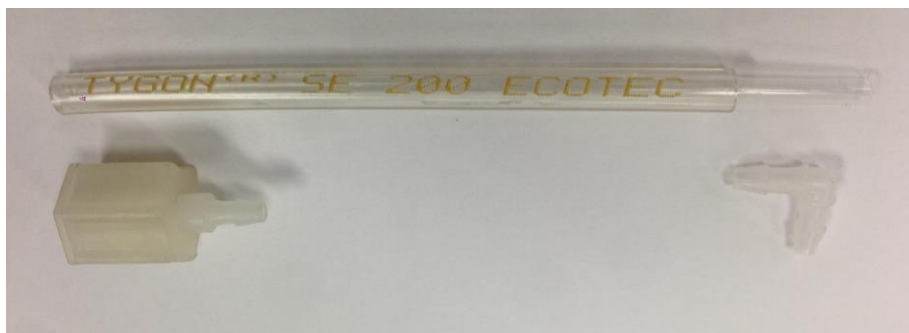

Figure 3 – Ecotech Tygon Tubing

### 1.5.10 Main Controller PCA

The main controller PCA controls all the processes within the instrument. As well as the on-board microprocessor, it contains a battery backed clock, calendar, analog to digital converters and many other circuits for signal processing and control. The ambient pressure and chassis temperature sensors are also located on this board. The main controller PCA is located above all other components within the instrument. It pivots on hinges to allow access to the components underneath.



#### CAUTION

Never place objects on top of the main controller PCA as it may result in damage.

### 1.5.11 Power Supply

The power supply is a self-contained unit housed in a steel case designed to meet all the relevant safety and EMC requirements. This new revision of power supply is different to the previous revision as there is no need to set the operating voltage switch because it is autoranging.

The output of the power supply provides +12V, +5V, -12V and +3.3V to the instrument.

### 1.5.12 On/Off Switch

The on/off switch is located on the back panel (bottom right facing the rear of the instrument). It is part of the power supply.

### 1.5.13 Communications

Communication between the instrument and either a data logger, laptop or network can be performed with the following communication connections located on the back panel (refer to Figure 5). These connections can be used for downloading data, onsite diagnostics, maintenance and firmware upgrades.

#### **RS232 #1**

This port is designed to be used for simple RS232 communication.

#### **RS232 #2**

This port is designed to be used for simple RS232 communication or in multidrop configuration.

#### **USB**

This port can be used for instrument communications with equipment through a standard USB port.

#### **TCP/IP (optional)**

This port is best used for remote access and real-time access to instruments when a network is available to connect with.

#### **External I/O Port**

The analog/digital port sends and receives analog/digital signals to other devices. These signals are commonly used to activate gas calibrators or for warning alarms.

#### **Analog Outputs**

The instrument is equipped with a maximum of three analog outputs one for each measured gas. The outputs type is menu selectable; voltage output (0 - 5 VDC) or current output (0 - 20 mA, 2 - 20 mA or 4 - 20 mA). The current output can also be configured as a voltage output of 0 - 10V, by configuring the jumper (JP3) on the rear panel PCA.

#### **Analog Inputs**

The instrument is also equipped with three analog voltage inputs (0 - 5 VDC CAT 1) with resolution of 15 bits plus polarity.



#### **CAUTION**

Exceeding these voltages can permanently damage the instrument and void the warranty.

#### **Digital Status Inputs**

The instrument is equipped with eight logic level inputs (0 - 5 VDC CAT 1) for the external control of zero/span calibration sequences.



**CAUTION**

Exceeding these voltages can permanently damage the instrument and void the warranty.

### Digital Status Outputs

The instrument is equipped with eight open collector outputs, which will convey instrument status conditions and warning alarms such as no flow, sample mode, etc.



**CAUTION**

Exceeding 12 VDC or drawing greater than 400 mA on a single output or a total greater than 2 amps across the eight outputs can permanently damage the instrument and void the warranty.

### Bluetooth

This allows for remote access of the instrument to any Android device with the Serinus remote application installed. It uses Bluetooth to control the instrument, view parameters, download data and construct real-time graphs.

## 2. Installation

### 2.1 Initial Check

#### Packaging

The Serinus 60 is transported in packaging which is specifically designed to minimise the effects of shock and vibration during transportation. Ecotech recommends that the packaging be kept if there is a likelihood that the instrument is going to be relocated.

**Note:** The red plastic caps that seal the pneumatic connections during transport must be removed prior to operation.

#### Opening the Instrument

Check the interior of the instrument with the following steps:

1. Undo the screws located in the rear panel.
2. Open the chassis lid by releasing the latch (pressing the button) located on the front panel in the top left-hand corner, slide the lid backwards.
3. To completely remove, slide the lid backwards until the rollers line up with the gaps in the track and pull the lid upwards to remove from the instrument (refer to Figure 4).
4. Check that all pneumatic and electrical connectors are connected. If not, reconnect.
5. Check for any visible and obvious damage. If damage exists contact your supplier and follow the instructions in (Claims for Damaged Shipments) and (Shipping Discrepancies) at the front of this manual.

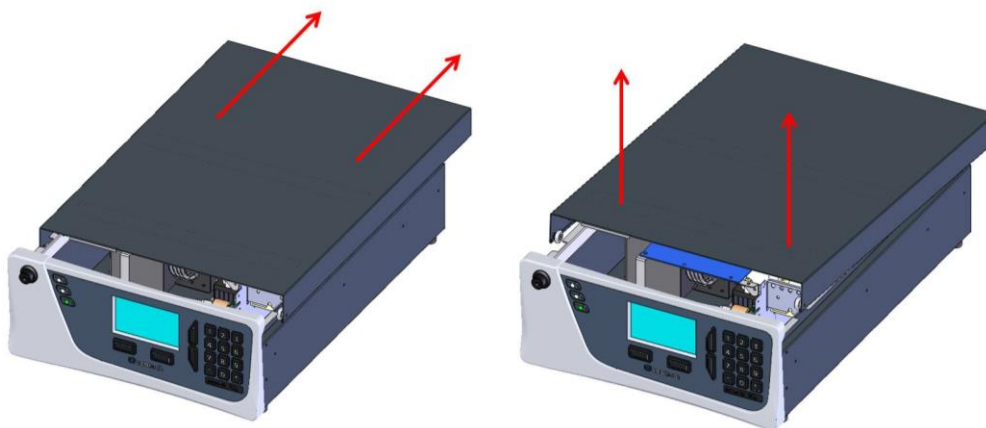

**Figure 4 – Opening the Instrument**

## Items Received

With the delivery of the Serinus 60, the user should have received the following:

- Ecotech Serinus 60 Analyser PN: E020060
- Green Ecotech Resources USB Stick PN: H030137-01
- Manual PN: M010060 (hardcopy optional)
- USB Memory Stick PN: H030021
- USB Cable PN: COM-1440
- Power Lead (120V)\* USA PN: C040007
- Power Lead (240V)\* Australia PN: C040009
- Europe PN: C040008
- UK PN: C040010

\*The power lead received depends on the mains supply of the country (120V or 240V).

**Note:** Check all these items have been delivered undamaged. If any item appears damaged, please contact your supplier before turning the instrument on.

---

## 2.2 Installation Notes

---

When installing the instrument the following points must be taken into account:

- The instrument should be placed in an environment with minimal dust, moisture and variation in temperature (20-30 °C for U.S. EPA designated range).
- For best results the instrument should be located in a temperature and humidity controlled environment (air conditioned shelter). An enclosure temperature of 25-27 °C is optimum.
- Whether in a rack or placed on a bench, the instrument should not have anything placed on top of it or touching the case.
- Instruments should be sited with easy access to the front panel (instrument screen/USB memory stick) and to the back panel (communication ports/pneumatic connections).
- It is recommended that the sample line be as short as possible and/or a heated manifold be used for sampling (minimising moisture condensation in the sample).
- Do not pressurize the sample line under any circumstances. Sample should be drawn through the instrument under atmospheric pressure. This should be achieved by using an external vacuum pump connected to the exhaust port of the instrument.
- When supplying span gas, ensure the flow is approximately 1 slpm and excess is sufficiently vented.

**Note:** The power on/off switch is accessible from the rear of the instrument only. Install the instrument so that the on/off power switch is accessible.

## 2.3 Instrument Set-Up

After installing the instrument the following procedures should be followed to ready the instrument for monitoring:

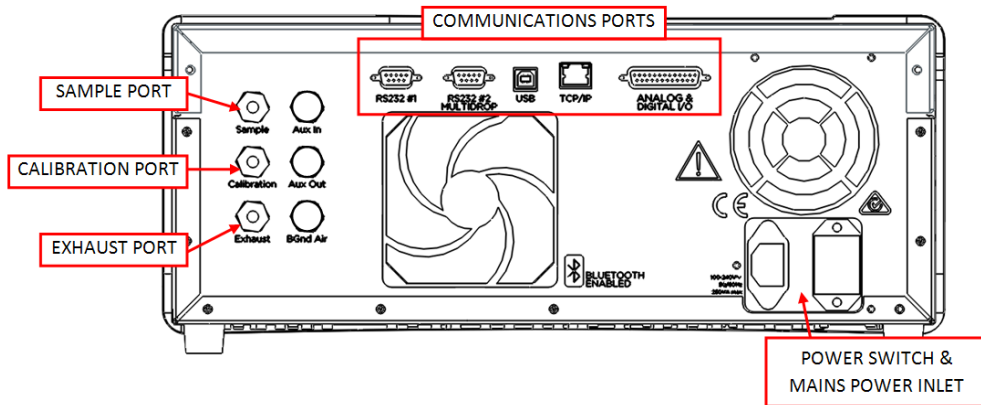

**Figure 5 – Instrument Back Panel**

### 2.3.1 Pneumatic Connections

The Serinus 60 has three pneumatic ports on the back panel of the instrument: the **Sample Port**, the **Calibration Port** and the **Exhaust Port**. All tubing and fittings used should follow the instructions below:

- Must be made of Teflon® FEP material, Kynar®, stainless steel, glass or any other suitably inert material.
- Sample line should be no more than two meters in length with ⅛ inch ID and ¼ inch OD.
- Sample inlet pressure should not exceed 5 kPa above ambient pressure.
- Tubing must be cut squarely and any burrs removed.
- Remove the inlet port nut and insert the tubing through the back of the nut with the tube extending one inch through the front.
- Place the tubing into the port until it hits the tube stop inside the fitting.
- Place the nut back onto the fitting and tighten clockwise until finger tight.
- Nuts should be re-tightened when instrument reaches operating temperature.

### Sample Port

The sample port must be connected to an ambient source of sample air. When using a sample manifold the Serinus requires at least 1 slpm delivered to the sample manifold (0.5 slpm for measurement plus approximately 50 % excess).

## Calibration Port

The calibration port can be connected to the span/zero sources. It is recommended that a gas calibrator (Ecotech's Serinus Cal 1000) be used with a cylinder of nitrogen dioxide to deliver precise concentrations of nitrogen dioxide.

**Note:** All connections to this port should not exceed ambient pressure. A vent is required for excess span gas.

## Exhaust Port

The exhaust port is where the measured sample, calibration gases and background gas are exhausted from the instrument. The exhaust port should be connected to the vacuum pump using ¼" OD tubing. The P030004 240 V vacuum pump (P030005 110 V) available from Ecotech, should be used to provide the required vacuum and flow for one Serinus 60 analyser.



### CAUTION

Nitrogen dioxide is a toxic gas. It is recommended that exhaust air is expelled into an unoccupied area, as it contains levels of nitrogen dioxide. The exhaust must be a suitable distance from the sample inlet to avoid influencing the ambient measurements.

### 2.3.2 Power Connections



### CAUTION

When connecting the mains power to the instrument, the following must be adhered to otherwise the safety and the reliability of the instrument may be compromised.

- A three pin mains power lead with a protective earth conductor **MUST** be used.
- The mains power outlet (wall socket) must be in the range of 100-240 VAC, 50 to 60 Hz.
- The mains power outlet must be protected by an earth leakage protection circuit.
- Connect the instruments power lead into the mains power outlet and turn the power switch on.

### 2.3.3 Communications Connections

There are a number of ways to communicate with the instrument. Use the supplied Airodis software to access the instrument and download data. The Airodis software is supplied on the green Ecotech resources USB stick provided with this instrument.

#### RS232 #1

Connect this port to a data logger (such as WinAQMS) with an RS232 cable.

#### RS232 #2

Connect the RS232 cable from the instrument to a computer or data logger in a multidrop formation.



**Note:** When using multidrop ensure each instrument is given a unique **Serial ID**.

## USB

Connect a standard type B USB cable (supplied with the instrument) to this port.

## TCP/IP (optional)

Plug in an ethernet cable (this cable should be attached to a network).

## Analog/Digital

This port is used to send and receive analog and digital signals. It is normally used to connect with a gas calibrator or to activate alarm signals.

Each instrument contains eight digital inputs, eight digital outputs, three analog inputs and three analog outputs.

## Bluetooth

Connection is enabled using Ecotech's Serinus Remote Android Application.

Use the Serinus Remote Android Application to access instrument and download data. It is available for download directly from the Google Play Store. Search for "Ecotech Serinus Remote".

### 2.3.4 Instrument Set-Up

1. Open the lid and ensure the USB memory stick is installed (refer to Figure 6).
2. Check the battery is turned on at the main controller PCA (refer to Figure 7).
3. Turn on the instrument and allow the warm-up procedure to complete (refer to Section 3.1)
4. Set the time and date (refer to Section 3.4.8).
5. Set the digital filter to the desired setting (refer to Section 3.4.9).
6. Set the internal data logging options (refer to Section 3.4.22).
7. Set the analog/digital inputs and outputs settings (refer to Section 3.4.24).
8. Perform a pressure sensor check (refer to Section 6.3.8).
9. Perform a leak check (refer to Section 6.3.6).
10. Leave the instrument to warm-up and stabilise for two-three hours.
11. Follow the procedure for a multipoint precision check (refer to Section 5.7).
12. The instrument is now ready for operation.

---

## 2.4 Transporting/Storage

---

Transporting the Serinus should be done with great care. It is recommended that the original packaging material the Serinus was delivered in should be used when transporting or storing the instrument.

When transporting or storing the instrument the following points should be followed:

1. Turn off the instrument and allow it to cool down.
2. Remove all pneumatic, power and communication connections.
3. If storing over a long period (six months) turn the battery off by switching the DIP switch (S1) on the main controller PCA (refer to Figure 7).
4. Remove the instrument from the rack.
5. Replace the red plugs into the pneumatic connections.
6. Remove the USB memory stick and pack with instrument (refer to Figure 6).
7. Place the instrument back into a plastic bag with desiccant packs and seal the bag (ideally the bag supplied upon delivery).
8. Place the instrument back into the original foam and box it was delivered in. If this is no longer available find some equivalent packaging that provides protection from damage.
9. The instrument is now ready for long term storage or transportation.

**Note:** After transport or storage the instrument must be set-up and calibrated (refer to Section 2.3.4).

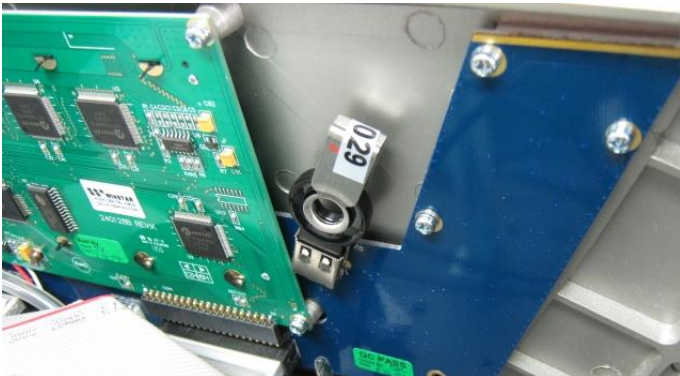

**Figure 6 – Installation of USB Memory Stick**

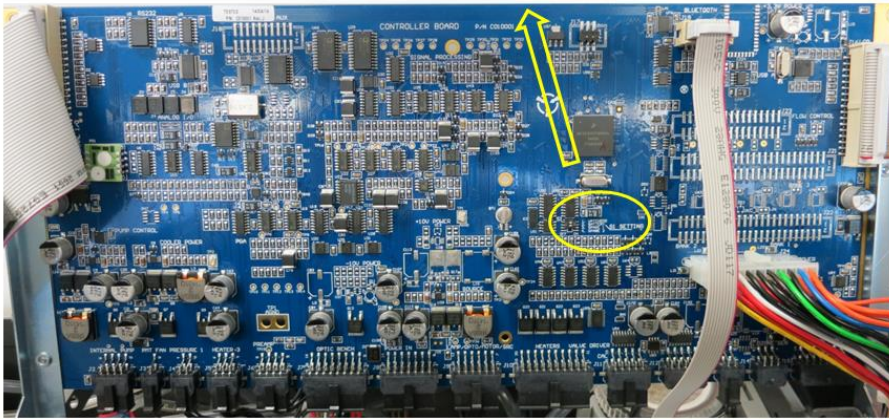

**Figure 7 – Switching the Battery On/Off**

This page is intentionally blank.

## 3. Operation

### 3.1 Warm-Up

When the instrument is first turned on it must go through a period of adjustment and calibration. No measurements are taken during this warm-up period.

The following activities occur during warm-up:

#### Int. Pump Adjust

If the internal pump option is enabled, the instrument remains in warm-up until the flow is within 10% of target.

#### Cell Temperature

The instrument will wait until it reaches 90% of target set point.

After this warm-up has completed the instrument will perform a background and then enter the normal measurement cycle (refer to Section 3.2).

### 3.2 Measurement

The Serinus 60 NO<sub>2</sub> Analyser primarily operates in the sample measure cycle continuously. A background is performed after warm-up, and then normally once every 24 hours (by default) or as defined in the **Measurement Settings Menu** which can be edited by the user. The background is an extinction measure without NO<sub>2</sub> present in the cell and is subtracted from sample measurements.

Table 2 – Measurements Times

Instrument State	Duration (seconds)	Description
BKGND FILL	120	background air is drawn through the measurement cell purging the system
BKGND MEAS	30	Background air drawn through the measurement cell is measured six times and then averaged
NO2 SAMPLE FILL	60	Sample is drawn through the cell purging the system
NO2 SAMPLE MEAS	5	NO <sub>2</sub> sample is measured

### 3.3 General Operation Information

#### 3.3.1 Keypad & Display

The instrument is operated with the use of four sets of buttons:

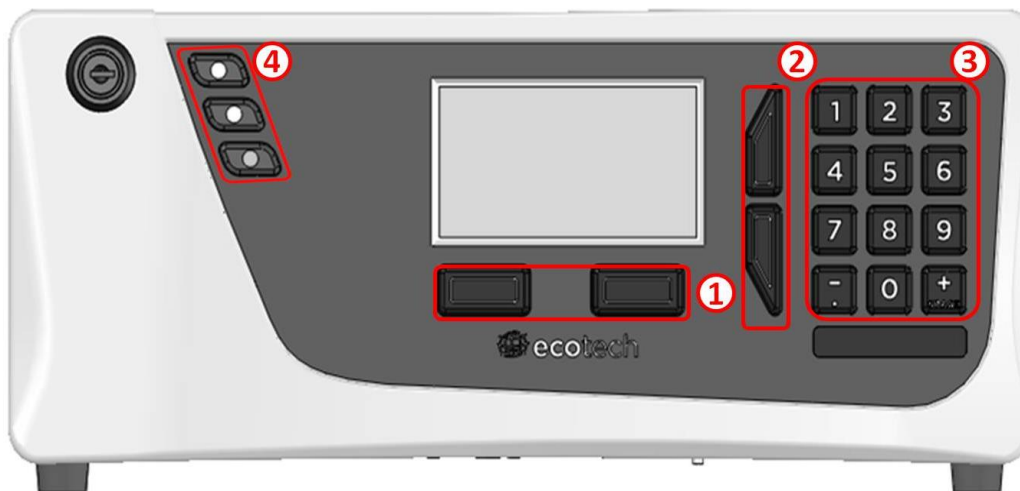

**Figure 8 – Front Panel**

### **Selection Buttons (1)**

The selection buttons will perform the function specified directly above it on the screen. Generally this involves opening a menu, editing a value, accepting or cancelling an edit operation or starting an operation.

### **Scrolling Buttons (2)**

The scrolling buttons allow users to scroll up and down through menus or selection boxes. The scrolling buttons are also used to scroll side to side through editable fields such as: Dates, Times, Numbers etc.

On the home screen these buttons are used for adjusting the screen contrast. Press and hold the up button to increase contrast; press and hold the down button to decrease.

### **Keypad (3)**

The keypad contains the numbers 0-9, a decimal point/minus key (  $\bar{\cdot}$  ) and a space/plus key (  $\bar{\cdot}$  <sub>SPACE</sub> ).

In the few cases where letters can be entered, the number keys act like a telephone keypad. Every time a number key is pressed, it cycles through its choices. The up/down arrow keys scroll through all the numbers and the entire alphabet.

- 1 = 1 or space
- 2 = 2, A, B, C, a, b, c
- 3 = 3, D, E, F, d, e, f
- 4 = 4, G, H, I, g, h, i
- 5 = 5, J, K, L, j, k, l
- 6 = 6, M, N, O, m, n, o
- 7 = 7, P, Q, R, S, p, q, r, s
- 8 = 8, T, U, V, t, u, v
- 9 = 9, W, X, Y, Z, w, x, y, z
- 0 = 0 or space

The (SPACE<sup>+</sup>) and key (−) button functions depend on context. When editing a floating point number, the key (−) inserts a negative sign if the editing cursor is at the start of the number and negative signs are allowed. Otherwise it moves the decimal place to the current cursor location. The (SPACE<sup>+</sup>) key inserts a positive sign if the cursor is at the start of the number; otherwise it enters a space. For non-floating point numbers, these keys usually increment or decrement the current value by 1. When editing the month field of a date, the (SPACE<sup>+</sup>) and (−) key change the month.

### Instrument Status Light Buttons (4)

Located in the top left corner, these lights indicate the status of the instrument as a whole.

- A red light indicates that the instrument has a major failure and is not functioning.
- An orange light indicates there is a minor problem with the instrument, but the instrument may still take measurements reliably.
- A green light indicates that the instrument is working and there are no problems.

In the case of an orange or red light enter the **Status Menu** to find which components are failing (refer to Section 3.4.4) or pressing the orange or red light when illuminated will bring up a pop up box with a full list of current faults.

Pressing the green status light button at any time will cancel any open edit box or menu and return the user to the home screen.

If no instrument status lights are on and the keypad is backlit, this indicates that the instrument is running the bootloader. The screen will also indicate that it is in the bootloader menu.

### 3.3.2 Home Screen

The home screen is composed of seven parts: readings (1), error/status line (2), instrument activity line (3), selection buttons (4), time/date (5), concentration units (6) and USB status (7).

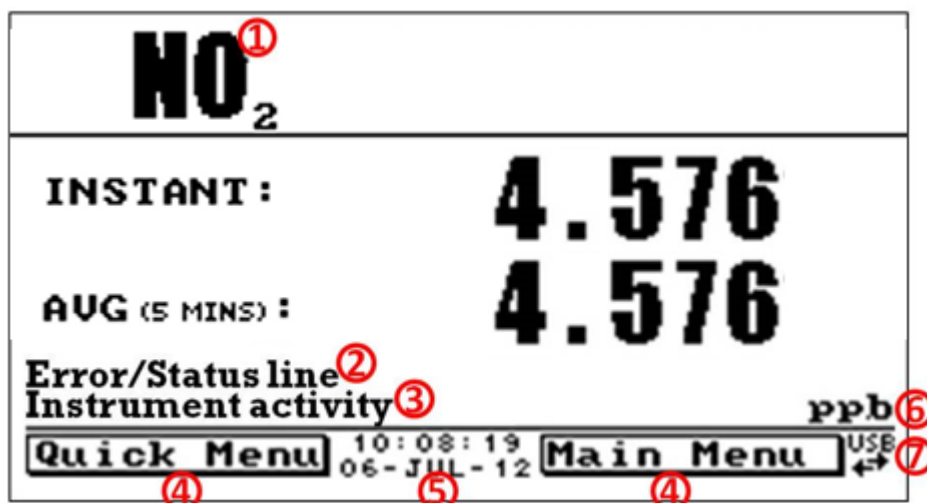

Figure 9 – Home Screen

### Readings (1)

Displays the concentration being measured in real-time. The display can be configured to show just the instantaneous data or the instantaneous and average data (refer to Section 3.3.2 **Home Screen**).

### Error/Status Line (2)

The error/status line provides users with information on any problems the instrument may have. It displays the highest priority error or status condition contained in the **Status Menu** (refer to Section 3.4.4).

### Instrument Activity (3)

This line shows what function the instrument is currently performing. Generally, it will show three groups of actions: Warm-up, Measurement or Calibration.

### Selection Buttons (4)

These buttons are used on the home screen to enter one of two menus. The **Quick Menu** (refer to Section 3.4.1) contains all information and features necessary for scheduled maintenance. The **Main Menu** (refer to Section 3.4.2) contains all information and fields available to users and is generally only used during initial set-up and diagnostics.

### Time and Date (5)

The time and date are displayed in between the menu buttons at the bottom of the screen.

### Concentration Units (6)

The instrument units are displayed in the bottom right hand corner of the display.

### USB Detection (7)

A USB symbol will be displayed in the bottom right corner when the USB memory stick is plugged in (the USB socket is behind the front panel). If the USB symbol is not shown, the USB memory stick should be inserted. Underneath the USB symbol arrows may be displayed which indicates data transfer. The USB memory stick must not be removed whilst the arrows are visible.

**Note:** To safely remove the USB memory stick, navigate to the **Quick Menu** and use the **Safely Remove USB Stick** function (refer to Section 3.4.1).

---

## 3.4 Menus & Screens

---

The menu system is divided into two sections, the **Quick Menu** and the **Main Menu** selectable from the **Home Screen**. The **Quick Menu** contains all information and operations necessary during scheduled maintenance visits. The **Main Menu** contains all fields that are accessible to users. It provides information on component failures and measurement parameters as well as editable fields and test procedures.

In general, editable parameters are displayed in bold font. Non-editable information is displayed in a thin font. Some parameters may become editable based on the state of the instrument.



For example, the manual calibration type and mode can only be changed when the instrument has finished the warm-up process.

### 3.4.1 Quick Menu

The **Quick Menu** contains all the maintenance tools in one easy to use screen. It allows operators to perform calibrations, check important parameters and review the service history.

<b>Span Calibrate NO2</b>	This field is used to perform a span calibration and should be only used when a known concentration of span gas is running through the measurement cell and the reading is stable.  Activating the span calibrate field for a named gas will open a dialog box. Enter the concentration of the span gas that the instrument is sampling and press <b>Accept</b> .
<b>Event Log</b>	This field enters a screen with a log of all the events that the instrument has performed. These events include errors and warnings. This log is stored on the removable USB memory stick. The log is organised by month. When you enter this screen you will be prompted to enter the month for which you wish to view events.
<b>Instrument</b>	This field allows the instrument to be set to either <b>Online</b> (normal instrument operation) or <b>In Maintenance</b> (data is flagged as invalid).
<b>Safely Remove USB Stick</b>	Always select this menu item before removing the USB memory stick or select the same menu item from the <b>Service Menu</b> (refer to Section 3.4.12). Failure to do this may cause corruption of the memory stick.
<b>Instrument Gain</b>	This is a multiplication factor which is used to adjust the concentration measurement to the appropriate level (set by performing a <b>Span Calibrate</b> ). This should be recorded after each calibration in the station log book.
<b>Next Service Due</b>	A field that notifies the user when the next instrument service is due. This value is editable in the Next Service Due field of the Advanced Menu (refer to Section 3.4.30). This field is only displayed in the two weeks prior to the date displayed in this field or after the date has occurred.

### 3.4.2 Main Menu

There are six menus on the **Main Menu** screen.

<b>Analyser State Menu</b>	Refer to Section 3.4.3.
<b>General Settings Menu</b>	Refer to Section 3.4.8.
<b>Measurement Settings Menu</b>	Refer to Section 3.4.9.
<b>Calibration Menu</b>	Refer to Section 3.4.10.
<b>Service Menu</b>	Refer to Section 3.4.12.

**Communications Menu** Refer to Section 3.4.21.

### 3.4.3 Analyser State Menu

#### Main Menu → Analyser State Menu

This displays the status of various parameters that affect instrument measurements.

<b>Status Menu</b>	Refer to Section 3.4.4.
<b>Temperature Menu</b>	Refer to Section 3.4.5.
<b>Pressure &amp; Flow Menu</b>	Refer to Section 3.4.6.
<b>Voltage Menu</b>	Refer to Section 3.4.7.
<b>Model</b>	This field will always display Serinus.
<b>Variant</b>	The variant of the Serinus model (e.g. S60).
<b>Range</b>	The range of the Serinus model (Standard, High or Trace).
<b>Ecotech ID</b>	The Ecotech ID number.
<b>Serial No.</b>	The main controller PCA serial number.
<b>Board Revision</b>	The main controller PCA version.
<b>Firmware Ver.</b>	This field displays the firmware version currently in use on this instrument. This can be important when performing diagnostics and reporting back to the manufacturer.
<b>Power Failure</b>	This field displays the time and date of the last power failure or when power was disconnected from the instrument.

### 3.4.4 Status Menu

#### Main Menu → Analyser State Menu → Status Menu

The **Status Menu** presents a list of the current **Pass/Fail** statuses of the main components. During warm-up, the status of some parameters will be a dashed line.

<b>Event Log</b>	This field enters a screen with a log of all the events that the instrument has performed. These events include errors and warnings. This log is stored on the USB memory stick. The log is organised by month. When you enter this screen you will be prompted to enter the month for which you wish to view events.
<b>Show Error List</b>	This field allows the user to display the list of current errors and warnings on the screen.
<b>Next Service Due</b>	This field is visible with the next service due date if the service is due within the next two weeks.
<b>+5V Supply</b>	Pass if the +5 V power supply is within the acceptable range.
<b>+12V Supply</b>	Pass if the +12 V power supply is within the acceptable range.

<b>+Analog Supply</b>	Pass if the analog power supply is within the acceptable range (+12 V).
<b>-Analog Supply</b>	Pass if the analog power supply is within the acceptable range (-12 V).
<b>A2D</b>	Fail only if a problem is detected with the analog to digital conversion.
<b>Cell Temp.</b>	Pass if the cell heater temperature is within $\pm 10\%$ of the heater set point (CELL) (refer to Section 3.4.5).
<b>Signal</b>	Fail if the detector signal voltage falls below a calculated level.
<b>Interface PCA</b>	Pass if the Interface PCA is functioning correctly.
<b>System Power</b>	Pass if the system has an adequate electrical supply.
<b>Maintenance Mode</b>	Error if the system is “ <b>In Maintenance</b> ” (refer to Section 3.4.12).
<b>Diagnostic PTF Comp</b>	Error if the <b>Pres/Temp/Flow Comp.</b> is disabled (refer to Section 3.4.13).
<b>Diagnostic Control</b>	Error if the control loop is disabled (refer to Section 3.4.13).
<b>Valve Manual Control</b>	Error if the valve sequencing is disabled (refer to Section 3.4.16).
<b>Pressure Calibration</b>	Error if the user is performing a pressure calibration.
<b>Flow Calibration</b> <b>[Internal Pump Option]</b>	Error if the user is performing a flow calibration.
<b>Flow Fault</b>	Ok when the instrument has acceptable sample flow based on the difference between cell and ambient pressures.
<b>Flow Block Temp.</b> <b>[Internal Pump Option]</b>	Pass if the flow block heater temperature is within $\pm 10\%$ of the heater set point (FLOW) (refer to Section 3.4.5).
<b>Chassis Temp.</b>	Pass if the chassis temperature is within the acceptable limits (0-50 °C).
<b>USB Stick Disconnected</b>	Detects whether a USB memory stick is plugged into the front USB port.
<b>Instrument Warmup</b>	Ok once the instrument is out of warm-up status.
<b>High Background</b>	Pass if the background value is below 1100 Mm <sup>-1</sup> .
<b>Backgrounds Disabled</b>	Ok if the menu item <b>Backgrounds</b> in the measurement settings menu is enabled.

### 3.4.5 Temperature Menu

**Main Menu → Analyser State Menu → Temperature Menu**

<b>Temperature Units</b>	The current temperature units of the instrument ( <b>Celsius</b> , <b>Fahrenheit</b> or <b>Kelvin</b> ).
<b>Set Point (CELL)</b>	The temperature set point of the measurement cell. The factory default is 50 °C.

<b>Set Point (FLOW)</b> [Internal Pump Option]	The temperature set point of the flow block. The factory default is 50 °C.
<b>Cell</b>	Displays current temperature of the measurement cell.
<b>Flow Block</b> [Internal Pump Option]	Displays current temperature of the flow block.
<b>Chassis</b>	Displays the temperature of air inside the chassis, measured on the main controller PCA.

---

### 3.4.6 Pressure & Flow Menu

**Main Menu → Analyser State Menu → Pressure & Flow Menu**

<b>Pressure Units</b>	Select the units that the pressure will be displayed in ( <b>torr, PSI, mBar, ATM</b> or <b>kPa</b> ).
<b>Ambient</b>	Current ambient pressure.
<b>Cell</b>	Current pressure within the measurement cell.
<b>Internal Pump</b> [Internal Pump Option]	Current pressure within the flow block.
<b>Flow Units</b>	Select the units that the sample flow will be displayed in ( <b>slpm</b> or <b>L/min</b> ).
<b>Sample Flow</b>	Indicates the gas flow through the sample port of the instrument. The value should be ~0.50 slpm. If there is an error with the sample flow, it will read 0.00 slpm.

---

### 3.4.7 Voltage Menu

**Main Menu → Analyser State Menu → Voltage Menu**

<b>Signal Voltage</b>	This is the signal voltage reading.
<b>+5V Supply</b>	+5 V power supply.
<b>+12V Supply</b>	+12 V power supply.
<b>+Analog Supply</b>	+12 V (primary) power supply. The value should be within ±2 V.
<b>-Analog Supply</b>	-12 V (primary) power supply. The value should be within ±2 V.

---

### 3.4.8 General Settings Menu

**Main Menu → General Settings Menu**

<b>Decimal Places</b>	Select the number of decimal places (0-5) used for the concentration displayed on the home screen.
<b>Conc. Units</b>	Sets the concentration units ( <b>ppm, ppb, ppt, mg/m3, µg/m3</b> or <b>ng/m3</b> ).

---

<b>Conversion Factor</b> [gravimetric units]	This option only appears if concentration units are set to gravimetric ( <b>mg/m<sup>3</sup></b> , <b>µg/m<sup>3</sup></b> or <b>ng/m<sup>3</sup></b> ). Select either <b>0 °C</b> , <b>20 °C</b> or <b>25 °C</b> . This sets the standard temperature used from conversion for measured volumetric values.
<b>Temperature Units</b>	Select the units that temperature will be displayed in ( <b>Celsius</b> , <b>Fahrenheit</b> or <b>Kelvin</b> ).
<b>Pressure Units</b>	Select the units that the pressure will be displayed in ( <b>torr</b> , <b>PSI</b> , <b>mBar</b> , <b>ATM</b> or <b>kPa</b> ).
<b>Flow Units</b>	Select the units that the sample flow will be displayed in ( <b>slpm</b> or <b>L/min</b> ).
<b>Date</b>	Displays the current date and allows users to edit if required.
<b>Time</b>	Displays the current time and allows users to edit if required.
<b>Backlight</b>	Select the length of time the screen and keypad backlight remain on after a button press. The setting <b>Always Off</b> means the backlight never turns on; the setting <b>Always On</b> means the backlight never turns off.
<b>Home Screen</b>	This field allows the user to display concentrations on the <b>Home Screen</b> in two formats. The first is <b>Inst. only</b> which displays only the instantaneous concentration reading, the second is <b>Inst &amp; Avg</b> which displays both instantaneous and average concentration on the <b>Home Screen</b> . The average is measured over the time period set in <b>Measurement Settings Menu</b> (refer to Section 3.4.9).
<b>Char 0 has Slash</b>	When enabled, the instrument will display the zero character with a slash (0) to differentiate it from a capital 'O'.

### 3.4.9 Measurement Settings Menu

#### Main Menu → Measurement Settings Menu

<b>Average Period</b>	Set the time period over which the average will be calculated: Minutes ( <b>1</b> , <b>3</b> , <b>5</b> , <b>10</b> , <b>15</b> or <b>30</b> ) or hours ( <b>1</b> , <b>4</b> , <b>8</b> , <b>12</b> or <b>24</b> ).
<b>Filter Type</b>	Sets the type of digital filter used ( <b>None</b> , <b>10 sec</b> , <b>30 sec</b> , <b>60 sec</b> , <b>90 sec</b> , <b>300 sec</b> or <b>Rolling</b> ).  The filter type set to <b>None</b> is the factory default setting. No filter applied to the readings gives the best overall performance for this instrument.
<b>Rolling Size</b> [Rolling filter]	Sets the number of measurements included in the rolling average. Only available if the <b>Filter Type</b> is set to <b>Rolling</b> .
<b>Backgrounds</b>	The default setting is enabled. When enabled it allows the user to edit the background interval via the following fields <b>Time</b> , <b>Repeat</b> and <b>Units</b> .  When any of the backgrounds fields are edited the instrument will automatically calculate the date and time the next background is due to run and display under each relevant field.
<b>Date</b>	Displays the date that the next background is due to run.

<b>[Backgrounds]</b>	
<b>Time</b> <b>[Backgrounds]</b>	Edit and display the time that the next background will run. The time is set using a 24 hour clock.
<b>Repeat</b> <b>[Backgrounds]</b>	Defines an interval value for the repeat of the background based on the <b>Units</b> selected. This field indicates the delay period; once the specified amount of time has lapsed the background will automatically run again. The user can edit this field but some restriction apply depending on the <b>Units</b> selected. Default is "1".
<b>Units</b> <b>[Backgrounds]</b>	This is where the user can define the type of units for the <b>Repeat</b> delay period. For example: A <b>Repeat</b> of "1" and <b>Units</b> of "Days" means that a calibration will automatically run every day at the defined time. Default is "Days"

### 3.4.10 Calibration Menu

#### Main Menu → Calibration Menu

Calibrating the instrument should be done with care (refer to Section 5 before using these menus).

<b>Cal. Type</b>	<p>Depending on the selection in this field, a number of extra menu items will be displayed. These are separately documented in <b>Manual Mode</b> (refer to Section 3.4.10.1) and <b>Timed Mode</b> (refer to Section 3.4.10.2).</p> <p>Select the <b>Cal. Type</b> field and select either <b>Timed</b> or <b>Manual</b>.</p> <p><b>Timed</b> mode is an automatic calibration controlled by the:</p> <ul style="list-style-type: none"> <li>▪ Interval between cycles</li> <li>▪ Length of each calibration cycle</li> <li>▪ Time when the calibration will begin</li> <li>▪ Check only or automatic compensation</li> </ul> <p>Timed calibration with span compensation enabled does not fulfil U.S. EPA approval.</p> <p><b>Manual</b> mode allows the user to choose the type of calibration they wish to perform and will open the appropriate valves in preparation for the user to perform a manual calibration. The setup used will depend on the <b>Cal. Mode</b> selected.</p> <p><b>Manual</b> mode is set as default.</p>
<b>Zero Source</b>	Select whether the instrument will sample from the external calibration port or from the internal zero source when zero gas is requested.
<b>Cycle Time</b>	The duration of each <b>Cal. Mode</b> (span and zero) when performing <b>Cycle Mode</b> (refer to Section 3.4.10.1) or <b>Cal. Type</b> is set to <b>Timed</b> (refer to Section 3.4.10.2).
<b>Span Calibrate NO2</b>	<p>This field is used to perform a span calibration and should be only used when a known concentration of span gas is running through the reaction cell and the reading is stable.</p> <p>Activating the span calibrate field for a named gas will open a dialog box. Enter the concentration of the span gas that the</p>

---

	instrument is sampling and press <b>Accept</b> .
<b>Zero Calibrate NO2</b>	This command is used to correct the zero calibration setting. This option should be used only when zero gas is running through the reaction cell (refer to Section 5 before using this command).
<b>Manual Background</b>	Immediately perform a background.
<b>Pressure Calibration Menu</b>	This menu allows the user to calibrate the pressure sensors (refer to Section 3.4.11).
<b>Pressure NO2</b>	This field displays the measurement cell pressure measured during the last calibration.
<b>Temperature</b>	Measurement Cell temperature when the last span calibration was performed.

### 3.4.10.1 Manual Mode

These items appear in the **Calibration Menu** when **Cal. Type** is set to **Manual**.

<b>Cal. Mode</b>	<p>When calibration type is set to <b>Manual</b> the instruments operational mode can be chosen from the following:</p> <ul style="list-style-type: none"> <li>▪ <b>Measure:</b> Is the normal measurement through the sample port.</li> <li>▪ <b>Zero:</b> This mode will take air through the calibration port so that a zero calibration can be performed. Data is flagged as zero data.</li> <li>▪ <b>Span:</b> This mode will take air through the calibration port so that a span calibration can be performed. Data is flagged as span data.</li> <li>▪ <b>Cycle:</b> Performs a zero and a span <b>Cal. Mode</b> and then returns to measure mode. The length of time spent measuring each calibration mode is set in <b>Cycle Time</b> (refer to Section 3.4.10).</li> </ul> <p>While the instrument is still in the warm-up period (refer to Section 3.1) the <b>Cal. Mode</b> cannot be changed from <b>Measure</b> mode.</p>
------------------	--

### 3.4.10.2 Timed Mode

These items appear in the **Calibration Menu** when **Cal. Type** is set to **Timed**.

<b>Date</b>	Enter the date for the next calibration to start.
<b>Time</b>	Enter the time that the calibration will be performed. The time is set using a 24 hour clock.
<b>Repeat</b>	This field indicates the delay period; once the specified amount of time has lapsed the calibration will automatically run again. The user can edit this field (from 1 to 20,000 units).
<b>Units</b>	This is where the user can define the type of units for the <b>Repeat</b> delay period. For example: A <b>repeat</b> of “3” and units of “ <b>Days</b> ” means that a calibration will automatically be performed every three days.

---

<b>Span Compensation</b>	<p>When <b>Enabled</b> the instrument will automatically perform a <b>Span Calibrate NO2</b> at the end of the <b>Cycle Time</b> and adjust the gain based on the <b>Span Level</b>.</p> <p>When <b>Disabled</b> it will do a precision check only, no adjustment is made.</p> <p><b>Timed</b> mode with span compensation enabled does not fulfil U.S. EPA approval or EN certification.</p>
<b>Span Level</b>	Enter the concentration of span gas expected. Used when the <b>Span Compensation</b> is <b>Enabled</b> .

### 3.4.11 Pressure Calibration Menu

**Main Menu → Calibration Menu → Pressure Calibration Menu**

Entering this menu will set the valves to the pressure calibration configuration; leaving the menu will restore the valves to normal operation (refer to Section 5.2).

<b>Vacuum Set Pt.</b>	The zero point for the calibration. Activating this item will open a dialog box of instructions.
<b>Ambient Set Pt.</b>	The high point for the calibration. Activating this item will open a dialog box of instructions.
<b>Pressure Units</b>	Select the units that the pressure will be displayed in ( <b>torr, PSI, mBar, ATM</b> or <b>kPa</b> ).
<b>Ambient</b>	The current ambient pressure.
	The current ambient pressure displayed as a raw voltage.
<b>Cell</b>	The current pressure in the measurement cell.
	The current measurement cell pressure displayed as a raw voltage.

### 3.4.12 Service Menu

**Main Menu → Service Menu**

<b>Diagnostics Menu</b>	Refer to Section 3.4.13.
<b>Calculation Factors Menu</b>	Refer to Section 3.4.20.
<b>Load Auto-Backup Config.</b>	Loads the auto-backup configuration file. The configuration is automatically backed up every night at midnight.
<b>Load Configuration</b>	Loads a user selectable configuration file from the USB memory stick.
<b>Save Configuration</b>	Saves all of the EEPROM-stored user-selectable instrument configurations to the USB memory stick (calibration and communication settings, units, instrument gain, etc.). If there are problems with the instrument use this function to save settings to the USB memory stick and send this file (together with the parameter list save) to your supplier with your service enquiry.



<b>Save Parameter List</b>	Saves a text file of various parameters and calculation factors. If you have problems with the instrument use this function to save settings to the USB memory stick and send this file (together with the configuration save) to your supplier with your service enquiry.
<b>Instrument</b>	This field allows the instrument to be set to either <b>Online</b> (normal instrument operation) or <b>In Maintenance</b> (data is flagged as invalid).
<b>Next Service Due</b>	Displays when the next scheduled service is due.
<b>Safely Remove USB Stick</b>	This command must be activated to safely remove the USB memory stick.
<b>System Restart</b>	Activating this will restart the instrument.

### 3.4.13 Diagnostics Menu

#### Main Menu → Service Menu → Diagnostics Menu

<b>Digital Pots Menu</b>	Refer to Section 3.4.14.
<b>Internal Pump Menu</b> [Internal Pump Option]	Refer to Section 3.4.15
<b>Valve Menu</b>	Refer to Section 3.4.16.
<b>Tests Menu</b>	Refer to Section 3.4.17.
<b>Pres/Temp/Flow Comp.</b>	<b>On</b> (default): Is used to compensate instrument measurements for environmental fluctuations that might affect readings (pressure, temperature and flow). <b>Off</b> : Is used only when running diagnostics.
<b>Control Loop</b>	<b>Enabled</b> (default): Allows the instrument to automatically adjust digital pots and other outputs. <b>Disabled</b> : Prevents the instrument from changing most outputs so the service technician can manually control them.

### 3.4.14 Digital Pots Menu

#### Main Menu → Service Menu → Diagnostics Menu → Digital Pots Menu

Digital pots are electronically controlled digital potentiometers used for adjustments to operations of the instrument. Each of the digital pots can go from 0-255. This menu should be accessed only during diagnostics.

Unless the **Control Loop** is **Disabled** (refer to Section 3.4.13), changes to the pots may be modified by the instrument. This is intentional; some diagnostics are best done with instrument feedback and some are best done without.

<b>Extinction</b>	Mm-1	A measure of light scattering and absorption of NO <sub>2</sub> .
<b>Signal Voltage</b>	0.1 - 2.5V	Signal voltage reading

<b>Meas. Count</b>	0 - 15	This value increases by 2 every 5 seconds.
<b>Sig. Count 1</b>	0 - 16777215	A raw intensity count of the response during the first 90° of the signal phase.
<b>Sig. Count 2</b>	0 - 16777215	A raw intensity count of the response during the second 90° of the signal phase.
<b>Sig. Count 3</b>	0 - 16777215	A raw intensity count of the response during the third 90° of the signal phase.
<b>Sig. Count 4</b>	0 - 16777215	A raw intensity count of the response during the final 90° of the signal phase.
<b>LED Drive</b>	0-255	Controls the current used to drive the LED thus varying the intensity.

### 3.4.15 Internal Pump Menu (Option)

**Main Menu → Service Menu → Diagnostics Menu → Internal Pump Menu**

<b>Flow Control</b>	Set to <b>MANUAL</b> to disable the automatic flow control. <b>AUTO</b> allows the flow PID to modify the pump coarse and fine settings. <b>START</b> will transition to <b>AUTO</b> after one second.
<b>Internal Pump</b>	This field allows the internal pump to be turned on or off. This field is only editable when the <b>Flow Control</b> field is set to <b>MANUAL</b> .
<b>Coarse</b>	Internal pump speed control (Coarse). This field is only editable when the <b>Flow Control</b> field is set to <b>MANUAL</b> .
<b>Fine</b>	Internal Pump speed control (Fine). This field is only editable when the <b>Flow Control</b> field is set to <b>MANUAL</b> .
<b>Sample Flow</b>	Current gas flow. This is only accurate when reading close to the flow calibration point.
<b>Internal Pump</b>	The current pressure reading of the flow block which is down stream of the orifice.

### 3.4.16 Valve Menu

**Main Menu → Service Menu → Diagnostics Menu → Valve Menu**

The **Valve Menu** allows the user to observe the instrument controlled switching of the valves. If the valve is On it means the valve is energised. When a three way valve is in the On state it will now be in the NC (normally closed) position as shown in the plumbing schematic. When the valve sequencing is disabled the user has the ability to turn the valve Off and On manually. It is recommended that the valve menu be used by a trained technician following the plumbing schematic (refer to Section 9.5).

**Note:** When interpreting the information below regarding the flow path through the valve note that (NC = Normally Closed), (NO = Normally Open) and (C = common).

<b>Valve Sequencing</b>	<p>When <b>Enabled</b> the valves will turn On and Off under the instruments control (even if you have manually turned <b>Off</b> or <b>On</b> a valve).</p> <p>When <b>Disabled</b> the valves will change only in response to a user's action.</p>
<b>Sample/Cal</b>	<p>Indicates if the <b>Sample/Cal</b> valve on the <b>Calibration Valve Manifold</b> is <b>Off</b> or <b>On</b>. This will determine the port the instrument draws its sample from.</p> <p><b>Off</b> = Flow from NO to C (drawing sample from the <b>Sample Port</b>).</p> <p><b>On</b> = Flow from NC to C (drawing sample from the <b>Sample Port</b> through the charcoal DAU or from the <b>Calibration Port</b> depending on the state of the <b>Background /Cal</b> valve).</p>
<b>Background/Cal</b>	<p>Indicates if the <b>Background/Cal</b> valve on the <b>Calibration Valve Manifold</b> is <b>Off</b> or <b>On</b>. This will determine the port the instrument draws its sample from.</p> <p><b>Off</b> = Flow from NO to C (drawing sample from the <b>Sample Port</b> through the charcoal DAU).</p> <p><b>On</b> = Flow from NC to C (drawing sample from the <b>Calibration Port</b>).</p>
<b>Pressurised Zero [Optional]</b>	Indicates if the optional pressurised zero port valve is <b>Off</b> or <b>On</b> (refer to Section 8.4).
<b>Pressurised Span [Optional]</b>	Indicates if the optional pressurised span port valve is <b>Off</b> or <b>On</b> (refer to Section 8.4).

### 3.4.17 Tests Menu

Main Menu → Service Menu → Diagnostics Menu → Tests Menu

<b>Screen Test</b>	Performs a screen test by drawing lines and images on the screen so that the operator can determine if there are any faults. Press a keypad key to step through the test. The up and down arrow keys will adjust the contrast.
<b>Digital Input Test Menu</b>	Refer to Section 3.4.18.
<b>Digital Output Test Menu</b>	Refer to Section 3.4.19.

### 3.4.18 Digital Input Test Menu

Main Menu → Service Menu → Diagnostics Menu → Tests Menu → Digital Input Test Menu

<b>Input 0..7</b>	Displays the status of the 0-7 digital input pins. Value will be 0 or 1.
-------------------	--

**Note:** Entering either the Digital Inputs Menu will temporarily disable all digital and analog input/outputs. This will affect logging via these outputs. Exiting the menu restores automatic control.

### 3.4.19 Digital Output Test Menu

Main Menu → Service Menu → Diagnostics Menu → Tests Menu → Digital Output Test Menu

<b>Automated Test</b>	When started will automatically step through each output, turning it On and Off.
<b>Output 0..7</b>	Displays the state of the output pin ( <b>On</b> or <b>Off</b> ) and allows the user to manually set the state.

**Note:** Entering either the Digital Outputs Menu will temporarily disable all digital and analog input/outputs. This will affect logging via these outputs. Exiting the menu restores automatic control.

### 3.4.20 Calculation Factors Menu

Main Menu → Service Menu → Calculation Factors Menu

The **calculation** factors provide the values used to calculate different aspects of measurement and calibration.

<b>Dilution Ratio</b>	<p>Entering a value here will multiply the displayed and recorded measurements by the dilution amount. For example, if the instrument is measuring a source where the average concentration is above the upper limit of the measurement range, a dilution probe with a fixed ratio dilution ratio can be used to reduce the level measured by the instrument, so for a 4:1 dilution ratio, enter a value of 4.</p> <p>Enter the ratio here so the instrument can display the correct value on the instrument.</p> <p>The default value is 1.00 (this indicates no dilution is applied).</p>
<b>Instrument Gain</b>	A multiplication factor used to adjust the concentration measurement to the appropriate level (set at calibration).
<b>Zero Offset NO2</b>	This field displays the offset created from a NO <sub>2</sub> zero calibration. This is the concentration measured from zero air and is subtracted from all readings.
<b>Extinction</b>	A measure of light scattering and absorption of NO <sub>2</sub> .
<b>Background</b>	The value of the extinction measure without NO <sub>2</sub> present.
<b>PTF Correction NO2</b>	Displays the correction factor applied to the concentration measurement. This correction is for changes in pressure, temperature and flows since the last calibration.
<b>Noise</b>	<p>The standard deviation of the concentration. The calculation is as follows:</p> <ul style="list-style-type: none"> <li>▪ Take a concentration value once every two minutes.</li> <li>▪ Store 25 of these samples in a first in, last out buffer.</li> <li>▪ Every two minutes, calculate the standard deviation of the current 25 samples. This is a microprocessor-generated field and cannot be set by the user.</li> </ul> <p>This reading is only valid if zero air or a steady concentration of span gas has been supplied to the instrument for at least one hour.</p>

### 3.4.21 Communications Menu

#### Main Menu → Communications Menu

Configures how the instrument communicates with external instrumentation and data loggers.

Data Logging Menu	Refer to Section 3.4.22.
Serial Communication Menu	Refer to Section 3.4.23.
Analog Input Menu	Refer to Section 3.4.24.
Analog Output Menu	Refer to Section 3.4.25.
Digital Input Menu	Refer to Section 3.4.26.
Digital Output Menu	Refer to Section 3.4.27.
Network Menu	Refer to Section 3.4.28.
Bluetooth Menu	Refer to Section 3.4.29.

### 3.4.22 Data Logging Menu

#### Main Menu → Communications Menu → Data Logging Menu

When editing the numeric or text menus, the “-” key will delete the current parameter and move the others up to take its place; the “+” key will insert a parameter at the current location and move the ones below it down. The internal logger can log a maximum of 12 parameters.

Data Log Interval	Displays the interval at which the data is saved to the USB memory stick. Selecting a <b>1 sec</b> interval may result in occasional measurements not being logged or slow response to serial commands.
Data Log Setup – Numeric	Numeric list of the parameters logged. This is a quicker way to enter parameters (for lists of parameters refer to Table 19).
Data Log Setup – Text	Select the list of logged parameters by name.

### 3.4.23 Serial Communication Menu

#### Main Menu → Communications Menu → Serial Communication Menu

Serial ID	This is the ID of the instrument when using multidrop RS232 communications. This ID can be changed to support multiple instruments on the same RS232 cable.
Bayern-Hessen ID [Bayern-Hessen Protocol]	This is the Bayern-Hessen ID used by the Bayern-Hessen Protocol.
NO2 ID [Bayern-Hessen Protocol]	This is the ID of the NO <sub>2</sub> gas used by the Bayern-Hessen Protocol.
Service port (RS232 #1) Multidrop port (RS232 #2)	The port parameters below are repeated for each serial port.

<b>Serial Delay</b>	Some older communication systems require a delay before the instrument responds to a serial command. The number of milliseconds of delay required (0-1000). The default is 0, meaning the instrument responds as quickly as possible to any serial request.
<b>Baudrate</b>	Sets the baud rate for this serial port ( <b>1200, 2400, 4800, 9600, 14400, 19200, 38400</b> or <b>115200</b> ).
<b>Protocol</b>	Sets the protocol used for this serial port ( <b>Advanced, ModBus, EC9800</b> or <b>Bayern-Hessen</b> ). This must be set to <b>Advanced</b> for Ecotech supplied software.
<b>Endian</b> [Modbus Protocol]	Select <b>Little</b> or <b>Big</b> endian mode for ModBus protocol.

### 3.4.24 Analog Input Menu

**Main Menu → Communications Menu → Analog Input Menu**

The Serinus supports three analog inputs from the 25 pin I/O connector. Each input is a 0 to 5 volt CAT 1 input that can be scaled and logged to the USB memory stick or accessed remotely as parameters 3 to 5.



**CAUTION**  
Exceeding these voltages can permanently damage the instrument and void the warranty.

<b>Input 1/2/3</b>	The sections below are repeated for each analog input.
<b>Multiplier</b>	The input voltage will be multiplied by this number. For example, if a sensor has a 0-5V output for a temperature of -40 °C to 60 °C, the multiplier would be $(60 - (-40)) / 5 = 20$ .
<b>Offset</b>	This value will be added to the above calculation. Continuing the example in the multiplier description, the offset should be set to -40, so that a voltage of 0V will be recorded as -40°C.
<b>Reading</b>	The current reading from the input voltage, after the multiplier and offset has been applied. This is the value that is logged or reported as parameter 3 to 5 via USB or serial requests.

### 3.4.25 Analog Output Menu

**Main Menu → Communications Menu → Analog Output Menu**

<b>Output Mode</b>	The analog output can be set to be either <b>Current</b> or <b>Voltage</b> . Different fields will be displayed depending on which analog output type is selected.
<b>NO2</b>	The name of the gas for each analog output. All of the fields below are repeated for each gas.

<b>Min Range</b>	Set the lower range limit (in concentration units). This is the value at which the analog output should be at its minimum. For example, 4 mA for a 4 to 20 mA current output.
<b>Max Range</b>	Set the upper range limit (in concentration units). This value can be edited but cannot exceed the <b>Over-Range</b> value. This is the value at which the analog output should be at its maximum. For example, 20 mA for a current output.
<b>Over-Ranging</b>	Set to Enabled or Disabled to turn the over-ranging feature on or off.
<b>Over-Range</b>	This field is only visible when <b>Over-Ranging</b> is set to <b>Enabled</b> . Set to the desired over range value. This value cannot be set below the <b>Max Range</b> value. This is the alternate scale the used for the analog output when over-ranging is active and enabled. When 90 % of the standard range is reached, this over range is automatically entered. When 80 % of the original range is reached, it returns to the original range.

### 3.4.25.1 Analog Output Menu - Voltage

**Main Menu → Communications Menu → Analog Output Menu**

These items appear when **Output Mode** is set to **Voltage**.

<b>Voltage Offset</b>	Choices are <b>0V</b> , <b>0.25V</b> or <b>0.5V</b> . This sets the voltage for a reading of 0. Since the output cannot go negative, this offset can be used to record negative readings.
<b>0.5V Calibration</b>	Enables the user to calibrate the analog voltage output at a low point. Increase/decrease the value until the connected equipment reads 0.5V (refer to Section 4.4.1.1).
<b>5.0V Calibration</b>	Enables the user to calibrate the analog voltage output at a full scale point (5V). Increase/decrease the value until the connected equipment reads 5V (refer to Section 4.4.1.1).

### 3.4.25.2 Analog Output Menu - Current

**Main Menu → Communications Menu → Analog Output Menu**

These items appear when **Output Mode** is set to **Current**.

<b>Current Range</b>	Enables the user to set desired current ranges. The user's choices are <b>0-20mA</b> , <b>2-20mA</b> or <b>4-20mA</b> .
<b>4mA Calibration</b>	Enables the user to calibrate the current output at a low point. Increase/decrease the value until the connected equipment reads 4mA (refer to Section 4.4.1.2).
<b>20mA Calibration</b>	Enables the user to calibrate the current output at a full scale point (20mA). Increase/decrease the value until the connected equipment reads 20mA (refer to Section 4.4.1.2).

### 3.4.26 Digital Input Menu

**Main Menu → Communications Menu → Digital Input Menu**

This menu is used to remotely trigger zero and span calibrations. This is done by assigning the eight digital inputs with one of the following commands.

<b>DI N (Pin X)</b>	<p>Associates an action with a digital input. There are eight available digital inputs (the pin numbers are for the 25-pin connector). Each one can have one of the following associated actions, triggered when the corresponding digital input goes to the <b>Active</b> state:</p> <ul style="list-style-type: none"> <li>▪ <b>Disabled:</b> No action (this digital input does nothing) the pin is forced to Active Low.</li> <li>▪ <b>Do Span:</b> Used to perform a span check When activated the instrument sets the <b>Cal. Mode</b> to <b>Span</b> (refer to Section 3.4.10.1).</li> <li>▪ <b>Do Zero:</b> Used to perform a zero When activated the instrument sets the <b>Cal. Mode</b> to <b>Zero</b> (refer to Section 3.4.10.1).</li> </ul>
<b>Active</b> <b>[DO Span, Do Zero]</b>	<p>Each pin can be set to be active <b>High</b> or <b>Low</b>. Active High means that the event will be triggered when the line is pulled to 5V. Active Low means that the event will be triggered when the line is pulled to 0V.</p>

---

### Example

Here is a typical configuration between an instrument and either a data logger or calibrator (master device):

1. Set the jumper JP1 to 5V position (refer to Section 4.4.3).
2. Connect one of the master devices digital output signals to pin 18 and the ground signal to pin 5 of the instrument’s analog/digital 25 pin female connector (refer to Figure 18).
3. Program master device to output 0 volts to pin 18 when a span is desired.
4. In the instrument’s **Digital Input Menu** assign **DI 0 → Do Span**.
5. Set the **Active** state to **Low**
6. The same procedure can be followed to also activate zero calibrations. Pin 6 of the instrument’s analog/digital 25 pin female connector can be connected to one of the other master devices digital outputs and the instrument can be set so **DI 1** is assigned to **Do Zero**.

### 3.4.27 Digital Output Menu

**Main Menu → Communications Menu → Digital Output Menu**

This allows the instrument to trigger external alarms in response to certain events.

---



There are eight different pins available, which will be set high during an associated event:

<b>DO N (Pin X)</b>	Associates a state with a digital output. There are eight digital outputs (the pin numbers are for the 25 pin connector). Each one can have one of the associated states listed in Table 3 – Digital Output States. The pin will be driven to the active state while the instrument state is true.
<b>Active [DO Enabled]</b>	Each pin can be set to be active <b>High</b> or <b>Low</b> . Active High means that the pin will be pulled to 5V when the associated event occurs. Active Low means the pin will be pulled to 0V when the associated event occurs.

**Table 3 – Digital Output States**

Digital Output State	Description
Disabled	No state (this state is never Active).
Pwr Supply Fail	Power supply fault.
A2D Fail	Analog to digital fault.
Flow Fail	Sample flow fault.
Cell Heat Fail	Cell heater fault.
Flow Heat Fail	Flow block heater fault
Chassis Tmp Fail	Chassis temperature fault.
USB Disconnected	The USB memory stick is disconnected.
Background	Performing a background.
Span	Performing a span check.
Zero	Performing a zero check.
System Fault	Any system fault (the red light is on).
Maintenance Mode	User has activated maintenance mode.
Over Range AO 1	Over range for analog output is active.
Interface PCA Fail	Interface PCA fault.
High Background	Background above 1100 Mm-1
Signal Fail	Signal fault.

### 3.4.28 Network Menu

**Main Menu → Communications Menu → Network Menu**

The **Network Menu** only appears when the **Network Port** is enabled in the Hardware Menu (refer to Section 3.4.31). The **Network Menu** allows the user to view or set the IP Address, Netmask and Gateway if the optional network port is installed.

<b>Start-up Mode</b>	<p>The following modes are available:</p> <ul style="list-style-type: none"> <li>▪ <b>NORMAL:</b> In this mode nothing is done with the network port during boot-up. It is assumed to be configured correctly or unused.</li> <li>▪ <b>READ IP:</b> This mode interrogates the network port for its IP address. The menu will display the network address after boot-up.</li> <li>▪ <b>SET IP:</b> The user may enter an IP address, Netmask and Gateway address (following the usual rules for formatting these addresses). At this time the instrument does not validate the correctness of these entries. When you cycle power, the instrument will first instruct the network port on its new address. It will switch to <b>Read IP</b> mode and read back the address it just set so the user may verify it in the menu.</li> <li>▪ <b>Set DHCP:</b> This sets the network port into DHCP mode, allowing the network to assign the instrument an IP address.</li> </ul>
<b>IP Address</b> [Read or Set mode]	This is the current IP address of the instrument.
<b>Netmask</b> [Read or Set mode]	This is the subnet mask of the network the instrument is connected to.
<b>Gateway</b> [Read or Set mode]	This is the IP address of the router to access addresses not on the same subnet.
<b>Adaptor is in DHCP mode</b> [DHCP mode]	In this mode the instrument will ask for its network parameters from a DHCP server on your network.
<b>Protocol</b>	Sets the protocol used for the network port ( <b>Advanced, ModBus, EC9800</b> or <b>Bayern-Hessen</b> ). This must be set to <b>Advanced</b> for Ecotech supplied software.
<b>Endian</b> [Protocol Modbus]	Select <b>Little</b> or <b>Big</b> endian mode for ModBus protocol.

To read the IP address, perform the following steps:

1. Set the instrument to Read IP.
2. Manually cycle power off.
3. Wait three seconds.
4. Turn power on.
5. Read or set the IP address.

### 3.4.29 Bluetooth Menu

**Main Menu → Communications Menu → Bluetooth Menu**

This instrument supports Bluetooth communication through the Serinus Remote Android Application (refer to Section 4.7).

<b>Bluetooth</b>	This field indicates whether the instrument is remotely connected to an Android device.
<b>Reset</b>	After changing the ID or PIN, it is necessary to reboot the Bluetooth module. This is done by resetting the instrument or by using this menu item to reboot only the Bluetooth.
<b>ID</b>	This is the Bluetooth ID of the instrument. Use the keypad to edit this field (refer to Section 3.3.1 for instructions on entering text with the numeric keypad). The default ID setting is <b>Serinus(Ecotech ID)</b> . The word <b>Serinus</b> is always the first part of the name and cannot be edited. The second part is the <b>Ecotech ID</b> .
<b>PIN</b>	This is a passcode/pin required for the Serinus Remote Application to connect to the instrument. The default pin is 1234.

### 3.4.30 Advanced Menu

This menu is accessed via a different method than the other menus. From the **Home Screen** press the following keys: **( $\square$ )99( $\square$ )<sup>+</sup>(SPACE)**

This menu contains technical settings, diagnostics and factory hardware installations. No items in this menu should be accessed without authorisation and supervision of qualified service personnel.

<b>Language</b>	Select a language.
<b>Hardware Menu</b>	Refer to Section 3.4.31.
<b>Service Displays</b>	When set to <b>On</b> , new items appear on many different menus. These fields are for diagnostic and service personnel only. Default is <b>Off</b> .
<b>Next Service Due</b>	Enables the user to edit the next service due date.
<b>Jump to Next State</b>	Moves the sequence to the next state (e.g. from Fill to Measure). This command is most commonly used to force an instrument out of the warm-up sequence early.
<b>Parameter Display Menu</b>	Refer to Section 3.4.32.
<b>Reset to Factory Defaults</b>	Reset the configuration to factory defaults. This will erase all calibrations and user configuration information.
<b>Rebuild Index</b>	If a data log becomes corrupted it may be possible to restore it by rebuilding its index file. This command will ask you to specify a month and will rebuild the index for that month. This operation can take many minutes and it should not be interrupted. While the file is rebuilding any data logging will be suspended.

### 3.4.31 Hardware Menu

#### Advanced Menu → Hardware Menu

This menu contains factory hardware installations. If you reset to factory defaults you may need to revisit this menu to enable your installed optional features.

<b>Variant</b>	Select the instrument model. Normally this only needs to be reset when the configuration is corrupted. The selections available will depend on licensing. It is not recommended to run an instrument with firmware set to an incorrect model.
<b>Range</b>	Select the range of the instrument. Not all instruments support all ranges. Default is <b>Standard</b> .
<b>Front Panel Style</b>	Choosing the incorrect front panel will result in the traffic lights behaving inconsistently. Default is <b>Aluminium</b> .
<b>Network Port</b>	When <b>Enabled</b> indicates the instrument has a network port installed. Default is <b>Disabled</b> .
<b>Orifice Size</b>	Specify the input orifice. Default is 0.62.
<b>Internal Pump</b>	When <b>Enabled</b> indicates the instrument has an internal pump installed. Default is <b>Disabled</b> .

---

### 3.4.32 Parameter Display Menu

**Main Menu → Advanced Menu → Parameter Display Menu**

Used to display a parameter in real-time on the screen (refer to Table 19 for a full list of parameters).

<b>Data Parameter</b>	This is an editable field. Enter the parameter number you wish to view (refer to Table 19)
<b>Name</b>	Displays the name of the selected parameter.
<b>Value</b>	Displays the current value of the selected parameter.

## 4. Communications

The Serinus has a number of different interfaces for communication with other equipment (RS232, USB, 25 pin digital/analog input/output, TCP/IP network (optional) and Bluetooth). A demonstration version of Ecotech's Airodis software is included with the instrument, enabling basic data downloads and remote operation from a PC running MS Windows (7 or 8). The full version of Airodis is available separately and includes automated collection, data validation and complex reporting by multiple users. Please refer to the Airodis Manual and Section 4.6 for details on setting up and communicating with the Serinus.

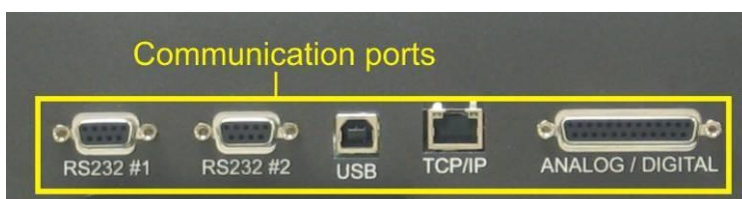

**Figure 10 – Communication Ports**

---

### 4.1 RS232 Communication

---

RS232 communication is a very reliable way to access data from the instrument and is recommended for use in connection to a data logger for 24/7 communication. Both RS232 ports are configured as DCE and can be connected to DTE (Data Terminal Equipment such as a data logger or computer).

Port #2 also supports a multidrop arrangement (a configuration of multiple instruments connected via the same RS232 cable where the transmit signal is only asserted by the instrument that is spoken to).

For reliable multidrop RS232 communications please follow these guidelines:

- Verify that the Serial ID is set to a unique value which is different to the other instruments in the chain (refer to Section 3.4.23).
- All of the instruments in the multidrop chain must have the same baud rate and communication protocol settings. A maximum of 9600 baud rate is recommended.
- The multidrop RS232 cable should be kept to less than three meters in length.
- A 12K ohm terminating resistor should be placed on the last connector of the cable (connect from pin 2 to pin 5 and from pin 3 to pin 5 – refer to Figure 11).
- The shielding of the multidrop cable must be continuous throughout the cable.
- The shielding of the multidrop cable must only be terminated at one end. It should be connected to the metal shell of the DB 9 way connector.

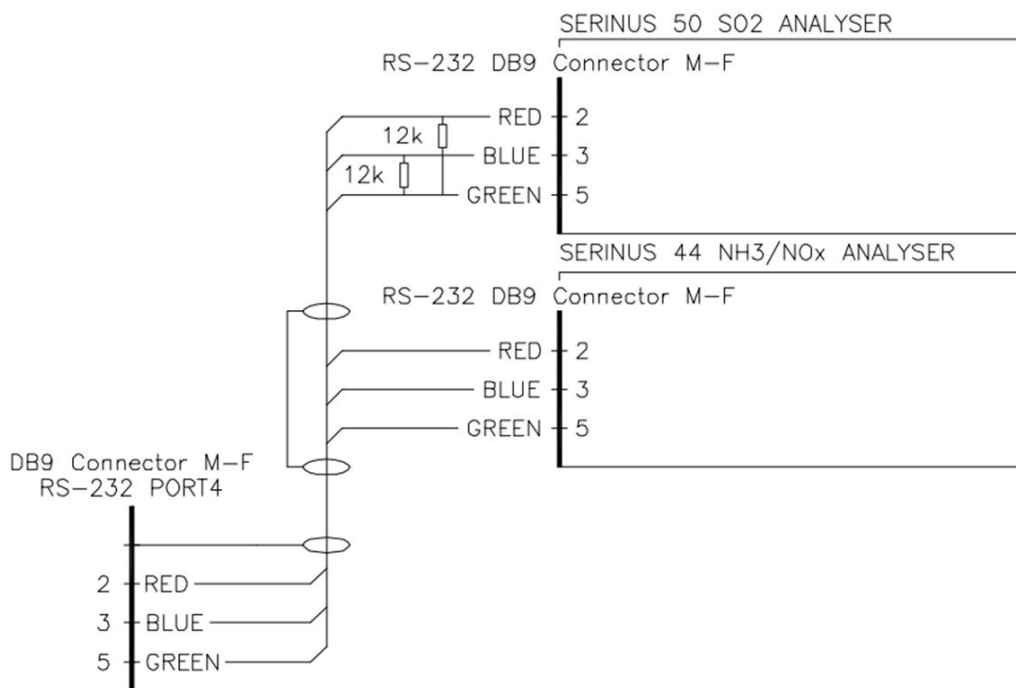

Figure 11 – Multidrop RS232 Cable Example

## 4.2 USB Communication

This is ideal for irregular connection to a laptop running Ecotech’s Airodis software to download logged data and remotely control the instrument. Due to the nature of USB, this is a less reliable permanent connection as external electrical noise can cause USB disconnection errors on a data logger.

**Note:** Only the Advanced protocol is supported for USB communication.

### 4.3 TCP/IP Network Communication (optional)

Instruments with the optional network port installed can be accessed using a TCP/IP connection. Figure 12 shows examples of some possible configurations for remote access.

#### Direct Connection

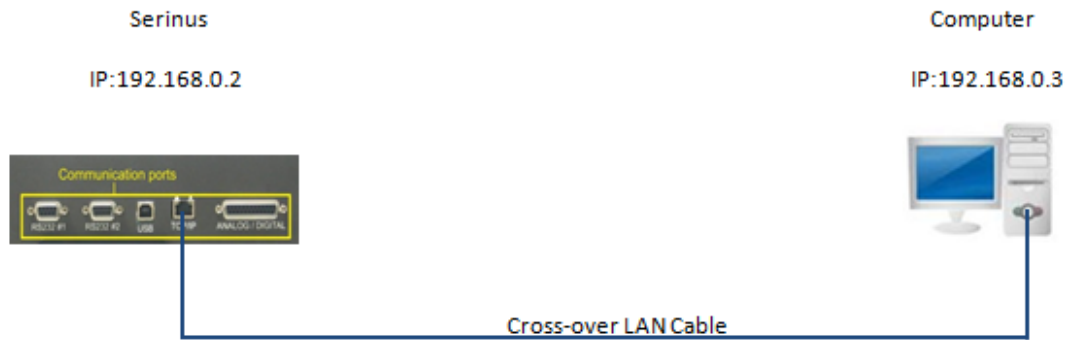

#### LAN

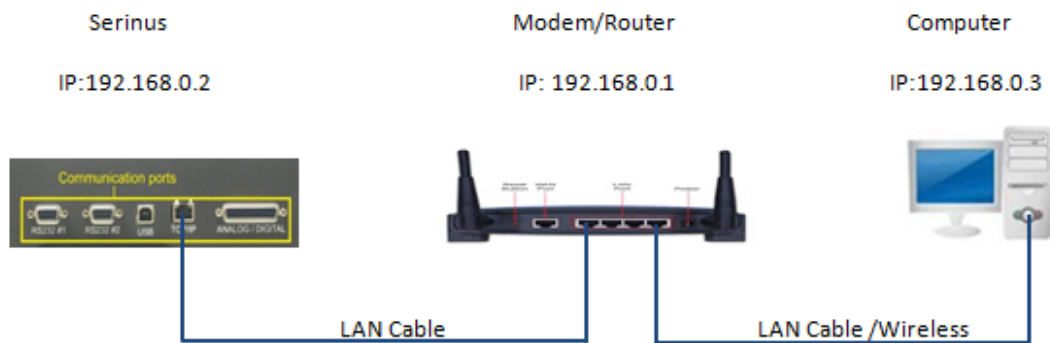

#### WAN

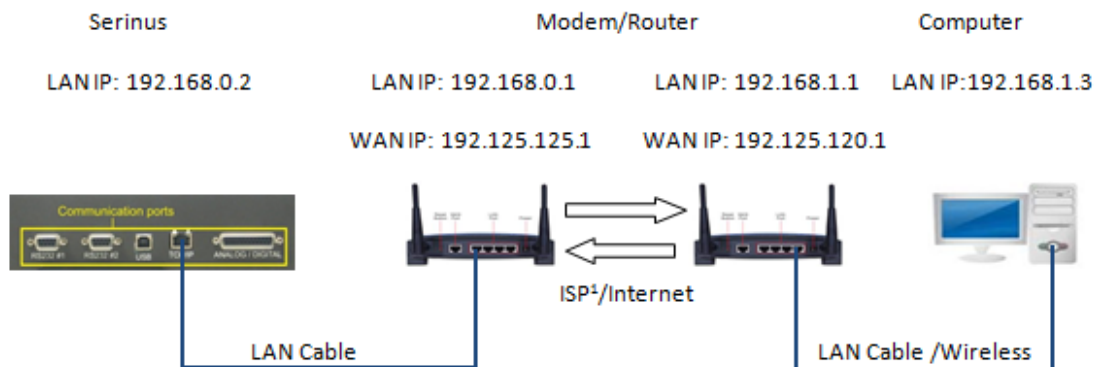

<sup>1</sup> ISP: Internet Service Provider

**Figure 12 – Example of Typical Network Setups**

**Note:** In Figure 12 all the IP addresses are taken as an example. The WAN IP addresses are normally provided by your ISP. Whereas, the LAN IP addresses can be set manually to any range which is within the subnet of the Modem/Router/switch.

Use a cross-over LAN cable to connect the instrument directly to a computer, or a standard LAN cable for connection to a Modem/Router/Switch as shown in Figure 12. The computer could be connected to the Modem/Router using either CAT5 cable or a wireless connection, but the instrument must be connected using CAT5/6 cable.

### 4.3.1 Network Setup

Below is an example of how to setup the network.

1. Open - **Main Menu** → **Communications Menu** → **Network Menu**.
2. Select - **Protocol** → **Advanced** - Accept.
3. Select - **Start-up Mode** → **Set IP** - Accept.
4. Edit - **IP Address** - (Change the IP address to the address you wish to use within the Modem/Router/switch subnet).
5. Edit - **Netmask** - (Change the Netmask to the setup specified by the Modem/Router).
6. Edit - **Gateway** - (Change the Gateway to the setup specified by the Modem/Router).

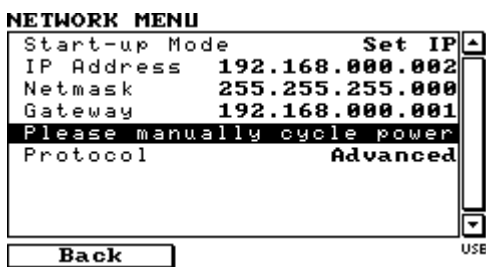

Figure 13 – Example of Network Menu Setup

7. Once completed, use the power switch on the rear of the instrument to turn the power Off. Please leave the instrument off for 10 seconds before turning the power back ON.

**Note:** Manually perform a hardware power cycle every time the IP address is changed for it to take affect.

### 4.3.2 Port Forwarding on Remote Modem/Router Setup

When using the network port to connect to the router / modem with NAT enabled, you will need to add IP mapping to ensure that data is forwarded through to the desired port. This is known as port forwarding. To set-up the port for the instrument, you will need to go into the modem/router configuration. Normally, you will see the port forwarding setup under Port Forwarding, NAT or Port Mapping menu. Below is an example port forwarding setup.

The default port for the Serinus range of instruments is 32783. The destination address is the instrument IP address setup in the **Network Menu**.



Item	Protocol	Incoming Address	Incoming Port	Destination Address	Destination Port
1	tcp	0.0.0.0	32783 - 32783	192.168.0.2	32783 - 32783

**Figure 14 – Port Forwarding Example**

### 4.3.3 Setup Airodis to Communicate with Serinus

#### LAN

Below is an example of Airodis setup for a LAN network. Ensure the IP address is set to the same as on the instrument **Network Menu**.

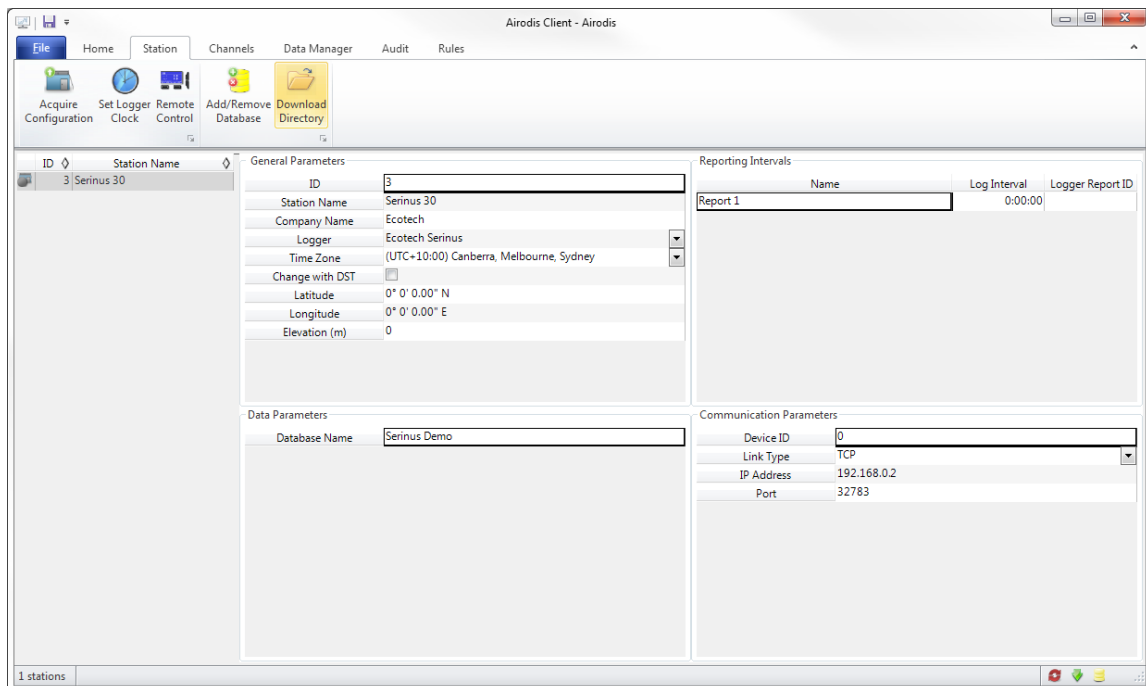

**Figure 15 – LAN Network Set-Up (Airodis)**

## WAN

Below is an example of Airodis setup for a WAN network. Ensure the IP address is set the same as on the remote modem/router.

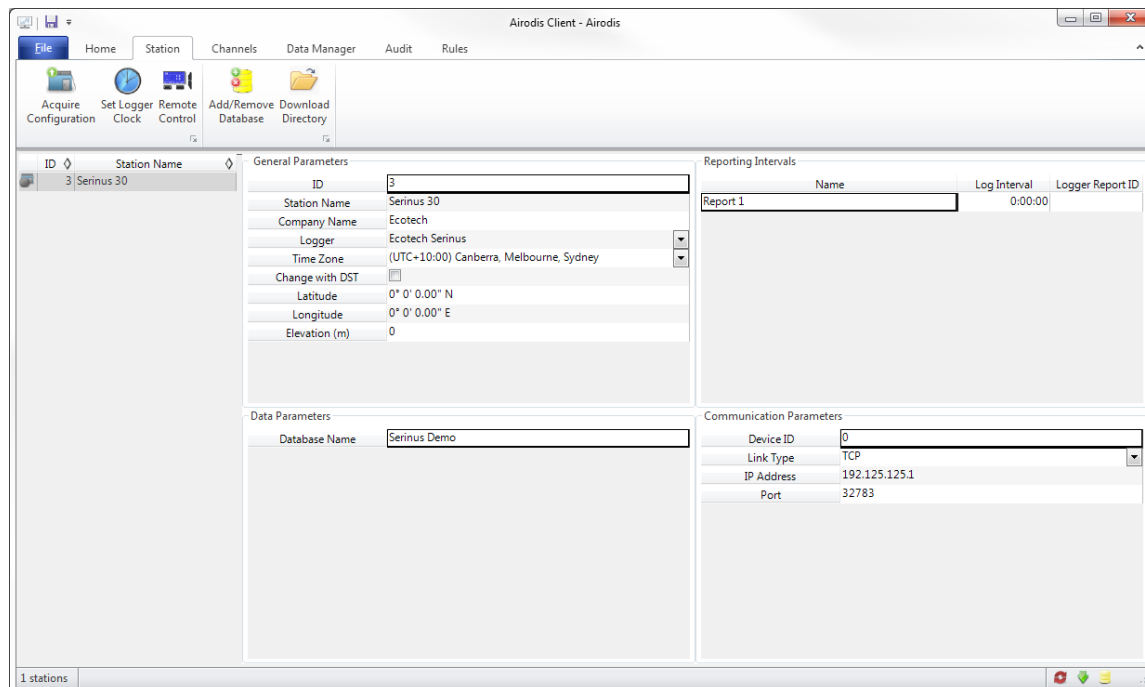

Figure 16 – WAN Network Set-Up (Airodis)

## 4.4 Digital/Analog Communication

The 25 Pin analog/digital port on the rear of the instrument sends and receives analog/digital signals to other devices. These signals are commonly used to activate gas calibrators or for warning alarms.

### 4.4.1 Analog Outputs

The instrument is equipped with one to three analog outputs that can be set to provide either voltage (0-5V, 0.25-5V, 0.5-5V, 0-10V) or current (0-20, 2-20, 4-20 mA). The analog outputs are tied to specific instrument measurements, depending on the instrument type.

For 0-10V analog output operation, set the output type to current and move the jumpers (JP3) on the rear panel PCA to 0-10V (refer to Figure 17).

Table 4 – Analog Outputs

Analyser	Output 1	Output 2	Output 3
S10	O <sub>3</sub>	N/A	N/A
S30	CO	CO <sub>2</sub> [optional]	N/A
S40	NO	NO <sub>x</sub>	NO <sub>2</sub>
S44	NO	NH <sub>3</sub>	NO <sub>2</sub>

Analyser	Output 1	Output 2	Output 3
S50	SO <sub>2</sub>	N/A	N/A
S51	SO <sub>2</sub>	H <sub>2</sub> S	N/A
S55	H <sub>2</sub> S	N/A	N/A
S56	TS	N/A	N/A
S57	TRS	N/A	N/A
S60	NO <sub>2</sub>	N/A	N/A
Serinus Cal 3000	N/A	O <sub>3</sub>	N/A

#### 4.4.1.1 Analog Outputs Voltage Calibration

##### Equipment Required

- Multimeter (set to volts)
- Male 25 pin connector with cable

##### Procedure

1. Open - **Main Menu** → **Communications Menu** → **Analog Output Menu** (refer to Section 3.4.25).
2. Select - **Output Mode** → **Voltage**.
3. Connect a multimeter (using an appropriate adaptor or probes on the multimeter) to the ground (pin 24) and the relevant output pin (pin 10).
4. Edit - **0.5V Calibration** - (until the multimeter reads  $0.500 \pm 0.002$ ) - Accept.
5. Edit - **5.0V Calibration** - (until the multimeter reads  $5.00 \pm 0.002$ ) - Accept.

#### 4.4.1.2 Analog Outputs Current Calibration

##### Equipment Required

- Multimeter (set to mA)
- Male 25 pin connector with cable

##### Procedure

1. Open - **Main Menu** → **Communications Menu** → **Analog Output Menu** (refer to Section 3.4.25).
2. Select - **Output Mode** → **Current**.
3. Connect a multimeter (using an appropriate adaptor or probes on the multimeter) to the ground (pin 24) and the relevant output pin (pin 10).
4. Edit - **4mA Calibration** - (until the multimeter reads  $4\text{mA} \pm 0.01$ ) - Accept.
5. Edit - **20mA Calibration** - (until the multimeter reads  $20\text{mA} \pm 0.01$ ) - Accept.

### 4.4.2 Analog Inputs

The instrument is also equipped with three analog inputs with resolution of 15 bits plus polarity, accepting a voltage between 0-5V. These go directly to the microprocessor and should be protected to ensure static/high voltage does damage the main controller PCA (instrument warranty does not cover damage from external inputs).

### 4.4.3 Digital Status Inputs

The instrument is equipped with eight logic level inputs for the external control of the instrument such as Zero or Span sequences. Each input has a terminating resistor which can be either PULL UP or PULL DOWN. This is set using the jumper JP1 on the back panel PCA (refer to Figure 17).

### 4.4.4 Digital Status Outputs

The instrument is equipped with eight open collector outputs which will convey instrument status condition warning alarms such as no flow, sample mode, etc. Two of the digital outputs can be set so that there is +5V and +12V available on the 25 pin connector for control purposes, instead of digital outputs 0 and 1.

In the default jumper locations (refer to Figure 10) these two outputs will function normally as open collector outputs. If moved to the position closer to the 25 pin connector then the DO 0 will supply +12V and DO 1 will supply +5V.

The +12V and +5V supplies are limited to about 100mA each.

Each digital output is limited to a maximum of 400mA. The total combined currents should not exceed 2A.

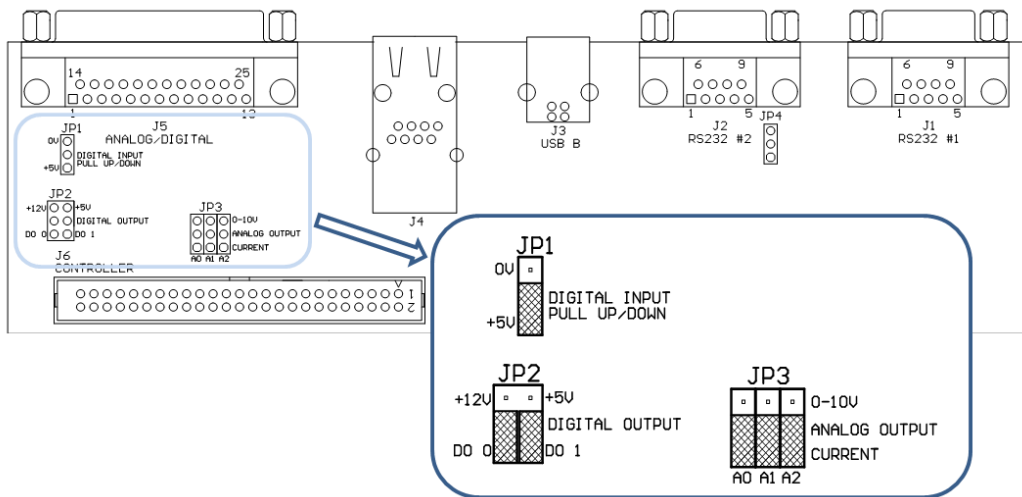
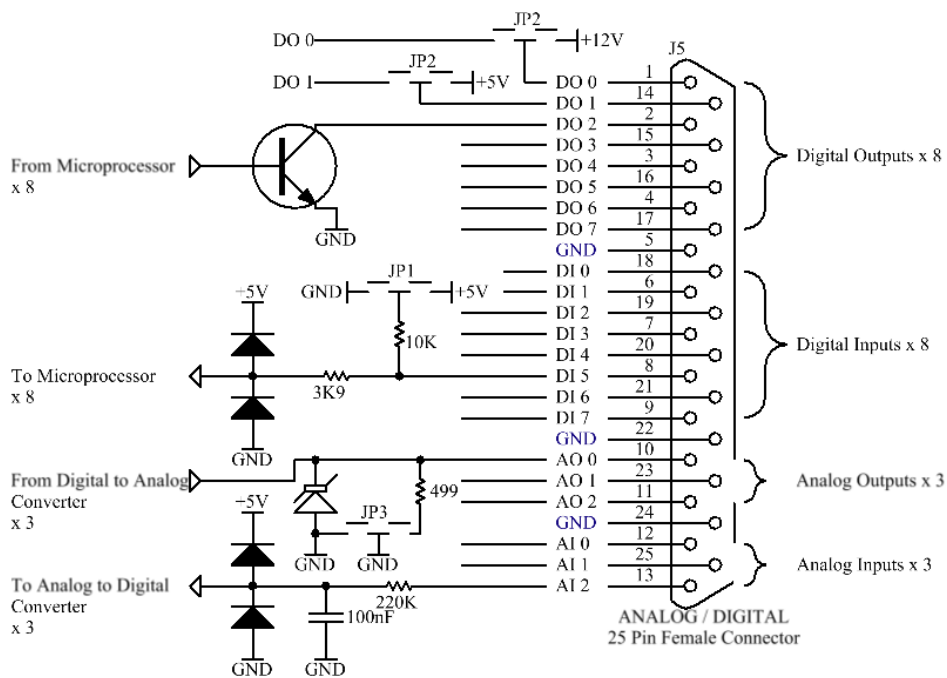

Figure 17 – 25 Pin Rear Panel PCA (Default Jumpers Highlighted)



**Figure 18 – External 25 pin I/O Individual Pin Descriptions**



**CAUTION**

The analog and digital inputs and outputs are rated to CAT I. Exceeding 12VDC or drawing greater than 400mA on a single output or a total greater than 2A across the eight outputs can permanently damage the instrument and void the warranty.

## 4.5 Logging Data

When the user receives the instrument from the factory it will have a default set of parameters already setup in the internal data logger. These select few parameters have been chosen for their relevance in assisting in troubleshooting the instrument.

### 4.5.1 Configure Instrument Internal Logging

In order to log data you must first specify a data logging interval. This is how often data will be logged to the USB memory stick. You can log a maximum of 12 parameters. These parameters can be selected by name or by parameter number using the parameter list as a reference (refer to Table 19).

#### Procedure

1. Open - **Main Menu** → **Communications Menu** → **Data Logging Menu** (refer to Section 3.4.22).
2. Select - **Data Log Interval** (adjust to the desired value).

3. Select - **Data Log Setup –Numeric** (select the parameter numbers you wish to log) **or** Select - **Data Log Setup –Text** (select the names of the parameters you wish to log).

---

## 4.6 Using Airodis Software to Download Data

---

### 4.6.1 Connecting the Instrument to Your PC

The instrument can communicate with a PC using RS-232 (Serial), TCP/IP (Network), Bluetooth or USB. Serial, Bluetooth and network communications do not require additional drivers. If you wish to connect using a USB cable, the driver must first be installed.

#### 4.6.1.1 Connecting Over USB

If you wish to connect using USB, you will need to first install the Serinus USB driver.

Power on the instrument and connect it to your PC with a USB cable. You should receive a prompt if the driver needs to be installed. If not, open Device Manager (Under “System” in Control Panel), find the device and select “Update Driver Software”.

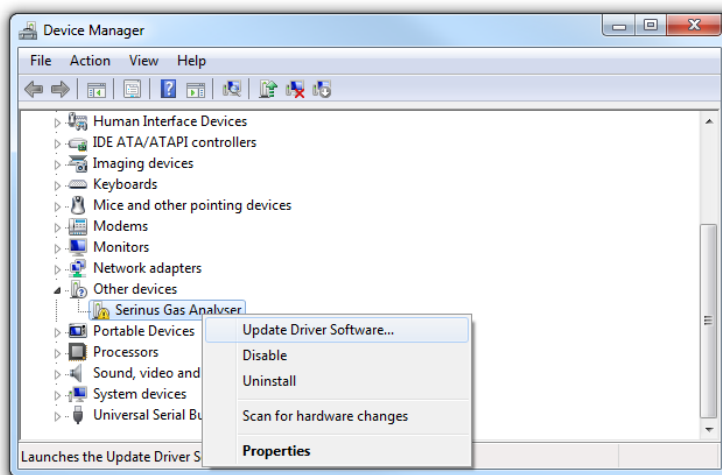

**Figure 19 – Installing Driver Software (Device Manager)**

When prompted where to search for the driver, select “**Browse my computer for driver software**”.

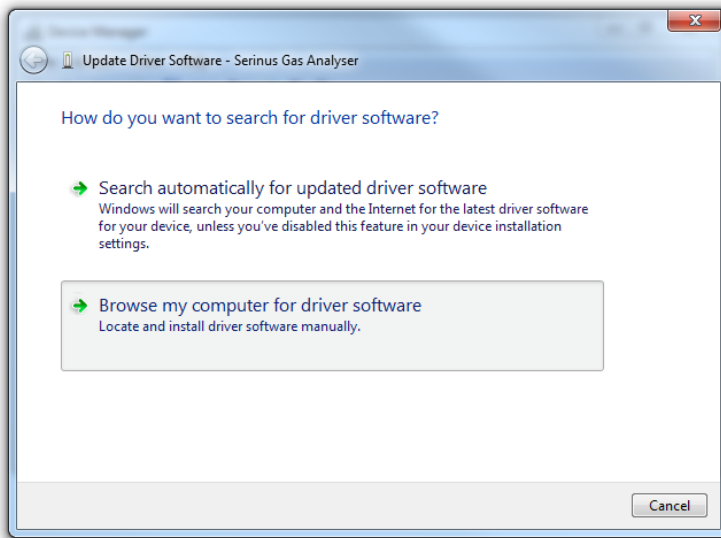

**Figure 20 – Update Driver Popup**

The Serinus USB driver is located on the green Ecotech resources USB stick under “\Drivers\Ecotech Analyser”. Select this directory and click **Next**.

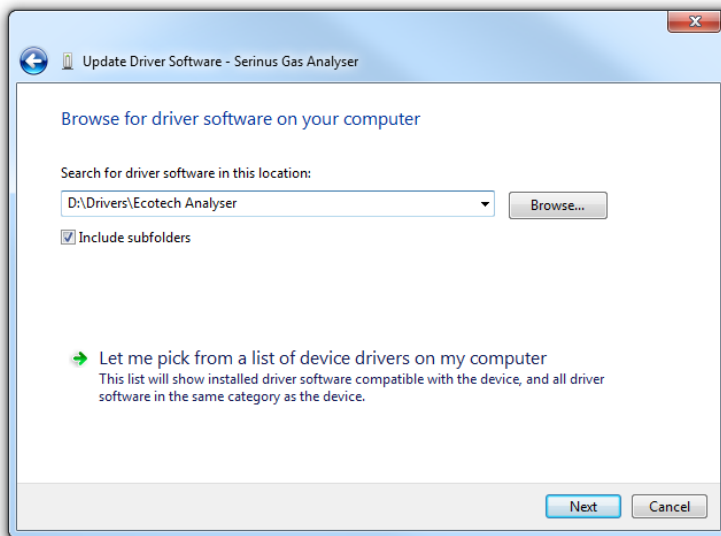

**Figure 21 – Update Driver Popup (Directory Location)**

If you receive a confirmation prompt to install the driver, select **Install**.

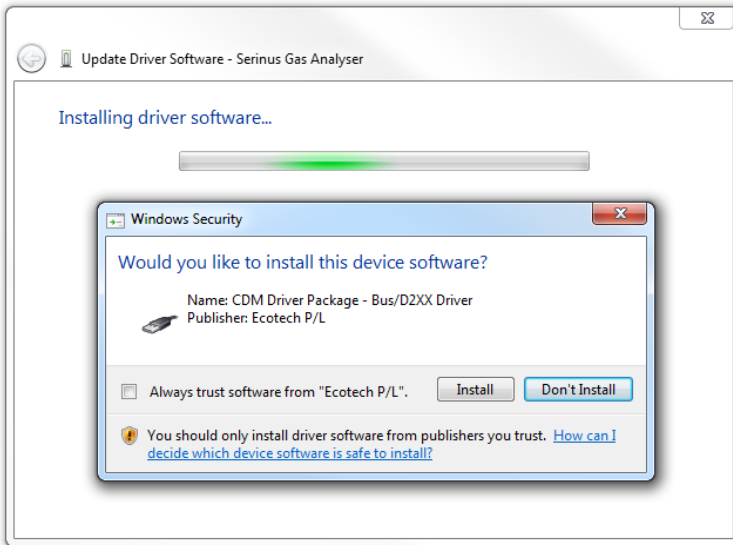

**Figure 22 – Installing Driver Confirmation Prompt**

If everything went smoothly, Windows will inform you that the driver was successfully installed.

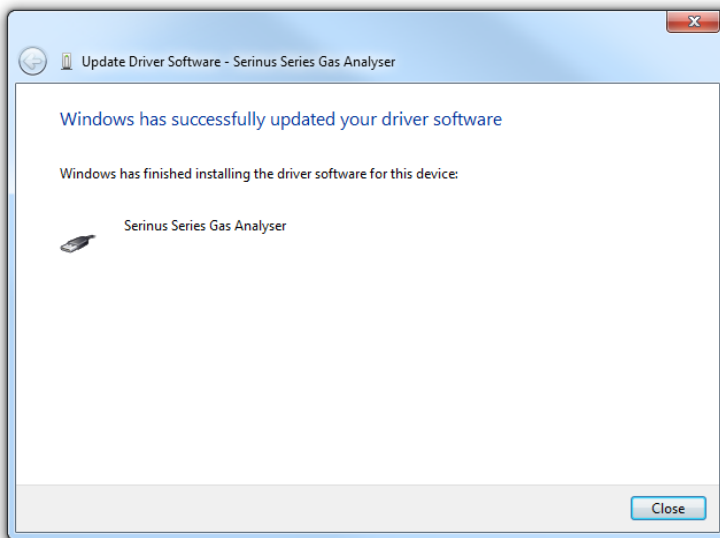

**Figure 23 – Successful Driver Installation**

#### 4.6.1.2 Connecting Over Serial (RS-232)

The following steps outline how to setup the instrument for connection to a PC or datalogger (refer to Section 3.4.23).

#### Procedure

1. Open - **Main Menu** → **Communication Menu** → **Serial Communication Menu**.
2. Determine which RS232 Port you are physically making the connection with. Remember, multidrop is only supported on RS232 #2.
3. Select – **Baudrate** → **38400** - Accept (Set an appropriate baud rate, default is 38400).



4. Select - **Protocol** → **Advanced** - Accept.

If you are running Airodis in a multidrop configuration, ensure that the **Serial ID** is unique for each instrument on the chain.

#### 4.6.1.3 Connecting Over Network (TCP/IP)

The following steps outline how to setup the instrument for connection to a PC or datalogger (refer to Section 3.4.28).

##### **Procedure**

1. Open - **Main Menu** → **Communication Menu** → **Network Menu**.
2. Select - **Protocol** → **Advanced** - Accept.
3. Select - **Start-up Mode** → **Set IP** - Accept.
4. Assign a unique static IP address to the instrument.
5. Reboot the instrument by cycling the power.

#### 4.6.2 Installing Airodis

The user can download data from the instrument using either a full retail (paid) version of Airodis or with the demo version which is included on the green Ecotech resources USB stick. The demo version has limited functionality, but will allow you to download and export data from up to three instruments. If you do not already have Airodis, this can be obtained from Ecotech:

**<http://www.airodis.com.au>**

The installer is straightforward: Ensure you install the correct version for your operating system. If you are running 64-bit windows, install the 64-bit (x64) version. Otherwise, install the 32-bit (x32) version.

#### 4.6.3 Configuring Airodis

1. Once installed, double click on the Airodis shortcut on the desktop to start Airodis Workspace Manager. You will be presented with the default workspace options. These will suffice for downloading data from the instrument.

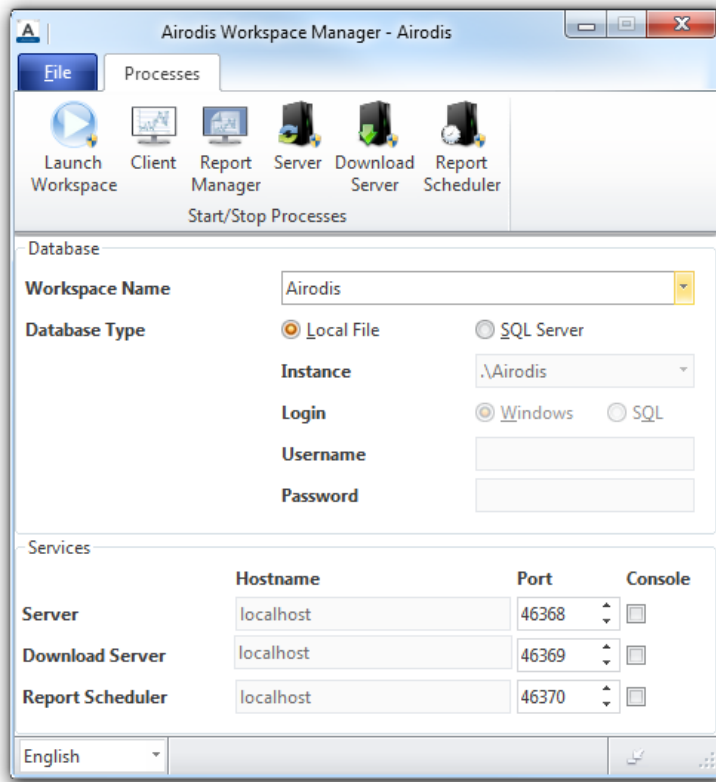

**Figure 24 – Airodis Workspace Manager**

2. Start the Client, Server and Download Server by single-clicking the toggle button for each. The client may prompt to register with Ecotech or install an update. Follow the prompts if it does.
3. Once the Client application has loaded, click **Home→Add Station→New Physical Station**.

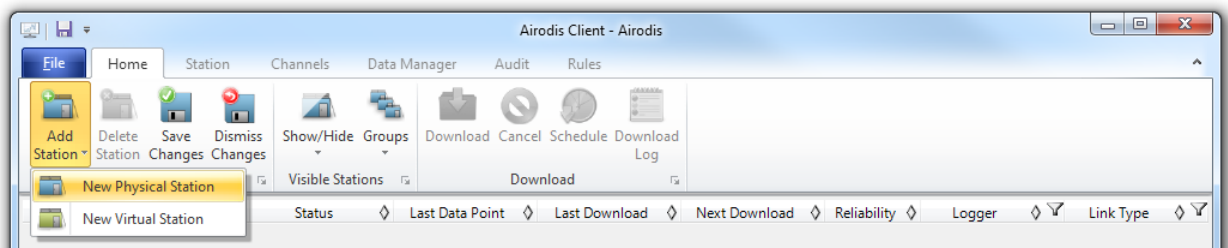

**Figure 25 – Adding a New Station**

4. This automatically brings you to the **Station** tab on the ribbon. Enter the communication details to connect to the instrument.

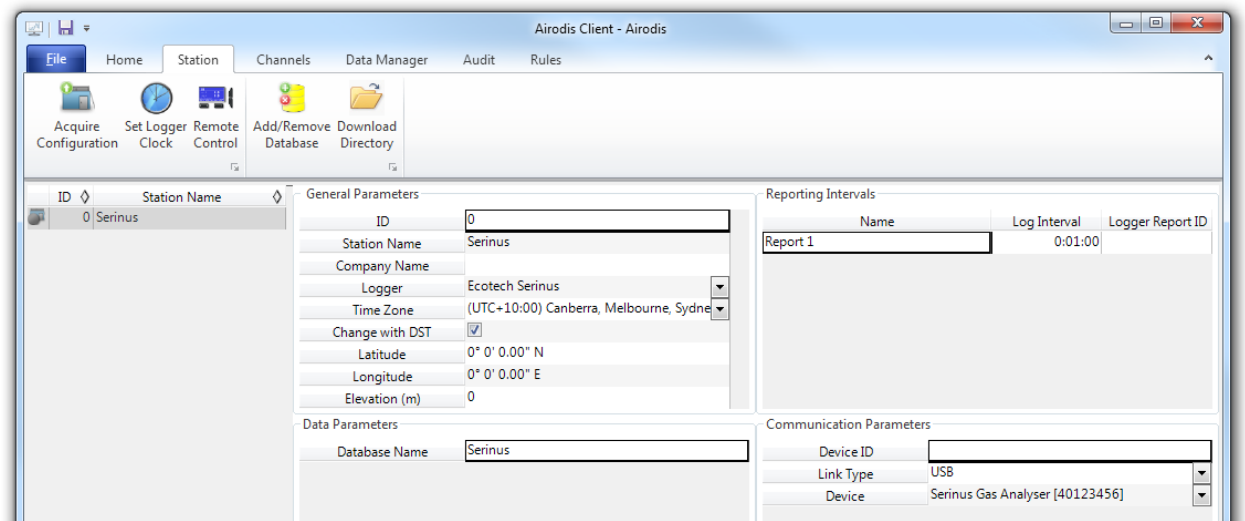

**Figure 26 – New Station Connection**

**Table 5 – New Station Setup**

Property	Description
Station Name	The name of the station. If you have other loggers, the name is used to distinguish them.
Logger	Set this to “Ecotech Serinus” when downloading from any Serinus series instrument. This will communicate with the instrument on the <b>Advanced</b> protocol. If using a network or serial connection, ensure that the Advanced protocol has also been selected on the instrument itself.
Time Zone	Set this to the time zone that the instrument is located in.
DST	Enable this option if you plan on changing the clock on the instrument with daylight savings. Leave this disabled if the clock does not shift during DST. The instrument will need to be adjusted manually for DST – it will not happen automatically.
Database Name	This is the name to be used for the table in the SQL database containing this station’s data. It must be unique for each station.
Device ID	Enter the <b>Serial ID</b> of the instrument .If you are not using multidrop; this can be set to “0” or left blank.
Link Type	Select the type of connection used to connect to the instrument. Different properties will appear depending on the link type selected. Make these align with t with those of the instrument.
Log Interval	This needs to be the same as the <b>Data Log Interval</b> setting on the instrument.

**Note:** The available fields for communication parameters will change when you change the link type. You will need to set the communication parameters that have been defined on the instrument.

- Once the station has been created, save the station by clicking the Save shortcut icon or **File→Save**.

- Click Acquire Configuration. This will probe the instrument for a channel list. After a few seconds, the channel list should be visible in the Channels tab.

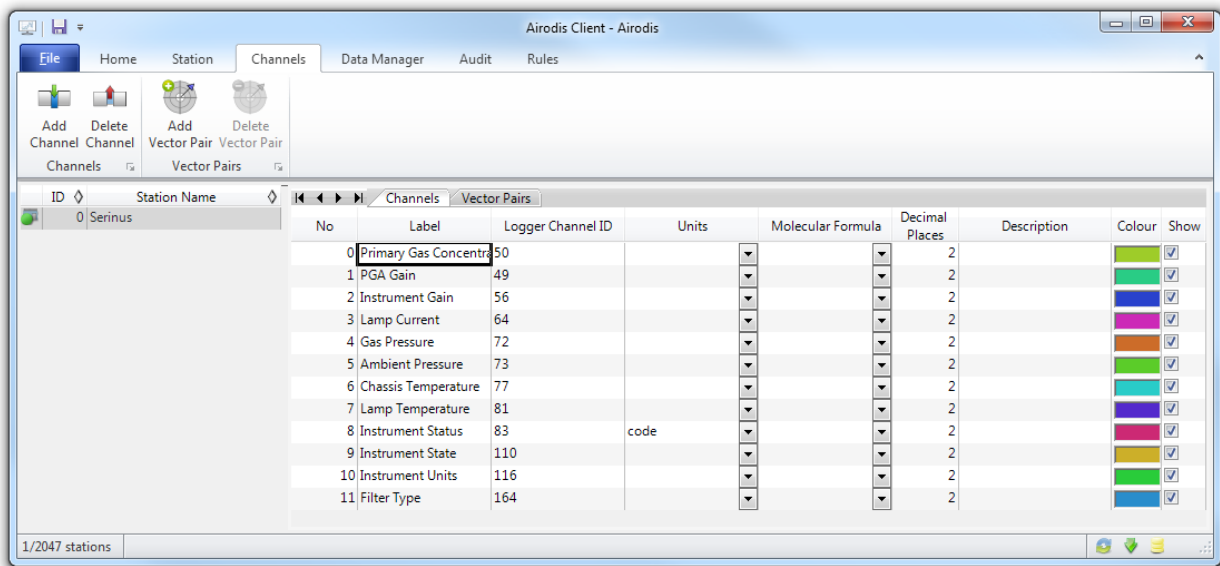

Figure 27 – Station Configuration

**Note:** If there was an error connecting to the instrument, a red dot will appear next to the station name in the station list (on the far left hand side). Hovering over the red dot will present you with an error message (refer to Figure 28).

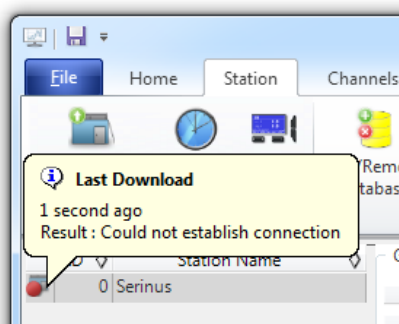
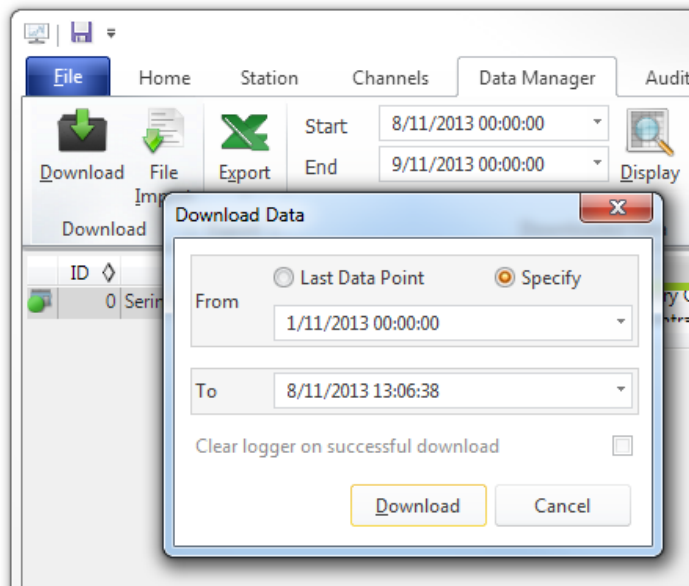

Figure 28 – Error Status Notification

- Select the Data Manager tab, click download. The Download Data window will appear. Select the appropriate time period that you wish to download and click Download.



**Figure 29 – Downloading Data**

8. The status of the download will appear in the bottom-left corner of the window. You can also monitor the status of the download from the Home tab.

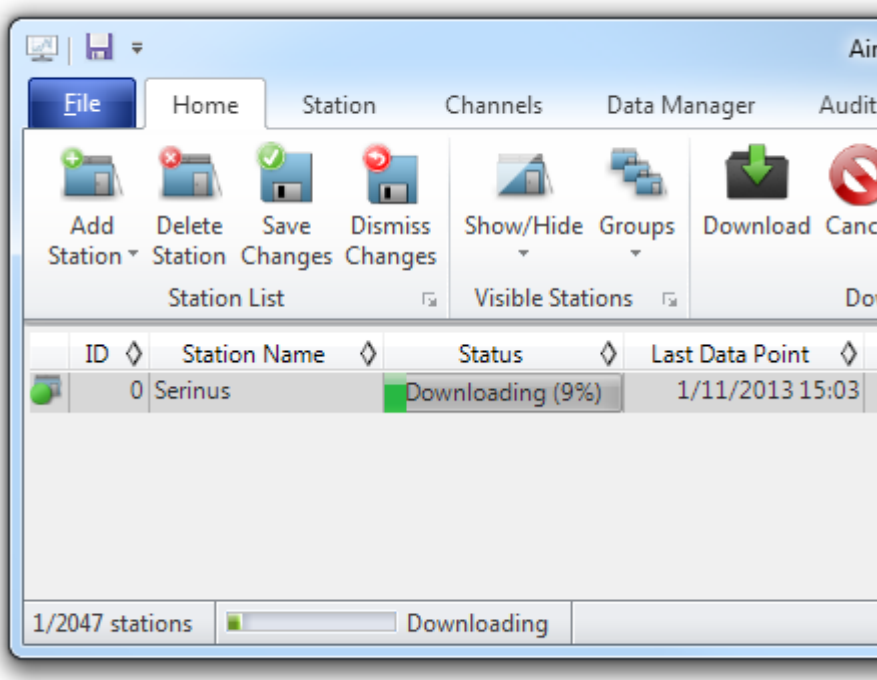

**Figure 30 – Download Data Status**

9. Data will become available in the data manager as it is downloaded. You can load data for a date range by entering the start and end dates and clicking Display. The selected data will be loaded into the data manager.

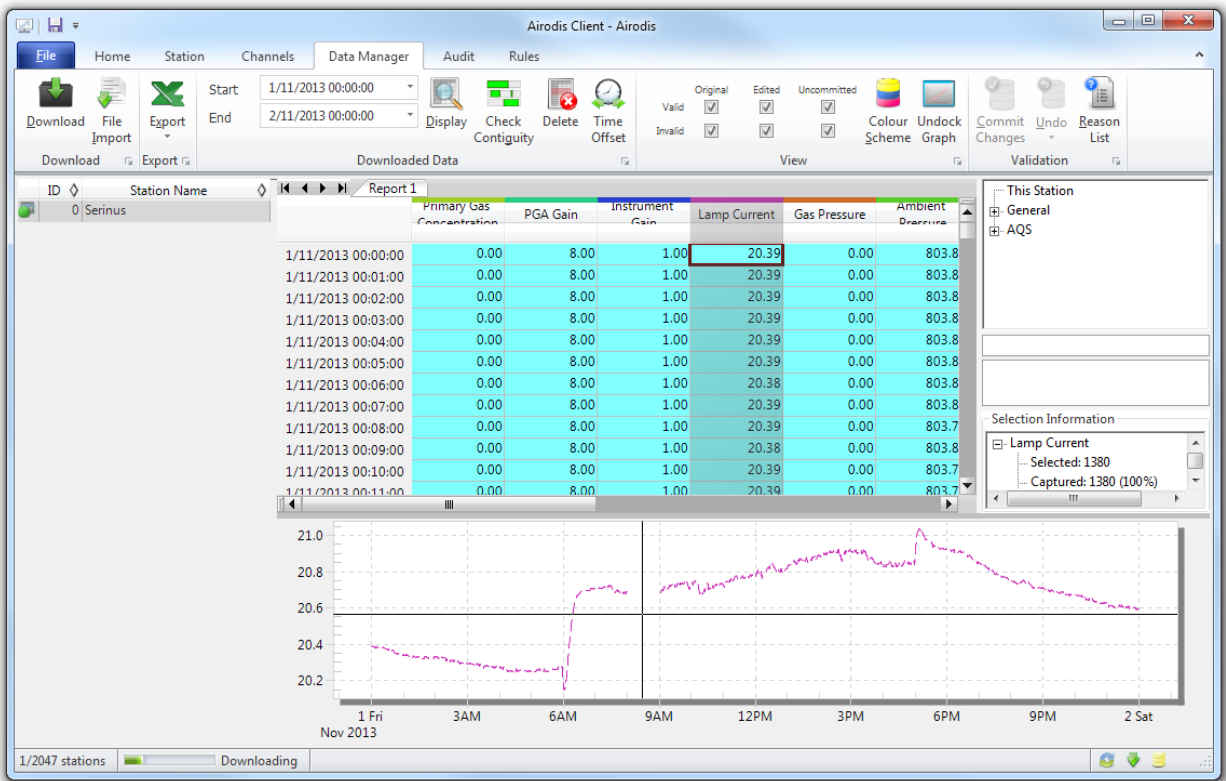

Figure 31 – Data Visibility

10. Data can be exported by clicking the Export function. This will allow you to save your data in CSV format, which can be loaded into another program such as Microsoft Excel. It is also possible to copy/paste (Ctrl + C / Ctrl + V) data directly from the Airodis data manager.

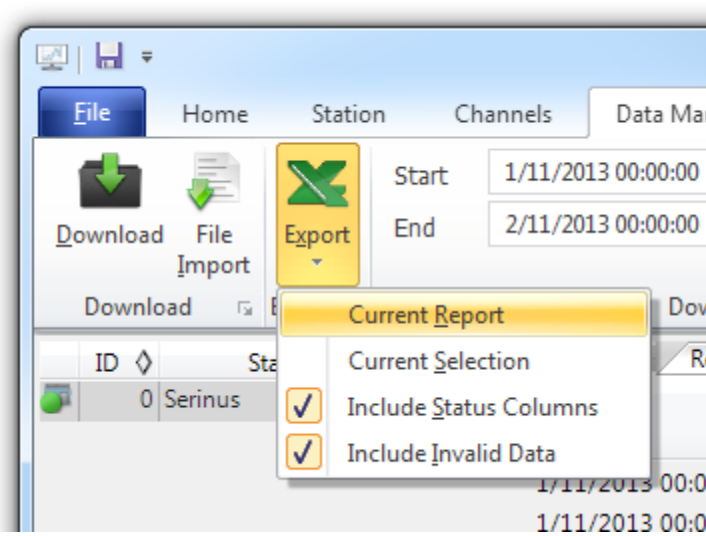
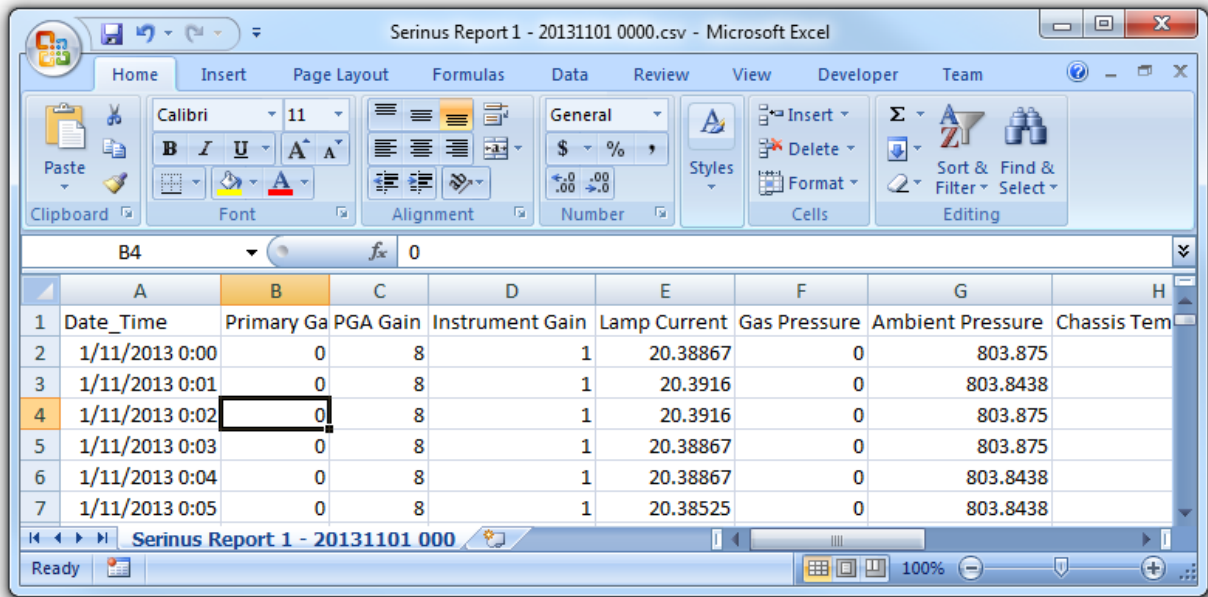

Figure 32 – Exporting Data

11. That's it! The data has been downloaded from the instrument and exported to a standard CSV file.



	A	B	C	D	E	F	G	H
1	Date_Time	Primary Ga	PGA Gain	Instrument Gain	Lamp Current	Gas Pressure	Ambient Pressure	Chassis Tem
2	1/11/2013 0:00	0	8	1	20.38867	0	803.875	
3	1/11/2013 0:01	0	8	1	20.3916	0	803.8438	
4	1/11/2013 0:02	0	8	1	20.3916	0	803.875	
5	1/11/2013 0:03	0	8	1	20.38867	0	803.875	
6	1/11/2013 0:04	0	8	1	20.38867	0	803.8438	
7	1/11/2013 0:05	0	8	1	20.38525	0	803.8438	

**Figure 33 – Data Download Complete**

## 4.7 Serinus Remote App/Bluetooth

The Serinus Remote Application allows for any Android device (Tablet or Smartphone) to connect to an instrument.

The Serinus Remote Application allows the user to:

- Completely control the instrument using a remote screen displayed on the device.
- Download logged data and take snapshots of all the instrument parameters.
- Construct graphs from logged data or real time measurements.

### 4.7.1 Installation

The Serinus Remote Application can be found in the Google Play Store by searching for Ecotech or Serinus. Once found, choose to Install the application and Open to start the application.

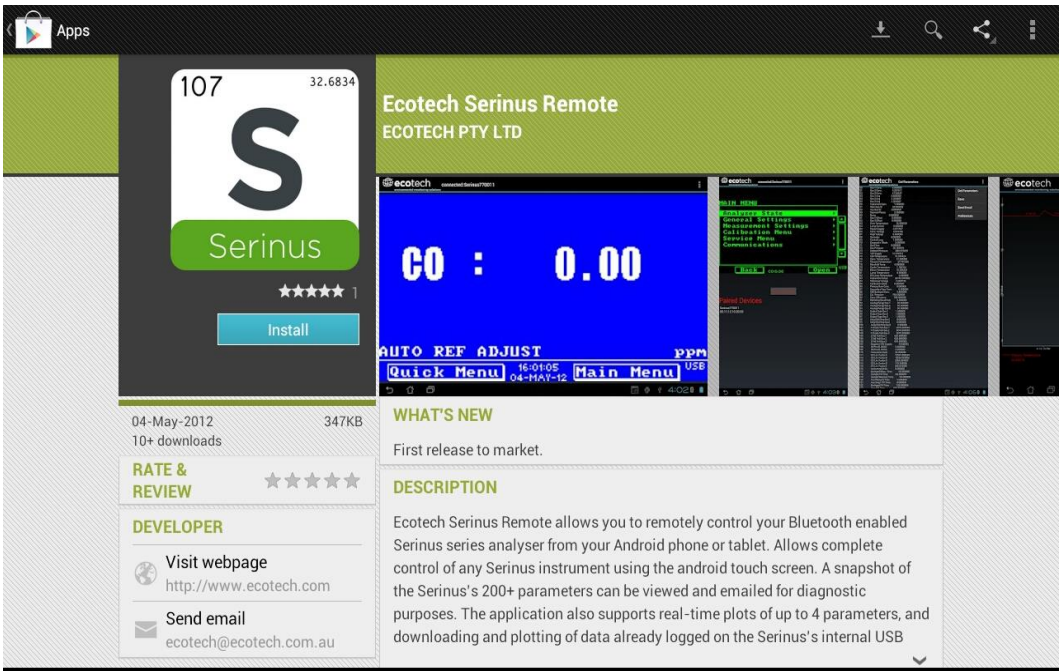

Figure 34 – Downloading the App from Google Play Store

**Note:** A menu containing additional features and functions can be accessed by entering the Options Menu (or similar) on your device. The location and format of this menu may vary.

#### 4.7.2 Connecting to the Instrument

##### Procedure

1. Open - **Main Menu** → **Communications Menu** → **Bluetooth Menu** (to find the Bluetooth ID and PIN) (refer to Section 3.4.29).
2. Touch the Scan Serinus Analysers button at the bottom of the screen.
3. Select the Analyser ID from either the Paired Devices or the Other Available.
4. Input the PIN (if prompted) and press OK (refer to Section 3.4.29).

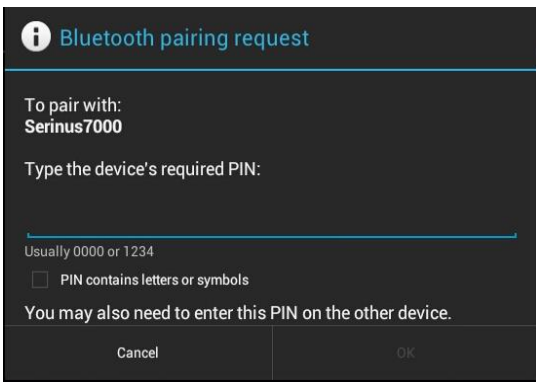

Figure 35 – Bluetooth Pairing Request



5. A screen shot of the instrument’s current screen should appear on your Smartphone or tablet. To disconnect press the back key/button on the device.

**Note:** Once the instrument has been paired with the device it will appear under “Paired Devices” and the PIN will not need to be entered again. Only one Bluetooth connection can be made to an instrument at any one time.

### 4.7.3 Instrument Control

Once connected the user has full control of the instrument. The range for remote control depends on the device’s Bluetooth capabilities and any intervening obstructions, but is usually up to 30 meters.

#### Remote Screen Operation

With the exception of the number pad, all button functions/actions can be performed by touching the screen. This includes the selection buttons and the scroll buttons. Touching any part of the screen where there is not already a button also enacts the functions of the scroll buttons.

#### Home Screen

Touching the upper half of the screen increases the contrast and touching the lower half of the screen decreases contrast on the real instrument.

#### Menus

Touching the upper or lower half of the screen allows the user to scroll up and down respectively.

#### Right-hand Section of the Screen

Swiping from right to left brings up the number pad for entering numbers (swipe from left to right to hide the number pad).

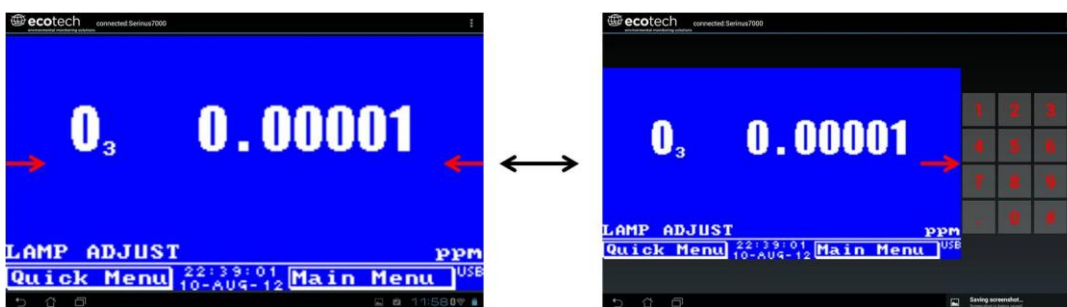

**Figure 36 – Showing or Hiding the NumPad**

#### Left-hand Section of the Screen

Swiping from left to right brings up a list of available analysers (swipe from right to left to hide the instrument list).

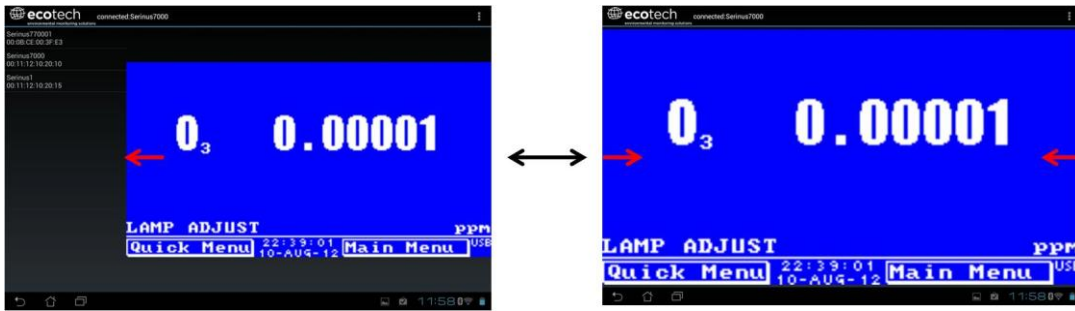

Figure 37 – Switching Analysers

## Back Button

This button will enable the user to return to the selection screen, allowing the user to connect to a different instrument.

## Options Menu

The Options Menu is accessed by the grey button in the top right corner of the screen or pressing the Menu Button, depending on your Android device.

Refresh	Refresh the display.
Show/Hide NumPad	Show or hide the number pad.
Real Time Plot	Refer to Section 4.7.4.
Download	Refer to Section 4.7.5.
Get Parameters	Refer to Section 4.7.6.
Preferences	Refer to Section 4.7.7.

### 4.7.4 Real-Time Plot

Allows the user to view real-time plotting of up to four parameters at the same time. The user can also scroll from left to right, top to bottom or zoom in and out on the plot by swiping/pinching.

Once the plot is zoomed or scrolled, it enters into Observer Mode, meaning that auto-scaling is suspended. Press at the top of the screen (where it says Observer Mode) to return to Normal Mode.

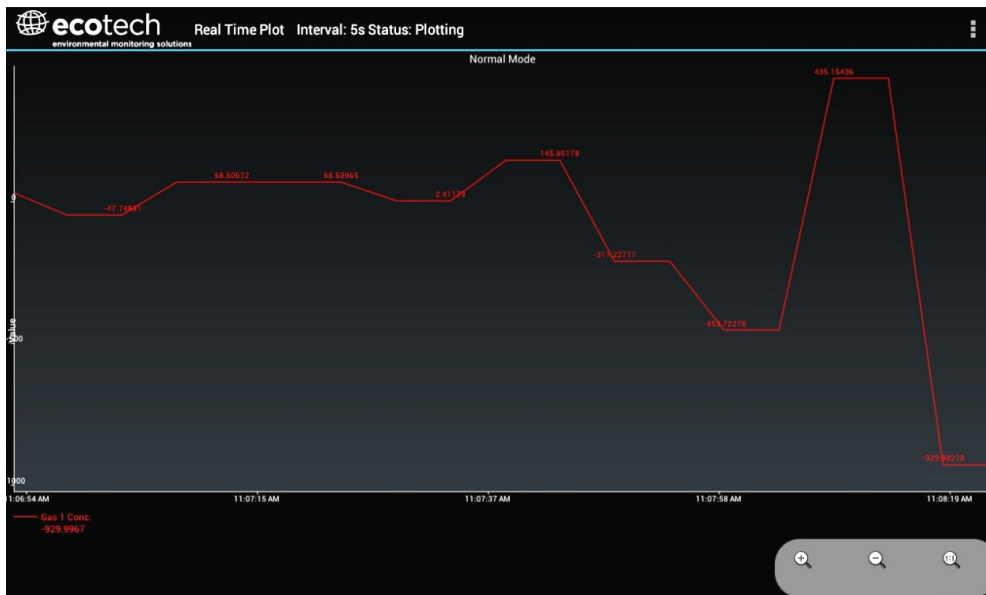

**Figure 38 – Real-Time Plot**

## Options Menu

The Options Menu is accessed by the grey button in the top right corner of the screen or pressing the menu button, depending on the Android device.

<b>Start</b>	Restarts graphing if it has been stopped and returns the graph to <b>Normal Mode</b> .
<b>Stop</b>	Stops collecting data. In this mode you can scroll the display without going into <b>Observer Mode</b> , because the system has no data collection to suspend. It is necessary to “Stop” data collection to set the interval.
<b>Clear</b>	Clears the window and restarts the graphing.
<b>Save</b>	Saves an image of the graph and accompanying data in the location specified in preferences (refer to Section 4.7.7). The user will also be asked whether they want to send the file and data via email. When saving the data, you can choose to <b>Save All Data</b> or <b>Customise</b> the length of the data by entering a time between five minutes and six hours. Only the data from the start of collection to that limit will be saved (although the plot will still appear exactly as it does on the screen).
<b>Set Interval</b>	While data collection is stopped, the user can specify the time intervals between collections.

### 4.7.5 Download

Download logged data from the USB memory stick inside the instrument. All data logged by the instrument to the USB memory stick over the period of time specified will be collected. Due to the slow connection speed of Bluetooth, this should only be used for relatively short sections of data. Downloading one days' worth of one minute data is likely to take a couple of minutes.

### Options Menu

<b>Save</b>	Generates a filename based on the start and end date/time specified. It saves the downloaded data in the location specified in preferences and asks to send the saved comma separated text file (.csv) as an attachment to an email. This file format does not include the parameter headings, just the values.
<b>Send E-Mail</b>	Sends an email with the parameter data in the body of the email, formatted as displayed (this includes the parameter name and the values).
<b>Plot</b>	Graphs the data that has been downloaded. The user is prompted to select which parameters to plot based on the parameters that were being logged (refer to Figure 36)
<b>Preferences</b>	Refer to Section 4.7.7.

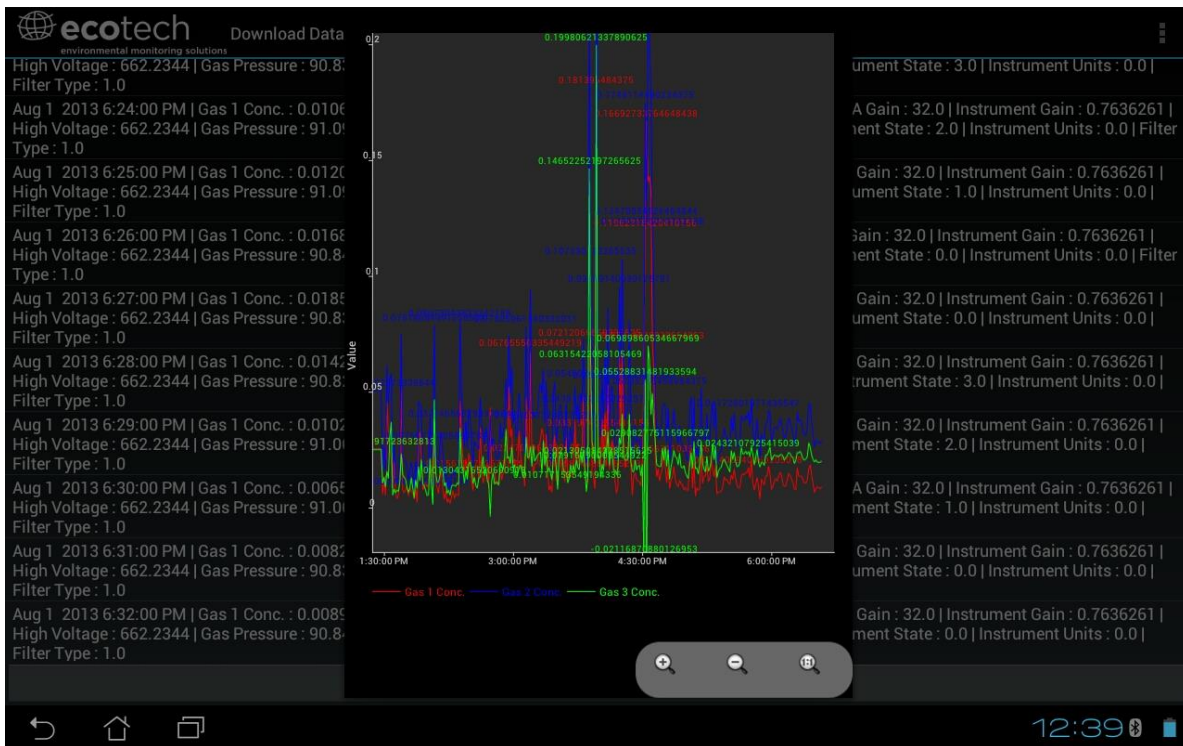

Figure 39 – Plot of Downloaded Data

### 4.7.6 Get Parameters

Download a list of parameters and corresponding values directly from the instrument. This list of parameters is a snap shot of the current instrument state and is very helpful in diagnosing any problems with the instrument.

## Options Menu

<b>Get Parameters</b>	Refreshes the parameter list display.
<b>Save</b>	Generates a filename from the current date and time. It saves the parameter data in the location specified in preferences and asks to send the saved text file as an attachment to an email.
<b>Send E-Mail</b>	Sends an email with the parameter data in the body of the email, formatted as displayed.
<b>Preferences</b>	Refer to Section 4.7.7.

### 4.7.7 Preferences

The Preferences Menu allows the operator to adjust the directory settings, logged data format and the colour scheme settings. It can be accessed through the Options Menu in most windows.

#### Directory Settings

The operator can specify/select where to save the parameter lists, logged data and real time plots.

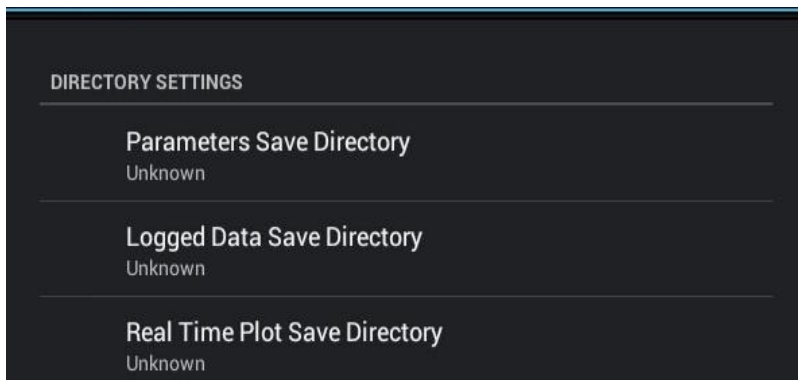

**Figure 40 – Directory Settings**

#### Logs Format

When downloading logged data, the parameters can be displayed on one line or each parameter on a separate line.

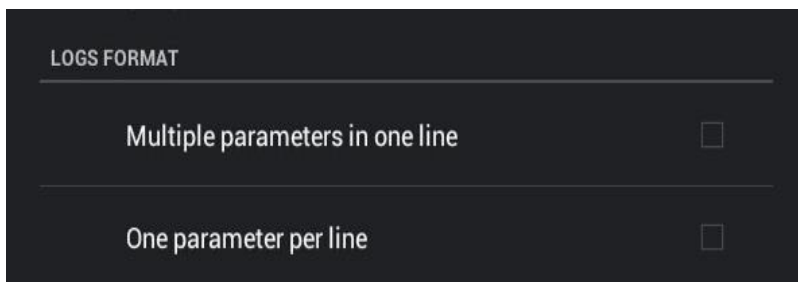

**Figure 41 – Logs Format**

## Colour Theme Settings

Allows the user to choose a colour scheme for the remote screen either Matrix, Classic, Emacs or Custom.

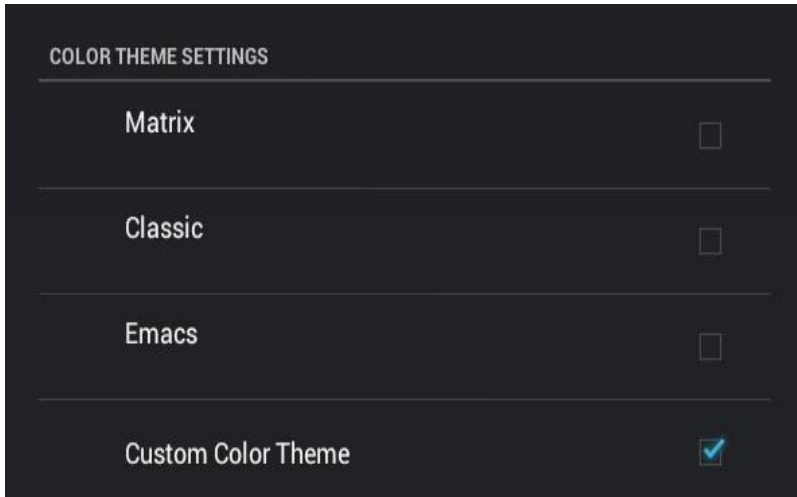

Figure 42 – Colour Theme Settings

## 5. Calibration

The following procedures describe how to calibrate the span and zero point for the instrument as well as giving a brief overview of the calibration system.

**Main Menu** → **Calibration Menu**, refer to Section 3.4.10 for information on menu items.

### 5.1 Overview

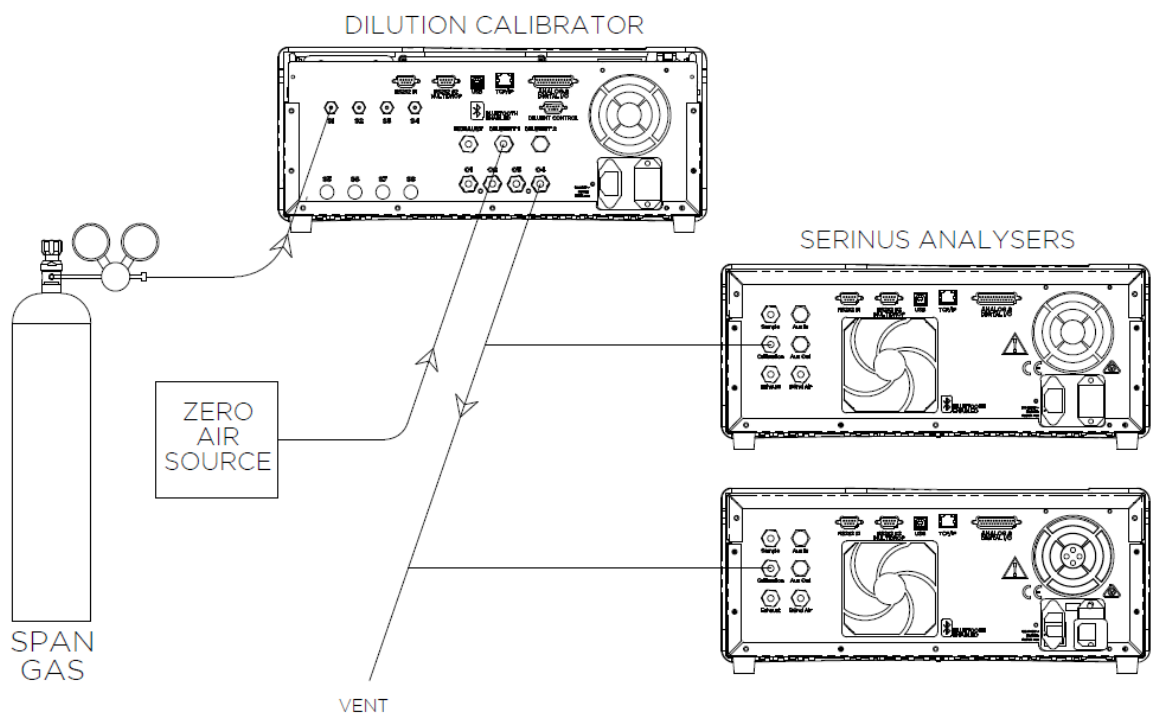

**Figure 43 – Example of a Calibration System**



#### CAUTION

All calibration gases **must** be supplied at ambient pressure to avoid damaging the instrument. If direct gas cylinder connection is required, high pressure Span/Zero options can be installed at time of ordering.

The calibration chapter consists of a:

- General discussion of calibration
- Description of the pressure calibration procedure
- Description of the Zero/Span precision check and calibration procedures

- Description of the multipoint precision check procedure

The Serinus 60 analyser is a precision measuring device which must be calibrated against a known source of NO<sub>2</sub>; within a certified gas cylinder.

There are several different types of checks/calibrations performed:

- Level 1 Calibration – A simplified two-point instrument calibration used when instrument linearity does not need to be checked or verified. This check is typically performed on a monthly basis. Adjustments to the instrument response can only be made when performing level 1 calibration.
- Level 2 Calibration – A simple check of the instrument's response. Level 2 checks may be performed using non-certified reference sources and are most often used as a performance monitoring tool. Commonly referred to as a precision check, the instrument must not be adjusted.
- Multipoint Precision Check – A series of points (typically covering zero and 5 up-scale span points) are supplied to the instrument. They should cover the instruments intended full scale measurement range. These precision checks are used to determine the linearity of the instrument response across its operating range.

In general terms, the calibration process includes the following steps:

1. Establish a reliable and stable calibrating source
2. Provide a satisfactory connection between the calibration source and the instrument
3. Perform a zero precision check or calibration
4. Calibrate the instrument against the NO<sub>2</sub> reference
5. Perform a multipoint precision check using the NO<sub>2</sub> reference. This determines the linear response of the instrument across the operating range.

Zero and span calibrations are frequently used to provide a two-point calibration or an indication of instrument stability and function.

A multipoint precision check is used to establish the relationship between instrument response and gas concentration over the instrument's full scale range.

**Note:** Zero calibrations are not recommended by Ecotech, but maybe be performed when specifically required by a user. Calibrating the zero tends to mask issues that should be addressed during maintenance/service.

Regulations generally require that the instrument be span calibrated against a certified calibration source any time:

- The instrument is moved.
- The instrument is serviced.
- The instrument's units are changed by the user between volumetric and gravimetric.
- Whenever the instrument characteristics may have changed.



Regulatory agencies establish the time intervals at which the instrument must be calibrated to ensure satisfactory data for their purposes.

---

## 5.2 Pressure Calibration

---

The pressure sensors are a vital component of the instrument operation and the pressure calibration should be checked on installation or whenever maintenance is performed.

A thorough leak check must be performed prior to performing a pressure calibration (refer to Section 6.3.6).

The pressure calibration can either be a two point calibration (one point under vacuum and another point at ambient pressure) or a single ambient point calibration when very minor adjustments are required.

**Note:** Ensure that the instrument has been running for at least one hour before any calibration is performed to ensure the instrument's stability. When performing a two point pressure calibration, it is advisable to perform the vacuum pressure calibration first.

### 5.2.1 Full Pressure Calibration

This section outlines how to perform a full pressure calibration. Using the required equipment follow the steps below to complete a full pressure calibration.

**Note:** This procedure is for firmware version 3.44.0001 and above. Ensure that the instrument has been running for at least one hour before the calibration is performed.

**Note:** Ensure units of measure are the same on both the barometer and instrument.

### Equipment Required

- Barometer
- Vacuum source

### Procedure

1. Disconnect all external tubing connected to the rear ports of the instrument.
2. Open - **Main Menu** → **Calibration Menu** → **Pressure Calibration Menu** - (read note) - OK.

**Note:** This action will place the valve sequencing on hold; normal sampling will be interrupted.

3. Edit - **Vacuum Set Pt.** - (Read displayed instructions) - OK.
4. Connect a barometer to the **Sample Port** (refer to Figure 5).
5. Connect a vacuum source to **Exhaust Port** (refer to Figure 5).
6. Wait 2-5 minutes and ensure the pressure reading on the barometer has dropped and is stable.
7. Enter the barometer reading into the instrument - Accept.
8. Read displayed instructions - OK.

- Turn off the vacuum source and disconnect the barometer from the **Sample Port**. Wait ~1 minutes for the pressure to equalise within the instrument.
- Disconnect the vacuum source from the **Exhaust Port**.
- Wait 2-5 minutes, enter the ambient barometer reading into the instrument - Accept.

**Note:** Both of the pressure sensors should now be displaying the current ambient pressure and they should be the same value within 3 torr of each other.

- Back - **Pressure Calibration Menu** - (read note) - OK.

### 5.2.2 Ambient Point Pressure Calibration

Full pressure calibrations are generally recommended, however it is possible to calibrate only the ambient point in cases where only a minor ambient pressure adjustment is required.

**Note:** Ensure that the instrument has been running for at least one hour before any calibration is performed to ensure the instrument's stability.

**Note:** Ensure units of measure are the same on both the barometer and instrument.

### Equipment Required

- Barometer

### Procedure

- Open - **Main Menu** → **Calibration Menu** → **Pressure Calibration Menu** - (read note) - OK.

**Note:** This action will place the valve sequence on hold; normal sampling will be interrupted.

- Edit - **Ambient Set Pt.** - (Read displayed instructions) - OK.
- Disconnect any external tubing connected to the rear ports of the instrument (**Sample Port**, **Calibration Port** and **Exhaust Port**).
- Wait 2-5 minutes and enter the ambient barometer reading into the instrument - Accept.



Figure 44 – Setting the Ambient Set Point

**Note:** Both of the pressure sensors should now be displaying the current ambient pressure and they should be the same value within 3 torr of each other.

5. Back - **Pressure Calibration Menu** - (read note) - OK.

---

### 5.3 Pressure Calibration (Internal Pump Option Only)

---

The internal pump requires a separate pressure calibration procedure that replaces the one used in Section 5.2.

**Note:** Ensure that the instrument has been running for at least one hour before any calibration is performed to ensure sufficient stability.

**Note:** Ensure units of measure are the same on both the barometer and instrument.

#### Equipment Required

- Barometer

#### Procedure

1. Disconnect any external tubing connected to the rear ports of the instrument.
2. Open - **Main Menu** → **Calibration Menu** → **Pressure Calibration** - (read displayed note) - OK.

**Note:** This action will place the valve sequence on hold; normal sampling will be interrupted.

3. Edit - **Vacuum Set Pt.** - (Read displayed instructions) - OK.
4. Connect a barometer to the **Sample Port** (refer to Figure 5).
5. Wait 2-5 minutes and ensure the pressure reading on the barometer has dropped and is stable.
6. Enter the barometer reading into the instrument - Accept.
7. Read displayed instructions - OK.
8. The pump should now stop automatically. Disconnect the barometer from the **Sample Port**.
9. Wait 2-5 minutes and enter the ambient barometer reading into the instrument - Accept.

**Note:** Both of the pressure sensors should now be displaying the current ambient pressure and they should be the same value within 3 torr of each other.

10. Back - **Pressure Calibration Menu** - (read note) - OK.

---

### 5.4 Zero Calibration

---

Zero precision checks and calibrations are used to determine the zero response of the instrument and set the offset of the instrument if required.

Performing a zero calibration will adjust the **Zero Offset NO2**. This offsets can be checked in the **Main Menu → Service Menu → Calculation Factors Menu** and should be very close to zero. A large offset may indicate a problem with the instrument or calibration system (refer to Section 7).

**Note:** Ecotech encourages regular zero checks; however Ecotech recommends that the zero calibration only be performed when specifically required as it may mask issues that should be addressed during maintenance/service.

A zero calibration can be performed either through the **Calibration Port, Sample Port** or **Internal zero**. Refer to the instructions outlined in the next three sections:

**Note:** Ensure the instrument has been running for at least one hour before any calibration is performed to ensure sufficient stability.

#### 5.4.1 Calibration Port

##### Equipment Required

- Zero source

##### Procedure

1. Ensure a suitable zero source is connected to the **Calibration port**.
2. Open - **Main Menu → Calibration Menu**.
3. Select - **Cal. Type → Manual** - Accept.
4. Select - **Zero Source → External** - Accept.
5. Select - **Cal. Mode → Zero** - Accept.
6. Allow the instrument time to achieve a stable response.
7. Enter - **Zero Calibrate NO2** - OK.
8. Select - **Cal. Mode → Measure** - Accept (To return to sample measure).

#### 5.4.2 Sample Port

##### Equipment Required

- Zero source

##### Procedure

1. Ensure a suitable zero source is connected to the **Sample Port**.
2. Open - **Main Menu → Calibration Menu**.
3. Select - **Cal. Type → Manual** - Accept.
4. Select - **Zero Source → External** - Accept.
5. Select - **Cal. Mode → Measure** - Accept.

6. Allow the instrument time to achieve a stable response.
7. Enter - **Zero Calibrate NO2** - OK.
8. Disconnect the zero source and reconnect the sample line to the **Sample Port**.

### 5.4.3 Internal Zero (Sample Port)

#### Equipment Required

- N/A

#### Procedure

1. Open - **Main Menu** → **Calibration Menu**.
2. Select - **Cal. Type** → **Manual** - Accept.
3. Select - **Zero Source** → **Internal** - Accept.
4. Select - **Cal. Mode** → **Zero** - Accept.
5. Allow the instrument time to achieve a stable response.
6. Enter - **Zero Calibrate NO2** - OK.
7. Select - **Cal. Mode** → **Measure** - Accept (To return to sample measure).

---

## 5.5 Span Calibration

---

A span calibration is a calibration performed at the upper end of the instrument's measurement range. Ecotech recommends calibration at 80 % of the full scale measurement or operating range of the instrument.

While the instrument range is commonly set as a default 0-500ppb, this is widely recognised as no longer being valid with modern digital communication and most regulators will now recommend a range more suited to local conditions.

**Note:** Ensure that the instrument has been running for at least one hour before any calibration is performed to ensure the instrument's stability.

A span gas can be supplied through either the **Calibration Port** or **Sample Port**. Follow the relevant instructions below:

### 5.5.1 Calibration Port

#### Equipment Required

- Span source

#### Procedure

1. Ensure a suitable span source is connected to the **Calibration Port**.

2. If diluting the gas with a dilution calibrator, set the output concentration to 80 % of the instrument measurement range.
3. Open - **Main Menu** → **Calibration Menu**.
4. Select - **Cal. Type** → **Manual** - Accept.
5. Select - **Cal. Mode** → **Span** - Accept.
6. Let the instrument stabilise, typically 15 minutes.
7. Enter - **Span Calibrate NO2** - (Enter the span output concentration) - Accept.
8. Select - **Cal. Mode** → **Measure** - Accept (To return to sample measure).

### 5.5.2 Sample Port

#### Equipment Required

- Span source

#### Procedure

1. Ensure a suitable span source is connected to the **Sample Port**.
2. If diluting the gas with a dilution calibrator, set the output concentration to 80 % of the instrument measurement range.
3. Open - **Main Menu** → **Calibration Menu**.
4. Select - **Cal. Type** → **Manual** - Accept.
5. Select - **Cal. Mode** → **Measure** - Accept.
6. Let the instrument stabilise, typically 15 minutes.
7. Enter - **Span Calibrate NO2** - (Enter the span output concentration) - Accept.
8. Disconnect the span source and reconnect the sample line to the **Sample Port**.

### 5.5.3 Manual Instrument Gain and Offset Adjustments



#### CAUTION

Manual adjustment of the Instrument Gain does not take into account the PTF correction and can lead to an incorrect calibration

At times it may be desirable to manually adjust the instrument's gain and offsets. Typically this option is only used when an instrument calibration has been corrupted and the user wishes to reset the instrument response factors prior to performing a new calibration.

To manually adjust the instrument follow the below procedure:

1. Open - **Main Menu** → **Service Menu** → **Calculation Factors Menu**.
2. Edit - **Instrument Gain** - (Adjust as required. 1 is the default).
3. Edit - **Zero Offset NO2** - (Adjust as required. 0 is the default).

---

## 5.6 Precision Check

---

Similar to a normal zero or span calibration, a precision check is a Level 2 calibration that may be performed using a non-certified reference. The instrument is supplied with a known concentration of span gas (or zero air) and the instrument's response observed. However, no adjustment to the instrument response is made during a precision check.

**Note:** Ensure that the instrument has been running for at least one hour before any calibration is performed to ensure the instrument's stability.

A precision check can be performed either manually via the **Sample Port** or **Calibration Port** or can also be performed automatically using the Timed Mode (refer to Section 3.4.10.2).

### Procedure

1. Supply the instrument with a zero source (refer to Section 5.4 for the procedure of setting up a zero, but do not do a **Zero Calibrate NO2**).
2. Observe and record the measurement from the instrument.
3. Supply the instrument with a span source (refer to Section 5.5 for the procedure of setting up a span but do not do a **Span Calibrate NO2**).
4. Observe and record the measurement from the instrument.
5. Check both readings against your local applicable standards.

If an instrument fails a span precision check (based on the users local applicable standards), perform a span calibration (refer to Section 5.5).

If an instrument fails a zero precision check (based on the users local applicable standards), resolve the issue by referring to Section 7.

---

## 5.7 Multipoint Precision Check

---

A multipoint precision check is used to determine the linear response of the instrument across its operating range. The instrument is supplied with span gas at multiple known concentrations, typically a zero point and at least four up-scale points, spread across the operating range of the instrument. The observed concentrations are compared to expected values and the linearity of the instrument assessed against local applicable standards.

**Note:** The instrument is inherently linear and the instrument gain should **not** be adjusted at each individual point. Non-linearity indicates a problem with the instrument or calibration system (refer to Section 7). Ensure that the instrument has been running for at least one hour before any calibration is performed to ensure the instrument's stability.

Several methods for producing multiple known concentrations are available to use, such as connecting multiple certified gas cylinders at different concentrations. However, Ecotech strongly

recommends the use of a dilution calibrator and a certified cylinder of NO<sub>2</sub> at an appropriate concentration (typically a cylinder of 40 to 100 ppm, balance in Nitrogen).

### Equipment Required

- Gas Dilution Calibrator (such as a Serinus Cal 1000).
- A NO<sub>2</sub> gas cylinder reference standard
- Zero Air Generator

### Procedure

1. Connect your calibration system to the **Calibration Port** of the instrument (Ecotech recommends the Serinus Cal 1000, refer to Figure 43).
2. Generate and record the displayed span concentrations for (at least) five stepped points (of known concentrations) evenly spaced across the instruments measurement range (see the example below).
3. Then using a program such as MS Excel, create an X Y scatter plot of expected concentration versus the recorded instrument response and use linear regression to calculate the line of best fit and the correlation factor (R<sup>2</sup>) – refer to the users local applicable standards.

Example for an instrument measurement range of 500 ppb:

- a. For the 1st concentration, set the gas dilution calibrator to supply **400 ppb** NO<sub>2</sub> gas to the instrument.
- b. Allow the instrument to sample the calibration gas until a prolonged stable response is achieved (the amount of time this takes is impacted by the calibration setup). Record the instrument response.
- c. Repeat the above steps using concentrations of **300ppb, 200ppb, 100ppb** and a **Zero** point.
- d. Graph the results and use linear regression to determine a pass or fail as per your applicable local standards.

$$y = mx + c$$

**Note:** To highlight hysteresis errors, it is advisable to run the multipoint check in both *descending* and *ascending* order - refer to applicable local standards.



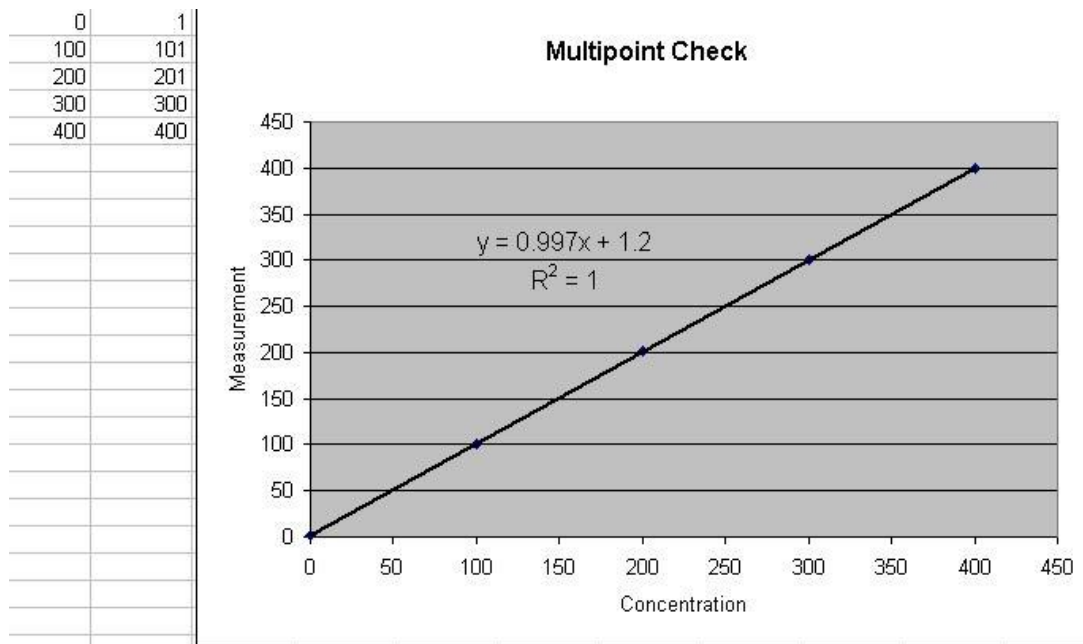

**Figure 45 – Multipoint Calibration Results Example**

4. The following is a guide to approximate expected good results for 0-400 ppb.
  - a. The gradient (m) falls between 0.98 and 1.02.
  - b. The intercept (b) lies between -2 and +2.
  - c. The correlation ( $R^2$ ) is greater than 0.99.

If unsatisfactory results are observed, please refer to Section 7 - troubleshooting.

## 5.8 High Pressure Zero/Span Valve

If the instrument was ordered with this option, the internal pressurised calibration valves will already be installed within the instrument as either a zero or span calibration source, thus no other internal connections need to be made.

**Note:** Before using a high pressure span or zero as a source for calibrating the instrument, please check the local regulatory requirements. This is generally only be used as an operational check of the instrument's zero point and single span point (recommended as 80 % of full scale).

### 5.8.1 Single Pressurised Calibration Option

#### Set-Up of Single Calibration Option

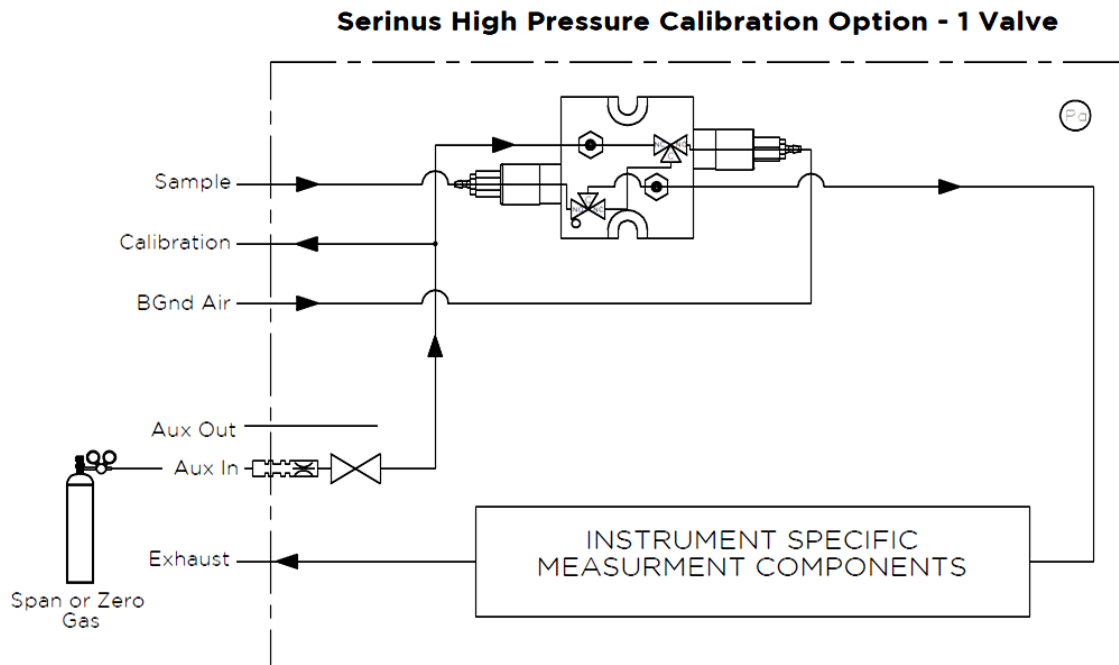

**Figure 46 – Single High Pressure Calibration Option**

When using the pressurised calibration option, either a high pressure zero or span cylinder (depending on the option you have ordered) should be connected to the **Aux In Port**.

#### Equipment Required

- Calibrated Flow Meter
- Gas Cylinder

#### Procedure

1. Ensure the gas cylinder is fitted with an appropriate gas regulator with a shut off valve.
2. Connect a ¼" line of stainless steel tubing between the gas cylinder and the **Aux In Port**.

**Note:** This connection may need to be retightened during this operation.

3. Open the cylinder main valve and adjust the regulator to 15 psig.
4. Open the regulator's shutoff valve and test for leaks:
  - a. Pressurise the line.
  - b. Close the cylinder main valve.
  - c. If pressure drops by more than 2 PSI over five minutes, check the connections and retest.
  - d. Open cylinder main valve.

5. Temporarily place a flow meter on the **Calibration Port** (this port is now used as the high pressure calibration vent).
6. Open - **Main Menu** → **Calibration Menu**.
7. Select - **Cal. Type** → **Manual** - Accept.
8. Select - **Cal. Mode** → **Span** or **Zero** - Accept (depending on the option installed).

**Note:** When using the high pressure zero option, ensure **Zero Source** is set to **External**.

9. Adjust the regulator pressure until the flow meter on the vent line (**Calibration Port**) is between 0.5 and 1 slpm. This flow rate is you excess calibration gas.

**Note:** Do not exceed a pressure of 2 bar, this can damage the instrument and cause gas leakage.

### **Return to Normal Operation**

10. Select - **Cal. Mode** → **Measure** - Accept. (To return to sample measure).
11. Remove the flow meter on the **Calibration Port** and connect a vent line.
12. Reconnect the instrument fittings and return to the original set-up.

The instrument is now in normal operation mode. When either zero or span calibration is initiated (depending on which option has been installed) the instrument will automatically open the valves to run a pressurised calibration.

## 5.8.2 Dual Pressurised Calibration Option

### Set-Up of Dual Calibration Option

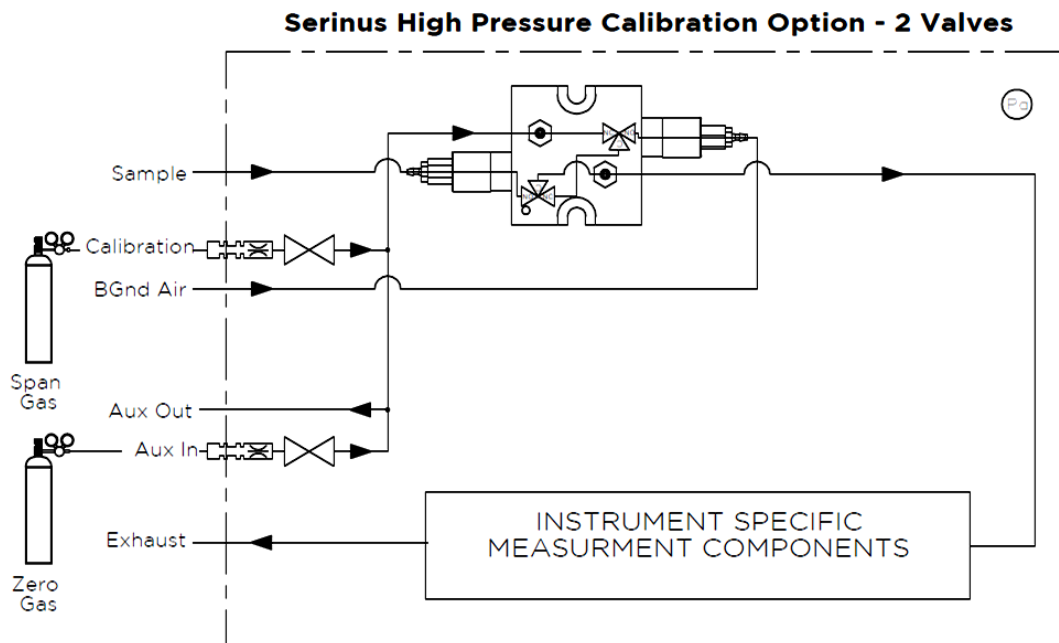

**Figure 47 – Dual High Pressure Calibration Option**

When using the dual pressurised calibration option, a high pressure zero cylinder should be connected to the **Aux In Port** and a high pressure span cylinder connected to the **Calibration Port**.

### Equipment Required

- Calibrated Flow Meter
- Gas Cylinder of Zero air
- Gas Cylinder of NO<sub>2</sub>

### Procedure

1. Ensure the gas cylinder is fitted with an appropriate gas regulator with a shut off valve.
2. Connect a ¼" line of stainless steel tubing between the appropriate gas cylinders and the instrument's **Aux In Port** and **Calibration Port**.

**Note:** This connection may need to be retightened during this operation.

3. Open the cylinder main valve and adjust the regulator to 15 psig.
4. Open the regulator's shutoff valve and test for leaks:
  - a. Pressurise the line.
  - b. Close the cylinder main valve.

- c. If pressure drops by more than 2 PSI over five minutes, check the connections and retest.
- d. Open cylinder main valve.
5. Temporarily place a flow meter on the **Aux Out Port** (This port is now used as the high pressure calibration vent for both span and zero).
6. Open - **Main Menu** → **Calibration Menu**.
7. Select - **Cal. Type** → **Manual** - Accept.
8. Select - **Cal. Mode** → **Zero** - Accept.

**Note:** When using the high pressure zero option, ensure **Zero Source** is set to **External**.

9. Adjust the regulator pressure until the flow meter on the vent line (**Aux Out Port**) is between 0.5 and 1 slpm. This flow rate is you excess calibration gas.

**Note:** Do not exceed a pressure of two bars, this can damage the instrument and cause gas leakage.

10. Select - **Cal. Mode** → **Span** - Accept.
11. Adjust the regulator pressure until the flow meter on the vent line (**Aux Out Port**) is between 0.5 and 1 slpm. This flow rate is you excess calibration gas.

**Note:** Do not exceed a pressure of two bars, this can damage the instrument and cause gas leakage.

### **Return to Normal Operation**

12. Select - **Cal. Mode** → **Measure** - Accept. (To return to sample measure).
13. Remove the flow meter on the **Aux Out Port** and connect a vent line.
14. Reconnect the instrument fittings and return to the original set-up.

The instrument is now in normal operation mode. When either zero or span calibration is initiated the instrument will automatically open the valves to run a pressurised calibration.

This page is intentionally blank.

## 6. Service

---

### 6.1 Maintenance Tools

---

To perform general maintenance on the Serinus 60 the user may require the following equipment:

- Customizable Test Equipment Case PN: H070301
- Digital Multimeter & Leads (DMM) PN: E031081 & E031082
- Barometer PN: E031080
- Thermometer & Probe PN: E031078 & E031079
- Flow Meter (Select Range)
  - Range: 50 sccm to 5000 sccm PN: ZBI-200-220M
  - Range: 300 sccm to 30000 sccm PN: ZBI-200-220H
- Minifit Extraction Tool PN: T030001
- Orifice/Sintered Filter Extraction Tool PN: H010046
- Leak Test Jig PN: H050069
- Computer/Laptop and Connection Cable for Diagnostic Tests
- Assortment of 1/4" and 1/8" Tubing and Fittings
- Hand Tools
- Zero Air Source
- Span Gas Source



**Figure 48 – Minifit Extraction Tool – (T030001)**

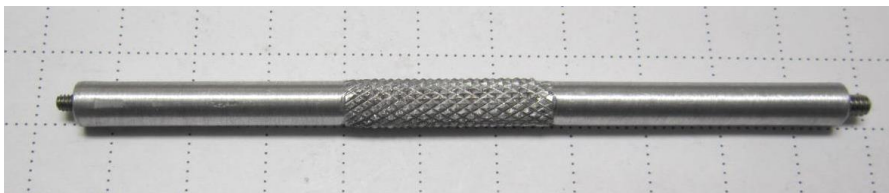

**Figure 49 – Orifice/Sintered Filter Removal Tool – (H010046)**

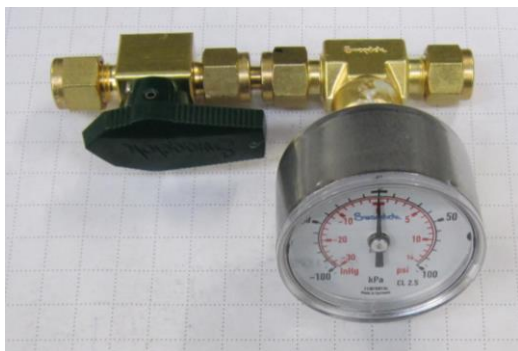

**Figure 50 – Leak Test Jig – (H050069)**



**Figure 51 – Air Monitoring Test Equipment Kit (AMTEK) – Customisable**

## 6.2 Maintenance Schedule

The maintenance intervals are determined by compliance standards that differ in various regions. The following is recommended by Ecotech as a guide. Compliance with local regulatory or international standards is the responsibility of the user.

**Table 6 – Maintenance Schedule**

Interval *	Task Performed	Section
Nightly or Every 5 days	Perform precision check (Automated)  Perform precision check (Manual) (This task is performed to ensure a high data capture rate)	5.6



Monthly	Perform precision check (pre-check) prior to commencing any service tasks or making any changes to the system as found in its current state. This task is necessary to validate any previously captured data.	5.6
	Check particulate filter, replace if full/dirty	6.3.2
	Perform a pressure check	6.3.8
	Check sample inlet system for moisture or foreign materials. Clean if necessary	
	Check fan filter and clean if necessary	6.3.3
	Check event log	3.4.1
	Check date and time is correct	3.4.8
	Check instrument status light	3.3.1
	External vacuum pump check (vacuum source) Or Internal pump check	
	Leak check	6.3.6
	Perform a manual background, record background reading ensure it is less than 600 Mm-1. Observe the trend and if the reading will increase to > 650 Mm-1 within the next 6 months perform a background scrubber DAU check.	6.3.1
	Perform NO <sub>2</sub> span calibration	5.5
	Perform precision check (post-check) once all service tasks have been completed. This task is necessary to establish a valid start point to begin capturing new data.	5.6
3 Monthly	Replace sample DFU (depending on site conditions) *	6.3.4
6 Monthly	Perform multipoint precision check	5.7
	Calibrate analog outputs (only if used)	3.4.25
Yearly	Replace Background Scrubber DAU (depending on site conditions) *	6.3.5
	Flow check, replace or clean orifice (only if necessary)	

\* Suggested intervals for maintenance procedure are a guide only and may vary with sampling intensity and/or environmental conditions. Please refer to your local regulatory standard for your personalised maintenance schedule.

## 6.3 Maintenance Procedures

---

### 6.3.1 Background Scrubber DAU check

The internal background scrubber Disposable Absorbent Unit (DAU) removes pollutants from the sample stream providing a source of continuous NO<sub>2</sub> free air for background and internal zero functions. Failure of the absorbent can result in drift, poor sensitivity near zero and high background readings.

**Note:** Ensure that the instrument has been running for at least one hour before this procedure is performed.

#### Equipment Required

- Span gas source 400ppb NO<sub>2</sub>
- 5/8" Spanner

#### Procedure

1. Open - **Main Menu** → **Calibration Menu**.
2. Select - **Cal. Type** → **Manual** - Accept.
3. Select - **Zero Source** → **Internal** - Accept.
4. Select - **Cal. Mode** → **Zero** - Accept.
5. Allow the instrument to sample Zero air for approximately five minutes.
6. Record the instrument response as the "Initial" value.

**Note:** This value should be  $0.00 \pm 1$  ppb. If it is not, a background should be initiated by selecting **Manual Background** from within the **Calibration menu**. The background will take approximately five minutes to complete (refer to Section 3.4.10).

7. Connect 400 ppb NO<sub>2</sub> span source to the Sample Port ensuring the inlet pressure is maintained at ambient (vented).
8. Allow the instrument to sample the span source for five minutes.
9. Record the instrument response as the "Challenge" value.
10. Disconnect the span source.
11. Open - **Main Menu** → **Calibration Menu**.
12. Select - **Cal. Mode** → **Measure** - Accept.
13. Select - **Zero Source** → **External** - Accept.
14. Compare the "Initial" value and the "Challenge" value. They should agree within  $\pm 2$  ppb otherwise replace the background scrubber DAU.

### 6.3.2 Particulate Filter Replacement

Contamination of the filter can result in degraded performance of the instrument, including slow response time, erroneous readings, temperature drift and various other problems.

1. Turn off the external pump (if an internal pump is installed refer to Section 8.2.3) and allow the instrument to return to ambient.
2. Slide open the lid of the instrument to access the particulate filter (located in front right hand corner).
3. Unscrew the filter cap (bright blue) by turning it counter-clockwise.
4. Remove the filter plunger from the casing, place finger on tubing connector and pull to the side (refer to Figure 52).

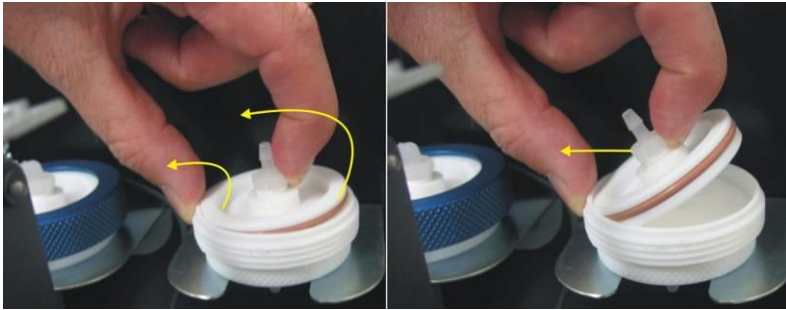

**Figure 52 – Removing the Plunger**

5. Remove the old filter paper, wipe down the plunger with a damp cloth and insert a new filter.
6. Replace the plunger, screw on the filter cap.
7. Close the instrument and perform a leak check (refer to Section 6.3.6).

### 6.3.3 Clean Fan Filter

The fan filter is located on the rear of the instrument. If this filter becomes contaminated with dust and dirt it may affect the cooling capacity of the instrument.

1. Remove outer filter casing and filter (refer to Figure 53).
2. Clean filter with water and wring dry or shake vigorously.
3. Reinstall filter and filter casing.



Figure 53 – Removing the Fan Filter

### 6.3.4 Sample DFU Replacement

#### Equipment Required

- 5/8" Spanner

#### Procedure

1. Turn off the external pump (if an internal pump is installed refer to Section 8.2.3) and allow the instrument to return to ambient.
2. Loosen the Kynar nuts from both ends of the sample DFU.
3. Remove and replace the sample DFU (refer to Figure 54) and tighten the Kynar nuts finger tight.



Figure 54 – Sample DFU

### 6.3.5 Background Scrubber DAU Replacement

#### Equipment Required

- 5/8" Spanner

## Procedure

1. Turn off the external pump (if an internal pump is installed refer to Section 8.2.3) and allow the instrument to return to ambient.
2. Loosen the Kynar nuts from both ends of the background DAU.
3. Remove and replace the background DAU (refer to Figure 54) and tighten the Kynar nuts finger tight.



Figure 55 – Background DAU

### 6.3.6 Leak Check

#### Equipment Required

- Source of Vacuum (pump)
- Leak Test Jig (PN: H050069)
- Kynar ¼" Blocker Nuts
- Tubing and Assorted Fittings
- 5/8" Spanner
- 9/16" Spanner

#### Procedure

**Note:** Ensure that the instrument has been running for at least one hour before this procedure is performed.

1. Disconnect all external tubing connected to the rear ports of the instrument.
2. Connect a leak check jig to the Exhaust Port of the instrument.
3. Connect a vacuum source to the shut off valve end of the leak test jig ensuring the shut off valve is in the open position.
4. Open - **Main Menu** → **Service Menu** → **Diagnostics Menu** → **Valve Menu**.
5. Disable - **Valve Sequencing** → **Disabled**.
6. Turn **Off** all the valves

7. Block the **Sample Port** with a Kynar ¼" Blocker Nut.
8. Allow the instrument time to evacuate the pneumatic system (the time required will depend on the vacuum source used).
9. Close the shut off valve and record the vacuum. Wait for three minutes and observe the gauge on the leak check jig. It should not drop more than 5 kpa (37.5 torr). If the leak check passed skip to step 12.
10. Inspect the instrument's plumbing looking for obvious damage. Check the condition of fittings and sample filter holder seating plus condition of the O-ring.
11. If the leak is still present divide up the pneumatic system into discrete sections to locate the leak (refer to Section 7.1). When the location of the leak has been determined repair and then rerun the leak check procedure.
12. Slowly remove the blocker on the **Sample Port** allowing the gauge on the leak test jig to return to ambient. Inspect the internal tubing to ensuring that the tubing is cleanly connected to the fittings and that the internal Teflon lining has not been kinked or crumpled.
13. Remove the leak check jig.
14. Enable - **Valve Sequencing** → **Enabled**.

#### 6.3.6.1 Leak Check (Internal pump option)

##### Equipment Required

- Barometer
- Kynar ¼" Blocker Nuts
- 5/8" Spanner

##### Procedure

**Note:** Ensure that the instrument has been running for at least one hour before this procedure is performed.

1. Disconnect all external tubing connected to the rear ports of the instrument.
2. Open - **Main Menu** → **Service Menu** → **Diagnostics Menu** → **Internal Pump Menu**.
3. Select - **Flow Control** → **Manual** - Accept.
4. Edit - **Coarse** - (set to 255) - Accept.
5. Edit - **Fine** - (set to 255) - Accept.
6. Open - **Main Menu** → **Service Menu** → **Diagnostics Menu** → **Valve Menu**.
7. Disable - **Valve Sequencing** → **Disabled**.
8. Turn **Off** all the valves.
9. Connect a barometer to the **Sample Port**.
10. Allow the internal pump to time to evacuate the pneumatic system (the time required will depend on the condition of the pump 1 to 2 minutes).
11. Open - **Main Menu** → **Service Menu** → **Diagnostics Menu** → **Internal Pump Menu**.

12. Toggle Off - **Internal Pump** → **Off**.
13. Note the value on the barometer. Wait for three minutes, the value should not drop more than 5 kpa (37.5 torr). If the leak check passed skip to step 16.
14. Inspect the instrument's plumbing looking for obvious damage. Check the condition of fittings and sample filter holder seating plus condition of the O-ring.
15. If the leak is still present divide up the pneumatic system into discrete sections to locate the leak (refer to Section 7). When the location of the leak has been determined repair and then rerun the leak check procedure.
16. Slowly remove the barometer from the **Sample Port** and allow the instrument to return to ambient. Inspect the internal tubing to ensuring that the tubing is cleanly connected to the fittings and that the internal Teflon lining has not been kinked or crumpled.
17. Open - **Main Menu** → **Service Menu** → **Diagnostics Menu** → **Valve Menu**.
18. Enable - **Valve Sequencing** → **Enabled**.
19. Open - **Main Menu** → **Service Menu** → **Diagnostics Menu** → **Internal Pump Menu**.
20. Select - **Flow Control** → **Start** - Accept.

### 6.3.7 Clean Pneumatics

The calibration valve manifold will require disassembling and cleaning. Ideally the valves and the manifold should be cleaned in a sonic bath with lab detergent and water. Once clean rinse with distilled water and dry before reassembling (refer to Section 9.8 and Section 9.9). Leak test the assembly before adding back into the system. Once the system has been reassembled the instrument should have a full system leak check (refer to Section 6.3.6).

If the tubing shows signs of significant contamination, it should be replaced with new tubing.

### 6.3.8 Pressure Sensor Check

Pressure checks are needed to ensure that the pressure sensor is accurately measuring pressure inside the instrument.

During normal operation ensure that the **Pressure & Flow Menu** indicate the following parameters. Ambient should display the current ambient pressure at site. Cell should indicate current measurement cell pressure depending on the pump condition and location. A Cell pressure of between 10 torr and 50 torr is recommended.

#### Equipment Required

- Barometer
- Digital Multimeter (DMM)

#### Procedure

1. Open - **Main Menu** → **Analyser State Menu** → **Pressure & Flow Menu**.

2. Turn off the vacuum pump (if an internal pump is installed refer to Section 8.2.3) and allow the instrument to return to ambient.
3. Disconnect all external tubing connected to the rear ports of the instrument.
4. After two-five minutes observe the pressure readings: ambient, cell and manifold. Ensure that they are reading the same  $\pm 3$  torr ( $\pm 0.4$  kPa).
5. If the readings are outside this level, perform a pressure calibration (refer to Section 5.2).

If the calibration fails, the instrument may have a hardware fault. The cell pressure PCA and the manifold pressure PCA have test points. To determine if the pressure sensor is faulty simply measure the voltage on the test points shown in the photos. The voltage measured across the test point is proportional to the pressure measured by the sensor, so if the sensor is exposed to ambient pressure at sea level then the voltage will be around 4 volts but if the sensor is under vacuum the voltage will be low (for example, 0.5 volts). If the test point measures zero or negative voltage the assembly is most likely faulty and will need to be replaced.

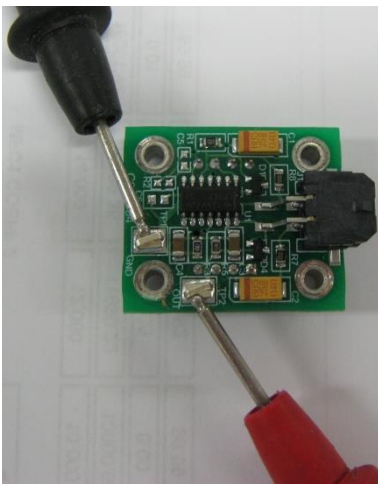

**Figure 56 – Test Point Location**



**Figure 57 – Typical Test Point Reading of Internal Pump Pressure Sensor**





**Figure 58 – Typical Test Point Reading of Measurement Cell Pressure Sensor**

---

## 6.4 Bootloader

---

The Serinus Bootloader is the initial set of operations that the instruments' microprocessor performs when first powered up (similar to the BIOS found in a personal computer). This occurs every time the instrument is powered up or during instrument resets. Once the instrument boots up, it will automatically load the instruments' firmware. A service technician may need to enter the Bootloader to perform advanced microprocessor functions as described below.

To enter the Bootloader turn off the power to the instrument. Press and hold the plus key while turning the power on. Hold the Plus key until the following screen appears.

```
** Ecotech Serinus Analyser **  
V3.1 Bootloader  
Press '1' to enter Bootloader
```

If the instrument displays the normal start up screen, the power will need to be toggled and another attempt will need to be made to enter the Bootloader. Once successful, press 1 to enter the **Bootloader Menu**.

### 6.4.1 Display Help Screen

Once in the Bootloader screen it is possible to redisplay the help screen by pressing 1 on the keypad.

### 6.4.2 Communications Port Test

This test is very useful for fault finding communication issues. It allows a communication test to be carried out independent to any user settings or firmware revisions.

This command forces the following communication ports to output a string of characters: Serial Port RS232 #1, USB rear and Ethernet Port. The default baud rate is 38400 for the RS232 Serial Port. To initiate the test press the number 2 key from the Bootloader screen.

### 6.4.3 Updating Firmware

It is important for optimal performance of the instrument that the latest firmware is loaded. The latest firmware can be obtained by visiting Ecotech's website:

**<http://www.ecotech.com/downloads/firmware>**

Or by emailing Ecotech at [service@ecotech.com](mailto:service@ecotech.com) or [support@ecotech.com](mailto:support@ecotech.com)

To update the firmware from a USB memory stick, use the following procedure:

#### USB Memory Stick Update

1. Turn the instrument off.
2. Place the USB memory stick with the new firmware (ensure that firmware is placed in a folder called FIRMWARE) in the front panel USB Port.
3. Enter the Bootloader (refer to Section 6.4).
4. Select option 3 (upgrade from USB memory stick), press 3 on the keypad.
5. Wait until the upgrade has completed.
6. Press 9 on the keypad to start the instrument with new firmware.

### 6.4.4 Erase All Settings

This command is only required if the instrument's firmware has become unstable due to corrupted settings. To execute this command enter the **Bootloader Menu** (refer to Section 6.4) and press 4 on the keypad.

### 6.4.5 Start Analyser

The start analyser command will simply initiate a firmware load by pressing 9 on the keypad from the **Bootloader Menu**. It is generally used after a firmware upgrade.

## 7. Troubleshooting

**Table 7 – Troubleshoot List**

Error Message/Problem	Cause	Solution
Leak in the instrument	Multiple possibilities	Refer to Section 6.3.6
Flow fault	Multiple possibilities	Refer to Section 7.2
Flow Block Temp. (Flow block temperature failure)	Faulty heater or temperature sensor	Refer to Section 7.4
Cell Temp. (Measurement cell temperature failure)	Faulty heater or temperature sensor	Refer to Section 7.5
Noisy/unstable readings	Multiple possibilities	Refer to Section 7.3
	Calibration system error	<ul style="list-style-type: none"> <li>Ensure calibration system is functioning correctly and is leak free.</li> <li>Ensure sufficient gas is available for the instrument and an adequate vent is available for excess gas.</li> </ul>
	Leaks	<p>A leak in the instrument or calibration system dilutes the sample stream and causes low span readings and noise.</p> <p>Refer to Section 6.3.6</p>
	Measurement cell heater	A failed temperature control allows the instrument to drift with ambient temperature. Verify that the cell temperature is 50 °C ±3 °C.
	Hardware fault	Dust on mirrors or contamination in cell.
	Gain too high	<ul style="list-style-type: none"> <li>Leak check (repair any leaks). Refer to Section 6.3.6.</li> <li>Service instrument.</li> <li>Replace filters.</li> </ul>
Instrument resetting	Multiple possibilities	<ul style="list-style-type: none"> <li>Check that the instrument is not overheating.</li> <li>Possibly a faulty power supply.</li> <li>Corrupted firmware. Perform ‘erase all settings’ in the <b>Bootloader Menu</b> and reload or upgrade firmware.</li> </ul>
12 Voltage supply failure	Power supply has failed	Replace power supply.
No display	AC power	Verify that the mains power cable is connected and the rear fan is operating.

Error Message/Problem	Cause	Solution
	Contrast misadjusted	Adjust the display contrast by pressing two keys on the front panel: <ul style="list-style-type: none"> <li>▪ Press up arrow (▲) for darker contrast</li> <li>▪ Press down arrow (▼) for lighter contrast</li> </ul>
	DC power	Verify that the power supply is providing +12 VDC, -12 VDC and +5 VDC. TP40, TP23 and TP41.
	Display	Check the interface cable between the display and the microprocessor board.
	Bad display or main controller PCA	<ul style="list-style-type: none"> <li>▪ Replace the front panel display.</li> <li>▪ Replace the main controller PCA.</li> <li>▪ Bad cables are unlikely, but if you suspect it perform a pin-for-pin continuity test using an ohmmeter.</li> </ul>
Sample pressure too high or too low	Loss of pressure calibration	Ensure particulate filter has been recently changed. Ensure tubing is not kinked or blocked. Ensure vacuum pump is correctly installed and operating. Perform a pressure calibration (refer to Section 5.2).
Sample flow not at 0.5 slpm	Multiple possibilities	<ul style="list-style-type: none"> <li>▪ Check/replace samples filter</li> <li>▪ Check pump</li> <li>▪ Check valves</li> <li>▪ Re-calibrate pressure sensors</li> </ul>
Unstable flow or pressure readings	Faulty pressure sensors	Check pressure transducer calibration. Check calibration valve block is functioning and not blocked. If unable to diagnose problem, check voltage across TP1 and TP2 of manifold pressure PCA ensure it is about 4 volts $\pm 0.5$ volts. Check voltage across TP1 and TP2 of cell pressure PCA (with vacuum connected) ensure it is about 1 volts $\pm 0.5$ volts. If unable to diagnose problem it may be a noisy A/D converter, replace main controller PCA.
Low span	Leaks	A leak in the instrument or calibration system dilutes the sample stream and causes low span readings and noise. Refer to Section 6.3.6.
	Span calibration out	Adjust the span using the calibration procedure.
No response to span gas	Leaks/blockages	Leaks or blockages in tubes or valves. Perform leak check and flow check and repair any leaks/blockages. Refer to Section 6.3.6.
	Faulty calibration source	Ensure calibration gas is plumbed correctly, is not contaminated, has no leaks and is a certified reference gas.
	Hardware fault	Faulty measurement cell.
Zero drift	Not enough zero air supplied	Check calibrator excess flow is sufficient.

Error Message/Problem	Cause	Solution
	Faulty zero air	Ensure zero air source is not overly polluted.
	Leak	Perform leak test. Refer to Section 6.3.6.

## 7.1 Leak Check

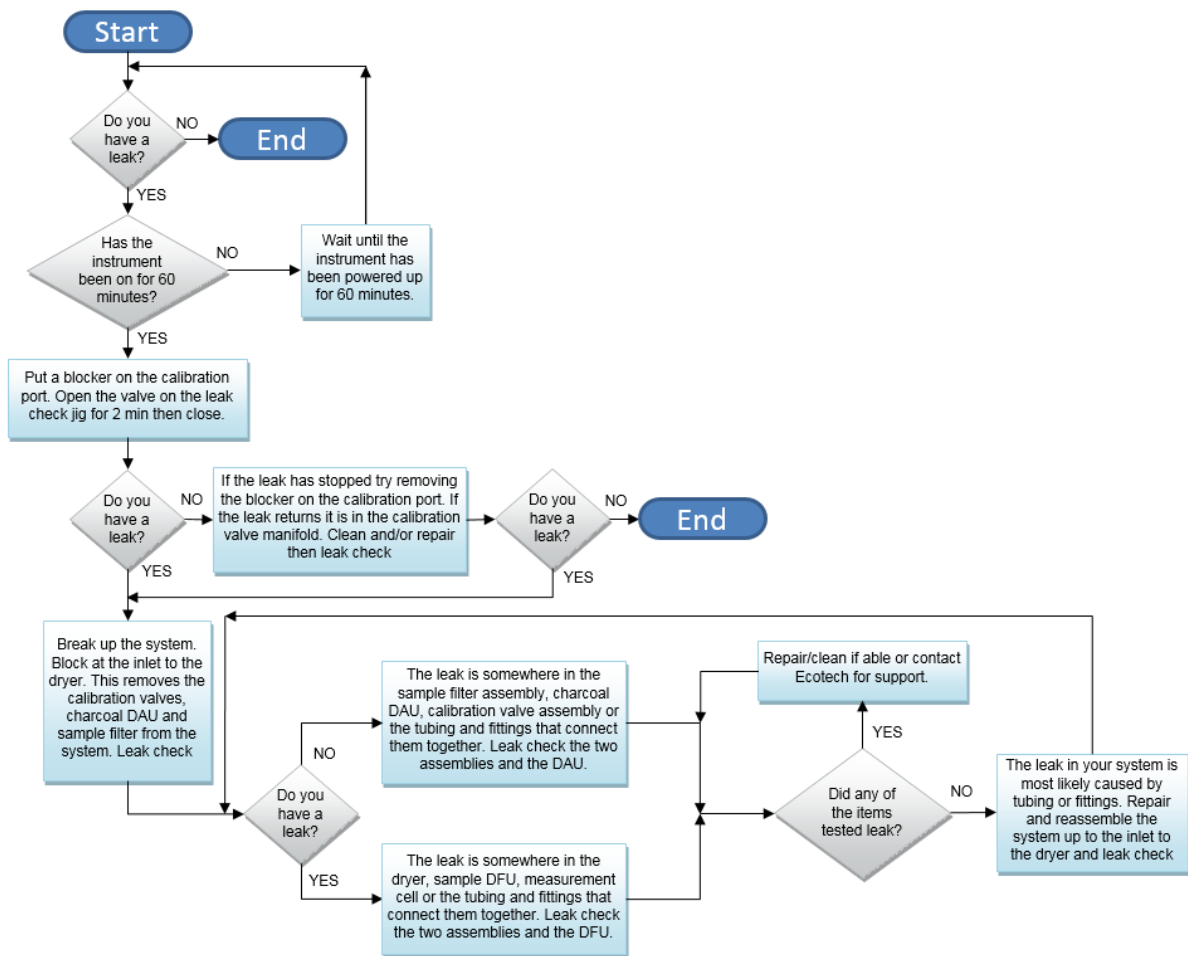

Figure 59 – Leak Check Troubleshooting Flow Chart

## 7.2 Flow Fault

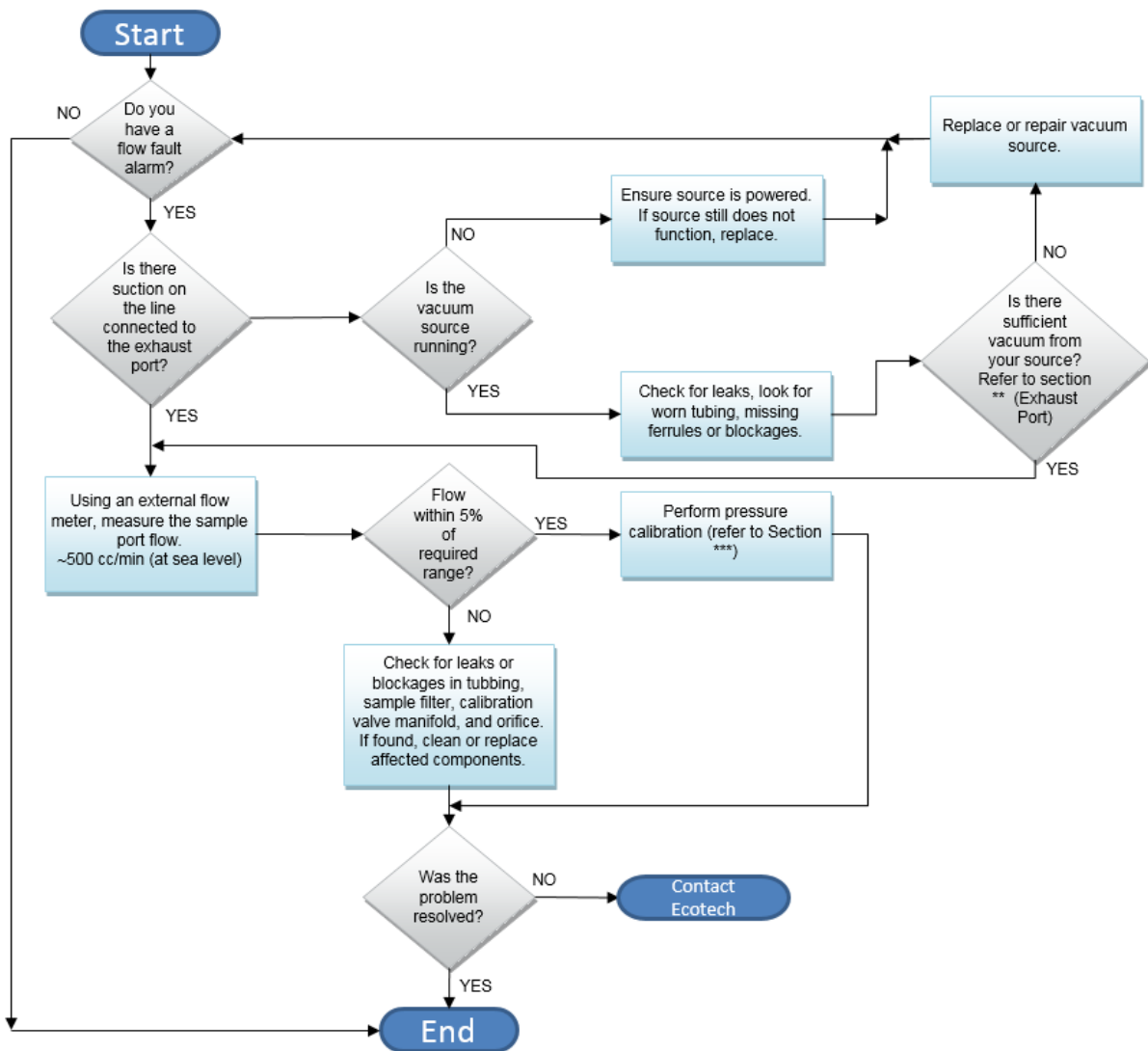
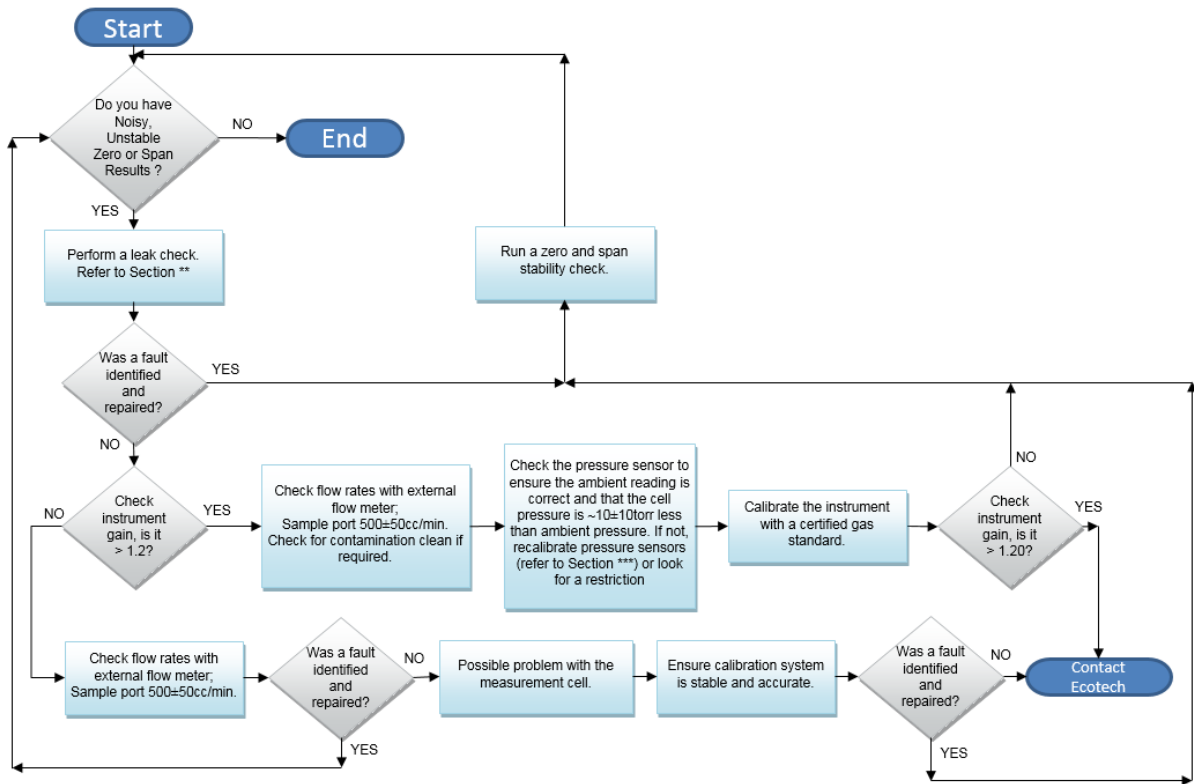

Figure 60 – Zero Flow Fault Troubleshooting Flow Chart

\*\* Section 2.3.1

\*\*\* Section 5.2

## 7.3 Noisy/Unstable Readings



**Figure 61 – Noisy or Unstable Readings Troubleshooting Flow Chart**

\*\* Section 6.3.6

\*\*\* Section 5.2

## 7.4 Flow Block Temperature Failure

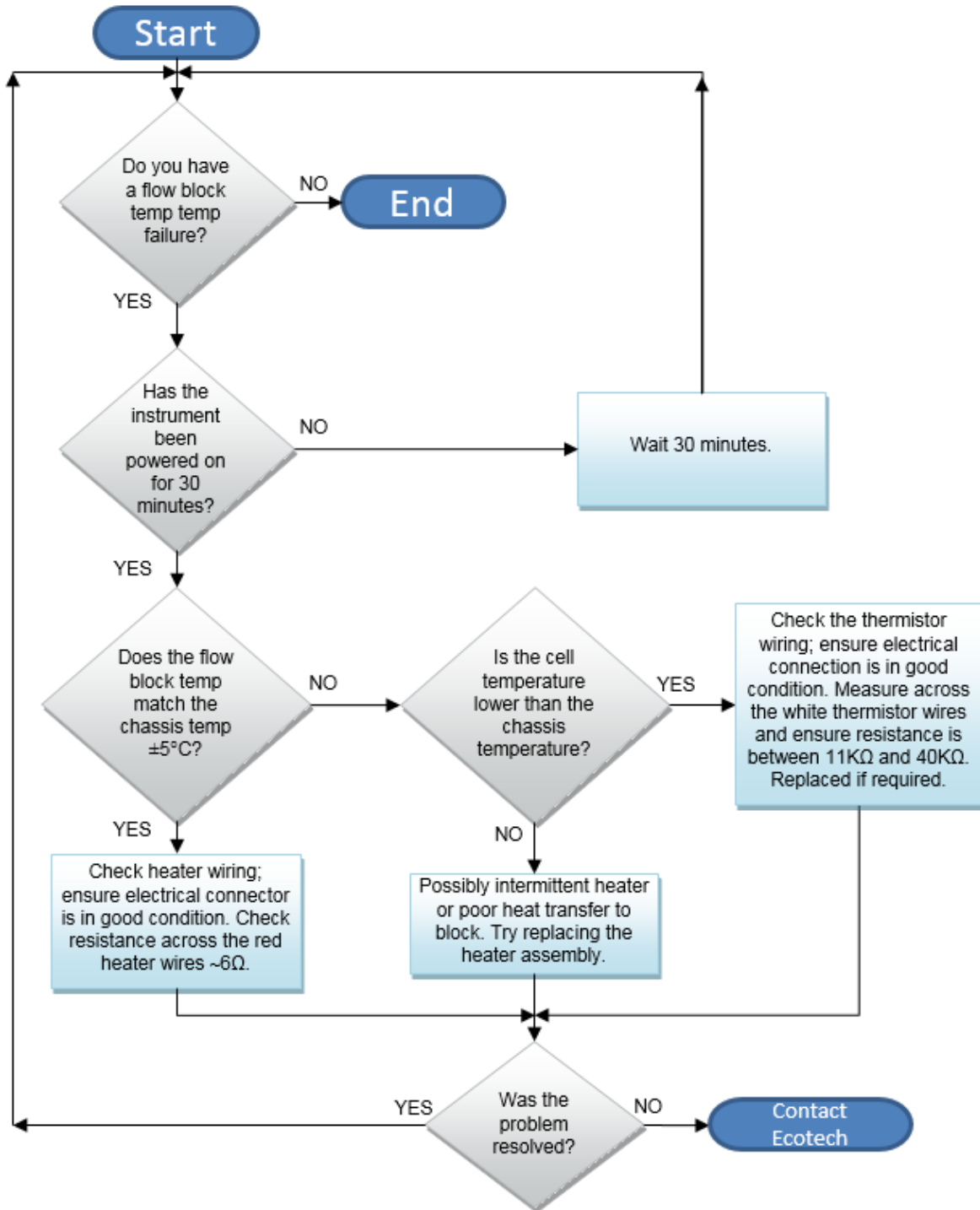

Figure 62 – Flow Block Temp failure Troubleshooting Flow Chart



## 7.5 Measurement Cell Temperature Failure

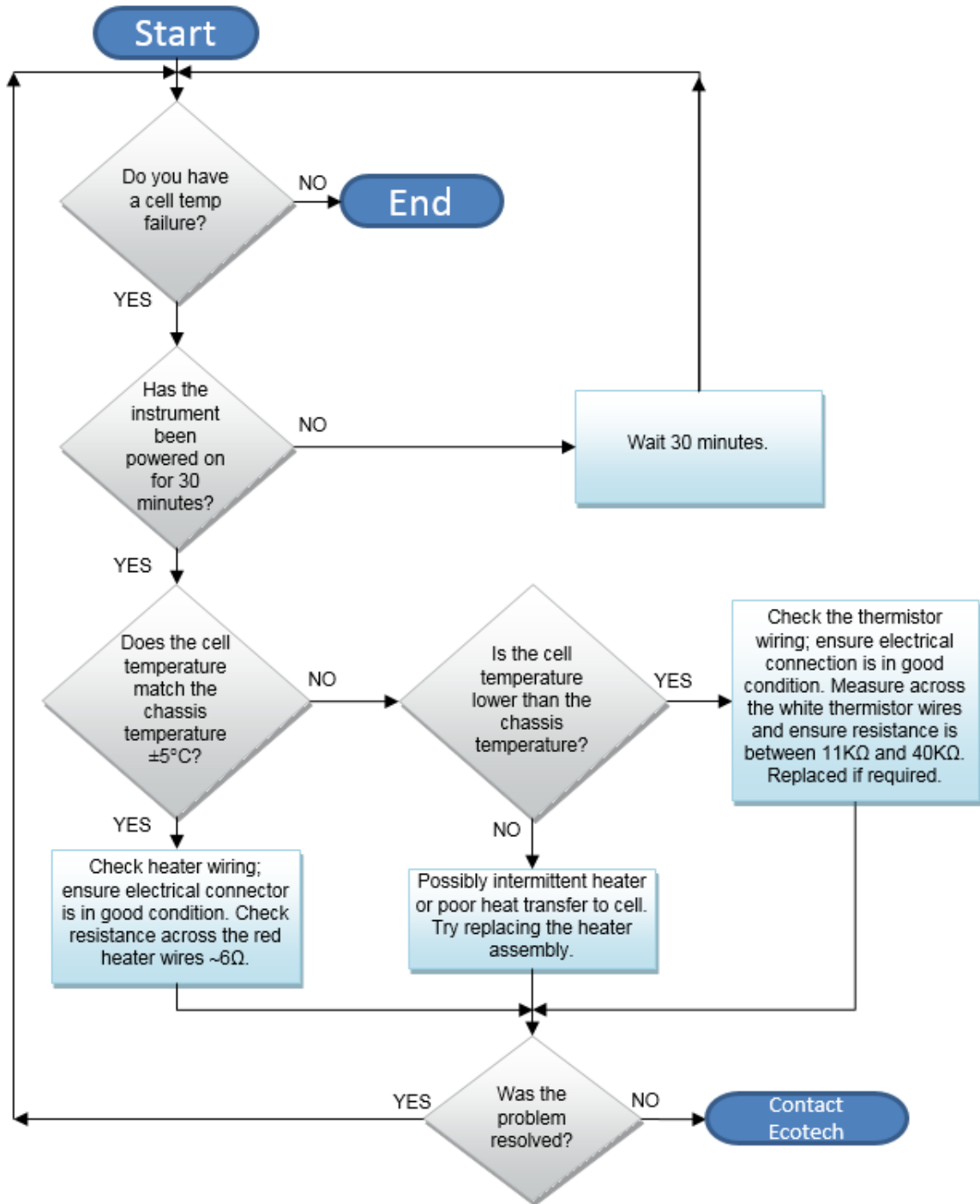

Figure 63 – Measurement Cell Temperature Failure Troubleshooting Flow Chart

## 7.6 USB Memory Stick Failure

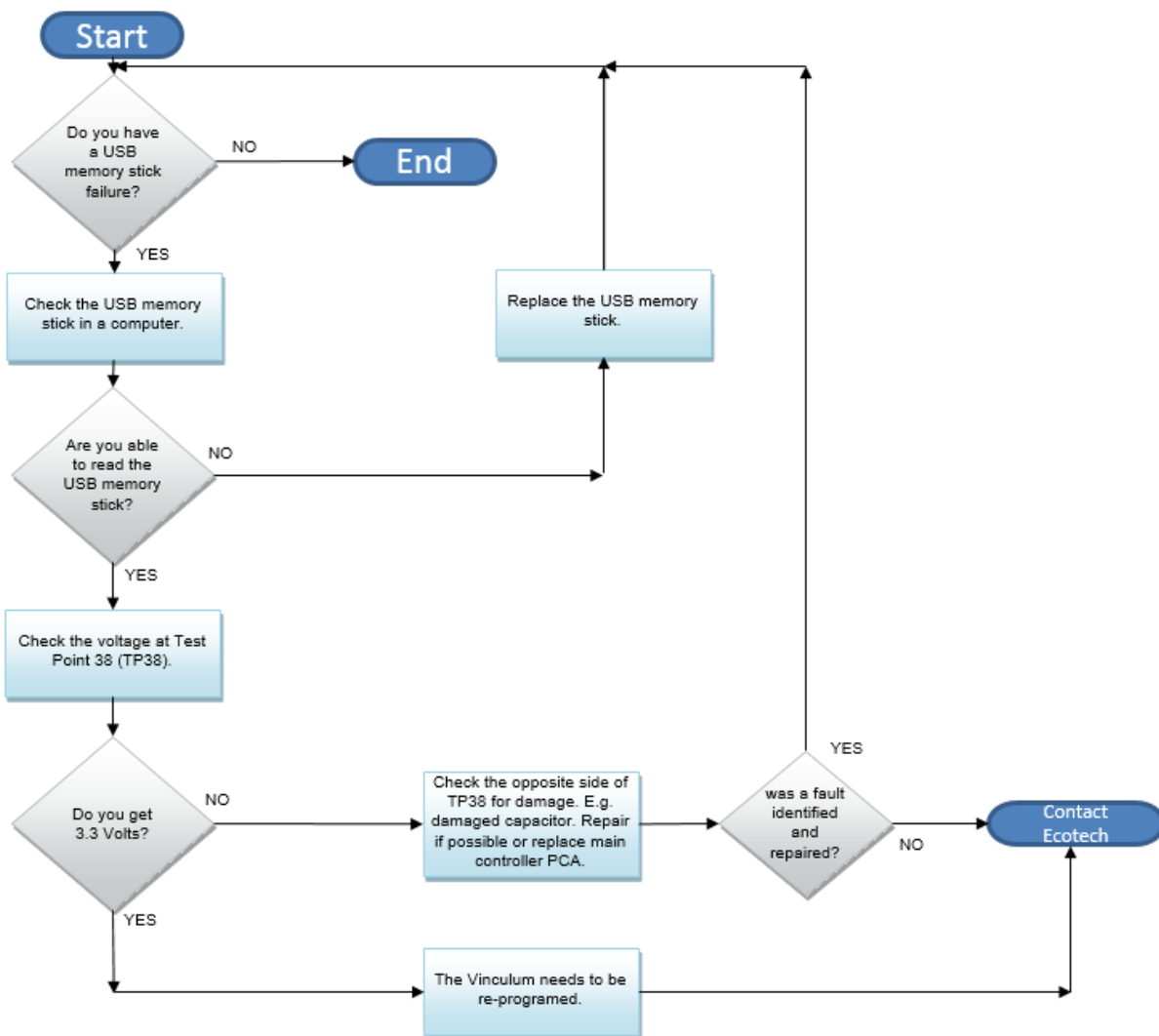

Figure 64 – USB Memory Stick Failure

---

## 7.7 Ecotech Service Support Files

---

Regular backup of the settings, parameters and data on the instruments USB memory stick is recommended.

In the event of a fault that requires Ecotech technical support, please make copies of the following files and email to: [support@ecotech.com](mailto:support@ecotech.com)

### Equipment Required

- PC/Laptop

### Procedure

State the ID number, variant, board revision and firmware version of the instrument with a brief description of the problem. Take a copy of the current configuration if possible and a save of the parameters.

1. Open - **Main Menu** → **Analyser State Menu**.
2. **Variant** - (take note).
3. **Ecotech ID** - (take note).
4. **Board Revision** - (take note).
5. **Firmware Ver.** - (take note).
6. Open - **Main Menu** → **Service Menu**.
7. Save - **Save Configuration** - (CONFIG\*\*.CFG) - Accept.

**Note:** CONFIG99.CFG is the “Factory Backup” file, this is the configuration of the instrument as it left the factory. It is recommended that this file is kept unchanged but can be used as a reference backup point.

\*\* Can be any number from 0 – 98.

8. Save - **Save Parameter List** - (PARAM\*\*.TXT) - Accept.
9. Eject - **Safely Remove USB Stick** - (Follow instructions).

**Note:** PARAM99.TXT is the “Factory Backup” file, This is a snap shot of the parameters while it was under test in the factory just prior to release. It is recommended that this file is kept unchanged but can be viewed for reference.

\*\* Can be any number from 0 – 98.

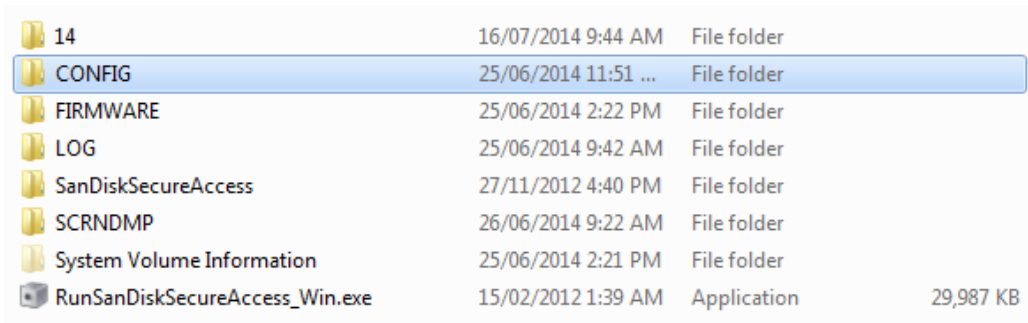

14	16/07/2014 9:44 AM	File folder	
CONFIG	25/06/2014 11:51 ...	File folder	
FIRMWARE	25/06/2014 2:22 PM	File folder	
LOG	25/06/2014 9:42 AM	File folder	
SanDiskSecureAccess	27/11/2012 4:40 PM	File folder	
SCRNDMP	26/06/2014 9:22 AM	File folder	
System Volume Information	25/06/2014 2:21 PM	File folder	
RunSanDiskSecureAccess_Win.exe	15/02/2012 1:39 AM	Application	29,987 KB

**Figure 65 – USB Memory Stick File Structure**

10. Insert the USB memory stick into your PC/Laptop computer and access the files.
11. Best practice is to email all the on the USB memory stick but if it's too large just send:
12. The CONFIG\*\*\*.CFG and PARAM\*\*\*.TXT files that are saved in the CONFIG folder.
13. The LOG files (Event Log text files) and data files (14=Year, Sub folder=month).
14. Safely Eject the USB from the PC/Laptop and return to the instrument.

## 8. Optional Extras

---

### 8.1 Dual Sample Filter (PN: E020100)

---

The dual filter is designed with two sample filters plumbed in parallel with a split line. This formation allows sample flow not to be affected, yet reduces the loading on each filter and therefore the frequency with which they will need to be changed.

The dual filter option is shown in the pneumatic diagram (dashed line) and requires no operational changes to the instrument.

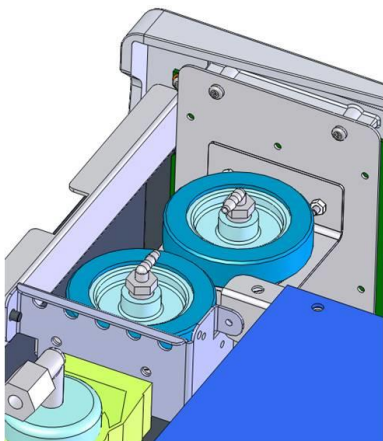

**Figure 66 – Dual Filter Option Installed**

---

### 8.2 Internal Pump (PN: E020124)

---

The Serinus internal pump installed option can be selected when purchasing your analyser.

#### 8.2.1 Hardware Setup

This procedure should be followed after a factory reset.

#### Equipment Required

- NA

#### Procedure

1. Press - (the green instrument status light), this will take you to the home screen.
2. Press - (-99+) on the keypad. This will open the **Advanced Menu**.
3. Open - **Advanced Menu** → **Hardware Menu**.
4. Enable - **Internal Pump** → **Enabled**.

## 8.2.2 Pressure Calibration

Refer to Section 5.3

## 8.2.3 Pump control

This section describes how to turn off and on the internal pump for servicing and maintenance purposes.

### Procedure

1. Open - **Main Menu** → **Service Menu** → **Diagnostics Menu** → **Internal Pump Menu**.
2. Select - **Flow Control** → **Manual**.
3. Toggle Off - **Internal Pump** → **Off**.

## 8.3 Rack Mount Kit (PN: E020116)

The rack mount kit is necessary for installing the Serinus into a 19" rack (the Serinus is 4RU in height).

**Table 8 – Included Parts (Rack Mount Kit)**

Parts Removed	Quantity	Part Numbers
Rack Slide Set	1	H010112
Rack Mount Adaptors	4	H010133
Rack Mount Ears	2	H010134
Spacers	4	HAR-8700
M6 x 20 Button Head Screws	8	
M6 Washers	16	
M6 Nyloc Nuts	8	
M4 x 10 Button Head Screws	18	
M4 Washers	8	
M4 Nyloc Nuts	8	
M6 Cage Nuts	8	

### Installing the Instrument

1. Remove the rubber feet from the instrument (if attached).
2. Separate the slide rail assembly by pressing the black plastic clips in the slide rails to remove the inner section of the rail (refer to Figure 67).

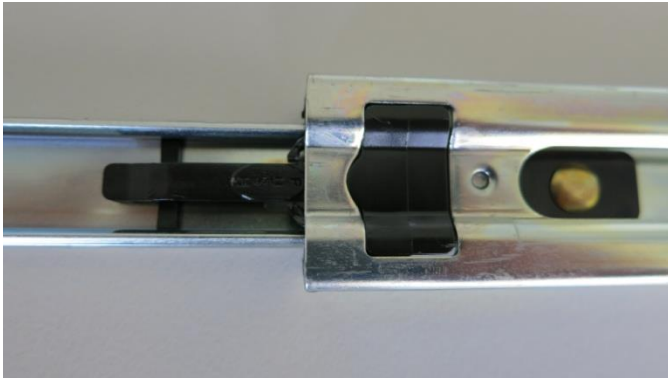

**Figure 67 – Separate Rack Slides**

3. Attach the inner slide rails to each side of the instrument using M4 x 10 button screws; three on each side (refer to Figure 68).



**Figure 68 – Assemble Inner Slide on Chassis**

4. Install rack mount ears on the front of the instrument using two M4 x 10 screws on each side (refer to Figure 69).



**Figure 69 – Rack Mount Ears Fitted to Instrument**

5. Attach the rack mount adaptors to the ends of the outer slide rails using M4 x 10 button screws, washers and locknuts. Do not fully tighten at this stage as minor adjustments will be required to suit the length of the rack (refer to Figure 70).



**Figure 70 – Attach Rack Mount Adaptors to Outer Slides**

6. Test fit the rack slide into your rack to determine the spacing of the rack mount adaptors.



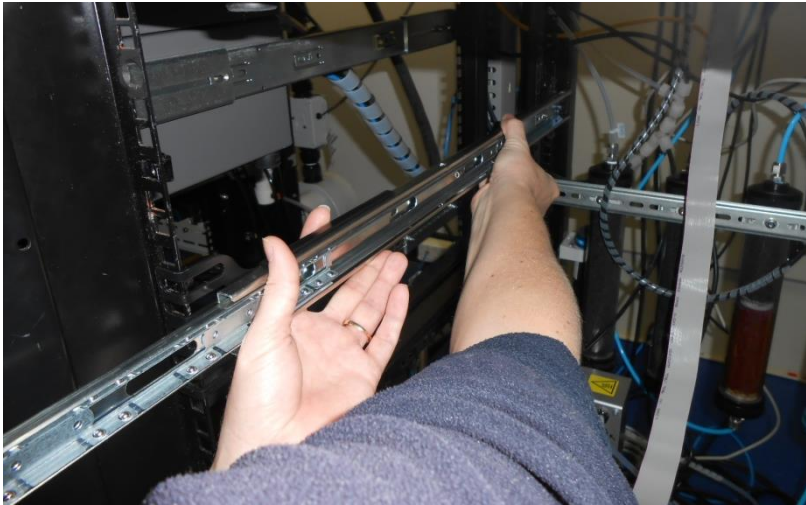

**Figure 71 – Test Fit the Rack Slide Assembly into Your Rack**

7. Install the two assembled outer slide rails onto the left and right side of the rack securely with M6 bolts; washer and locknuts/cage nuts (refer to Figure 72).

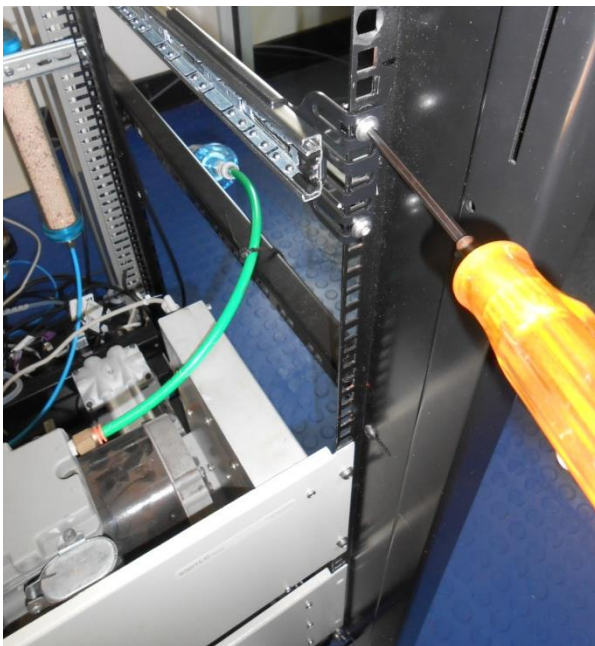

**Figure 72 – Attach Slides to Front of Rack**

8. Now carefully insert the instrument into the rack by fitting the instrument slides into the mounted rails. Ensuring that the rack slide locks engage on each side (you will hear a click from both sides).



**CAUTION**

When installing this instrument ensure that appropriate lifting equipment and procedures are followed. It is recommended that two people lift the instrument into the rack due to the weight, unless proper lifting equipment is available.

**Note:** Ensure both sides of the inner slide are attached to the outer slides before pushing into the rack fully.

9. Push the instrument into the rack. Adjust and tighten the screws as required to achieve a smooth and secure slide.

### To Remove the Instrument

1. To remove the instrument first pull instrument forward of rack giving access to the slides.
2. Find the rack slide lock labelled **Push** and push it in whilst sliding the instrument out of the rack, complete this for both sides while carefully removing instrument.

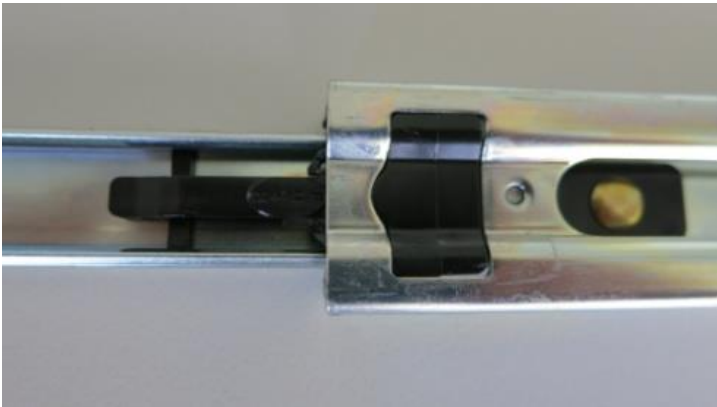

**Figure 73 – Slide Clips**

---

## 8.4 High Pressure Zero/Span Valves

---

High pressure span calibration valve (factory installed) PN: E020108

High pressure zero calibration valve (factory installed) PN: E020109

**Note:** Before using a high pressure span or zero as a source calibrating the instrument, please check with your local regulatory requirements.

Please refer to Section 5.8 for operation of this installed option.

Please refer to Section 9.10 for exploded assembly drawing.

## 9. Parts List

### 9.1 Serinus Accessories Kit

This kit contains assorted fittings, tubing and an orifice removal tool which are useful when working on the instruments internal pneumatics. This is usually purchased with the instrument

**Table 9 – Serinus Accessories Kit (PN: H010136)**

Part Description	Quantity	Part Number
Kynar Union Tee Fitting	4	F030007
Kynar Union Fitting	2	F030008
Adapter, 1/4" Fitting to 1/8" Barb	4	H010007
Adapter, 1/4" Tube to 1/8" Barb	2	H010008
Orifice Extraction Tool	1	H010046
Ecotech Tygon Tubing (1/4" OD, 1/8" ID (Clear))	3 Feet	T010011
Neoprene Tubing (1/4" OD, 1/8" ID (Black))	3 Feet	T010021

### 9.2 Maintenance Kit

This maintenance kit is required when performing annual maintenance on the instrument. Depending on the environment that the instrument is operating, this maintenance may need to be carried out more often than yearly.

**Table 10 – Annual Maintenance Kit – (PN: E020203-01)**

Part Description	Quantity	Part Number
Silicone Heatsink Compound	1	C050013
O-Ring (0.364 ID X 0.070 W)	2	O010010
O-Ring (5/32" ID X 1/16"W)	3	O010013
O-Ring, (1 11/16" ID X 3/32" W)	2	O010014
O-Ring, (1/4" ID X 1/16" W)	2	O010015
Viton O-Ring (13/16" ID X 1/16" W)	2	O010016
Viton O-Ring (BS015)	4	O010023
Ecotech Tygon Tubing (1/4" OD X 1/8" ID (Clear))	3 Feet	T010011

### 9.3 Consumables

Parts shown as consumables below will require replacement over the course of the instrument’s lifespan. This does not include parts that have already included in annual maintenance kits (bottom of Table 11).

**Table 11 – Consumables**

Part Description	Part Number
47mm, 5 micron, Teflon Filter Paper, Pack of 50	F010006-01
47mm, 5 micron, Teflon Filter Paper, Pack of 100	F010006
Background Scrubber DAU	F010033
Sample DFU	F010034
External Pump Repair Kit (To Suite a 607 Pump)	P031001
Internal Pump Repair Kit (To Suit KNF Pump)	P031005
Ecotech Tygon Tubing, 25ft Length	T010011-01
Annual Maintenance Kit	E020209

**\*Warranty Disclaimer:** The product is subject to a warranty on parts and labour from date of shipment (the warranty period). The warranty period commences when the product is shipped from the factory. **Lamps, fuses, batteries and consumable items are not covered by this warranty.**

Subject to use refers to variable ambient conditions, toxic gases, dirt, extremes of temperature and moisture ingress may shorten the lifespan of components.

### 9.4 Instrument Parts List

List of components and part numbers for reference.

**Table 12 – Spare Parts List**

Part Description	Part Number
Main Controller PCA	E020230-01
Serinus Power Supply, Auto-ranging	P010013
Measurement Cell Assembly	H015000
Measurement Cell, Mirror	H015006
Measurement Cell, Optical Lens	H015007
Measurement Cell, Optical Bandpass filter 450 nm	H015008
Measurement Cell, Inlet/Outlet Fittings	H015014
Measurement Cell, Nylon Grub screw	F050107
Measurement Cell, 0.01 Micron DFU Nylon (exhaust)	F010031
Measurement Cell, 0.01 Micron DFU PVDF (inlet)	F010032

Part Description	Part Number
Background Scrubber DAU	F010033
Sample DFU	F010034
O-Ring (1/4" ID x 1/6" W)	O010015
Viton O-Ring (BS210)	O010045
Calibration Valve Manifold	H010013-01
Heater Thermistor Assembly (Flow Block)	C020073
Heater Thermistor Assembly (Measurement Cell)	C020093
Gasket for Pressure Sensor	H010037
Swagelok Elbow Union	28170400-3
Rear Panel PCA	C010002
Pressure Sensor PCA	C010004
LED Light Source	C010022-05
Mixer Preamp PCA	C010047
Interface PCA	C010048
Display Ribbon Cable	C020065
Rear Panel PCA Ribbon Cable	C020066
Heater Extension Cable	C020094
Bluetooth Cable	C020119
Interface Cable	C020136
Mixer Preamp Cable	C020137
Adapter, 1/4" Fitting to 1/8" Barb	H010007
Kynar Elbow 1/8" NPT to 1/8" Barb	F030005
Kynar Male Connector 1/8" NPT to 1/8" Barb	F030006
Kynar Bulkhead Union 1/4" T	F030023
Extraction Tool to Remove Orifice and Sintered Filter With O-Ring Groove	H010046
Internal Pump Assembly	H010027
USB Memory Stick	H030021
Flow Block Assembly	H013165
Sample Filter Holder	H010020
Dryer	H015020
#10 Orifice – Used In The Dryer	H010043-09
Stop Valve	H030170
Serinus 60 User Manual	M010060

## 9.5 Plumbing Schematic – (PN: D020060)

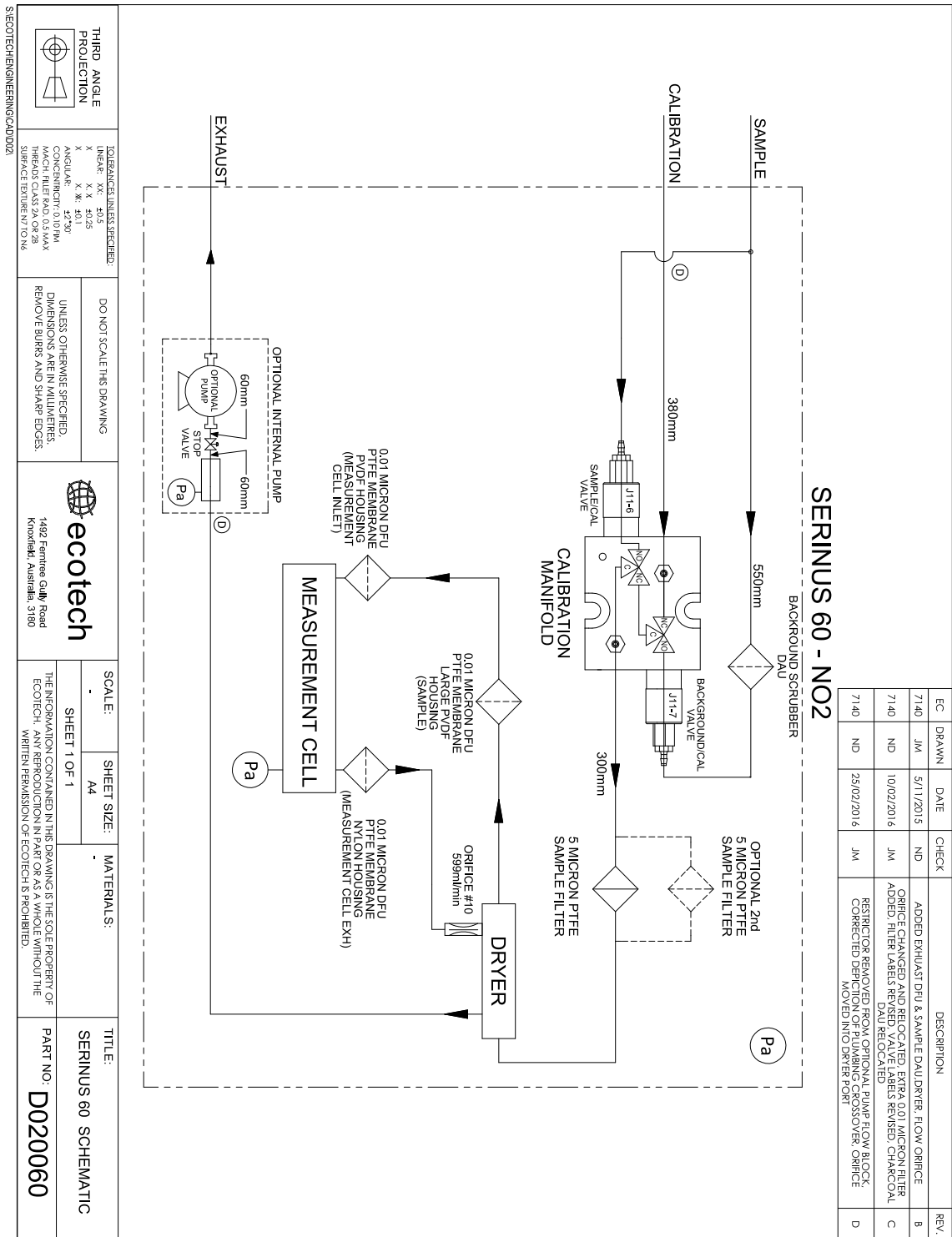

## 9.6 Block Wiring Schematic – (PN: D020111)

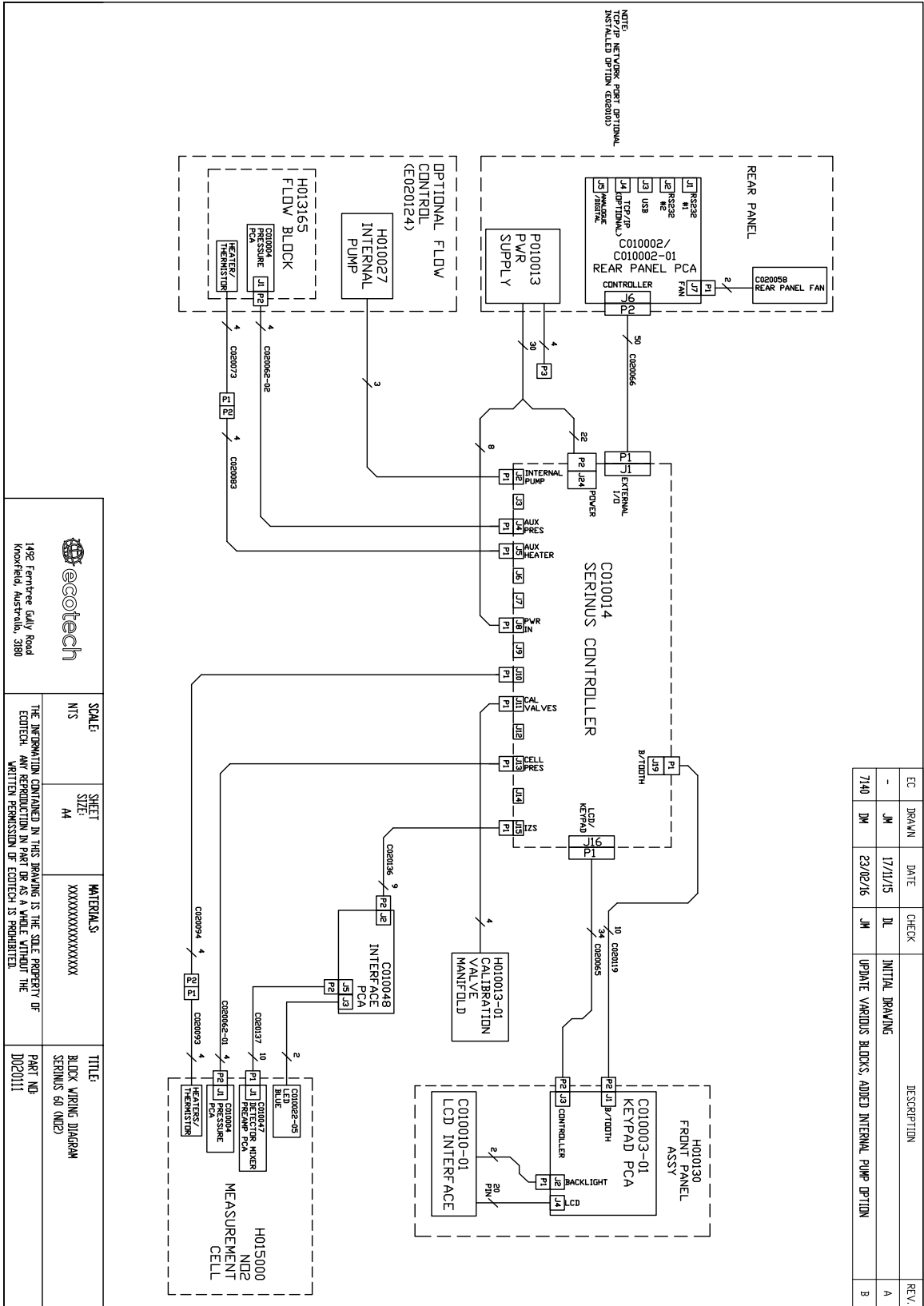

EC	DRAWN	DATE	CHECK	DESCRIPTION	REV.
-	JM	17/11/15	DL	INITIAL DRAWING	A
7140	JM	23/02/16	JM	UPDATE VARIOUS BLOCKS, ADDED INTERNAL PUMP OPTION	B

<p>1492 Fernthee Gully Road Knoxfield, Australia, 3180</p>		<p><b>SCALE:</b> N1S</p> <p><b>SHEET SIZE:</b> A4</p> <p><b>MATERIALS:</b> XXXXXXXXXXXXXXXXXXXX</p>	<p><b>TITLE:</b> BLOCK WIRING DIAGRAM SERINUS 60 (ND2)</p> <p><b>PART NO:</b> D020111</p>
<p>THE INFORMATION CONTAINED IN THIS DRAWING IS THE SOLE PROPERTY OF ECOTECH. ANY REPRODUCTION IN PART OR AS A WHOLE WITHOUT THE WRITTEN PERMISSION OF ECOTECH IS PROHIBITED.</p>			

## 9.7 Measurement Cell Side Section – (PN: H015000)

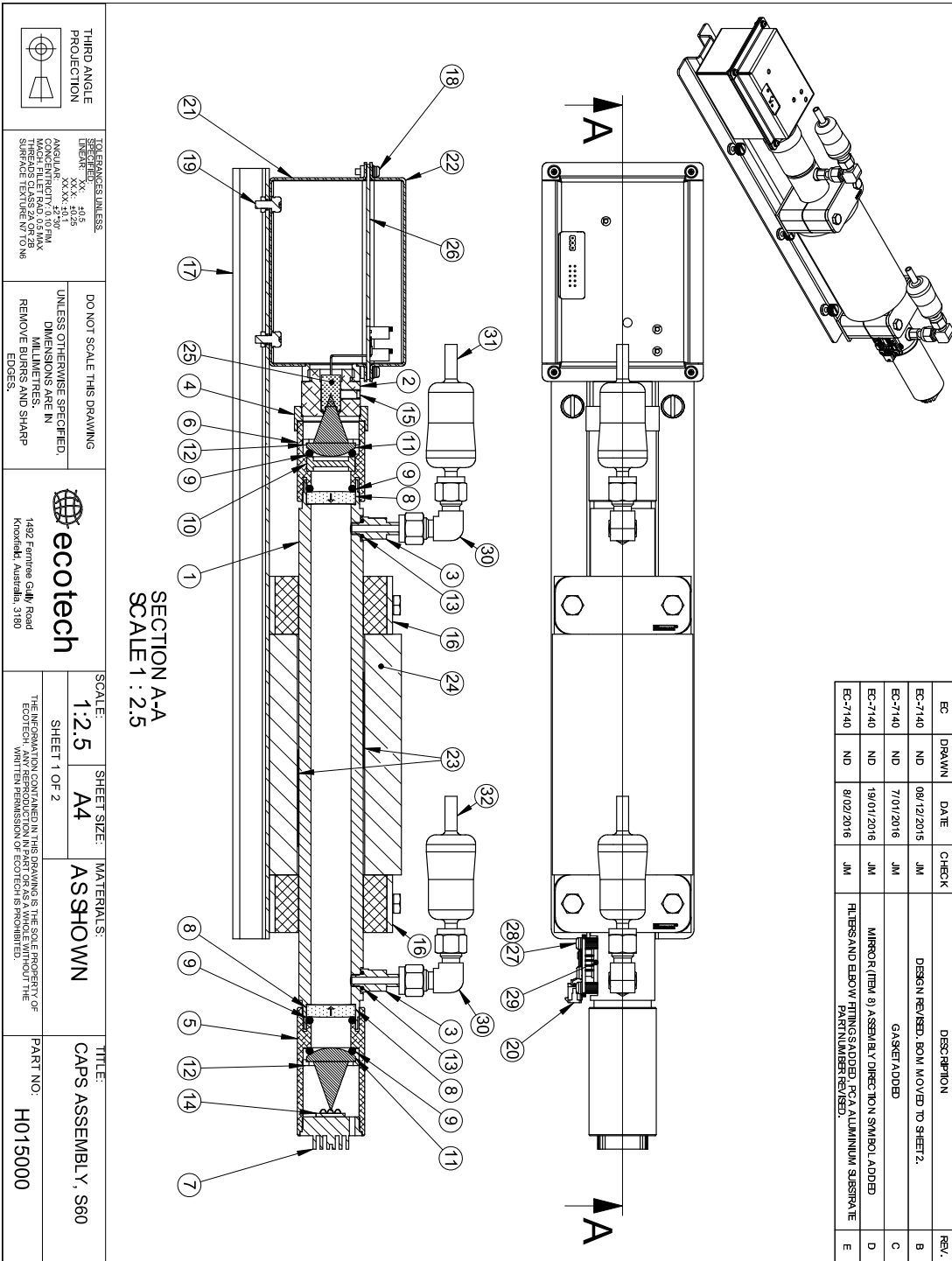



ITEM NO.	PART NUMBER	DESCRIPTION	QTY.
1	H015001	OPTICAL CELL	1
2	H015012	DETECTOR HOLDER	1
3	H015014	CELL FITTINGS	2
4	H015005	LIGHT DETECTOR SEAL	1
5	H015002	MIRROR HOLDER, LED END	1
6	H015003	MIRROR HOLDER, DETECTOR END	1
7	H015004	LED MOUNT	1
8	H015006	MIRROR	2
9	O010045	O-RING, BS-210, VITON	4
10	H015008	OPTICAL FILTER, 450nm CWL, 10nm BANDWIDTH	1
11	H015007	OPTICAL FOCUS LENS, VIS/NIR COATING	2
12	H015009	OPTICAL FILTER RETAINING RING, 25.4mm	2
13	O010015	O-RING 1/4ID X 1/16W, VITON	2
14	C010022-05	PCA ALUMINIUM SUBSTRATE	1
15	F050107	GRUB SCREW, NYLON, M5 X 10 LONG	1
16	H015015	CLAMP, CELL MOUNTING, STAUFF, TO SUIT S60	2
17	H015016	MOUNTING PLATE, CELL ASSY, CAPS, NO2	1
18	F050010	M3X10 SEMI PAN HEAD PHILLIPS SCREW	4
19	F050012	M4 X 10 SEMS	2
20	C010004	PCA, PRESSURE GAUGE GAS ANALYZER	1
21	H015018	BASE WELDMENT, SHEET METAL, DETECTOR BOX	1
22	H015017	COVER, SHEET METAL, DETECTOR BOX	1
23	C020093	HEATER AND THERMISTOR ASSY, DUAL SURFACE HEATER	1
24	H030075	INSULATION, FOAM, 35mm ID x 19mm WALL	0.125m
25	H015010	PHOTO TUBE RA14	1
26	C010047	PCA, S60 MIXER PREAMP	1
27	FAS-M3ZP-4	M3X12 PAN HEAD PHILLIPS SCREW	4
28	FAS-M3ZP-20	M3 SPRING WASHER	4
29	H010037	GASKET, PRESSURE SENSOR	1
30	28170400-3	FITTING, SMAGBLOK UNION ELBOW 1/4TS/S	2
31	F010031	FILTER, DPU, 0.01 MICRON, PTFE, NYLON HOUSING	1
32	F010032	FILTER, DPU, 0.01 MICRON, PTFE, PVDF HOUSING KYNAR	1



THIRD ANGLE PROJECTION

DO NOT SCALE THIS DRAWING UNLESS OTHERWISE SPECIFIED. DIMENSIONS ARE IN MILLIMETRES. REMOVE BURNS AND SHARP EDGES.



1492 Farnbee Gully Road  
Knoxfield, Australia 3180

SCALE: N/A SHEET SIZE: A4

MATERIALS: AS SHOWN

TITLE: CAPS ASSEMBLY, S60

PART NO.: H015000

THE INFORMATION CONTAINED IN THIS DRAWING IS THE SOLE PROPERTY OF ECOTECH. WRITTEN PERMISSION OF ECOTECH IS PROHIBITED.

S:\ECOTECH\ENGINEERING\CAD\H01

## 9.8 Calibration Valve Manifold Assembly Exploded View – (PN: H010013-01)

VALVE 1  
CABLE LENGTH 190 mm  
CONNECT TO PINS 1 AND 6  
ON THE CONNECTOR

VALVE 2  
CABLE LENGTH 250 mm  
CONNECT TO PINS 2 & 7  
ON THE CONNECTOR

CABLE TIE  
2-PLACES

MICROFIT RECEPTACLE  
FREE TO WAY MOLEX

NOTES:  
1. VALVES MUST BE FREE OF DIRT, GREASE OR ANY OTHER FOREIGN MATERIAL.  
2. 18230-J1A THREADS MUST BE SEALED WITH SWAGelok THREAD TAPE.  
3. MANIFOLD BLOCK MUST BE FREE OF DIRT GREASE OR ANY OTHER FOREIGN MATERIAL. ASSEMBLY MUST PASS LEAK TEST UNDER VACUUM OF -90 KPA. MAX DROP ALLOWED IS 2 KPA IN 5 MINS.  
4.

EC	DRAWN	DATE	CHECK	DESCRIPTION	REV.
	VC	16/03/10		INITIAL DRAWING	X1
	BP	22/09/2014	JM	BOM ADDED	8
	ND	9/11/2015	JM	COMPANY LOGO UPDATED IN TITLE BLOCK	C

ITEM NO.	PART NUMBER	DESCRIPTION	QTY.
1	H010014-01	VALVE MANIFOLD	1
2	H010042	VALVE MFLD. 3 WAY. 12VDC	2
3	F030006	FITTING, MALE CONNECTOR 1/8NPT - 1/8 BARB, KYNAR	4

THIRD ANGLE PROJECTION

TOLERANCES UNLESS SPECIFIED:  
LINEAR: XX: ±0.5  
X: ±0.25  
X X: ±0.25  
ANGULAR: °: ±30'  
CONCENTRICITY: 0.10 MM  
MATCH FILET RADIUS 0.5 MAX  
HATCH CLASS ZA OR ZB  
SURFACE FINISH: 10/16

DO NOT SCALE THIS DRAWING

UNLESS OTHERWISE SPECIFIED, DIMENSIONS REFER TO DIMETERS. REMOVE BURRS AND SHARP EDGES.

ecotech  
1492 Farnree Gully Road  
Knoxfield, Australia, 3180

SCALE: NTS  
SHEET 1 OF 1

THE INFORMATION CONTAINED IN THIS DRAWING IS THE SOLE PROPERTY OF ECOTECH. WRITTEN PERMISSION OF ECOTECH IS PROHIBITED.

TITLE: CALIBRATION VALVE MANIFOLD  
PART NO.: H010013-01

## 9.9 Valve Assembly Exploded View – (PN: H010042)

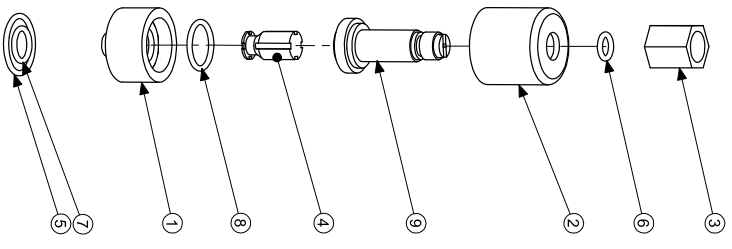

ITEM NO.	PART NUMBER	QTY.
1	BODY	1
2	SOLENOID COIL	1
3	NUT	1
4	PLUNGER	1
5	O010016	1
6	O010015	1
7	O010010	1
8	O010023	1
9	Stem	1

**STEPS TO REPLACE O-RINGS**

1. MARK THE SOLENOID COIL WITH A PERMANENT MARKER TO IDENTIFY THEIR RESPECTIVE VALVES AND THEIR POSITION ON MANIFOLD BLOCK
2. SECURE THE 3-WAY VALVE UPRIGHT INTO A LARGE VICE WITH PROTECTION AROUND ITS BODY TO PREVENT SCRATCH OR DAMAGE TO VALVE
3. REMOVE NUT FROM THE TOP OF THE 3-WAY VALVE USING A 9/16" SPANNER
4. REMOVE SMALL O-RING FROM AROUND 3 WAY VALVE USING 2 MM FLAT SCREW DRIVER
5. LIFT OFF THE SOLENOID COIL FROM THE 3-WAY VALVE THEN UNSCREW THE SHAFT FROM THE BASE USING A LARGE FLAT SCREW DRIVER WHILE UNSCREWING TAKE CARE THAT THE INTERNAL PLUNGER DOES NOT FALL OUT
6. REPLACE THE INTERNAL O-RING WITH O010023
7. ASSEMBLE THE SHAFT ALONG WITH PLUNGER BACK IN ITS POSITION
8. ASSEMBLE THE SOLENOID WITH ITS RESPECTIVE VALVE
9. ASSEMBLE NEW O010015 O-RING SUPPLIED
10. ASSEMBLE THE NUT ON TOP OF 3-WAY VALVE
11. ASSEMBLE O010016 AND O010010 O-RINGS ON THE BOTTOM OF THE VALVE
12. ASSEMBLE VALVE BACK IN MANIFOLD BLOCK

H010042  
3 WAY VALVE SERVICE PROCEDURE

## 9.10 High Pressure Valve Exploded View – (PN: H050043)

EC	DRAWN	DATE	CHECK	DESCRIPTION	REV.
	JM	04/12/2015	ND	INITIAL ISSUE	A

INSTRUMENT TYPE	ORIFICE PART NO.
S10 (O3)	H010043-09
S30/S31 (CO / CO2)	H010043-13
S40 (NOX)	H010043-11
S40H (NOX HIGH LEVEL)	H010043-03
S44 (NH3/NOX)	H010043-11
S5X (SO2, H2S/SO2, H2S, TS, TRS)	H010043-13

ITEM NO.	PART NUMBER	DESCRIPTION	QTY.
1	BASE	BASE, VALVE, 2 WAY, 12 VDC	1
2	O010023	O-RING BS038, SILICONE	1
3	NUT	NUT, VALVE, 2 WAY, 12 VDC	1
4	COIL	SOLENOID COIL, VALVE, 2 WAY, 12 VDC	1
5	PLUNGER	PLUNGER, VALVE, 2 WAY, 12 VDC	1
6	STEM	STEM, VALVE, 2 WAY, 12 VDC	1
7	WASHER	WASHER, VALVE, 2 WAY, 12 VDC	1
8	F030006	FITTING, MALE CONNECTOR 1/8NPT - 1/8 BARB, KYNAR	1
9	28590462-3	Male Adapter (Tapered Thread)	1
10	98300076	FITTING, BULKHEAD, 1/4T S/S, MODIFIED	1
11	H010043-XX	ORIFICE	1
12	O010013	O-RING 5/32ID X 1/16W, VITON	1

<p>THIRD ANGLE PROJECTION</p>	<p>UNLESS OTHERWISE SPECIFIED, DIMENSIONS ARE IN MILLIMETERS REMOVE BURRS AND SHARP EDGES.</p>	<p>DO NOT SCALE THIS DRAWING UNLESS OTHERWISE SPECIFIED</p>	<p>SCALE: 1:2</p>	<p>SHEET SIZE: A4</p>	<p>MATERIALS: AS PER BOM</p>	<p>TITLE: VALVE ASSY, HIGH PRESSURE, SERINUS</p>
<p>1492 Fairtree Quay, Road Knookicki, Australia, 3180</p> <p>ecotech</p> <p>SHEET 1 OF 1</p> <p>THE INFORMATION CONTAINED IN THIS DRAWING IS THE SOLE PROPERTY OF ECOTECH. ANY REPRODUCTION IN PART OR AS A WHOLE WITHOUT THE WRITTEN PERMISSION OF ECOTECH IS PROHIBITED.</p> <p>PART NO: H050043</p>						

S:\ECOTECH\ENGINEERING\CAD\H05

## Appendix A. Advanced Protocol

The Advanced protocol allows access to the full list of instrument parameters.

### A.1 Command Format

All commands and responses sent to and from the Instrument will be in the following packet format to ensure data is reliable.

**Table 13 – Packet Format**

1	2	3	4	5	6 ... 5+n	6+n	7+n
STX (2)	Serial ID	Command	ETX (3)	Message Length (n)	Message	Checksum	EOT (4)

Where:

<STX> ASCII Start of Text = 0x02 hex.

Serial ID The Serial ID assigned in the Main Menu → Communications Menu → Serial Communication Menu.

<ETX> ASCII End of Text = 0x03 hex.

Checksum The XOR of the individual bytes except for STX, ETX, EOT and Checksum.

Message length Must be in the range 0 to 32. Responses from the instrument can have a message Length of 0 to 255.

<EOT> ASCII End of Transmission = 0x04 hex.

### Examples

A basic request for Primary gas data would be as follows:

**Table 14 – Example: Primary Gas Request**

Byte Number	1	2	3	4	5	6	7	8
Description	STX	ID	Command	ETX	Message Length	Primary Gas Conc	Checksum	EOT
Value	2	0	1	3	1	50	50	4
Checksum Calculation		0	0⊕1=1		1⊕1=0	0⊕50=50	50	

And a sample response:

**Table 15 – Example: Primary Gas Response**

Byte Number	1	2	3	4	5	6	Continued in next table.
Description	STX	ID	Command	ETX	Message Length	Primary Gas Conc	
Value	2	0	1	3	5	50	
Checksum Calculation		0	$0 \oplus 1 = 1$		$1 \oplus 5 = 4$	$4 \oplus 50 = 54$	

**Table 16 – Example: Primary Gas Response (continued)**

Byte Number	7	8	9	10	11	12
Description	IEEE representation of 1.00				Checksum	EOT
Value	63	128	0	0	50	4
Checksum Calculation	$54 \oplus 63 = 9$	$9 \oplus 128 = 137$	$137 \oplus 0 = 137$	$137 \oplus 0 = 137$	137	

## A.2 Commands

### A.2.1 Communication Error

Where:

Command byte        0

Message byte 1       0

Message byte 2       0..7

If the command byte of a response is 0, this indicates an error has occurred. The message field will be 2 bytes long, where the 2<sup>nd</sup> byte indicates the error according to the following table.

**Table 17 – List of Errors**

Error #	Description
0	Bad Checksum received
1	Invalid Parameter Length
2	Invalid Parameter
3	Internal Data Flash Erase in Progress unable to return data for a few seconds
4	Unsupported Command.
5	Another process is collecting data – unable to service request.
6	MemStick No Connected
7	MemStick Busy

### A.2.2 Get IEEE Value

Where:

- Command byte        1
- Message byte 1        Index from List of Parameters
- Message byte 2..32    Additional indexes (optional)

This command requests the value of an instrument parameter. The message field byte contains the index of the parameter requested, as described in the List of Parameters.

Up to 32 indexes can be supplied in a single request. The response has 5 bytes for each parameter requested – the first byte is the parameter index and the next four are the IEEE representation of the current value.

#### Example

A request with a message field of 50,51,52 to a Serinus S40 would return a 15 byte message as shown below:

**Table 18 – Example: Get IEEE Response data**

1	2	3	4	5	6	7	8	9	10	11	12	13	14	15
50	NO reading				51	NOx reading				52	NO2 reading			

### A.2.3 Set Calibration Mode

Where:

- Command byte        4
- Message byte 1        85
- Message byte 2-5     The IEEE representation of 0, 1, 2, or 3
  - 0 puts the instrument into Measure mode (0,0,0,0)
  - 1 puts the instrument into Cycle mode (63,128,0,0)
  - 2 puts the instrument into Zero mode (64,0,0,0)
  - 3 puts the instrument into Span mode (64,64,0,0)

This command puts the instrument into a calibration mode (the same as going to the Calibration menu and choosing a Cal. Mode).

#### Example

A request with a command of 4 and a message field of 85,64,64,0,0 would place the instrument into Span mode.

### A.2.4 Set Calibration

Enters a new calibration value: the same as entering Span Calibrate or Zero Calibrate on the calibration menu.

Where:

- Command byte            18
- Message byte 1        0, 1, 2, or 3 where
- 0 = Span
- 1 = Zero (first zero gas)
- 2 = Zero (second zero gas)
- 3 = Zero (Third zero gas)
- Message byte 2-5        The IEEE representation of the calibration value.

## A.3 List of Parameters

**Note:** Parameters are for all Serinus series analysers and may not be applicable to an individual instrument.

**Table 19 – Advanced Protocol Parameter List**

#	Description	Notes
1	Cal/Zero Valve	0 = Zero, 1 = Cal
2	Internal Span Valve	0 = Off, 1 = On
3	Positive Supply	Positive analog supply voltage
4	Gas 5 Avg.	Average of the readings (for Gas 5) of the last n minutes where n is the averaging period E.g. Nx
5	Pregain	S30H linearization coefficient gain
6	Sample/Cal Valve	0 = Sample, 1 = Cal/Zero
7	NOx Measure Valve	0 = NO, 1 = NOx
8	NOx Bypass Valve	0 = NO, 1 = NOx
9	NOx Backgnd Valve	0 = Off, 1 = On
10	Valve Sequencing	0 = Off, 1 = On
11	LCD Contrast Pot	0 = Lightest, 255 = Darkest
12	SO2 Ref Zero Pot	S50 Reference zero pot
13	CO Input Pot	S30 Input pot
14	CO Reference Test Pot	Not Used



15	CO Measure Pot	Not Used
16	High Volt Adjust Pot	PMT High Voltage Adjust Pot for S50 & S40
17	SO2 Lamp Adjust Pot	S50 Lamp adjustment Pot
18	O3 Lamp Adjust Pot	S10 Lamp adjustment Pot
19	O3 Meas. Zero Pot (C)	S10 Signal zero measure (coarse)
20	O3 Meas. Zero Pot (F)	S10 Signal zero measure (fine)
21	PMT Fan Pot	Optical Bench fan speed control pot
22	Rear Fan Pot	Chassis Fan speed control pot
23	Pump Fine Pot	Internal Pump speed fine pot
24	Pump Coarse Pot	Internal Pump speed coarse pot
25	Analog input 0	SO2 Reference signal
26	Analog input 1	CO Reference signal
27	Analog input 2	O3 Reference signal
28	Analog input 3	SO2 & O3 Lamp current
29	Analog input 4	Flow block pressure
30	Analog input 5	Cell pressure
31	Analog input 6	Ambient pressure
32	Analog input 7	Raw ADC calibration input
33	Analog input 8	Reserved
34	Analog input 9	Concentration data
35	Analog input 10	Reserved
36	Analog input 11	Reserved
37	Analog input 12	Raw analog to digital count for external analog input 0. 0-5V= 0-32766 A/D counts
38	Analog input 13	Raw analog to digital count for external analog input 1. 0-5V= 0-32766 A/D counts
39	Analog input 14	Raw analog to digital count for external analog input 2. 0-5V= 0-32766 A/D counts
40	Analog input 15	Reserved
41	CO Meas. Zero Pot (coarse)	S30 Measure ZERO coarse adjustment Pot
42	CO Meas. Zero Pot (fine)	S30 Measure ZERO fine adjustment Pot
43	SO2 Input Pot	SO2 Measure Signal Gain Pot
44	SO2 Ref. Gain Pot	SO2 Reference Signal Gain Pot
45	SO2 Meas. Zero Pot	SO2 Measure zero pot
46	O3 Input Pot	O3 Input signal gain pot

47	Diagnostic Test Pot	The Diagnostic mode adjustment pot for all the analysers except for S30
48	NOx Input Pot	PMT signal input gain control FOR NOx
49	PGA Gain	1, 2, 4, 8, 16, 32, 64, 128
50	Gas 1 Inst.	Primary gas concentration currently displayed on the front screen E.g. NO
51	Gas 2 Inst.	Secondary gas concentration currently displayed on front screen E.g. NOx
52	Gas 3 inst.	Calculated gas concentration currently displayed on front screen E.g. NO2
53	Gas 1 Avg.	Average of the readings (for Gas1) of the last n minutes where n is the averaging period
54	Gas 2 Avg.	Average of the readings (for Gas2) of the last n minutes where n is the averaging period
55	Gas 3 Avg.	Average of the readings (for Gas3) of the last n minutes where n is the averaging period
56	Instrument Gain	Current calibration value (default is 1.0)
57	Serial ID	Multidrop or Bayern-Hessen gas id
58	Bayern-Hessen ID	For multigas instruments only
59	Decimal Places	2-5
60	Noise	Instrument noise
61	Gas 1 Offset	An offset applied to Gas 1
62	Gas 3 Offset	An offset applied to Gas 3
63	Flow Temperature	Temperature of the flow block
64	Lamp Current	Lamp current in mA E.g 35mA
65	Digital Supply	Digital Supply voltage (should always read close to 5 volts)
66	Conc. Voltage	Concentration Voltage
67	High Voltage	High Voltage reading for PMT
68	Ozonator	0 = Off, 1 = On
69	Control Loop	0 = Off, 1 = On (default is On)
70	Diagnostic Mode	0 = Operate 1 = Preamp 2 = Electrical 3 = Optical (default is Operate)
71	Gas Flow	Units in slpm
72	Gas Pressure	Units in torr
73	Ambient Pressure	Units in torr

74	12V Supply	The 12 volt Power supply voltage								
75	Cell Temperature	Cell Temperature								
76	Conv. Temperature	Converter Temperature								
77	Chassis Temperature	Chassis Temperature								
78	Manifold Temp.	Manifold Temperature								
79	Cooler Temperature	Cooler Temperature								
80	Mirror Temperature	Mirror Temperature								
81	Lamp Temperature	Lamp Temperature								
82	IZS Lamp Temperature	O3 Lamp Temperature								
83	Instrument Status									
84	Reference Voltage	Units in Volts								
85	Calibration State	This variable has two different sets of values:								
		<table border="1"> <tr> <td>Set Calibration State</td> <td>Get IEEE Value</td> </tr> <tr> <td>0 = MEASURE</td> <td>0 = MEASURE</td> </tr> <tr> <td>1 = CYCLE</td> <td>1 = ZERO</td> </tr> <tr> <td>2 = ZERO</td> <td>2 = SPAN</td> </tr> <tr> <td>3 = SPAN</td> <td></td> </tr> </table>	Set Calibration State	Get IEEE Value	0 = MEASURE	0 = MEASURE	1 = CYCLE	1 = ZERO	2 = ZERO	2 = SPAN
Set Calibration State	Get IEEE Value									
0 = MEASURE	0 = MEASURE									
1 = CYCLE	1 = ZERO									
2 = ZERO	2 = SPAN									
3 = SPAN										
86	Primary Raw Conc.	(For S40, before NOx background and gain)								
87	Secondary Raw Conc.	Only for multigas instruments (For S40, before NOx background and gain)								
88	S40 Backgnd Conc.	NOx Background Concentration (For S40, before gain)								
89	Cal. Pressure	Calibration Pressure								
90	Conv. Efficiency	Converter Efficiency								
91	Multidrop Baud Rate	0 = 1200 bps 1 = 2400 bps 2 = 4800 bps 3 = 9600 bps 4 = 14400 bps 5 = 19200 bps 6 = 38400 bps								
92	Analog Range AO 1	Maximum range value for analog output								
93	Analog Range AO 2									
94	Analog Range AO 3									
95	Output Type AO 1	Output Type								
96	Output Type AO 2	1 = Voltage								
97	Output Type AO 3	0 = Current								

98	Anlg Ofst/Rng AO1	Voltage Offset /Current Range 0 = 0 % or 0-20mA 1 = 5 % or 2-20mA 2 = 10 % or 4-20mA
99	Anlg Ofst/Rng AO2	
100	Anlg Ofst/Rng AO3	
101	F/Scale Volt AO 1	5.0 Volt Calibration value
102	F/Scale Volt AO 2	
103	F/Scale Volt AO 3	
104	Z Adj Volt AO 1	0.5 Volt Calibration value
105	Z Adj Volt AO 2	
106	Z Adj Volt AO 3	
107	Negative Supply	Negative analog supply
108	Digital Outputs	A single byte expressing the most recent state of the digital outputs
109	Digital Inputs	A single byte expressing the most recent state of the digital inputs

110	Instrument State	0 = SAMPLE FILL 1 = SAMPLE MEASURE 2 = SAMPLE FILL AUX 3 = SAMPLE MEASURE AUX 4 = SAMPLE FILL AUX2 5 = SAMPLE MEASURE AUX2 6 = BACKGROUND FILL 7 = BACKGROUND MEASURE 8 = BACKGROUND PURGE 9 = BACKGROUND FILL AUX 10 = BACKGROUND MEASURE AUX 11 = ZERO FILL 12 = ZERO MEASURE 13 = ZERO FILL AUX 14 = ZERO MEASURE AUX 15 = ZERO FILL AUX2 16 = MEASURE AUX2 17 = BACKGROUND FILL ZERO 18 = BACKGROUND MEASURE ZERO 19 = SPAN FILL 20 = SPAN MEASURE 21 = SPAN FILL AUX 22 = SPAN MEASURE AUX 23 = SPAN FILL AUX2 24 = SPAN MEASURE AUX2 25 = BACKGROUND FILL SPAN 26 = BACKGROUND MEASURE SPAN 27 = BACKGROUND PURGE SPAN 28 = ELECTRONIC ZERO ADJUST 29 = INSTRUMENT WARM UP 30 = BACKGROUND ADJUST FILL 31 = BACKGROUND ADJUST MEASURE
111	CO Lin. Factor A	CO Linearisation Factor A
112	CO Lin. Factor B	CO Linearisation Factor B
113	CO Lin. Factor C	CO Linearisation Factor C
114	CO Lin. Factor D	CO Linearisation Factor D
115	CO Lin. Factor E	CO Linearisation Factor E

116	Instrument Units	0 = ppm 1 = ppb 2 = ppt 3 = mg/m <sup>3</sup> 4 = µg/m <sup>3</sup> 5 = ng/m <sup>3</sup> 6 = %
117	Backgnd Meas. Time	In seconds.
118	Sample Fill Time	These parameters can be changed, but only temporarily; restarting the instrument will restore them to their default values.
119	Sample Measure Time	
120	Aux Measure Time	
121	Aux Smpl. Fill Time	
122	Backgnd Fill Time	
123	Zero Fill Time	
124	Zero Measure Time	
125	Span Fill Time	
126	Span Measure Time	
127	O3 Gen Coeff D	
128	Backgnd Pause Time	In seconds
129	Bkgnd Intrleav Fact	
130	Cal. Pressure 2	Calibration Pressure for 2 <sup>nd</sup> gas
131	2nd Instrument Gain	Unused (always reports 1.0)
132	Background voltage	Units in Volts
133	Perm Rate	Permeation rate of the gas in ng/min
134	Perm Flow	Total flow past the permeation chamber during an activated internal span mode. In ml/min
135	Perm Oven Setpoint	Set target temperature for the permeation oven. Default is 50 °C
136	Perm Oven Temp	Temperature readout of the Permeation oven. Units in °C
137	Ozone Target	Ozone Target for S10 IZS ozone generation
138	Reserved	
139	Reserved	
140	Reserved	
141	Reserved	
142	Reserved	
143	IR Source	The S30 IR source voltage

144	Background (hrs)	The background interval in hours. 0.0 if disabled 0.25 for every 15 minutes 0.30 for every 20 minutes 0.50 for every 30 minutes 1.00 for every hour ... 24.00 for once a day
145	Cycle Time	In minutes
146	CO Cooler Pot	CO Cooler voltage adjustment POT
147	CO Source Pot	CO Source voltage adjustment POT
148	CO Test Meas. Pot	Diagnostics use only
149	CO Test Ref. Pot	Diagnostics use only
150	O3 Ref Average	S10 Background Average
151	PTF Correction (gas 1)	Pressure Temperature Flow Compensation Factor for first gas
152	PTF Correction (gas 2)	Pressure Temperature Flow Compensation Factor for second gas in dual gas analysers.
153	Inst. Cell Pressure	Instantaneous cell pressure
154	Manifold	Manifold Pressure in S40 instruments
155	Cell Press. (gas1)	Cell Pressure for Gas 1
156	Cell Press. (gas2)	Cell Pressure for Gas 2
157	Cell Press. (Bgnd)	Cell Pressure when in Background
158	Background	0 = the instrument is measuring a gas sample 1 = the instrument is measuring background air
159	Gas To Measure	S51 only; see Measurement Settings Menu 0 = Measure both gasses 1 = Measure SO2 only 2 = Measure H2S only
160	Valve States	Diagnostic use only
161	Temperature Units	0 = "°C" 1 = "°F" 2 = "K"
162	Pressure Units	0 = "torr" 1 = "psi" 2 = "mbar" 3 = "atm" 4 = "kPa"

163	Averaging Period	0 = "1 Min" 1 = "3 Mins" 2 = "5 Mins" 3 = "10 Mins" 4 = "15 Mins" 5 = "30 Mins" 6 = "1 Hr" 7 = "4 Hrs" 8 = "8 Hrs" 9 = "12 Hrs" 10 = "24 Hrs"
164	Filter Type	0 = NO FILTER 1 = KALMAN FILTER 2 = 10 SEC FILTER 3 = 30 SEC FILTER 4 = 60 SEC FILTER 5 = 90 SEC FILTER 6 = 300 SEC FILTER 7 = ADPTIVE FILTER
165	NO2 Filter enabled	0 = Disabled, 1 = Enabled
166	Background Interval	0 = 24 Hrs 1 = 12 Hrs 2 = 8 Hrs 3 = 6 Hrs 4 = 4 Hrs 5 = 2 Hrs 6 = Disable
167	Service (COM1) Baud	Serial baud rate
168	Multidrop (COM2) Baud	0 = 1200 bps 1 = 2400 bps 2 = 4800 bps 3 = 9600 bps 4 = 14400 bps 5 = 19200 bps 6 = 38400 bps
169	Service Protocol	0 = EC9800
170	Multidrop Protocol	1 = Bayern-Hessen 2 = Advanced 3 = Modbus
171	AO1 Over Range	The Upper Concentration Range when Over-Ranging is enabled
172	AO2 Over Range	
173	AO3 Over Range	



174	AO1 Over-Ranging	0 = Over Ranging Disabled 1 = Over Ranging Enabled 2 = Over Ranging enabled and currently active
175	AO2 Over-Ranging	
176	AO3 Over-Ranging	
177	Heater Set Point	Cell Heater Set Point units in °C
178	PMT High Volt. Pot	High voltage pot setting
179	PMT Test LED Pot	PMT Test LED intensity controller POT
180	Last Power Failure	Time Stamp of the Last power fail (4 byte time stamp) Bit 31:26 ---- Year (0 – 99) Bit 25:22 ---- Month (1 – 12) Bit 21:17 ---- Date (1 – 31) Bit 16:12 ---- Hour (00 – 23) Bit 11:06 ---- Min (00 – 59) Bit 05:00 ---- Sec (00 – 59)
181	Inst Manifld Pres.	Manifold Pressure in S40 instruments (instantaneous)
182	Cell Press. (gas5)	Cell Pressure for Gas 5 (Nx)
183	Gas 4 Inst.	Calculated gas concentration currently displayed on front screen E.g. NH3
184	Gas 4 Avg.	Average of the readings (for Gas 4) of the last n minutes where n is the averaging period E.g. NH3
185	Gas 5 Inst.	Calculated gas concentration currently displayed on front screen E.g. Nx
186	NH3 Conv. Efficiency	
187	Cell/Lamp Duty Cycle	
188	Mirror T. Duty Cycle	
189	Flow Temp Duty Cycle	
190	Cooler T. Duty Cycle	
191	Conv Temp Duty Cycle	
192	CO Conv T Duty Cycle	
193	F/Scale Curr AO 1	20 mA Calibration value
194	F/Scale Curr AO 2	
195	F/Scale Curr AO 3	
196	Z Adj Curr AO 1	4 mA Calibration value
197	Z Adj Curr AO 2	
198	Z Adj Curr AO 3	
199	Ext Analog Input 1	The value of the external analog input after the multiplier and offset have been applied
200	Ext Analog Input 2	

201	Ext Analog Input 3	
202	Conv Set Point	Converter Set Point
203	Cal. Pressure 3	Calibration Pressure 3
204	PTF Correction (gas 3)	Pressure Temperature Flow Compensation Factor for third gas in multi-gas instruments.
205	Dilution Ratio	The current dilution ratio (default is 1.0)
206	Traffic Light	State of the status light: 0 = Green 1 = Amber 2 = Off (normally impossible) 3 = Red
207	Network Protocol	0 = EC9800 1 = Bayern-Hessen 2 = Advanced 3 = Modbus
208	Gas 4 Offset	A offset applied to Gas 4
209	O3 GEN Fine Pot	Ozone generator control, DAC controlled. DAC: 0..64535
210	O3 Gen Lamp Current	Units in mA
211	O3 GEN Coarse Pot	Repeat of parameter 209
212	Logging Period	The data logging period, in seconds (1.. 86400)
213	O3 Gen Coeff A	Ozone generator coefficients Note that Coeff D is parameter 127
214	O3 Gen Coeff B	
215	O3 Gen Coeff C	
216	Meas. Count	S60 measure count
217	Sig. Count 1	S60 signal counts in 90° steps
218	Sig. Count 2	
219	Sig. Count 3	
220	Sig. Count 4	
221	Signal Voltage	S60 Signal voltage
222	LED Drive	S60 LED drive value

---

## Appendix B. EC9800 Protocol

The Serinus implements a subset of the 9800 instrument protocol. Only the basic commands of reading the concentration value and setting the instrument calibration state (measure, span or zero) are supported.

---

### B.1 Command Format

---

All commands are sent as ASCII strings. Fields are delimited by commas and the command ends with the normal return key (i.e. the TERMINATOR is either a <CR> or a <LF>). The DEVICE I.D. is the Serial ID assigned in the **Main Menu → Communications Menu → Serial Communication Menu**. If the instrument is not being used in a multi-drop connection, the DEVICE I.D> can be replaced with the string “???”.

---

### B.2 Commands

---

#### B.2.1 DCONC

Function: Sends the current instantaneous concentration data to the serial port.

Format: DCONC, {<DEVICE I.D.>} {TERMINATOR}

Device response: {GAS} <SPACE> {STATUS WORD} <CR><LF>

The GAS value is the concentration value in the current instrument units, expressed as a floating point number (i.e. 12.345). The STATUS WORD indicates the instrument status in hex (i.e. A01F) using the following format:

- Bit 15 = SYSFAIL (MSB)
- Bit 14 = FLOWFAIL
- Bit 13 = LAMPFAIL
- Bit 12 = CHOPFAIL
- Bit 11 = CVFAIL
- Bit 10 = COOLERFAIL
- Bit 9 = HEATERFAIL
- Bit 8 = REFFAIL
- Bit 7 = PS-FAIL
- Bit 6 = HV-FAIL
- Bit 5 = OUT OF SERVICE
- Bit 4 = Instrument is in zero mode
- Bit 3 = Instrument is in span mode
- Bit 2 = Unused
- Bit 1 = SET→PPM selected, CLEAR→MG/M3
- Bit 0 = reserved (LSB)

#### B.2.2 DSPAN

Function: Commands the instrument to enter span mode.

Format: DSPAN, {<DEVICE I.D.>} {TERMINATOR}

Device response: <ACK> if the instrument is able to perform the command, <NAK> if not.

### **B.2.3 DZERO**

Function: Commands the instrument to enter the zero mode.

Format: DZERO, {<DEVICE I.D.>} {TERMINATOR}

Device response: <ACK> if the instrument is able to perform the command, <NAK> if not.

### **B.2.4 ABORT**

Function: Commands the instrument to abort the current span/zero mode and return to measure mode.

Format: ABORT, {<DEVICE I.D.>} {TERMINATOR}

Device response: <ACK> if the instrument is able to perform the command, <NAK> if not.

### **B.2.5 RESET**

Function: Reboots the instrument (software reset).

Format: RESET, {<DEVICE I.D.>} {TERMINATOR}

Device response: <ACK>.

## Appendix C. Bayern-Hessen Protocol

The Serinus implements a limited subset of the Bayern-Hessen Network protocol. Only the ability to set the instrument calibration state (measure, span or zero) and read the gas concentrations are supported.

### C.1 Command Format

<STX><text><ETX>< bcc1><bcc2>

Where:

<STX> ASCII Start of Text = 0x02 hex.

<Text> ASCII text maximum length of 160 characters.

<ETX> ASCII End of Text = 0x03 hex.

<bcc1> ASCII representation of block check value MSB. (That is, the character “3” for 3, the character “F” for 15, etc.)

<bcc2> ASCII representation of block check value LSB.

The block check algorithm begins with 0 and exclusive-OR’s each ASCII character from <STX> to <ETX> inclusive. This block check value is converted to ASCII format and sent after the <ETX> character.

### Examples

This is an example of a valid Bayern-Hessen data request for an instrument that has a Serial ID of 97 (Serial ID assigned in the **Main Menu** → **Communications Menu** → **Serial Communication Menu**):

<STX>DA097<EXT>3A

The block check calculation is best shown by the following example:

**Table 20 – Bayern-Hessen Data**

Character	Hex Value	Binary	Block Check
<STX>	02	0000 0010	0000 0010
D	44	0100 0100	0100 0110
A	41	0100 0001	0000 0111
0	30	0011 0000	0011 0111
9	39	0011 1001	0000 1110
7	37	0011 0111	0011 1001
<ETX>	03	0000 0011	0011 1010

The binary value 0011 1010 corresponds to the hex value 3A. This value in ASCII forms the last two characters of the data request message.

Note: The I.D. of 97 is sent as the sequence 097. All I.D. strings must have three digits and must always be padded with ASCII zero characters.

This is an example of a valid command to put the unit in the manual span mode if the instrument has an ID of 843:

<STX>ST843 K<ETX>52

The block check operation is best shown with the following table:

**Table 21 – Block Check Operation**

Character	Hex Value	Binary	Block Check
<STX>	02	0000 0010	0000 0010
S	53	0101 0011	0101 0001
T	54	0101 0100	0000 0101
8	38	0011 1000	0011 1101
4	34	0011 0100	0000 1001
3	33	0011 0011	0011 1010
<SPACE>	20	0010 0000	0001 1010
K	4B	0100 1011	0101 0001
<ETX>	03	0000 0011	0101 0010

The binary block check value is 0101 0010 which is the hex value 52 as shown at the end of the command string.

---

## C.2 Commands

### C.2.1 DA

Return the current instantaneous concentration.

#### Command Format

<STX>{DA}{<kkk>}<ETX>< bcc1><bcc2>

Where:

kkk                      Device's ID. This field is optional, but if provided it must be padded with zeros to be 3 characters long. The value must match one of the following: the instrument's Bayern-Hessen ID, 000, or ??? (three question marks).

- bcc1 First byte of the block check calculation.
- bcc2 Second byte of the block check calculation.

**Device response**

The instrument responds with a variable length string, depending on how many measured gasses have been assigned an ID above 0. The text between the [ ] will be repeated once for each reported gas.

```
<STX>{MD}{cc}[<SP><kkk><SP><+nnnn+ee><SP><ss><SP><ff><SP><mmm><SP>eeeeee<SP>]<ETC><bcc1><bcc2>
```

Where:

- <SP> Space (0x20 hex).
- cc The number of gasses reported (0..5). The text in between the [ ] will be repeated once for each gas reported.
- kkk The Bayern-Hessen instrument ID.
- +nnnn+ee Gas concentration.
- ss Status byte (see table below for individual bits).
- ff Failure byte (see table below for individual bits).
- mmm Gas ID.
- eeeeee Ecotech instrument ID.
- bcc1 First byte of the block check calculation.
- bcc2 Second byte of the block check calculation.

**Table 22 – Status Bit Map**

Status Bit	Meaning if set to 1
0	Instrument off (this value is always set to 0).
1	Out of service.
2	Zero mode.
3	Span mode.
4	-
5	-
6	Units: 1 = Volumetric, 0 = Gravimetric.
7	Background mode (S30 and S50 family only).

**Table 23 – Failure Bit Map (Positive Logic)**

Failure Bit	Meaning if set to 1
0	Flow sensor failure.
1	Instrument failure. Note that while the In Maintenance mode reports as an instrument failure with a red light on the front panel, for Bayern-Hessen this particular error is merely a status instead of a failure.
2	-
3	Lamp failure (S40 family only).
4	-
5	Cell heater failure (S30, S40 and S50 family only).
6	-
7	-

### C.2.2 ST

Set the instrument mode.

#### Command Format

<STX>{ST}{< kkk>}<SP>{command}<ETC><bcc1><bcc2>

Where:

kkk                      Device’s Serial ID. This field is optional, but if provided it must be padded with zeros to be 3 characters long. The value must match one of the following: the instrument’s Bayern-Hessen ID, 000, or ??? (three question marks).

Command                M, N or K for Measure, Zero or Span mode.

bcc1                      First byte of the block check calculation.

bcc2                      Second byte of the block check calculation.

#### Device response

The device does not issue a response to this command.



## Appendix D. ModBus Protocol

The Serinus supports a limited Modbus implementation. The only function codes supported are 3 (read holding register) and 16 (write multiple registers). The Serial ID is assigned in the **Main Menu** → **Communications Menu** → **Serial Communication Menu**.

### D.1 Command Format

<Slave address><Function code><Start register (MSB)><Start register (LSB)><Register count (MSB)><Register count (LSB)><Write byte count><Write data><CRC (MSB)><CRC (LSB)>

Where:

Slave address	The instrument Serial ID. If the request is being made via TCP, this field is omitted.
Function code	3 (read) or 16 (write).
Start register	Specifies an Advanced Protocol IEEE index (refer to Table 19 to see what values are available and what index to specify for them). The Modbus index is calculated from the Advanced Protocol index via the following formula:  $\text{Modbus Index} = \text{Advanced Protocol Parameter List number} \times 2 + 256$
Register count	A single read command may request from 2 to 124 registers, which is to say from 1 to 62 values. The first index is specified by Start register; all following indexes are in sequential order. To read values that are not sequential requires using another read command. Note that the number of registers must be even, as each value is returned as a floating point value (4 bytes) and each register is a word (2 bytes).  A write command can only write a single IEEE value at a time. Thus for write commands this value must be 2.
Write byte count	This field is only supplied for a write request; it indicates the amount of bytes of data that will follow, and must be set to 4 (since only one value can be written at a time).
Write data	This field is only supplied for a write request. It is the value to be written, expressed in IEEE format. The “Endian” structure can be selected on the Modbus Serial Communications menu. Big Endian means that the MSB byte of the IEEE value is at the right end of the four bytes; Little Endian means it is at the left.
CRC	Calculated by the standard Modbus CRC method. If the request is being made via TCP, this field is omitted.

---

## D.2 Commands

---

### D.2.1 Read Holding Registers

The response to a read request is in the following format:

<Slave address>3<Register count (MSB)><Register count (LSB)><Data><CRC (MSB)><CRC (LSB)>

Where:

Slave address	As general command format.
Register count	As general command format.
Data	4 to 248 bytes of data, representing 1 to 62 floating point numbers in IEEE format. The “Endian” structure can be selected on the Modbus Serial Communications menu. Big Endian means that the MSB byte of the IEEE value is at the right end of the four bytes; Little Endian means it is at the left.
CRC	As general command format.

### D.2.2 Write Holding Register

The only supported use for this command is to set the instrument into a calibration state.

Where:

Start register MSB	1
Start register LSB	170
Register count	2
Write Data bytes	The IEEE representation of 0, 1, 2, or 3 0 puts the instrument into Measure mode (0,0,0,0) 1 puts the instrument into Cycle mode (63,128,0,0) 2 puts the instrument into Zero mode (64,0,0,0) 3 puts the instrument into Span mode (64,64,0,0)

The response to a write request is to return the first six bytes of the initiating write request.

### D.2.3 Error

An error will be returned in the following format:

<Slave address><Function code><Exception code><CRC (MSB)><CRC (LSB)>

---

Slave address	As general command format.
Function code	The initiating command's function code + 128; so either 131 (read) or 144 (write).
Exception code	The error code (see table below).
CRC	As general command format.

**Table 24 – Modbus Error Codes**

Value	Error
1	Illegal Function
2	Illegal Data Address
3	Illegal Data Value
4	Slave Device Failure



POWERED BY ACOEM

**metone.com**

User manual subject to change without notice. Images used are for illustrative purposes only.  
All trademarks and registered trademarks are the property of their respective owners.  
© 2022 Acoem and all related entities. All rights reserved.