

GARMIN®

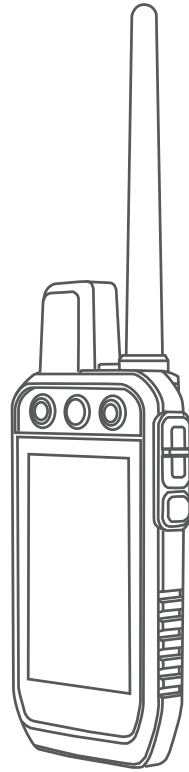

Alpha[®] 200 with Training

Owner's Manual

© 2020 Garmin Ltd. or its subsidiaries

All rights reserved. Under the copyright laws, this manual may not be copied, in whole or in part, without the written consent of Garmin. Garmin reserves the right to change or improve its products and to make changes in the content of this manual without obligation to notify any person or organization of such changes or improvements. Go to www.garmin.com for current updates and supplemental information concerning the use of this product.

Garmin®, the Garmin logo, Alpha®, ANT®, ANT+®, City Navigator®, and Xero® are trademarks of Garmin Ltd. or its subsidiaries, registered in the USA and other countries. BaseCamp™, Garmin Explore™, Garmin Express™, Garmin HuntView™, tempe™, and TT™ are trademarks of Garmin Ltd. or its subsidiaries. These trademarks may not be used without the express permission of Garmin.

Apple® and Mac® are trademarks of Apple Inc., registered in the U.S. and other countries. The BLUETOOTH® word mark and logos are owned by the Bluetooth SIG, Inc. and any use of such marks by Garmin is under license. microSD® and the microSDHC logo are trademarks of SD-3C, LLC. Wi-Fi® is a registered mark of Wi-Fi Alliance Corporation. Windows® is a registered trademark of Microsoft Corporation in the United States and other countries. Other trademarks and trade names are those of their respective owners.

Table of Contents

Getting Started	1	Changing the Length of the Dog's Track.....	13
Setting Up the Alpha System.....	1	Location Alerts.....	13
Device Overviews.....	2	Setting Location Alerts.....	14
Alpha Handheld Device.....	2	Editing Location Alerts.....	14
Dog Collar Device.....	4	Disabling Dog Data Broadcast.....	14
Installing the Battery Pack.....	5	Dog Training	14
Charging the Handheld Device.....	5	Selecting and Installing the Contact Points.....	15
Charging the Dog Collar Device.....	6	Removing the Contact Points.....	15
Turning On the Device.....	6	Training Methods.....	15
Turning Off the Device.....	6	Linear and Traditional Stimulation..	15
Selecting a Language.....	6	Choosing the Correct Intensity Level.....	15
Using the Touchscreen.....	6	Customizing the Training Keys.....	16
Using the Status Page.....	7	Using the Hard Keys for Training Adjustments.....	16
Acquiring Satellite Signals.....	7	Default Training Settings.....	16
Dog Collar Device Setup	7	Collar Training.....	17
Methods to Add a Dog Collar Device to a Handheld Device.....	7	Connected Features	17
Adding a Dog to the Alpha Handheld Using Wireless Pairing.....	8	Pairing a Smartphone with Your Device.....	17
Sharing a Dog Wirelessly.....	8	Connecting to a Wireless Network.....	17
Adding a Dog Using the Track and Control Codes.....	8	Garmin Explore.....	18
VHF Radio Information.....	9	Contact Tracking	18
Managing a Group.....	9	Turning On and Off the Transmitter....	18
Editing Dog Information.....	9	Methods to Add a Contact to a Handheld Device.....	18
Resetting a Dog's Statistics and Track.....	9	Adding a Contact Using Wireless Pairing.....	18
Changing the Dog Name.....	9	Adding a Contact Using a Contact ID..	19
Changing the Color of the Dog's Track.....	9	Initiating an Emergency Alert.....	19
Changing the Dog Type.....	9	Sending a Message to Your Contacts.....	19
Changing the Dog ID.....	10	Tracking a Contact.....	19
Removing a Dog.....	10	Finding Your Contact ID.....	19
Fitting the Collar on Your Dog.....	10	Changing Your Contact ID.....	19
Communication with the Collar.....	11	Updating a Contact ID.....	20
Entering Sleep Mode.....	11	Hunting with the Alpha System	20
Exiting Sleep Mode.....	11	Marking Your Truck Location.....	20
Dog Tracking	11	Marking a Covey.....	20
Tracking Your Dog on the Map.....	12	Active Hunt Metrics.....	20
Dog Status Icons.....	12	Turning On the Collar Light.....	20
Dog Tracking Compass.....	13		
Navigating to Your Dog.....	13		

Turning On Rescue Mode.....	21	Calibrating the Barometric	
Pausing Dog Tracking.....	21	Altimeter	26
Waypoints, Routes, and Tracks.....	21	Navigating to a Point on the Plot.....	26
Waypoints.....	21	Changing the Plot Type.....	26
Marking Your Current Location.....	21	Resetting the Elevation Plot.....	26
Marking a Waypoint Using the		Trip Computer.....	26
Map.....	21	Customizing the Trip Computer Data	
Editing a Waypoint.....	21	Fields.....	26
Repositioning a Waypoint to Your		Resetting the Trip Computer.....	26
Current Location.....	22	Applications.....	27
Moving a Waypoint on the Map.....	22	Setting a Proximity Alarm.....	27
Increasing the Accuracy of a Waypoint		Calculating the Size of an Area.....	27
Location.....	22	Setting an Alarm.....	27
Projecting a Waypoint.....	22	Using the Competition Timer.....	27
Deleting a Waypoint.....	22	Satellite Page.....	27
Routes.....	22	Changing the Satellite View.....	27
Creating a Route.....	23	Turning Off GPS.....	27
Editing the Name of a Route.....	23	Simulating a Location.....	28
Navigating a Saved Route.....	23	Downloading BirdsEye Imagery.....	28
Editing a Route.....	23	Customizing Your Device.....	28
Reversing a Route.....	23	Customizing the Main Menu.....	28
Viewing the Active Route.....	23	Customizing the Data Fields.....	28
Deleting a Route.....	23	System Settings.....	29
Recordings.....	23	Display Settings.....	29
Recording Track Logs.....	24	Accessibility Settings.....	29
Viewing Details about the Track.....	24	Setting the Device Tones.....	29
Viewing the Elevation Plot of a		Setting Dog Alerts.....	29
Track.....	24	Map Settings.....	29
Navigating to the Start of a Track....	24	Tracked Devices Map Settings.....	30
Changing the Track Color.....	24	Advanced Map Settings.....	30
Saving the Current Track.....	24	Tracks Settings.....	30
Clearing the Current Track.....	24	Auto Save Settings.....	30
Deleting a Track.....	24	Routing Settings.....	31
Navigation.....	25	Sensors Settings.....	31
Map.....	25	Changing the Units of Measure.....	31
Measuring Distance on the Map.....	25	Position Format Settings.....	31
Compass.....	25	Device Information.....	31
Calibrating the Compass.....	25	Viewing E-label Regulatory and	
Navigating with the Bearing		Compliance Information.....	31
Pointer.....	25	Support and Updates.....	32
Where To? Menu.....	25	Product Updates.....	32
Finding a Waypoint by Name.....	25	Device Care.....	32
Navigating with Sight 'N Go.....	26	Cleaning the Device.....	32
Elevation Plot.....	26	Cleaning the Touchscreen.....	32

Specifications	33
Alpha Handheld Device	
Specifications	33
Dog Collar Device Specifications	33
Mini Dog Collar Device	
Specifications	33
Battery Information	34
Long-Term Storage	34
Maximizing the Battery Life	34
Saving Energy While Charging the	
Device	35
Data Management	35
Installing a Memory Card	36
Connecting the Handheld Device to a	
Computer	36
Connecting the Collar to a	
Computer	37
Transferring Dog Tracks to	
BaseCamp™	37
Deleting Files	37
Disconnecting the USB Cable	37
Resetting Data and Settings	37

Appendix 38

Accessories and Replacement Parts..	38
Purchasing Accessories	38
tempe	38
Tips for Pairing ANT+ Accessories	
with Your Garmin Device	38
Dog Collar Device Battery	
Replacement Instructions	39
Replacing the Mini Dog Collar Device	
Battery	41
Replacing the Collar Strap	41
Replacing the VHF Antenna in the Dog	
Collar Device	42
Changing the Fuse in the Vehicle	
Power Cable	43
Data Field Options	44

Index 47

Getting Started

WARNING

See the *Important Safety and Product Information* guide in the product box for product warnings and other important information.

Setting Up the Alpha System

Before you can use the Alpha system, you must set up the devices.

- 1 Charge the handheld device (*Charging the Handheld Device, page 5*).
- 2 Charge the dog collar device (*Charging the Dog Collar Device, page 6*).
- 3 Turn on the devices (*Turning On the Device, page 6*).
- 4 Select a language (*Selecting a Language, page 6*).
- 5 If necessary, pair the dog collar device with the handheld device (*Methods to Add a Dog Collar Device to a Handheld Device, page 7*).
- 6 If necessary, calibrate the compass on the handheld device (*Calibrating the Compass, page 25*).

Device Overviews

Alpha Handheld Device

NOTICE

Avoid using a high-powered radio (greater than 5 W) in close proximity to the handheld device. It may cause irreversible damage to the handheld device.



①	Satellite antenna
②	VHF radio antenna
③	Mounting spine
④	microSD® memory card slot (under battery)
⑤	Battery cover D-ring
⑥	Micro-USB port (under weather cap)

Alpha Device Keys



①	Power key
②	Customizable training keys
③	Training up
④	Training down
⑤	Training enter

Dog Collar Device

NOTE: Your dog collar device may look different than the device pictured.

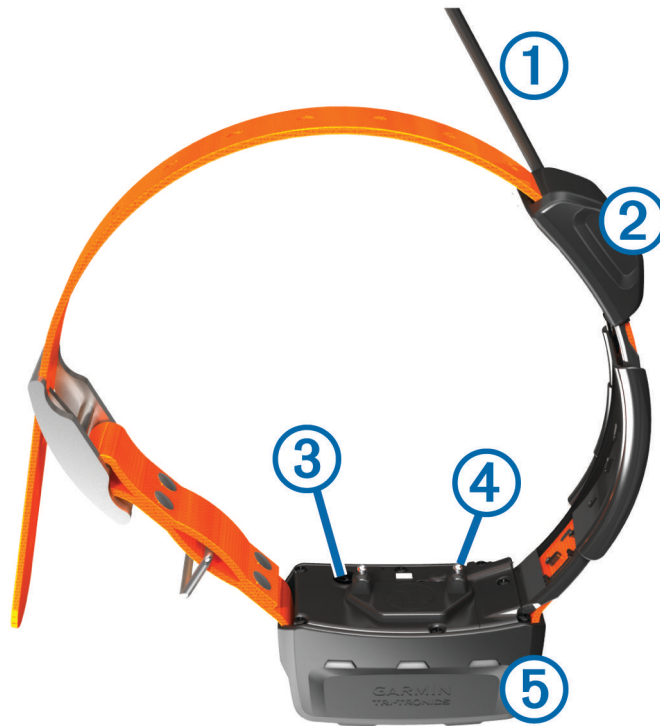

①	VHF antenna
②	GPS antenna
③	Power key
④	Contact points
⑤	Status LED and flashing beacon LEDs

Installing the Battery Pack

- 1 Turn the D-ring counter-clockwise, and pull up to remove the cover.
- 2 Locate the metal contacts on the end of the lithium-ion battery.
- 3 Insert the battery into the compartment, contacts first.



- 4 Press the battery into place.
- 5 Replace the battery cover, and turn the D-ring clockwise.

Charging the Handheld Device

NOTICE

To prevent corrosion, thoroughly dry the USB port, the weather cap, and the surrounding area before charging or connecting to a computer.

NOTE: The device does not charge when it is outside the approved temperature range (*Alpha Handheld Device Specifications*, page 33).

You should fully charge the battery before you use the device for the first time. Charging a fully depleted battery takes about 4 hours.

- 1 Lift the weather cap ①.



- 2 Plug the small end of the power cable into the USB port ② on the device.
 - 3 Plug the other end of the power cable into an appropriate power source.
- The LCD display on the handheld device shows the current battery charge level.

Charging the Dog Collar Device

NOTICE

To prevent corrosion, thoroughly dry the contacts on the collar and the surrounding area before connecting the charging clip.

NOTE: Your dog collar device may look different than the device pictured.

You should fully charge the battery before you use the device for the first time. Charging a fully depleted battery takes about five hours.

- 1 Snap the charging clip ① onto the device ②.

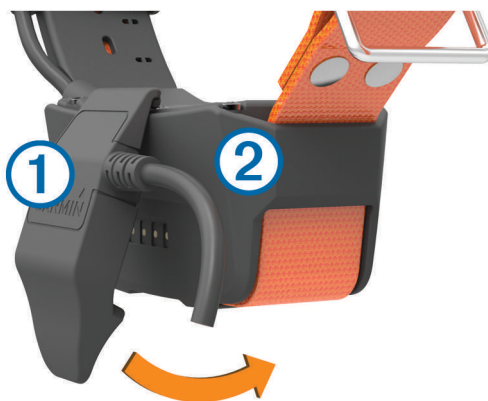

- 2 Plug the small end of the power cable into the mini-USB port on the charging clip cable.
- 3 Plug the power cable into a power source.
The status LED is solid red when the collar is charging.
- 4 After the status LED turns solid green, remove the charging clip from the collar.

Turning On the Device

- On the handheld device, press the power key.
- On the dog collar device, hold the power key until the status LED flashes and the collar beeps.

Turning Off the Device







- On the handheld device, hold the power key until the LCD screen turns off.
- On the dog collar device, hold the power key until the status LED turns red.

Selecting a Language

When you turn on your device for the first time, you will select the device language from a list of available languages. You can change the language setting from the System settings.

- 1 From the main menu, select **Setup > System > Language**.
- 2 Select a language.

Using the Touchscreen

- Select  to open a menu.
- Select  to return to the home screen.
- Select  to return to the previous page.
- If you are more than one menu away from the home screen, select and hold  to return to the home screen.
- If scroll controls are enabled, select  and  to scroll ([Accessibility Settings, page 29](#)).

Using the Status Page

The status page displays the time, your GPS signal strength, and the device battery life. It also allows you to adjust settings and access shortcuts. You can open the status page from any other page by pressing the power key.

Screen brightness: Adjusts the brightness of the screen.

Lock Screen: Locks the touchscreen to prevent inadvertent screen touches.

Lock Keys: Locks the device keys to prevent inadvertent key presses.

My ID: Displays your device ID and allows you to transmit your device information to a compatible handheld device. You can also turn the transmitter on and off.

Alerts: Displays unread dog alerts.

Acquiring Satellite Signals

Both the collar and handheld device must acquire satellite signals before you put the collar on your dog. Acquiring satellites can take a few minutes.

- 1 Go outdoors to an open area.
- 2 Turn on both devices ([Turning On the Device, page 6](#)).
 in the status bar shows the GPS signal strength.

When the collar has acquired satellite signals, the status LED flashes a double-blink or triple-blink in green.

Dog Collar Device Setup

Methods to Add a Dog Collar Device to a Handheld Device

You can add up to 100 devices to one handheld device by using MURS/VHF, entering the track and control codes, or by sharing wirelessly using ANT+® technology. Up to 20 devices can be active at one time.

Using MURS/VHF: Allows you to add a dog collar device after you have placed the dog collar device into pairing mode by pressing the power key.

This method is helpful when you are adding a new accessory collar to the system prior to leaving for the hunt ([Adding a Dog to the Alpha Handheld Using Wireless Pairing, page 8](#)).

Entering the track and control codes: Allows you to add a dog collar device that you do not own and that is not in the area. The dog's owner must determine if you can only track the dog or can track and control the dog. This method requires the dog's owner to find and communicate the codes to the person adding the dog collar device.

This method is helpful when you would like to add a dog collar device during a hunt, but you are not near the dog. For example, you are adding another member of your hunting party's dog collar device to your handheld device, but you do not own the dog collar device ([Adding a Dog Using the Track and Control Codes, page 8](#)).

NOTE: This feature varies based on dog collar device type and feature availability in your area. You may see track codes only or track and control codes.

Sharing wirelessly using ANT+ wireless technology: Allows you to add a dog collar device that you do not own and that is not in the area. The dog's owner must determine if you can only track the dog or can track and train the dog. This method does not require the dog's owner to find and communicate the codes to the person adding the dog collar device. This method also adds dog information, such as the dog's name, communication settings, and initial position, from the sending handheld device to your device. The two handheld devices must be within range 3 m (10 ft.) to share data wirelessly.

This method is helpful when you want to add a dog collar device during a hunt, but you are not near the dog. For example, the dogs have already been let loose, and you are near the dog owner, who can share the dog wirelessly ([Sharing a Dog Wirelessly, page 8](#)).

Adding a Dog to the Alpha Handheld Using Wireless Pairing

- 1 If the dog collar device is on, turn off the dog collar device (*Turning Off the Device, page 6*).
- 2 Hold the power key on the dog collar device until the device emits two series of beeps (about 2 seconds), and then release the power button.
The status LED flashes rapidly in green. The dog collar device is now ready to be linked, or paired, with a handheld device.
- 3 On the handheld device, select **Dog List > Add Dog**.
- 4 Select an option:
 - If you are near the dog collar device, select **Pair Collar**, and follow the on-screen instructions.
 - To pair a dog collar device by receiving the information from another handheld device, select **Receive from Handheld**.
NOTE: To successfully pair the device, the other handheld device must be wirelessly sharing the dog collar device information (*Sharing a Dog Wirelessly, page 8*).
- 5 After successfully adding the dog collar device, enter the name of the dog, and select ✓.

Sharing a Dog Wirelessly

Before you can share data wirelessly over ANT+, you must bring your Alpha handheld device within 3 m (10 ft.) of the other handheld device.

- 1 Select **Dog List**.
- 2 Select the dog to share.
- 3 Select  > **Share Wirelessly**.
- 4 Select an option:
 - To allow the other person to track your dog's location with the map and dog tracking compass, select **Track Only**.
 - To allow the other person to track your dog and correct your dog's behavior, select **Track and Train**.To successfully share the dog collar device, the other handheld device must be receiving the device information (*Adding a Dog to the Alpha Handheld Using Wireless Pairing, page 8*).

Adding a Dog Using the Track and Control Codes

NOTE: This feature varies based on dog collar device type and feature availability in your area.

Before you can add a dog using the track and control codes, the dog owner must find the track and control codes (*Finding the Dog ID and Track and Control Codes, page 8*) and tell them to you.

You can use track and control codes to authorize a handheld device to interact with your dog collar device. If you are not near the dog you want to add or you cannot put the collar into pairing mode, you can add the dog using the track and control codes.

- 1 Select **Dog List > Add Dog**.
- 2 Select **Enter Track or Control Code**.
- 3 Enter the track or control code for the collar, and select ✓.
The dog's track code allows you to track the dog. The dog's control code allows you to both track and train the dog.
- 4 Enter the name of the dog, and select ✓.

Finding the Dog ID and Track and Control Codes

You can share a dog's track code so another person can track your dog. Also, you can share a dog's control code so another person can track and train your dog.

- 1 Select **Dog List**.
- 2 Select a dog.
The track code and the control code are displayed under the dog's name.

VHF Radio Information

This product may be used only on specific radio frequencies, which vary depending on the country of use. The handheld device and the dog device allow the user to install a different antenna. Changing the antenna can result in improved radio performance and higher radiated power. You must not use the device with a third party antenna or an antenna not approved by Garmin®. Go to www.garmin.com/tracking-legal for details about the performance and radio frequency of this product, lawful accessories, and power limits for countries.

Managing a Group

Before you can create a group, you must pair one or more dog devices to your handheld.

- 1 Select **Dog List**.
- 2 Select .
- 3 If necessary, select **Create Group**, and enter a group name.
- 4 Select a group from the list.
- 5 Select an option:
 - To activate the group, select **Activate Group**.
 - To deactivate the group, select **Deactivate Group**.
 - To add a device to the group, select **Manage Group > Add Device**.
 - To rename the group, select **Rename**, and enter a new name.
 - To delete the group, select **Delete Group**.

Editing Dog Information

Resetting a Dog's Statistics and Track

You might want to clear the dog statistics and track before a new hunt.

- 1 Select **Dog List**.
- 2 Select a dog.
- 3 Select  > **Reset**.

Changing the Dog Name

- 1 Select **Dog List**.
- 2 Select a dog.
- 3 Select the dog's name.
- 4 Enter the name, and select .

Changing the Color of the Dog's Track

You can change the track color of the dog. It is helpful to have the track color match the color of the collar strap, if possible.

- 1 Select **Dog List**.
- 2 Select a dog.
- 3 Select the colored square next to the dog's name.
- 4 Select a color.

Changing the Dog Type

Before you can change the dog type, the collar must be turned on and within range of the handheld device.

- 1 Select **Dog List**.
- 2 Select a dog.
- 3 Select  > **Change Dog Type**.
- 4 Select a dog type.

Changing the Dog ID

Before you can change the dog ID, the collar must be turned on and within range of the handheld device.

If you are experiencing interference from other collars or handheld devices in the area, you might need to change the ID for the dog.

- 1 Select **Dog List**.
- 2 Select a dog.
- 3 Select  > **Change ID**.
- 4 Select an available ID.

If another handheld device is tracking this dog, for best results, remove the dog from the device, and use the track and control codes to add the dog again ([Adding a Dog Using the Track and Control Codes, page 8](#)).

Removing a Dog

- 1 Select **Dog List**.
- 2 Select a dog.
- 3 Select  > **Remove**.

Fitting the Collar on Your Dog

CAUTION

To prevent irritation from the contact points, remove the collar for at least eight hours out of every 24-hour period.

This device is not intended for human use. Do not attempt to use on any person.

Do not spray the device or collar with harsh chemicals including but not limited to flea or tick spray. Always ensure that any flea or tick spray that is applied to the dog is completely dry before placing the collar on the dog. Small amounts of harsh chemicals can damage the plastic components and collar laminate.

In order to effectively train the dog, the collar and device must fit the dog properly. If the collar is too loose or positioned incorrectly, stimulation may be inconsistent. This can delay or prevent successful training.

- 1 Position the device at the front of the dog's neck, with the status LED facing toward the dog's chin and the contact points against the throat.
- 2 Tighten the strap so that it is very snug around the dog's neck, and fasten the buckle.

NOTE: The collar should fit tightly and should not be able to rotate or slide on the dog's neck. The dog must be able to swallow food and water normally. You should observe your dog's behavior to verify that the collar is not too tight.

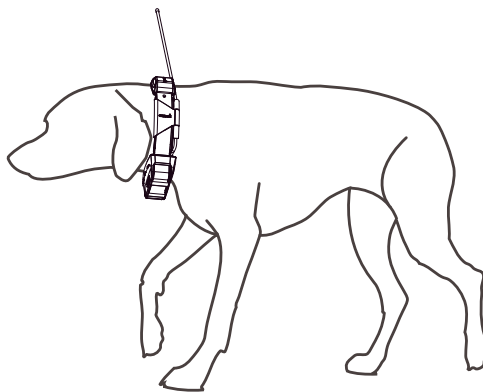

- 3 Wiggle the device to work the contact points through the dog's coat.
NOTE: The contact points must have contact with the dog's skin to be effective.
- 4 If the strap is too long, cut off the excess, leaving at least 8 cm (3 in.) to spare.
TIP: You can mark the hole used to fasten the buckle for future reference.

Communication with the Collar

You should keep an unobstructed line of sight between your handheld device and the dog collar device to produce the best communication signal. To achieve the best line-of-sight conditions, you should move to the highest elevation point in your area (for example, on the top of a hill).

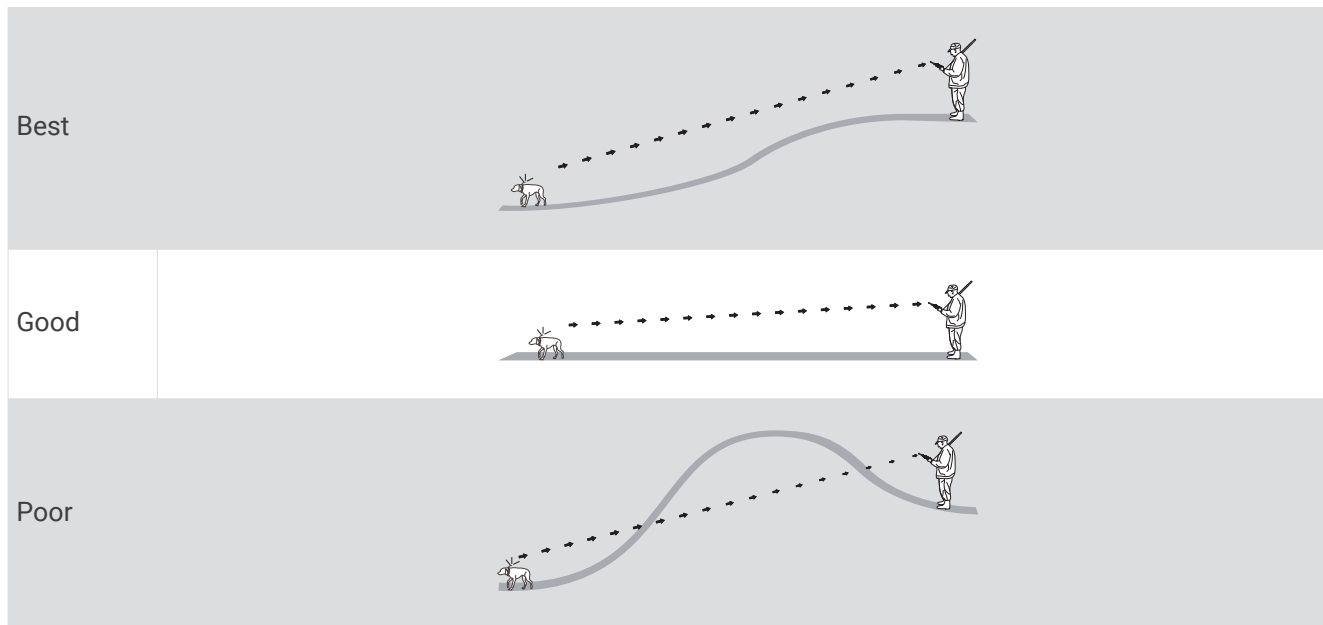

Entering Sleep Mode

NOTE: This feature is not available with all dog collar device models.

Before you can enter sleep mode, you must track your dog's location using the compatible dog collar device. When connected with the handheld device, the dog collar device can be put into sleep mode to conserve the battery when you are not actively tracking your dog.

- 1 Select **Dog List**.
- 2 Select a dog.
- 3 Select  > **Adjust Collar Sleep Mode** > **Sleep**.

Exiting Sleep Mode

NOTE: This feature is not available with all dog collar device models.

You can exit sleep mode on the compatible dog collar device while you are not actively tracking your dog.

- 1 Select **Dog List**.
- 2 Select a dog.
- 3 Select  > **Adjust Collar Sleep Mode** > **Wake**.

Dog Tracking

The handheld device allows you to track your dog or multiple dogs, using the tracking compass or map. The map displays your location and your dog's location and tracks. The compass pointer indicates the direction of the dog's current location.

Tracking Your Dog on the Map

Before you can track a dog on the map, you must add it to the handheld device ([Adding a Dog to the Alpha Handheld Using Wireless Pairing, page 8](#)).

You can view the dog's location on the map.





1 From the home screen, select .



2 If necessary, select  and  to zoom in and out of the map.

TIP: You can select  to track the dog using the dog tracking compass ([Dog Tracking Compass, page 13](#)).

Dog Status Icons

	Sitting
	Running
	On point
	Treed
	Unknown ¹

¹ The unknown status icon indicates that the collar has not acquired a satellite signal and that the handheld device cannot determine the location of the dog.

Dog Tracking Compass

To open the dog tracking compass, select .

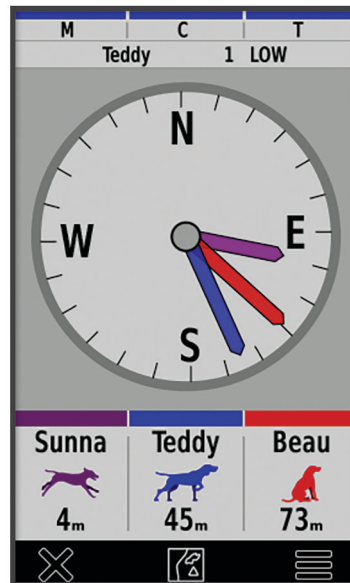

You can use the dog tracking compass to view the direction and distance to your dog, your vehicle, and any paired devices. The dog tracking compass also shows the dog's status, such as running or on point ([Dog Status Icons](#), page 12). The color of the pointer corresponds to the color of the track.

The dog tracking compass is most accurate when the dog, vehicle, or paired device is more than 9.1 m (30 ft.) away. When the dog, vehicle, or paired device is less than 9.1 m (30 ft.) away, "Near" appears.

TIP: You can open an alternative view of the compass by selecting  > **Pro View**.

Navigating to Your Dog

- 1 Select **Dog List**.
- 2 Select the dog.
- 3 Select  > **Go**.
- 4 Follow the colored line to the dog.

Changing the Length of the Dog's Track

You can adjust the length of time the dog track appears on the map. Reducing the duration of the track can reduce the clutter on the map. Changing the map does not affect the tracks stored in the handheld device.

- 1 Select **Setup > Map > Tracked Devices > Dog Tracks on Map**.
- 2 Select a time frame.

Location Alerts

Location alerts notify you when your dogs enter or exit a particular location. You can create a custom geofence or use a radius around your current location.

A geofence is an invisible boundary around an area and is created using points on the map. The virtual boundaries of a geofence are accurate up to approximately 3 m (10 ft.). Geofences perform best when sized to cover an area encompassing an average sized backyard (approximately $\frac{1}{4}$ acre).

Setting Location Alerts

- 1 Select **Location Alerts > Add Alert**.
- 2 Select an option:
 - To create a geofence alert, select **Geofence**, select a point for the first corner of the geofence, select **Use**, and select additional points to define the geofence boundary.
You must select at least 3 points to create a geofence alert.
 - To create a radius alert, select **Radius**, select the unit of measurement, and enter the radius distance.

Editing Location Alerts

- 1 Select **Location Alerts**.
- 2 Select an alert.
- 3 Select an option:
 - Select **Disable** to turn off notifications for this alert.
 - Select **Set Alert Type** to set the way the device notifies you for this alert.
 - Select **Set Alert Mode** to set the notification to sound on exit, entrance, or both.
 - Select **View Map** to view a geofence on the map.
NOTE: This feature is not available for the radius alert type.
 - Select **Delete** to remove the alert.

Disabling Dog Data Broadcast

By default, the handheld device broadcasts dog data to compatible devices. You can disable data broadcasting to keep your data from being seen on other compatible devices. See the owner's manual for your compatible device for more information.

Select **Setup > System > Broadcast Dog Data > Off**.

Dog Training

NOTICE

You should research and investigate the training methods best suited for you, your dog, and your needs. This manual provides some basic guidelines for training, but each dog has unique training needs.

When used properly, the Alpha training system is a very effective training tool to aid your dog in reaching its full potential. The use of the training system should be part of an overall training program.

Begin training your dog on a leash, without the Alpha training system. You should train your dog how to heel, sit, and come to you. After the dog understands these three basic commands, you can begin training with the dog collar device and the leash. Finally, when the dog consistently obeys commands using the leash and collar, you may be able to remove the leash to train with only the dog collar device.

Selecting and Installing the Contact Points

⚠ CAUTION

To prevent irritation from the contact points, remove the collar for at least eight hours out of every 24-hour period.

Do not spray the device or collar with harsh chemicals including but not limited to flea or tick spray. Always ensure that any flea or tick spray that is applied to the dog is completely dry before placing the collar on the dog. Small amounts of harsh chemicals can damage the plastic components and collar laminate.

For best results, select the correct contact points based on your dog's coat.

- 1 Select the correct contact point length for your dog's coat type:
 - For dogs with thicker coats, use the longer contact points.
 - For dogs with shorter coats, use the shorter contact points.
- 2 If necessary, use the included wrench to remove the contact points.
- 3 Twist the contact points into the collar.
- 4 Tighten with the included wrench, but do not overtighten.

When you put the collar on the dog, make sure the contact points are tight against the neck.

Removing the Contact Points

When you are not training the dog using the training keys, remove the contact points.

- 1 Use the included wrench to remove both contact points.
- 2 Place the cap over the contact point holes.

Training Methods

NOTE: Training features are not available in all areas for tracking collars.

Momentary stimulation: Applies a brief stimulation when you press the training key, regardless of how long the key is depressed.

Continuous stimulation: Applies stimulation to the dog the entire time you press the training key, for a maximum of 8 seconds. Your stimulations should typically be much shorter than 8 seconds.

Tone: Activates an audible tone the entire time you press the training key.

Vibration: Applies vibration to the dog the entire time you press the training key, for a maximum of 8 seconds. The effectiveness of vibration may vary based on the dog's temperament and experience.

Linear and Traditional Stimulation

You can use linear or traditional stimulation to customize your training experience. The default intensity method is linear, which allows progressive stimulation from level 1 to level 18. Traditional stimulation allows you to make quick changes using low, medium, and high settings within predetermined stimulation levels (1 through 6).

Choosing the Correct Intensity Level

- 1 Set the intensity to the lowest level (*Customizing the Training Keys, page 16*).
- 2 Select a training key.
- 3 Observe the dog for a reaction, such as a head shake, neck movement, or just a change in expression. Sometimes dogs will vocalize due to the surprise of the electrical stimulation. If the dog vocalizes more than once, the intensity level is too high for beginning training.
- 4 If there is no reaction, increase the intensity level by one level until the dog has a slight but recognizable reaction to the stimulation.

The intensity level that causes a slight but recognizable reaction is your dog's baseline level for beginning collar training. You do not need to, and should not, apply this intensity selection test again.

After you begin training, the dog's performance guides your intensity selection. As the dog advances in training, you may need to change the level depending upon the training situation.

Customizing the Training Keys

You can assign an application, device action, or utility to a training key. If a compatible dog collar is paired, you can also add a dog training command to a training key. You can add multiple pages of training key settings. For example, this is useful when training multiple dogs.

- 1 Select **Training Setup > Training Keys**.
- 2 Select **Add Item Here** below the empty key you are customizing.
- 3 Select a command category.
- 4 Select a command or, if selecting a training command, select the name of the dog to command.
- 5 If selecting a dog training command, select momentary (**M**), continuous (**C**), tone (**T**), vibration (**V**), or light (**L**).
- 6 Select **—** or **+** to choose the intensity level.
- 7 If you are using traditional stimulation mode, select **LOW, MED, or HI**.
- 8 If you want to customize more than three keys, use the additional rows to add another page of training key commands.

Using the Hard Keys for Training Adjustments

Before you can use this feature, you must customize your training keys with dog training commands ([Customizing the Training Keys, page 16](#)).

You can access and adjust training commands using the device's hard keys.

- 1 From any screen, press the training up and down keys until the command page you want to adjust appears.
- 2 Press the training enter key to select the command page.
- 3 Use the training up and training down keys to highlight the training command you want to change, and press the training enter key.
- 4 Select the command mode, and press the training enter key.
- 5 If necessary, use the training up and down keys to adjust the command setting.
- 6 Press the training enter key to return to the previous screen.

Default Training Settings

From the main menu, select **Training Setup > Training Defaults**.

Add When Paired: Automatically sets default training modes for each button when a new dog collar is paired.

Left Button: Sets the default training mode for the left training button.

Center Button: Sets the default training mode for the center training button.

Right Button: Sets the default training mode for the right training button.

Collar Training

Begin training your dog on a leash, without using the Alpha training system. After the dog shows a grasp of the commands "heel," "sit," and "here," you can begin training with the collar and the leash.

During the initial stage of collar introduction, the dog learns that collar stimulation means the same thing as a tug on the leash. At first, the dog may be alarmed by the electronic stimulation. The key is to be patient and consistent and not to start off at too high of an intensity. Be fair and consistent, and use repetition and praise when using the collar as a training tool.

If the dog does not respond to the stimulation level you have selected (*Choosing the Correct Intensity Level*, page 15), increase the stimulation one level at a time until you achieve the appropriate response. After you achieve the desired response, you can lower the stimulation level as long as the dog maintains consistency.

As the dog becomes more proficient with the commands, you can begin to introduce distractions, such as rolling a ball in front of the dog or walking him in the presence of others.

After the dog begins to respond consistently to the command during collar training, you can remove the leash and train with just the collar.

NOTE: You should train without a leash only when it is appropriate for your environment and your dog's temperament. You should follow all laws and regulations for your area regarding the use of dog leashes.

Eventually in most training situations, your commands will not require stimulation to be given with the command. You should only use stimulation when you need to repeat a command because the dog did not obey the first one.

As the dog becomes better trained, you can decrease the use of collar training. Continue to have the dog wear the collar until you feel certain that it is no longer needed to reinforce known commands. Abandoning the collar too early can lead to problems in the future.

Connected Features

Connected features are available for your Alpha device when you connect the device to a wireless network or a compatible smartphone using Bluetooth® technology. Some features require you to install the Garmin Explore™ app on your smartphone. Go to garmin.com/apps for more information.

BirdsEye imagery: Allows you to download BirdsEye Satellite Imagery directly to your device when connected to a Wi-Fi® network.

Garmin Explore: The Garmin Explore app syncs and shares waypoints, tracks, and routes with your device. You can also download maps to your smartphone for offline access.

Software Updates: Allows you to receive updates for your device software when connected to a Wi-Fi network.

Pairing a Smartphone with Your Device

- 1 Bring your compatible smartphone within 10 m (33 ft.) of your device.
- 2 From the main menu on your device, select **Setup > Bluetooth**.
- 3 On your compatible smartphone, enable Bluetooth technology, and open the Garmin Explore app.
- 4 From the Garmin Explore app, select **Devices > Pair Device**.
- 5 Follow the on-screen instructions in the Garmin Explore app to pair your device.

Connecting to a Wireless Network

- 1 Select **Setup > Wi-Fi**.
- 2 Select the toggle switch to enable Wi-Fi technology, if necessary.
- 3 Select **Add Network**.
- 4 Select a wireless network from the list and enter the password, if necessary.

The device stores the network information and connects automatically when you return to this location.

Garmin Explore

The Garmin Explore website and mobile app allow you to plan trips and use cloud storage for your waypoints, routes, and tracks. They offer advanced planning both online and offline, allowing you to share and sync data with your compatible Garmin device. You can use the mobile app to download maps for offline access, and then navigate anywhere without using your cellular service.

You can download the Garmin Explore app from the app store on your smartphone, or you can go to explore.garmin.com.

Contact Tracking

You can track other hunters so you know where they are at all times. You can also send messages to your contacts. One Alpha handheld device can track up to 20 devices, including compatible dog collar devices and Alpha handheld devices.

Turning On and Off the Transmitter

Before you can add a contact or initiate an emergency alert, you must ensure the transmitter is enabled.

NOTE: In cold temperatures, if you transmit when the battery is low, the device may shut down.

- 1 Press  to open the status page.
- 2 Select **My ID > Transmitting**.

Methods to Add a Contact to a Handheld Device

Using MURS/VHF: Allows you to add a handheld device contact after you have placed your handheld device into pairing mode.

This method is helpful when you are adding a new device to the system prior to leaving for the hunt ([Adding a Contact Using Wireless Pairing, page 18](#)).

Entering the device ID: Allows you to add a handheld device contact that is not in the area. This method requires the contact to find and communicate their handheld device code to the person adding the device contact.



This method is helpful when you would like to add a handheld device contact during a hunt, but you are not near the device. For example, if you are adding another member of your hunting party to your handheld device, but you do not own the device ([Adding a Contact Using a Contact ID, page 19](#)).

Sharing wirelessly using ANT+ wireless technology: Allows you to add a handheld device that you do not own as a contact. This method does not require the contact to find and communicate their device code to the person adding the device. The two handheld devices must be within a range of 3 m (10 ft.) to share data wirelessly.

This method is helpful when you want to add a handheld device during a hunt without entering the device ID ([Adding a Contact Using Wireless Pairing, page 18](#)).

Adding a Contact Using Wireless Pairing

Before you can add a contact wirelessly, you should be near the contact's handheld device.

- 1 Select **Dog List >** .
- 2 Select an option:
 - On your handheld device select **Add > Pair Handheld**, and follow the on-screen instructions.
 - To add a contact by receiving the information from the contact's handheld device, select **Add > Receive from Handheld**.
- 3 After successfully adding the contact, enter the name of the contact, and select .



The contact is added to your handheld device.

You can repeat this procedure using another hunter's handheld device to add your contact ID to that device.

Adding a Contact Using a Contact ID

Before you can add a hunter using a contact ID, the hunter must find the contact ID ([Finding Your Contact ID, page 19](#)) and send it to you.

If you are not near the hunter you want to add, you can add the hunter using a contact ID.

- 1 On your handheld device, select **Dog List** >  > **Add** > **Enter ID**.
- 2 Select the contact ID for the contact you are adding.
- 3 Enter the name of the contact, and select .

The contact is added to your handheld device.

You can repeat this procedure using another hunter's handheld device to add your contact ID to that device.

Initiating an Emergency Alert

Before you can initiate an emergency alert, you must turn on the transmitter ([Turning On and Off the Transmitter, page 18](#)).

Before someone can receive your emergency alert, someone must add you as a contact ([Adding a Contact Using Wireless Pairing, page 18](#)).

You can use an emergency alert when you need immediate assistance and you are away from your group.

Select **Dog List** >  >  > **Yes**.

When your contact accepts your emergency alert request, the device displays a message indicating that your contact has started navigating to your location.

After receiving the alert, your contacts can navigate to your location.

Sending a Message to Your Contacts

Before you can send a message to your contacts, you must turn on the transmitter ([Turning On and Off the Transmitter, page 18](#)).

You can send and receive automated messages. There are 18 messages you can choose from, such as "Help" and "I'm Coming."

- 1 Select **Dog List** >  > **Message**.
- 2 Select a message.

The message is sent to your contacts with your name before the message. Anyone tracking your handheld device receives the message.

Tracking a Contact

You can keep track of contacts' locations using the map.

Select .

Finding Your Contact ID

Press  to open the status page.

The contact ID for your handheld device is listed under the My ID option.

Changing Your Contact ID



If you are experiencing interference from other collars or handheld devices in the area, you might need to change the contact ID for your handheld device.

- 1 Press  to open the status page.
- 2 Select **My ID** > **ID**.
- 3 Select a contact ID that is not yet assigned to another device in the area.

Each time a contact changes their contact ID, you must update the contact ID in your handheld device ([Updating a Contact ID, page 20](#)).

Updating a Contact ID

If a contact has changed their contact ID, you can quickly update the contact ID in your handheld device.

- 1 Select **Dog List** > .
- 2 Select the contact.
- 3 Select  > **Update ID**.
- 4 Select the contact ID that matches the contact's new contact ID.

Hunting with the Alpha System

You can perform various tasks that can be helpful when you are hunting with the Alpha system.

- Mark your truck's location ([Marking Your Truck Location, page 20](#)).
- Track your dogs ([Tracking Your Dog on the Map, page 12](#)).
- Track your fellow hunters ([Tracking a Contact, page 19](#)).
- Mark the location of a covey ([Marking a Covey, page 20](#)).
- View your active hunt metrics ([Active Hunt Metrics, page 20](#)).
- Send messages to your fellow hunters ([Sending a Message to Your Contacts, page 19](#)).
- Turn on the collar light ([Turning On the Collar Light, page 20](#)).
- Put the collar into rescue mode to save battery power ([Turning On Rescue Mode, page 21](#)).
- Pause tracking while you move the dogs ([Pausing Dog Tracking, page 21](#)).

Marking Your Truck Location

You can mark the location of the truck, so you can navigate back to your truck after the hunt.

- 1 Select **Mark Waypoint** > **Truck**.
- 2 Select **Save**.

Marking a Covey

You can mark a covey location and enter the estimated number of birds flushed and the number of birds taken.

- 1 Select **Mark Waypoint** > **Covey**.
- 2 Enter the number of birds flushed, the number of birds taken, and select **OK**.
- 3 Review and edit location information (optional).
- 4 Select **Save**.

Active Hunt Metrics

You can select **Hunt** from the main menu to view the active hunt metrics. The active hunt metrics page displays the active hunt time and distance traveled for your handheld device and each paired dog collar device. It also shows the dog status, such as on point, treed, or barking, if available. When you select **End Hunt**, the hunt timer and distance traveled stop recording.

Turning On the Collar Light

You can turn on the LEDs on the collar at night to help locate a dog or to warn drivers if a dog wanders near a road. The light is visible for up to 100 yards.

- 1 Select **Dog List**.
- 2 Select a dog.
- 3 Select **Adjust Collar Light**.
- 4 Select **Continuous**, **Blink Slow**, or **Blink Fast**.

TIP: Select different light setting for each dog to help you identify the dogs in the field.

Turning On Rescue Mode

You can turn on rescue mode to conserve battery power at the end of a long hunt or if your dog might get out of range.

- 1 Select **Dog List**.
- 2 Select a dog.
- 3 Select  > **Rescue Mode**.

After you have turned on rescue mode, it stays on until you turn it off.

When the collar battery power falls below 25%, the collar data updates only once every 2 minutes.

Pausing Dog Tracking

You can pause the tracking of a single dog during a hunt. This can be helpful if the dog is taking a break.

- 1 Select **Dog List**.
- 2 Select a dog.
- 3 Use the **Active** toggle switch to turn tracking on and off.

Waypoints, Routes, and Tracks

Waypoints



Waypoints are locations you record and store in the device. Waypoints can mark where you are, where you are going, or where you have been. You can add details about the location, such as name, elevation, and depth.

You can add a .gpx file that contains waypoints by transferring the file to the GPX folder ([Connecting the Handheld Device to a Computer, page 36](#)).

Marking Your Current Location

- 1 Select **Mark Waypoint**.
- 2 Select an option:
 - Select **New**.
 - Select a default location name, such as **Truck** or **Camp**.
- 3 Edit the location information (optional).
- 4 Select **Save**.

Marking a Waypoint Using the Map

- 1 Select .
- 2 Select a location on the map.
- 3 Select the information bar at the top of the screen.
- 4 Select  > **OK**.

Editing a Waypoint

Before you can edit a waypoint, you must create a waypoint.

- 1 From the main menu, select **Waypoint Manager**.
- 2 Select a waypoint.
- 3 Select an item to edit, such as the name.
- 4 Enter the new information.

Repositioning a Waypoint to Your Current Location

You can change the position of a waypoint. For example, if you move your vehicle, you can change the location to your current position.

- 1 Select **Waypoint Manager**.
- 2 Select a waypoint.
- 3 Select  > **Reposition Here**.

The waypoint location changes to your current location.

Moving a Waypoint on the Map

- 1 Select **Waypoint Manager**.
- 2 Select a waypoint.
- 3 Select  > **Move Waypoint**.
- 4 Select the new location on the map.
- 5 Select **Move**.

Increasing the Accuracy of a Waypoint Location



You can refine a waypoint location for more accuracy. When averaging, the device takes several readings at the same location and uses the average value to provide more accuracy.

- 1 Select **Waypoint Manager**.
- 2 Select a waypoint.
- 3 Select  > **Average Location**.
- 4 Move to the waypoint location.
- 5 Select **Start**.
- 6 Follow the on-screen instructions.
- 7 When the confidence status bar reaches 100%, select **Save**.

For best results, collect 4 to 8 samples for the waypoint, waiting at least 90 minutes between samples.

Projecting a Waypoint

You can create a new location by projecting the distance and bearing from a marked location to a new location.

- 1 Select **Waypoint Manager**.
- 2 Select a waypoint.
- 3 Select  > **Project Waypoint**.
- 4 Enter the bearing, and select .
- 5 Select a unit of measure.
- 6 Enter the distance, and select .
- 7 Select **Save**.

Deleting a Waypoint

- 1 Select **Waypoint Manager**.
- 2 Select a waypoint.
- 3 Select  > **Delete** > **Delete**.

Routes

A route is a sequence of waypoints or locations that leads you to your final destination.

Creating a Route

- 1 Select **Route Planner > Create Route > Select First Point**.
- 2 Select a category.
- 3 Select the first point on the route.
- 4 Select **Use > Select Next Point**.
- 5 Select a point.
- 6 Repeat steps 3 through 5 to add all the points in the route.

Editing the Name of a Route

- 1 Select **Route Planner**.
- 2 Select a route.
- 3 Select **Change Name**.
- 4 Enter the new name, and select .

Navigating a Saved Route

- 1 Select **Route Planner**.
- 2 Select a route.
- 3 Select **View Map > Go**.

Editing a Route

- 1 Select **Route Planner**.
- 2 Select a route.
- 3 Select **Edit Route**.
- 4 Select a point.
- 5 Select an option:
 - To view the point on the map, select **Review**.
 - To change the order of the points on the route, select **Move Up** or **Move Down**.
 - To insert an additional point on the route, select **Insert**.
The additional point is inserted before the point you are editing.
 - To remove the point from the route, select **Remove**.

Reversing a Route

- 1 Select **Route Planner**.
- 2 Select a route.
- 3 Select **Reverse Route**.

Viewing the Active Route

- 1 Select **Active Route**.
- 2 Select a point in the route to view additional details.

Deleting a Route

- 1 Select **Route Planner**.
- 2 Select a route.
- 3 Select **Delete Route**.

Recordings

Your device records your path as an activity. Activities contain information about points along your recorded path, including time, location, and elevation for each point.

Recording Track Logs

By default, the device automatically starts recording your path as a track when it is turned on and has acquired satellite signals. You can pause and start recording manually.

- 1 Select **Track Manager** > **My Track**.
- 2 Select an option:
 - To control the current track recording, select the current track tab.
 - To view data fields for the track, select the information tab.
 - To view the current track on the map, select the map tab.
 - To view the elevation plot for the current track, select the elevation plot tab.

Viewing Details about the Track

- 1 Select **Track Manager**.
- 2 Select a track.
- 3 Select .
The beginning and the end of the track are marked by flags.
- 4 Select the information bar along the top of the screen.
Information about the track is listed.

Viewing the Elevation Plot of a Track

- 1 Select **Track Manager**.
- 2 Select a track.
- 3 Select .

Navigating to the Start of a Track

You can navigate back to the beginning of a track. This can be helpful when finding your way back to camp or the trail head.

- 1 Select **Track Manager** > **My Track** > .
- 2 Select **TracBack**.

Changing the Track Color

- 1 Select **Track Manager**.
- 2 Select a track.
- 3 Select  > **Color**.
- 4 Select a color.

Saving the Current Track

- 1 From the main menu, select **Track Manager**.
- 2 Select **My Track** > **Save**.

Clearing the Current Track

Select **Track Manager** > **My Track** > **Discard**.

Deleting a Track

- 1 Select **Track Manager**.
- 2 Select a track.
- 3 Select  > **Delete**.

Navigation

You can navigate routes and tracks to a waypoint, geocache, or any saved location in the device. You can use the map or the compass to navigate to your destination.

Map

▲ represents your location on the map. As you travel, the icon moves and leaves a track log. Waypoint names and symbols appear on the map. When you are navigating to a destination, your route is marked with a line on the map.

When the map orientation is Track Up, objects on the map appear to rotate around your position. As you travel, the entire map reorients in the direction you are facing. You can stabilize the objects by setting the orientation to North Up ([Map Settings, page 29](#)).

To open the map, select .

Measuring Distance on the Map

You can measure the distance between two locations.

- 1 From the map, select a location.
- 2 Select  > **Measure Distance** > **Use**.
- 3 Move the pin to another location on the map.

Compass

The handheld device has a 3-axis, tilt-compensated compass. You can use a bearing pointer or a course pointer to navigate to your destination.

Calibrating the Compass

NOTICE

Calibrate the electronic compass outdoors. To improve heading accuracy, do not stand near objects that influence magnetic fields, such as vehicles, buildings, and overhead power lines.

You should calibrate the compass after moving long distances, experiencing temperature changes, or removing the battery.

- 1 Select **Compass** >  > **Calibrate Compass** > **Start**.
- 2 Follow the on-screen instructions.

Navigating with the Bearing Pointer

When navigating to a destination, ▲ points to your destination, regardless of the direction you are moving.

- 1 While navigating to a destination, select **Compass**.
- 2 Turn until ▲ points toward the top of the compass, and continue moving in that direction to the destination.

Where To? Menu

You can use the Where To? menu to find a destination to navigate to. Not all Where To? categories are available in all areas and maps.

Finding a Waypoint by Name

- 1 Select **Navigation** > **Where To?** > **Waypoints** >  > **Spell Search**.
- 2 Enter the name.
- 3 Select .

Navigating with Sight 'N Go

You can point the device at an object in the distance, lock in the direction, and navigate to the object.

- 1 Select **Navigation** > **Compass** >  > **Sight 'N Go**.
- 2 Point the device at an object.
- 3 Select **Lock Direction** > **Set Course**.



Elevation Plot

By default, the elevation plot displays the elevation for an elapsed time.



To open the elevation plot, select **Track Manager** > **My Track** > .

Calibrating the Barometric Altimeter

You can calibrate the barometric altimeter manually if you know the correct elevation or the correct barometric pressure.

- 1 Go to a location where the elevation or barometric pressure is known.
- 2 Select **Track Manager** > **My Track** >  >  > **Altimeter Setup** > **Calibrate Altimeter**.
- 3 Follow the on-screen instructions.

Navigating to a Point on the Plot

- 1 Select **Track Manager** > **My Track** > .
- 2 Select an individual point on the plot.
- 3 Select  > **View Map**.
- 4 Select **Go**.

Changing the Plot Type

You can change the elevation plot to display pressure and elevation over time or distance.

- 1 Select **Track Manager** > **My Track** >  >  > **Altimeter Setup** > **Plot Type**.
- 2 Select an option.

Resetting the Elevation Plot

Select **Track Manager** > **My Track** >  >  > **Reset**.

Trip Computer

The trip computer displays your current speed, average speed, maximum speed, trip odometer, and other helpful statistics. You can customize the trip computer layout, dashboard, and data fields ([Customizing the Trip Computer Data Fields, page 26](#)).

To open the trip computer, select Trip Computer.

Customizing the Trip Computer Data Fields

- 1 Select **Navigation** > **Trip Computer**.
- 2 Select a data field to customize.
- 3 Select a category or select **All Categories**.
- 4 Select the new data field.
For data field descriptions, see [Data Field Options, page 44](#).

Resetting the Trip Computer

For more accurate trip information, reset the trip computer before beginning a trip.

Select **Navigation** > **Trip Computer** >  > **Reset Trip**.

Applications

Additional device features can be found in the applications. You can customize the main menu to display additional applications (*Customizing the Main Menu, page 28*).

Setting a Proximity Alarm

Proximity alarms alert you when you or your dogs are within a specified range of a particular location. A tone sounds when you enter the designated radius.

- 1 Select **Proximity Alarms**.
- 2 Select **Create Alarm**.
- 3 Select a category.
- 4 Select a location.
- 5 Select **Use**.
- 6 Enter a radius.

When you enter an area with a proximity alarm, the device sounds a tone.

Calculating the Size of an Area

- 1 Select **Area Calculation > Start**.
- 2 Walk around the perimeter of the area you want to calculate.
- 3 When finished, select **Calculate**.

Setting an Alarm

- 1 Select **Alarm Clock**.
- 2 Select **+** and **-** to set the time.
- 3 Select **Turn Alarm On**.

The alarm sounds at the selected time. If the device is off at the alarm time, the device turns on and sounds the alarm.

Using the Competition Timer

- 1 Select **Competition Timer**.
- 2 Select an option:
 - Select **▶** to start and pause the competition timer.
 - Select **↻** to reset the competition timer.
 - Select **✂** to set the competition timer duration and alerts.
 - Select **+** from the list to create a customized timer that counts up from zero.

Satellite Page

The satellite page shows your current location, GPS accuracy, satellite locations, and signal strength.

Changing the Satellite View

By default, the satellite view is with North at the top. You can change the view of the satellites to be oriented with your current track toward the top of the screen.

Select **Satellite** > **≡** > **Track Up**.

Turning Off GPS

Select **Satellite** > **≡** > **Satellite Setup** > **Satellite System** > **Demo Mode**.

Simulating a Location

- 1 Select **Satellite** >  > **Satellite Setup** > **Satellite System** > **Demo Mode**.
- 2 Select  > **Set Location On Map**.
- 3 Select a location.
- 4 Select **Use**.

Downloading BirdsEye Imagery

Before you can download BirdsEye imagery directly to your device, you must connect to a wireless network ([Connecting to a Wireless Network, page 17](#)).

- 1 Select **BirdsEye Direct** > **Download Imagery**.
- 2 Select an option:
 - To download BirdsEye imagery files for a specific location or area, select **Location**, and select a category.
NOTE: The location defaults to your current location.
 - To edit the name of the downloaded imagery files, select **Name**.
 - To select an image quality option, select **Detail**.
 - To define the size of the area to be shown in the downloaded imagery files, select **Radius**, and enter a distance from the selected location.

An estimated file size appears for the selected image quality and radius. You should verify your device has enough available storage space for the imagery file.
- 3 Select **Download**.

Customizing Your Device

Customizing the Main Menu

- 1 From the main menu, select **Setup** > **Main Menu**.
- 2 Select an option:
 - To move a menu item, select a menu item, and select a new location.
 - To delete a menu item from the list, select a menu item, and select **Remove**.
 - To add a new menu item to the list, or to place an item on the list after you have removed it, select **Add Item Here**.
 - To reset the order of all items in the menu, select  > **Restore Defaults**.

Customizing the Data Fields

You can customize the data fields and dashboards of the map, compass, elevation plot, and trip computer.

- 1 Open the page for which you will change the data fields.
- 2 Select a data field to customize.
- 3 Select the new data field.
For data field descriptions, see [Data Field Options, page 44](#).

System Settings

Select **Setup > System**.

Satellite: Sets the satellite system options and enables or disables the use of Wide Area Augmentation System/European Geostationary Navigation Overlay Service (WAAS/EGNOS) data.

Language: Sets the text language on the device.

NOTE: Changing the text language does not change the language of user-entered data or map data, such as street names.

Mass Storage Mode: Sets whether your device goes into mass storage mode when it is connected to the computer.

Broadcast Dog Data: Automatically sends dog data to compatible devices.

Units: Sets the units of measure.

Time: Sets the time zone and format.

Display Settings

Select **Setup > Display**.

Backlight Timeout: Adjusts the length of time before the backlight turns off.

Battery Save: Saves the battery power and prolongs the battery life by turning off the screen when the backlight times out (*Turning On the Handheld Battery Save Mode, page 35*).

Appearance: Sets the displayed accent colors for day and night.

Screen Capture: Allows you to save the image on the device screen.

Accessibility: Adds or changes device features to make your device more accessible (*Accessibility Settings, page 29*).

Accessibility Settings

Select **Setup > Display > Accessibility**.

Touch Sensitivity: Sets the touchscreen sensitivity.

Review Text Size: Adjusts the size of the text.

Scroll Controls: Adds scroll arrows to the screen when a menu, list, or grid is scrollable.

Setting the Device Tones

You can customize tones for messages, keys, warnings, and alarms.

- 1 Select **Setup > Tones & Alerts**.
- 2 Select a tone for each audible type.

Setting Dog Alerts

You can adjust how the handheld device alerts you to certain actions of the dog.

- 1 Select **Setup > Tones & Alerts > Dog Alerts**.
- 2 Select an action.
- 3 Select the method the device uses to alert you for this action.

Map Settings

Select **Setup > Map**.

Configure Maps: Enables or disables the maps currently loaded on the device.

Tracked Devices: Opens the map settings options for tracked devices (*Tracked Devices Map Settings, page 30*).

Show Training Bar: Displays the training bar on the map.

Show Data Fields: Displays configurable data fields on the map.

Advanced: Opens the advanced map settings (*Advanced Map Settings, page 30*).

Tracked Devices Map Settings

Select **Setup > Map > Tracked Devices**.

Auto Zoom: Allows the map to zoom out automatically, so the selected devices are always displayed on the map.

Dog Tracks on Map: Determines how much of the track log for a tracked dog collar appears on the map.

Handheld Tracks on Map: Determines how much of the track log for a tracked handheld device appears on the map.

Dog Display: Enables and disables the dog information shown on the map.

Show Offscreen Dogs: Enables or disables the offscreen dog indicator on the map.

Advanced Map Settings

Select **Setup > Map > Advanced**.

Orientation: Adjusts how the map is shown on the page. North Up shows North at the top of the page. Track Up shows your current direction of travel toward the top of the page. Automotive Mode shows an automotive perspective with the direction of travel at the top.

Shaded Relief: Shows detail relief on the map (if available) or turns off shading.

Map Pointer: Displays the directional pointer on the map.

Text Size: Sets the text size for map items.

Tracks Settings

Select **Setup > Tracks**.

Record Method: Sets how the device records track data. The Smart recording option allows for longer track recordings. The Every Second recording option provides more detailed track recordings, but may not record entire tracks that last for longer periods of time.

Auto Save: Allows you to customize the Auto Save settings ([Auto Save Settings, page 30](#)).

Auto Start: Starts recording a track automatically when the device acquires satellites.

Auto Save Settings

When Full: Automatically saves the current recording and starts a new one when the current recording is near 20,000 track points.

Daily: Automatically saves the previous day's recording and starts a new one when you turn on the device during a new day.

Weekly: Automatically saves the previous week's recording and starts a new one when you turn on the device during a new week.

Auto: Automatically saves the current recording based on its length and the number of track points taken.

Never: Never saves the current recording automatically. When the current recording nears 20,000 track points, the device filters the active track to remove redundant points while retaining the shape and history of the recording. Unfiltered points are saved in a temporary GPX and FIT file that is saved or discarded when the recording stops.

NOTE: When importing FIT activities or GPX tracks with more than 20,000 track points, the device filters the line to fit in the device memory and improve map drawing performance, while retaining the shape and history of the recording. The FIT and GPX files retain all of their original track points.

Routing Settings

The available routing settings vary based on whether Direct Routing is enabled or disabled.

Select **Setup > Routing**.

Direct Routing: Enables or disables direct routing. Direct routing calculates the most direct route possible to the destination.

Activity: Sets an activity while routing. The device calculates routes optimized for the type of activity you are doing.

Calculation Method: Sets the method used to calculate your route.

Lock On Road: Locks the blue triangle, which represents your position on the map, onto the nearest road. This is most useful when driving or navigating on roads.

Off Route Recalculation: Sets recalculation preferences when navigating away from an active route.

Avoidance Setup: Sets the types of roads, terrain, and transportation methods to avoid while navigating.

Route Transitions: Sets how the device routes from one point on the route to the next. This setting is available only for some activities. The Distance option routes you to the next point on the route when you are within a specified distance of your current point.

Sensors Settings

Select **Setup > Sensors**.

Tempe Sensor: Allows you to pair a tempe™ sensor and turn a paired tempe sensor on and off.

Xero: Allows you to enable or disable your sharing status and make sharing public or private.

NOTE: You can share your location from a compatible Xero® device.

Changing the Units of Measure

You can customize units of measure for distance and speed, elevation, and temperature.

- 1 Select **Setup > System > Units**.
- 2 Select a measurement type.
- 3 Select a unit of measure for the setting.

Position Format Settings

NOTE: You should not change the position format or the map datum coordinate system unless you are using a map or chart that specifies a different position format.

Select **Setup > System > Units > Position Format**.

Position Format: Sets the position format in which a location reading appears.

Map Datum: Sets the coordinate system on which the map is structured.

Map Spheroid: Shows the coordinate system the device is using. The default coordinate system is WGS 84.

Device Information

Viewing E-label Regulatory and Compliance Information

The label for this device is provided electronically. The e-label may provide regulatory information, such as identification numbers provided by the FCC or regional compliance markings, as well as applicable product and licensing information.

- 1 Select **Setup**.
- 2 Select **About**.

Support and Updates

- You can update software and maps for your handheld device and compatible dog collar device using Garmin Express™.
- Go to support.garmin.com for FAQs, videos, and more information.

Product Updates

On your computer, install Garmin Express (www.garmin.com/express).

This provides easy access to these services for Garmin devices:

- Software updates
- Map updates
- Product registration

Device Care

NOTICE

Do not store the device where prolonged exposure to extreme temperatures can occur, because it can cause permanent damage.

Never use a hard or sharp object to operate the touchscreen, or damage may result.

Avoid chemical cleaners, solvents, and insect repellents that can damage plastic components and finishes.

Secure the weather cap tightly to prevent damage to the USB port.

Avoid extreme shock and harsh treatment, because it can degrade the life of the product.

Cleaning the Device

NOTICE

Even small amounts of sweat or moisture can cause corrosion of the electrical contacts when connected to a charger. Corrosion can prevent charging and data transfer.

- 1 Wipe the device using a cloth dampened with a mild detergent solution.
- 2 Wipe it dry.

After cleaning, allow the device to dry completely.

Cleaning the Touchscreen

- 1 Use a soft, clean, lint-free cloth.
- 2 If necessary, lightly dampen the cloth with water.
- 3 If using a dampened cloth, turn off the device and disconnect the device from power.
- 4 Gently wipe the screen with the cloth.

Specifications

Alpha Handheld Device Specifications

Battery type	Rechargeable, replaceable lithium-ion ¹
Battery life	Up to 20 hr.
Operating temperature range	From -20° to 60°C (from -4° to 140°F)
Charging temperature range	From 0° to 45°C (from 32° to 113°F)
Long-term storage temperature range	From 0° to 25°C (from 32° to 77°F)
VHF wireless range	Up to 14.5 km (9 mi.)
ANT+ low power wireless range	About 3 m (10 ft.)
Wireless frequencies/protocols	152-169 MHz @ 32.5 dBm maximum, 2.4 GHz @ 14.8 dBm maximum
SAR (body)	0.66 W/kg simultaneous
Water rating	IEC 60529 IPX7 ²

Dog Collar Device Specifications

Battery type	Rechargeable, replaceable lithium-ion
Battery life	From 20 to 40 hr. Battery life is determined by the handheld device in use.
Operating temperature range	From -20° to 60°C (from -4° to 140°F)
Charging temperature range	From 0° to 40°C (from 32° to 104°F)
ANT [®] wireless range	Up to 10 m (32.8 ft.)
VHF radio range	Up to 14.48 km (9 mi.)
Wireless frequencies/protocols	152-155 MHz @ 31.6 dBm maximum, 2.4 GHz @ 23.1 dBm maximum
Water rating	1 ATM ³

Mini Dog Collar Device Specifications

Battery type	Rechargeable, replaceable lithium-ion
Battery life	Up to 16 to 30 hr., typical use
Operating temperature range	From -20° to 60°C (from -4° to 140°F)
Charging temperature range	From 5° to 40°C (from 41° to 104°F)
ANT wireless range	Up to 5 m (16.4 ft.)
VHF radio range	Up to 6.44 km (4 mi.)
Wireless frequencies/protocols	152-155 MHz @ 31.6 dBm maximum, 2.4 GHz @ 23.1 dBm maximum
Water rating	1 ATM ³

¹ Only for use with Garmin part number 361-00053-04.

² The device withstands incidental exposure to water of up to 1 m for up to 30 min. For more information, go to www.garmin.com/waterrating.

³ The device withstands pressure equivalent to a depth of 10 m. For more information, go to www.garmin.com/waterrating.

Battery Information

WARNING

This product contains a lithium-ion battery. To prevent the possibility of personal injury or product damage caused by battery exposure to extreme heat, store the device out of direct sunlight.

Do not use a sharp object to remove batteries.

CAUTION

Contact your local waste disposal department to properly recycle the batteries.

Long-Term Storage

NOTICE

The normal long-term decrease in the charging capacity of lithium-ion batteries can be accelerated by exposure to elevated temperatures. Storing a fully charged device in a location with a temperature outside the long-term storage temperature range can significantly reduce its recharging capacity.

When you do not plan to use the handheld device for several months, the battery should be removed. Stored data is not lost when the battery is removed.

When you do not plan to use the collar for several months, the battery should be charged to about 50%. The device should be stored in a cool, dry place with temperatures around the typical household level. After storage, the collar should be fully recharged before use.

Maximizing the Battery Life

You can do several things to extend the life of the batteries in the handheld device and collar.

- Reduce the backlight brightness (*Adjusting the Backlight Brightness, page 34*).
- Reduce the backlight timeout (*Adjusting the Backlight Timeout, page 34*).
- Turn off the transmitter (*Turning On and Off the Transmitter, page 18*).
- Use battery save mode (*Turning On the Handheld Battery Save Mode, page 35*).
- Put the dog collar device into rescue mode to conserve the collar battery (*Turning On Rescue Mode, page 21*).
- Extend the duration for the collar update rate to conserve the collar battery (*Changing the Dog Collar Device Update Rate, page 35*).

Adjusting the Backlight Brightness

Extensive use of screen backlighting can significantly reduce battery life. You can adjust the backlight brightness to maximize the battery life.

NOTE: The backlight brightness may be limited when the battery is low.

1 Select .

2 Use the slider bar to adjust the backlight brightness.

The device may feel warm when the backlight setting is high.

Adjusting the Backlight Timeout

You can decrease the backlight timeout to maximize the battery life.

1 Select **Setup > Display > Backlight Timeout**.

2 Select an option.

Changing the Dog Collar Device Update Rate

Before you can change the collar update rate, the collar must be turned on and within range of the handheld device.

You can select a longer duration for the update rate to conserve battery power.

- 1 Select **Dog List**.
- 2 Select a dog.
- 3 Select **Update Rate**.
- 4 Select an option.

Turning On the Handheld Battery Save Mode

You can use battery save mode to prolong the battery life.

Select **Setup > Display > Battery Save > On**.

When in battery save mode, the screen shuts off when the backlight times out.

Saving Energy While Charging the Device

You can turn off the device display and all other features while charging.

- 1 Connect your device to an external power source.
The remaining battery capacity appears.
- 2 Hold the power key for 4 to 5 seconds.
The display turns off, and the device goes into a low power, battery charging mode.
- 3 Charge the device completely.

Data Management

The device has a memory card slot for additional data storage.

NOTE: The device is compatible with Windows® 7 and newer, and Mac® OS 10.4 and newer.

Installing a Memory Card

⚠ WARNING

Do not use a sharp object to remove user-replaceable batteries.

You can install a microSD memory card in the handheld device for additional storage or pre-loaded maps.

- 1 Turn the D-ring counter-clockwise, and pull up to remove the cover.
- 2 Remove the battery.
- 3 Slide the card holder to the left and lift up.

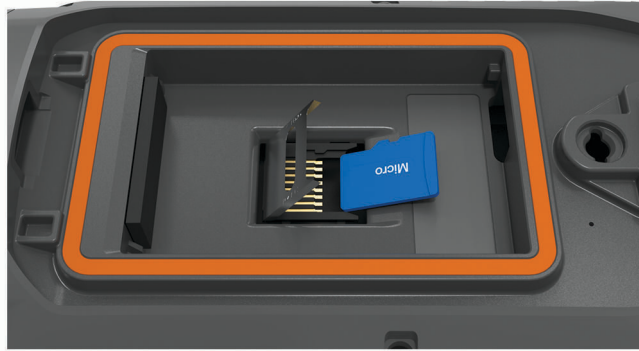

- 4 Place the memory card with the gold contacts facing down.
- 5 Close the card holder.
- 6 Slide the card holder to the right to lock it.
- 7 Replace the battery and cover.

Connecting the Handheld Device to a Computer

NOTICE

To prevent corrosion, thoroughly dry the USB port, the weather cap, and the surrounding area before charging or connecting to a computer.

- 1 Lift the weather cap ①.



- 2 Plug the small end of the USB cable into the USB connector ② on the device.
- 3 Plug the other end of the USB cable into an available USB port on the computer.
Your device appears as a removable drive in My Computer on Windows computers and as mounted volumes on Mac computers.

Connecting the Collar to a Computer

NOTICE

To prevent corrosion, you should dry the contacts on the collar and the surrounding area before connecting the charging clip.

- 1 Snap the charging clip onto the collar.
- 2 Plug the small end of the USB cable into the USB port on the charging clip cable.
- 3 Plug the other end of the USB cable into a USB port on the computer.

Transferring Dog Tracks to BaseCamp™

You can transfer the dog tracks to BaseCamp.

- 1 Connect the dog collar device to the computer ([Connecting the Collar to a Computer, page 37](#)).
The dog collar device turns on automatically.
- 2 Select  on the dog collar device.
- 3 Open BaseCamp.
BaseCamp recognizes the device.
- 4 Select **Device > Receive from Device**.
- 5 Select the dog collar device from the list, and click **OK**.

BaseCamp creates a folder of transferred data in **My Collection**.

Deleting Files

NOTICE

If you do not know the purpose of a file, do not delete it. Your device memory contains important system files that should not be deleted.

- 1 Open the **Garmin** drive or volume.
- 2 If necessary, open a folder or volume.
- 3 Select a file.
- 4 Press the **Delete** key on your keyboard.
NOTE: If you are using an Apple® computer, you must empty the Trash folder to completely remove the files.

Disconnecting the USB Cable

If your device is connected to your computer as a removable drive or volume, you must safely disconnect your device from your computer to avoid data loss. If your device is connected to your Windows computer as a portable device, it is not necessary to safely disconnect the device.

- 1 Complete an action:
 - For Windows computers, select the **Safely Remove Hardware** icon in the system tray, and select your device.
 - For Apple computers, select the device, and select **File > Eject**.
- 2 Disconnect the cable from your computer.

Resetting Data and Settings

The device offers options for deleting your user data and resetting all settings to the factory default values.

- 1 Select **Setup > Reset**.
- 2 Select an option:
 - To reset all settings to the default values and save all user-entered information, select **Reset All Settings**.
 - To delete all user data and reset all settings to the factory default values, select **Delete All**.

Appendix

Accessories and Replacement Parts

Purchasing Accessories

- Optional accessories are available at garmin.com or from your Garmin dealer.

Optional Maps

You can use additional maps with the device, such as BirdsEye satellite imagery, City Navigator®, and Garmin HuntView™ Plus detailed maps. Detailed maps may contain additional points of interest, such as restaurants or marine services. For more information, go to buy.garmin.com or contact your Garmin dealer.

tempe

The tempe is an ANT+ wireless temperature sensor. You can attach the sensor to a secure strap or loop where it is exposed to ambient air, and therefore, provides a consistent source of accurate temperature data. You must pair the tempe with your device to display temperature data from the tempe.

Tips for Pairing ANT+ Accessories with Your Garmin Device

- Verify that the ANT+ accessory is compatible with your Garmin device.
- Before you pair the ANT+ accessory with your Garmin device, move 10 m (33 ft.) away from other ANT+ accessories.
- Bring the Garmin device within range 3 m (10 ft.) of the ANT+ accessory.
- After you pair the first time, your Garmin device automatically recognizes the ANT+ accessory each time it is activated. This process occurs automatically when you turn on the Garmin device and only takes a few seconds when the accessories are activated and functioning correctly.
- When paired, your Garmin device receives data from only your accessory, and you can go near other accessories.

Dog Collar Device Battery Replacement Instructions

Dog Collar Device Components

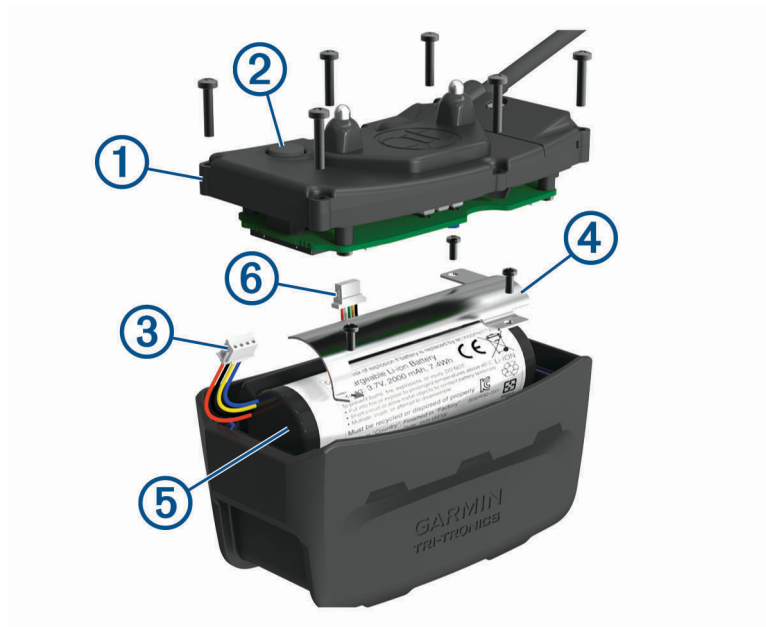

①	Back plate
②	Power key
③	Battery connector
④	Battery cover
⑤	Battery
⑥	Power connector

Removing the Old Battery

Before you replace the battery, you must remove all dirt, water, and debris from the device. You must also have a small Phillips screwdriver.

- 1 Remove the six screws from the outer edges of the back plate.

NOTE: You should leave the two inner screws in place.

- 2 Pry off the back plate.
- 3 Disconnect the battery connector and power connector.
- 4 Remove the screws that secure the battery cover.
- 5 Remove the battery cover and the battery.

Remember the orientation of the battery. You must install the new battery the same way.

After you remove the old battery, contact your local waste disposal department to properly recycle the battery.

Installing the New Battery

Before you replace the battery, you must remove the old battery (*Removing the Old Battery, page 39*). You also must have a small Phillips screwdriver. You may need a small flat screwdriver.

- 1 Install the new battery using the same orientation as the old battery.

The connector ① should face the end nearest the power key, and the bump ② where the wires connect to the battery should face toward the side with the charging clip contacts.

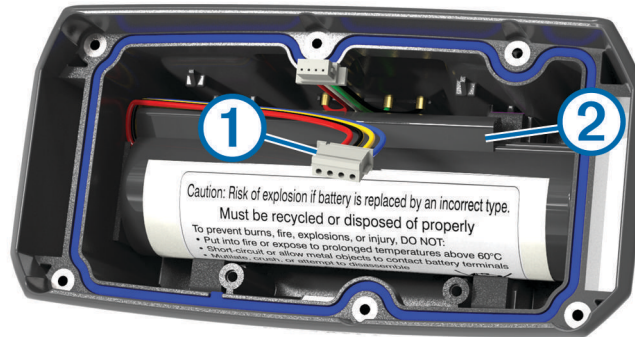

- 2 Replace the battery cover.
 - 3 Replace the screws to secure the battery cover.
 - 4 Connect the battery connector and power connector.
You may need to use a flat screwdriver to help secure the connectors.
 - 5 Select the power key to test the connections.
When properly connected, a tone is emitted and the status LED blinks green.
 - 6 Turn off the device.
 - 7 Verify the gasket located inside the bottom cover is fully seated.
 - 8 Replace the back plate.
 - 9 Replace the six screws to secure the back plate.
- After you install the new battery, charge the collar completely.

Replacing the Mini Dog Collar Device Battery

Before you can replace the battery, you must remove all dirt, water, and debris from the device. You also need a small Phillips screwdriver and the security screwdriver included in the battery replacement kit.

- 1 Remove the screws from the L-shaped cover over the VHF antenna.
- 2 Pry off the L-shaped cover.
- 3 Remove the screws from the outer edges of the back plate.
- 4 Pry off the back plate.
- 5 Grip the battery connector wires close to the connector, and pull the connector perpendicular to the circuit board to disconnect the battery connector from the device.
- 6 Grip the power connector wires close to the connector, and pull the connector parallel to the circuit board to disconnect the power connector from the device.
- 7 Remove the screws from the battery plate.
- 8 Remove the battery plate.
- 9 Remove the battery.
The battery fits tightly. It may be necessary to pry the battery out of the back plate using a non-sharp, non-metal object.
- 10 Install the new battery into the front enclosure with the label side of the battery facing up, and the leading edge of the battery placed under the charging contact ledge of the device.
- 11 Replace the battery plate, and replace and tighten the two screws.

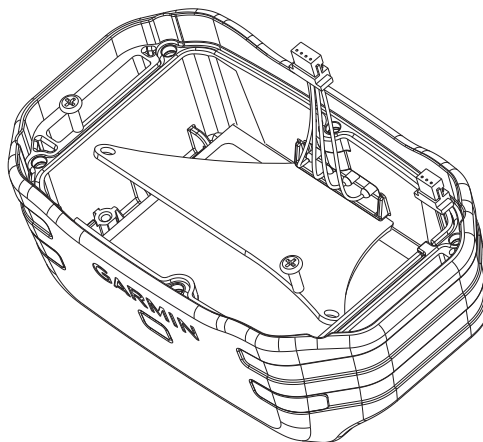

- 12 Verify the gasket is not damaged and is completely seated in the groove.
- 13 Connect the battery connector and the power connector to the device.
When properly installed, the connector plugs snap into the ports.
- 14 Replace the back plate, and replace and tighten the screws to secure the back plate.
- 15 Replace the L-shaped cover, and replace and tighten the screws to secure the L-shaped plate.
- 16 Verify the gasket is not sticking out of the device.

Replacing the Collar Strap

Before you replace the collar strap, you must remove all dirt, water, and debris from the device ([Cleaning the Device, page 32](#)).

- 1 Pull the collar strap out of the GPS antenna, antenna guide, and the dog device.
You may need to push and pull the collar strap to properly remove it. You may need to loosen the screw on the GPS antenna case, but do not remove them.
- 2 Thread the new collar strap through the dog device, antenna guide, and GPS antenna.
- 3 If necessary, tighten the screws that secure the GPS antenna case.

Replacing the VHF Antenna in the Dog Collar Device

NOTICE

Do not excessively bend the band that connects the main device case with the GPS antenna.

When the L-shaped cover is removed, do not disturb the sealant opposite the VHF antenna, because this can damage the waterproof seal of the dog collar device.

Before you replace the VHF antenna, you must remove all dirt, water, and debris from the device (*Cleaning the Device*, page 32). Also, you need a small Phillips screwdriver.

- 1 Remove the 4 screws ① from the L-shaped cover over the VHF antenna.

NOTE: You should note the location of the one short screw.

- 2 Pry off the L-shaped cover.

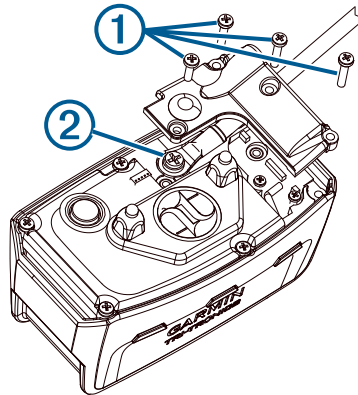

- 3 Remove the screw ② securing the VHF antenna to the back plate.
- 4 Pull the length of the antenna from the antenna guide to remove the old antenna.
- 5 Loop the antenna guide around the collar strap, and thread the new VHF antenna through the guide. This helps to point the antenna up.
- 6 Replace the screw securing the VHF antenna to the back plate.
- 7 Replace the L-shaped cover over the VHF antenna.
- 8 Replace the 4 screws on the L-shaped cover, replacing the short screw in the correct location.

Changing the Fuse in the Vehicle Power Cable

NOTICE

When replacing the fuse, do not lose any of the small pieces and make sure they are put back in the proper position. The vehicle power cable does not work unless it is assembled correctly.

If your device does not charge in your vehicle, you may need to replace the fuse located at the tip of the vehicle adapter.

- 1 Rotate the end piece ① counter clockwise to unlock it.



TIP: You may need to use a coin to remove the end piece.

- 2 Remove the end piece, the silver tip ②, and the fuse ③.
- 3 Insert a new fast-blow fuse that has the same current, such as 1 A or 2 A.
- 4 Place the silver tip in the end piece.
- 5 Push in the end piece and rotate it clockwise to lock it back into the vehicle power cable ④.

Data Field Options

24 hr. Max. Temperature: The maximum temperature recorded in the last 24 hours.

24 hr. Min. Temperature: The minimum temperature recorded in the last 24 hours.

Accuracy of GPS: The margin of error for your exact location. For example, your GPS location is accurate to within +/- 12 ft. (3.65 m).

Alarm Timer: The current time of the countdown timer.

Ambient Pressure: The uncalibrated environmental pressure.

Ascent - Average: The average vertical distance of ascent since the last reset.

Ascent - Maximum: The maximum rate of ascent in feet per minute or meters per minute since the last reset.

Ascent - Total: The total elevation distance ascended since the last reset.

Automotive Turn: The direction of the next turn in the route. You must be navigating for this data to appear.

Average Lap: The average lap time for the current activity.

Barometer: The calibrated current pressure.

Battery Level: The remaining battery power.

Bearing: The direction from your current location to a destination. You must be navigating for this data to appear.

Calories: The amount of total calories burned.

Compass Heading: The direction you are moving based on the compass.

Course: The direction from your starting location to a destination. Course can be viewed as a planned or set route. You must be navigating for this data to appear.

Current Lap: The stopwatch time for the current lap.

Date: The current day, month, and year.

Descent - Average: The average vertical distance of descent since the last reset.

Descent - Maximum: The maximum rate of descent in feet per minute or meters per minute since the last reset.

Descent - Total: The total elevation distance descended since the last reset.

Distance to Dest.: The remaining distance to the final destination. You must be navigating for this data to appear.

Distance to Next: The remaining distance to the next waypoint on the route. You must be navigating for this data to appear.

Elapsed Track Time: The total time recorded. For example, if you start the timer and run for 10 minutes, then stop the timer for 5 minutes, then start the timer and run for 20 minutes, your elapsed time is 35 minutes.

Elevation: The altitude of your current location above or below sea level.

Elevation Above Ground: The altitude of your current location above ground level (if maps contain sufficient elevation information).

Elevation - Maximum: The highest elevation reached since the last reset.

Elevation - Minimum: The lowest elevation reached since the last reset.

ETA at Destination: The estimated time of day when you will reach the final destination (adjusted to the local time of the destination). You must be navigating for this data to appear.

ETA at Next: The estimated time of day when you will reach the next waypoint on the route (adjusted to the local time of the waypoint). You must be navigating for this data to appear.

Glide Ratio: The ratio of horizontal distance traveled to the change in vertical distance.

Glide Ratio to Dest.: The glide ratio required to descend from your current position to the destination elevation. You must be navigating for this data to appear.

GPS Elevation: The altitude of your current location using GPS.

GPS Heading: The direction you are moving based on GPS.

GPS Signal Strength: The strength of the GPS satellite signal.

Grade: The calculation of rise (elevation) over run (distance). For example, if for every 10 ft. (3 m) you climb you travel 200 ft. (60 m), the grade is 5%.

Heading: The direction you are moving.

Lap Ascent: The vertical distance of ascent for the current lap.

Lap Descent: The vertical distance of descent for the current lap.

Lap Distance: The distance traveled for the current lap.

Laps: The number of laps completed for the current activity.

Lap Speed: The average speed for the current lap.

Last Lap Ascent: The vertical distance of ascent for the last completed lap.

Last Lap Descent: The vertical distance of descent for the last completed lap.

Last Lap Distance: The distance traveled for the last completed lap.

Last Lap Speed: The average speed for the last completed lap.

Last Lap Time: The stopwatch time for the last completed lap.

Location (lat/lon): The current position in latitude and longitude regardless of the selected position format setting.

Location (selected): The current position using the selected position format setting.

Location of Dest.: The position of your final destination. You must be navigating for this data to appear.

None: This is a blank data field.

Odometer: A running tally of distance traveled for all trips. This total does not clear when resetting the trip data.

Off Course: The distance to the left or right by which you have strayed from the original path of travel. You must be navigating for this data to appear.

Pointer: An arrow points in the direction of the next waypoint or turn. You must be navigating for this data to appear.

Speed: The current rate of travel.

Speed Limit: The reported speed limit for the road. Not available in all maps and in all areas. Always rely on posted road signs for actual speed limits.

Speed - Maximum: The highest speed reached since the last reset.

Speed - Moving Avg.: The average speed while moving since the last reset.

Speed - Overall Avg.: The average speed while moving and stopped since the last reset.

Stopwatch Timer: The stopwatch time for the current activity.

Sunrise: The time of sunrise based on your GPS position.

Sunset: The time of sunset based on your GPS position.

Temperature: The temperature of the air. Your body temperature affects the temperature sensor.

Time of Day: The current time of day based on your current location and time settings (format, time zone, daylight saving time).

Time to Destination: The estimated time remaining before you reach the destination. You must be navigating for this data to appear.

Time to Next: The estimated time remaining before you reach the next waypoint in the route. You must be navigating for this data to appear.

To Course: The direction in which you must move to get back on the route. You must be navigating for this data to appear.

Total Lap: The stopwatch time for all the completed laps.

Trip Odometer: A running tally of the distance traveled since the last reset.

Trip Time: A running tally of the total time spent moving and not moving since the last reset.

Trip Time - Moving: A running tally of the time spent moving since the last reset.

Trip Time - Stopped: A running tally of the time spent not moving since the last reset.

Turn: The angle of difference (in degrees) between the bearing to your destination and your current course. L means turn left. R means turn right. You must be navigating for this data to appear.

Velocity Made Good: The speed at which you are closing on a destination along a route. You must be navigating for this data to appear.

Vertical Dist. to Dest.: The elevation distance between your current position and the final destination. You must be navigating for this data to appear.

Vertical Dist. to Next: The elevation distance between your current position and the next waypoint in the route. You must be navigating for this data to appear.

Vertical Speed: The rate of ascent or descent over time.

Vertical Speed to Dest.: The rate of ascent or descent to a predetermined altitude. You must be navigating for this data to appear.

Waypoint at Dest.: The last point on the route to the destination. You must be navigating for this data to appear.

Waypoint at Next: The next point on the route. You must be navigating for this data to appear.

Index

A

- accessories **38**
- activities **23**
- alarms
 - clock **27**
 - proximity **27**
 - tones **29**
- alerts **19**
 - dog **29**
 - location **13, 14**
- altimeter, calibrating **26**
- ANT+ sensors, pairing **38**
- applications **17, 18**
- area calculation **27**

B

- backlight **34, 35**
- BaseCamp **37**
- battery **34, 39**
 - charging **5, 35**
 - installing **5**
 - life **29**
 - maximizing **11, 21, 34, 35**
 - replacing **39–41**
 - storage **34**
- beacon **20**
- bearing pointer **25**
- Bluetooth technology **17**

C

- calibrating, altimeter **26**
- charging **35**
 - collar **6**
 - handheld **5**
- cleaning the device **32**
- cleaning the touchscreen **32**
- collar **11**
 - charging **6**
 - contact points **15**
 - fitting **10**
 - light **20**
 - replacing battery **39, 40**
 - replacing strap **41**
 - VHF antenna **4, 42**
- compass **13, 25**
 - calibrating **25**
 - navigating **25**
- computer, connecting **35–37**
- contact **18, 19**
 - adding **18, 19**
 - ID **19, 20**
 - viewing on map **19**
- contact points **10, 15**
- covey, marking **20**

D

- data
 - sharing **14**
 - sharing data **14**
 - storing **18**
 - transferring **18**
- data fields **26, 28**
- deleting, all user data **37**
- device, care **32**
- display settings **29**
- dog **7, 9, 10, 18, 27**
 - adding **7, 8**
 - alerts **14, 29**
 - collar **21**
 - ID **8, 10**
 - information **9, 10**
 - navigating to **13**
 - statistics **9, 20**
 - track and control codes **8**

- tracking **11–14, 21**
- tracks **9, 13, 37**
- training **15, 16**
- training basics **14, 17**
- training intensity levels **15**
- type **9**
- update rate **35**

E

- elevation **24, 26**
 - plot **26**

F

- fuse, changing **43**

G

- Garmin Express
 - registering the device **32**
 - updating software **32**
- geofences **13, 14**
- GPS **27, 28**
 - settings **29**

H

- history, sending to computer **18**
- hunter **18**

I

- icons **12**
- initial setup **6**
- intensity level, choosing **15**

K

- keys **2, 3**
 - training **16**

L

- line-of-sight radio communication **11**

M

- main menu, customizing **28**
- maps **21, 24**
 - BirdsEye imagery **28**
 - measuring distances **25**
 - navigation **25**
 - optional **38**
 - orientation **25, 29**
 - settings **29, 30**
 - updating **32**
 - zoom **12, 30**
- measuring distances **25**
- memory card **2, 36**
- messages **19**
- microSD card. See memory card
- MicroSD card. See memory card

N

- navigation **13, 25, 26**
 - altimeter **26**

O

- on-screen buttons **6**

P

- pairing
 - ANT+ sensors **38**
 - smartphone **17**
- position format **31**
- power cables, changing the fuse **43**
- power key **2, 3, 6**
- product registration **32**
- proximity alarms **27**

R

- radio communication **11**
- radio frequencies **9**
- registering the device **32**
- replacement parts **38–42**
- rescue mode **21**

- resetting the device **37**
- routes **22, 23**
 - creating **23**
 - deleting **23**
 - editing **23**
 - navigating **23**
 - settings **31**

S

- satellite signals **27, 28**
 - acquiring **7**
- settings **16, 29–31**
 - device **30, 31**
 - recording **30**
- Sight 'N Go **26**
- sleep mode **11**
- smartphone **18**
 - applications **17**
 - pairing **17**
- software
 - updates **32**
 - updating **32**
- specifications **33**
- storing data **18**

T

- tempe **31, 38**
- Tempe **31**
- temperature **38**
- tones **29**
- TracBack **24**
- tracks **13, 24**
 - navigating **24**
 - recording **24**
 - settings **30**
- training
 - stimulation **15**
 - tone **15**
 - vibration **15**
- transferring, tracks **37**
- trip information
 - resetting **26**
 - viewing **26**
- trip planner. See routes
- troubleshooting **37**

U

- units of measure **31**
- updates, software **32**
- USB
 - connector **2**
 - disconnecting **37**
- user data, deleting **37**

V

- VHF antenna **2, 42**

W

- waypoints **21, 25**
 - deleting **22**
 - editing **21, 22**
 - projecting **22**
 - saving **20, 21**
- Wi-Fi **17**
 - connecting **17**

Z

- zooming, maps **12**

