

# BT-620

## OPERATION MANUAL



### **Met One Instruments, Inc**

Corporate Sales & Service: 1600 NW Washington Blvd. Grants Pass, OR 97526

Tel (541) 471-7111 Fax (541) 471-7116

[www.metone.com](http://www.metone.com) - [service@metone.com](mailto:service@metone.com)

## Copyright Notice

BT-620 Manual

© Copyright 2012 Met One Instruments, Inc. All Rights Reserved Worldwide. No part of this publication may be reproduced, transmitted, transcribed, stored in a retrieval system, or translated into any other language in any form by any means without the express written permission of Met One Instruments, Inc.

## Technical Support

Should you require support, please consult your printed documentation or our website [www.metone.com](http://www.metone.com) to resolve your problem. If you are still experiencing difficulty, you may contact a Technical Service representative during normal business hours:

7:00 a.m. to 4:00 p.m. Pacific Time, Monday through Friday.

Voice: (541) 471-7111

Fax: (541) 471-7116

E-Mail: [service@metone.com](mailto:service@metone.com)

Mail: Technical Services Department  
Met One Instruments, Inc.  
1600 NW Washington Blvd.  
Grants Pass, OR 97526

### NOTICE



**CAUTION**—Use of controls or adjustments or performance of procedures other than those specified herein may result in hazardous radiation exposure.



**WARNING**—This product, when properly installed and operated, is considered a Class I laser product. Class I products are not considered to be hazardous.

**There are no user serviceable parts located inside the cover of this device.**

**Do not attempt to remove the cover of this product. Failure to comply with this instruction could cause accidental exposure to laser radiation.**

# Table of Contents

<b>1. Setup</b> .....	<b>5</b>
1.1. Unpacking .....	5
1.2. Layout .....	8
1.3. Default Settings .....	10
1.4. Initial Operation .....	10
<b>2. User Interface</b> .....	<b>11</b>
<b>3. Operation</b> .....	<b>11</b>
3.1. Power Up .....	11
3.2. Printer Operation .....	12
3.3. Operate Screen .....	13
3.3.1. Favorites .....	13
3.3.2. Sampling .....	13
3.3.3. Sample Status .....	14
3.3.4. Sample History .....	14
3.3.5. Warnings / Errors .....	14
3.4. Sample Related Functions .....	15
3.4.1. Starting/Stopping .....	15
3.4.2. Real-Time Output .....	15
3.4.3. Sample Mode .....	15
3.4.4. Sample Time .....	15
3.4.5. Hold Time .....	15
3.4.6. Sample Timing .....	15
<b>4. Main Menu</b> .....	<b>16</b>
4.1. Edit Main Menu Items .....	17
4.2. Sample Setup Screen .....	17
4.2.1. Location Number .....	17
4.2.2. Sample Time .....	17
4.2.3. Hold Time .....	17
4.2.4. Samples .....	18
4.3. Settings Screen .....	18
4.3.1. Count Units .....	18
4.3.2. Temperature .....	18
4.4. Serial Screen .....	18
4.4.1. Report Type .....	18
4.4.2. Baud Rate .....	19
4.4.3. Serial Output Mode .....	19
4.4.4. Flow Control .....	19
4.5. Printer Screen .....	19
4.5.1. Printer .....	19
4.6. Favorites Screen .....	20
4.6.1. Favorites Mode (ON/OFF) .....	20
4.6.2. Favorites Sizes (SIZE) .....	20
4.6.3. Favorites Alarm Limits (ALARM) .....	20
4.6.4. Favorites Analog Output Scaling (A-SCALE) .....	20

4.7.	Calibrate Flow Screen .....	21
4.8.	Set Sizes Screen .....	21
4.9.	Set Clock Screen .....	21
4.10.	Set Contrast Screen .....	22
4.11.	Password Screen .....	22
4.12.	About Screen .....	23
<b>5.</b>	<b>Data Menu .....</b>	<b>23</b>
5.1.	Copy to USB Drive .....	23
5.2.	Recall Data .....	24
5.3.	Printing Sample Data.....	24
5.4.	Memory Screen .....	25
5.4.1.	View Available Memory.....	25
5.4.2.	Clearing memory.....	25
<b>6.</b>	<b>Charging the Battery.....</b>	<b>26</b>
6.1.	Battery Replacement .....	26
6.1.1.	To charge the replacement battery pack .....	26
6.1.2.	To replace the battery pack .....	26
<b>7.</b>	<b>Serial Communications .....</b>	<b>28</b>
7.1.	Commands .....	28
7.1.1.	Computer Mode .....	28
7.1.2.	User Mode.....	28
7.2.	Real Time Output .....	29
7.3.	Comma Separated Value (CSV) .....	29
7.4.	Printer Style .....	30
7.5.	RS485 Networking.....	31
7.6.	MODBUS Communication.....	32
7.6.1.	Remaining Sample Time.....	32
7.6.2.	Real Time Counter (6) Readings .....	32
7.6.3.	Operational State .....	32
7.6.4.	Laser Operating Current .....	32
7.6.5.	Laser Runtime.....	32
7.6.6.	Pump Runtime .....	33
7.6.7.	Real Time Temperature .....	33
7.6.8.	Real Time Pressure .....	33
7.6.9.	Previous Sample Time Stamp .....	33
7.6.10.	Previous Counter Readings .....	33
7.6.11.	Error Conditions .....	33
7.6.12.	Real Time RH.....	33
7.7.	Ethernet Port Setup and Configuration .....	34
7.7.1.	Setting the Static IP Address of the BT-620: .....	34
7.7.2.	Web Page Configuration .....	35
7.7.3.	Installing the Virtual Serial Port Drivers: .....	37
7.7.4.	Configuring the Virtual Com Port for the BT-620: .....	38
<b>8.</b>	<b>Maintenance .....</b>	<b>42</b>

8.1. Service Schedule.....	42
8.1.1. Zero Count Test .....	42
8.1.2. Flow Rate Test .....	42
8.1.3. Annual Calibration.....	43
8.2. Flash Upgrade .....	43
<b>9. Troubleshooting.....</b>	<b>43</b>
<b>10. Specifications.....</b>	<b>44</b>
<b>11. Warranty / Service .....</b>	<b>45</b>

## Introduction

The BT-620 is a portable airborne particle counter with a small stable footprint. This allows you to move it around and set it down rather than holding it in your hand while sampling. The large character backlit LCD display provides easy viewing from distances exceeding 3 meters.

Other key features include:

- 6 particle sizes (Defaults: 0.3, 0.5, 1.0, 2.0, 5.0 and 10  $\mu\text{m}$ )
- User size settings (0.1 $\mu\text{m}$  steps from 0.3 to 2 $\mu\text{m}$ , 0.5 $\mu\text{m}$  steps from 2 to 10 $\mu\text{m}$ )
- 2 Favorite sizes (including count alarm limits and analog output)
- Copy data to USB memory stick
- On Board Printer
- Serial communications (Ethernet, USB, RS232, RS485)
- Internal battery pack for portable operation.

## 1. Setup

The following sections cover unpacking, layout and performing a test run to verify operation.

### 1.1. Unpacking

**When unpacking the BT-620 and accessories, inspect the carton for obvious damage. If the carton is damaged notify the carrier. Unpack and inspect the contents of the shipping container.**

The BT-620 is shipped with the standard items shown in Figure 1. Contact the supplier if any items are missing. Figure 2 shows optional equipment which can be purchased separately.

**Iso-Kinetic Inlet**



**PN: 81752**

**BT-620**



**Zero Filter**



**PN: 81754**

**Manual**



**PN: BT-620-9800**

**Battery Charger**



**PN: 81751**

**Particle View  
Software USB**



**Calibration  
Certificate**



**USB Cable**



**PN: 500784**

**Comet Software**



**Printer Paper**



**PN: 750514**

**Figure 1 – Standard Equipment**

## BT-620 Optional Equipment

### Temperature & Humidity Probe



PN: G3120

### Flow Meter



PN: SWIFT 6.0

### Flow Meter



PN: 81755

### Serial Cable



PN: 550065

### Replacement Battery Pack



PN: 81769

### Battery Charger Cable



PN: 81770

Figure 2 – Optional Equipment



## 1.2. Layout

Figure 3 shows the layout of the BT-620 and the following table provides a description of the components.





Power Switch



Charger Jack



RS-232

USB I/O

RS 485

Analog Out

Ethernet

Figure 3 – BT-620 Layout

Component	Description
Display	4X20 character LCD display (backlit)
Keyboard	8 key membrane keypad
Printer	On Board thermal printer
Power Switch	Switch that turns the BT-620 on or off (up for on).
Charger Jack	Input jack for the battery charger. This jack charges the internal battery pack and provides continuous operating power for the unit.
Inlet Nozzle	Ambient air inlet nozzle. Connect isokinetic probe to reduce turbulence in the air sample.
T/RH Connector	Mating connector for the optional external Temperature/RH sensor.
USB I/O	USB communication port
USB Flash Drive	Export sample data to USB memory stick
RS-232 Serial Port	Connection used for serial communication
RS-485 Serial Port	Connection used for long distances (4,000 feet) or multi-drop (32 units)
Ethernet Port	Ethernet connection
Analog out	Two analog output channels (0-5V = 0 – FS Counts). FS (Full Scale) is settable from 0 to 9,999,999 counts.

### 1.3. Default Settings

The BT-620 comes with the user settings configured as follows.

Parameter	Value
Sample Location	1
Sample Mode	Single
Sample Time	60 seconds
Sample Hold Time	0 seconds
Count Units	CF
Temperature Units	C
Baud Rate	9600
Serial Output	RS-232

### 1.4. Initial Operation

Before operating the BT-620 for the first time, it is recommended that the unit be fully charged. Information regarding battery charging is found in Section 0. Complete the following steps to verify proper operation.







1. Press the top of the power switch to turn on power.
2. Observe the Startup Screen for 2 seconds then the Operate Screen (Section 3.2)
3. Press Start / Stop key. The BT-620 will sample for 1 minute and stop.

4. Observe the counts on the display
5. Use the up / down arrows to view other sizes
6. The unit is ready for use.

## 2. User Interface

The BT-620 user interface is composed of an 8 button keypad and a LCD display. The following table describes keypad functionality.

Note: Some keys have more than one function.

Key	Description
	<ul style="list-style-type: none"> <li>• Starts or stops a sample (Operate or Main Menu Screen).</li> <li>• Starts USB data transfer (Copy to USB Drive Screen).</li> <li>• Starts printing data (Print Data Screen).</li> <li>• Recalls the selected data (Recall Data Screen).</li> </ul>
	<ul style="list-style-type: none"> <li>• Loads the Data Menu Screen.</li> </ul>
	<ul style="list-style-type: none"> <li>• Loads the Main Menu Screen.</li> <li>• Loads the Operate Screen when in the Main Menu Screen.</li> <li>• Cancel editing. Returns the field to the original value before editing began.</li> </ul>
	<ul style="list-style-type: none"> <li>• Loads the screen associated with menu item.</li> <li>• View history when Operate Screen is displayed.</li> <li>• Stops editing a field and saves the changed value.</li> </ul>
	<ul style="list-style-type: none"> <li>• Navigates up / down when not editing.</li> <li>• Modifies field when editing.</li> </ul>
	<ul style="list-style-type: none"> <li>• Navigates left / right</li> </ul>

## 3. Operation

The following sections cover the basic operation.

### 3.1. Power Up

The BT-620 power is controlled by a switch located on the back of the unit. To power up the unit move the switch to the on position (up).

The first screen shown on power up is the Startup Screen (Figure 4). This screen displays the product type and company website for approximately 2 seconds before loading the Operate Screen.

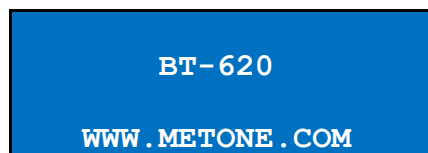

**Figure 4 – Startup Screen**

### 3.2. Printer Operation



**Figure 5 – Open Printer Door**

If there is no paper loaded in the printer, the indicator light on the bottom right of the printer will glow orange. To load paper into the printer, lift the printer door latch from the center until the door opens.



**Figure 6 – Install Paper and Close Printer Door**

Place a roll of paper in the printer bay with the free end up and coming from the back of the roll. Close the printer door and the green indicator light should light. Press the white button on the printer to manually advance the paper. See Section 4.4.4 for Printer Operation.

### 3.3. Operate Screen

The Operate Screen displays the date/time, sample status, current sample data and previous sample data. Figure 7 shows the Operate Screen.

15	AUG' 10	11:23	L001
0.3 $\mu$		0	CF
0.5 $\mu$		0	CF
0.7 $\mu$		0	CF
1.0 $\mu$		0	CF
2.0 $\mu$		0	CF
5.0 $\mu$		0	CF

Figure 7 – Operate Screen

The top line of the Operate Screen is reserved for the normal header (date, time and location) or status/alarm messages depending upon the machine status. The top line remains stationary while the other 3 lines scroll to display the full list. Temp/RH data will follow the count data when the RH/Temp probe is connected.

The Operate Screen normally displays 6 particle sizes; however, the BT-620 also offers a Favorites mode which configures the unit to display and print any two of the six standard sizes (see Section 3.3.1).

Particle counts units are user selectable. The selections include: Total counts (TC), particles per liter (/L), particles per cubic foot (CF) and particles per cubic meter (M3). Ambient temperature can be displayed in units of Celsius (C) or Fahrenheit (F). Both unit settings are discussed in Section 4.2.4.

#### 3.3.1. Favorites

The Favorites setting eliminates the need to scroll the display when monitoring two non-adjacent sizes (see Section 4.4). The Favorites setting configures the display and printer for two sizes however the BT-620 still counts and buffers all six particle sizes. Sample data for all six channels is available via the serial port (Section 0) or by viewing count history on the display (Section 3.3.4). Figure 8 shows the Favorites Operate Screen with RH/Temp probe attached.

18	AUG' 06	11:23	L001
0.3 $\mu$		0	CF
5.0 $\mu$		0	CF
Temp	24°C	RH	40 %

Figure 8 – Favorites Operate Screen w/ RH/Temp

#### 3.3.2. Sampling

The Operate Screen displays current sample information when the unit is sampling (real time data). Concentration values (/L, CF, M3) are time dependent so these values may fluctuate early in the sample; however, after several seconds the measurement will

stabilize. Longer samples (e.g. 60 seconds) will improve concentration measurement accuracy. Figure 9 shows the Operate Screen while sampling with RH/Temp probe attached.

COUNTING...	58	L001
0.3μ	29,780	CF
0.5μ	1,400	CF
TEMP	24°C RH	40%

Figure 9 – Operate Screen (Sampling)

### 3.3.3. Sample Status

The top line of the Operate Screen displays the status of the BT-620 while the unit is sampling. The following table shows the various status messages and their meaning:

Status	Description
STARTING...	Starting the sample and waiting for the count system to initialize.
COUNTING... 58	BT-620 is sampling. The time remaining is displayed to the far right.
HOLDING...10	BT-620 is in auto mode and is waiting for the hold time to finish. The time remaining is displayed to the far right.

### 3.3.4. Sample History

Sample history (previous data) can be viewed on the Operate Screen when the unit is stopped (not sampling). To view sample history, press the Enter key from the Operate Screen. The unit will display the last sample event (newest record) and display “←” on the right side of the display (see Figure 10) to indicate history data. Press ◀ or ▶ to move through sample history one record at a time (◀ displays older events, ▶ displays newer events). Press the Enter key at any time to return to the Operate Screen. Press Start at any time to start a new sample.

Sample history will display 2 channels in Favorites mode. To view other channels, change favorite sizes or disable Favorites mode (Section 4.4) before you view history.

15 AUG' 10 11:23	L001
0.3μ	0 CF ←
0.5μ	0 CF ←
0.7μ	0 CF ←

Figure 10 – History Screen

### 3.3.5. Warnings / Errors

The BT-620 displays warning/error messages on the top line of the Operate Screen. These messages alternate with the normal date/time header. The following table lists the warning/error messages:

Display Message	Description
<COUNT ALARM>	Count alarm. The count is $\geq$ the alarm limit.
LOW BATTERY!	Low battery warning. Less than 15 minutes of normal operation remaining. Recharge the battery
FLOW ERROR!	The sample flow rate is not within $\pm 10\%$ of the nominal 1 CFM flow rate.
SENSOR ERROR!	Particle sensor error.

### 3.4. Sample Related Functions

The following sub-sections cover BT-620 sample related functions.

#### 3.4.1. Starting/Stopping

To start or stop a sample, press the START/STOP key. A sample event can be manually started or stopped from either the Operate Screen or the main menu.

#### 3.4.2. Real-Time Output

BT-620 provides real-time output on the serial port at the end of each sample. The format of the output is controlled by the Serial Output setting (Section 4.4).

#### 3.4.3. Sample Mode

The sample mode controls single sample or continuous sampling. The Single setting configures the unit for a single sample. The Repeat setting configures the unit for continuous sampling. Enter number of samples to sample n samples and stop.

#### 3.4.4. Sample Time

The sample time determines the amount of time that counts are accumulated. The length of the sample is user settable from 1 – 9999 seconds and is discussed in section 4.2.2.

#### 3.4.5. Hold Time

The hold time is used when the sample mode is set to repeat (continuous sample) or number of samples mode. The hold time represents the time from the completion of the last sample to the start of the next sample. The hold time is user settable from 0 – 9999 seconds and is discussed in section 4.2.3.

#### 3.4.6. Sample Timing

The following figures depict the sample timing sequence for both single and repeat sampling modes. Figure 11 shows the timing for single sample mode. Figure 12 shows the timing for repeat sample mode.



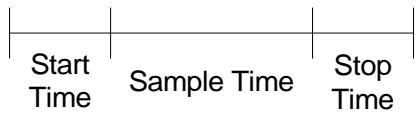

**Figure 11 – Single Mode Sample**



**Figure 12 – Repeat Mode Sample**

## 4. Main Menu

The Main Menu is accessible by pressing the menu key on the Operate Screen. The table below shows the Main Menu items. Press ▲ or ▼ to navigate to a menu item then press Enter to display a screen where you can view or change item setting(s).

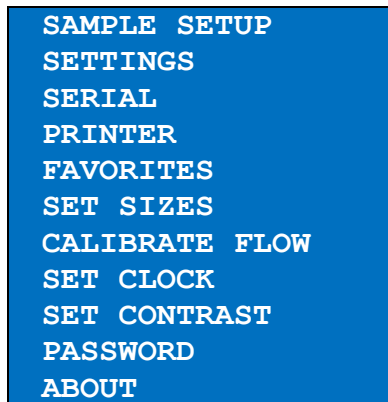

**Figure 13 – BT-620 Main Menu**

Menu Item	Description	Press Enter to navigate to...
SAMPLE SETUP	View / change location number, auto / Single mode, sample time and hold time.	Sample Setup Screen
SETTINGS	View / change volume (count units) and temperature units °C / °F.	Settings Screen
SERIAL	View / change Serial Report type, Baud Rate, serial mode and Flow Control.	Serial Screen
PRINTER	View / change Printer enable setting	Printer Screen
FAVORITES	Set count alarm limits for 2 particle sizes	Count Alarm Screen
SET SIZES	Set particle sizes	Set Sizes Screen
CALIBRATE FLOW	Calibrate the sample flow rate	Flow Screen
SET CLOCK	Set the date and time.	Set Clock Screen
SET CONTRAST	Adjust the display contrast.	Set Contrast Screen
PASSWORD	View/Set the user password.	Password Screen
ABOUT	Display firmware version and serial number.	About Screen

## 4.1. Edit Main Menu Items

To change settings, press Menu to display the Main Menu, press ▲ or ▼ to navigate to the desired item and press Enter to display the item view/edit screen.

To edit pick list items (e.g. Sample Setup - Single/Repeat), press ▲ or ▼ to navigate to the item. Press Enter to select the item. Press ▲ or ▼ to change the setting. Press ENTER to save the setting or ESC to cancel and return to the main value.

To edit numeric values (e.g. Count Alarms - Alarm Limit), press ▲ or ▼ to navigate to the item. Press Enter to select the item. Press ▲ or ▼ to increment or decrement a value. Press ◀ or ▶ to select the next digit. Press ENTER to save the value or ESC to cancel and return to the original value.

**Note:** If the user password is set, the user password must be entered to gain access to the main menu.

## 4.2. Sample Setup Screen

Figure 14 shows the Sample Setup Screen. The 4 parameters are covered in the following sections.

LOCATION:	001
SAMPLE TIME:	060
HOLD TIME:	000
SAMPLES:	SINGLE

Figure 14 – Sample Setup Screen

### 4.2.1. Location Number

The location number is used to assign a unique number to a location or area. This important field is included in sample data records (display, printer and serial output).

### 4.2.2. Sample Time

The sample time determines the amount of time that counts are accumulated while the pump is running. The length of the sample is user settable from 1 – 9999 seconds.

### 4.2.3. Hold Time

The Hold time is the time between samples when sampling in Repeat mode (continuous) or number of samples mode. The Hold time is user settable from 0 – 9999 seconds. The pump will remain on during the hold period if the Hold time is 60 seconds or less. The pump will stop after each sample, and start a few seconds before the next sample, if the Hold time is greater than 60 seconds. Hold times greater than 60 seconds will increase pump life.

#### 4.2.4. Samples

The samples setting controls the number of samples to take as illustrated below.

Selection	Description
REPEAT	Repeat configures the unit for continuous sampling.
SINGLE	Single configures the unit for a single sample.
002-9999	Configures the unit to take N samples.

#### 4.3. Settings Screen

Figure 15 shows the Settings Screen. The 4 parameters are covered in the sections immediately following.

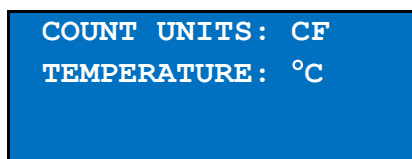

Figure 15 – Settings Screen

##### 4.3.1. Count Units

The BT-620 supports total counts (TC), particles per liter (/L), particles per cubic foot (CF) and particles per cubic meter (M3). Particle count information updates while the unit is sampling. Concentration values (/L, CF, M3) are time dependent so these values may fluctuate early in the sample; however, after several seconds the measurement will stabilize. Longer samples (e.g. 60 seconds) will improve concentration measurement accuracy.

##### 4.3.2. Temperature

The BT-620 displays temperature in Celsius (C) or Fahrenheit (F).

#### 4.4. Serial Screen

Figure 16 – Serial Screen shows the Serial Screen. The 4 parameters are covered in the sections immediately following.

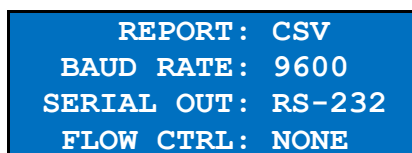

Figure 16 – Serial Screen

##### 4.4.1. Report Type

The Report setting determines the output format for the Serial Port. The choices are NONE, CSV and PRINTER.

When set to NONE, the unit will not automatically output the reading at the end of a sample to the Serial Port. CSV is a Comma Separated Values output format suitable for importing into a spreadsheet. PRINTER is the same format as the screen and panel mounted printer.

This setting does not affect the panel mounted printer which always prints in PRINTER format.

#### 4.4.2. Baud Rate

Use the Baud Rate selection to set the serial communications baud rate. BT-620 communicates at baud rates from 300 – 115200.

#### 4.4.3. Serial Output Mode

The Serial Out setting controls the behavior of the BT-620 serial output. The modes are RS232, RS485, Printer or Network (see Section 0 for serial communication protocol). The following table lists the Serial Output settings and describes their meanings.

Serial Out Setting	Description
RS232	RS232/USB communication.
RS485	RS485 communication.
NETWORK	RS485 communication with all serial output suppressed unless specifically addressed.

#### 4.4.4. Flow Control

The Flow Control setting is set to NONE for most standard RS-232 / USB serial port applications. This setting can be set to RTS/CTS for hardware handshaking when using the Ethernet port. The baud rate and flow control settings must also be set to match in the Netburner Ethernet card setup for Ethernet connection.

### 4.5. Printer Screen

Figure 17 shows the Printer Screen.

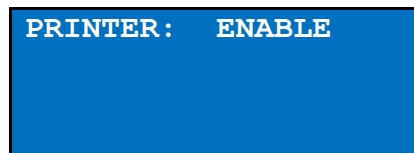

Figure 17 – Printer Screen

#### 4.5.1. Printer

The Printer setting selects whether to ENABLE or DISABLE the panel mounted printer for automatic output at the end of each sample. The panel mounted printer always prints in Printer format regardless of the Serial Output format specified.

## 4.6. Favorites Screen

The Favorites mode eliminates the need to scroll the display when monitoring two non-adjacent sizes. The Favorites mode also provides count alarm limits and analog output scaling for the Favorites (2 count channels). The Favorites mode controls the display (real time and history) and printer format. The CSV serial output includes all 6 sizes. Figure 18 – Favorites shows the Favorites screen.

FAVORITES ON		
SIZE	ALARM	A-SCALE
0.3	0500000	0500000
5.0	0500000	0500000

Figure 18 – Favorites

### 4.6.1. Favorites Mode (ON/OFF)

Enables or disables Favorites mode (On = Enabled, Off = Disabled).

### 4.6.2. Favorites Sizes (SIZE)

Select 2 of the 6 standard or custom sizes. Favorite 1 is 0.3  $\mu\text{m}$  in Figure 18 (above).

### 4.6.3. Favorites Alarm Limits (ALARM)

Favorites count alarm limit. A zero (0) value disables the count alarm. The alarm is active when the count is equal to or greater than the alarm limit. The maximum alarm limit value is 9,999,999.

Alarm values do not change with the count units setting (TC, /L, CF, M3). In other words, a value of 1,000 will alarm at 1,000 counts or 1,000 particles per cubic foot or 1,000 particles per liter depending on the count unit setting.

### 4.6.4. Favorites Analog Output Scaling (A-SCALE)

Favorites analog output scaling (0 – 5 volts = 0 – VALUE). The maximum scale value is 9,999,999. A zero (0) value will configure the analog output for a digital or binary alarm (0 volts = normal, 5 volts = alarm). The alarm limit for this binary mode is configured in Section 4.6.3 above.

Figure 19 shows the analog output connector pin assignments. G pins are signal ground. 1 and 2 are Analog Output 1 and Analog Output 2 which are associated with Favorite 1 and Favorite 2 respectively (see Section 4.6.2).



Figure 19 – Analog Output Connector

#### 4.7. Calibrate Flow Screen

The BT-620 has a factory calibrated flow rate of 1 CFM (28.3 LPM). Under normal circumstances, the integrated flow control system will maintain flow within +/- 5% of this flow rate. Use the following procedure to calibrate the flow rate when a periodic flow rate check (Section 8.1.2) indicates a flow rate error greater than +/- 5%.

1. Connect a reference flow meter to the inlet fitting on the top of the unit.
2. Access the Calibrate Flow screen by pressing Menu then select Calibrate Flow. The pump will start automatically when you enter the Calibrate Flow screen and stop when you leave the screen. The system will wait several seconds for the flow to stabilize. During this time, the unit will display "Waiting..."
3. Afterwards, use the up and down arrow keys to adjust the flow until the reference flow meter reads within tolerance. You will need to wait a few seconds after each adjustment for the flow system and the reference meter to stabilize. Figure 20 shows an example of the Calibrate Flow Screen.
4. When the desired flow rate is reached, press ENTER to set the calibration.
5. Exit the Calibrate Flow screen by pressing the ESC button (the pump will stop).

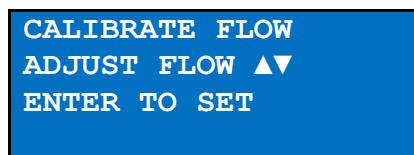
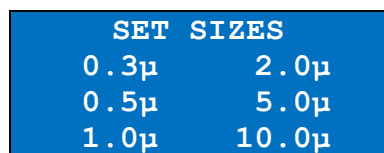

Figure 20 – Calibrate Flow

#### 4.8. Set Sizes Screen

The BT-620 has six standard factory calibrated particle sizes. These standard sizes will support most applications and provide the best size accuracy (+/- 10%). This unit also supports custom sizes. These sizes are configured using the Set Sizes Screen (Figure 21). Custom size thresholds are interpolated using the standard size calibration curve. Therefore, the size accuracy for custom sizes is somewhat reduced (+/- 15%).



SET SIZES	
0.3μ	2.0μ
0.5μ	5.0μ
1.0μ	10.0μ

Figure 21 – Set Sizes Screen

The unit sorts sizes from small to large after each size change. Duplicate sizes are not allowed. Any attempt to set two or more sizes to the same value will result in a "DUPLICATE SIZES!" warning message.

#### 4.9. Set Clock Screen

To set the date and time select SET CLOCK from the menu. Figure 22 shows the Set Clock Screen and the following table describes the date and time formats.

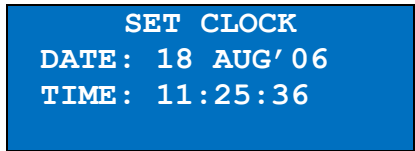
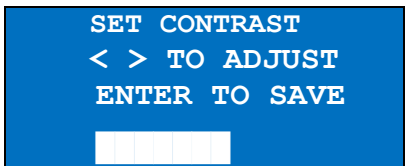

**Figure 22 – Set Clock Screen**

Date / Time Formats		
Date	dd mmm'yy	dd=day, mmm=month, yy=year
Time	hh:mm:ss	Hh=hours, mm=minutes, ss=seconds

#### 4.10. Set Contrast Screen

Press ◀ or ▶ to improve display quality. Press Enter to save the setting or ESC to cancel the change. Figure 23 shows the Set Contrast Screen.



**Figure 23 – Set Contrast**

#### 4.11. Password Screen

The user settings in the BT-620 can be password protected to prevent unauthorized access. This helps maintain the integrity of the data.

The PASSWORD setup screen is used to set, change, or remove the 4-digit numeric password that is used to restrict access to these areas including the setup menu. The default password is 0000. This disables the password and allows unrestricted access to all the password-controlled functionality.

If the password is changed to any value between 0001 and 9999, it will subsequently be required for access to these screens.

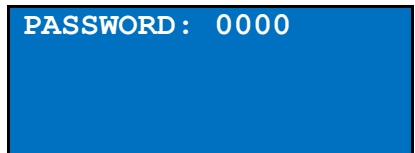

**Figure 24 – Password Screen**

## 4.12. About Screen

Figure 25 shows the About Screen. The About Screen shows the firmware version and programmable logic version on the second line. Press ▲ or ▼ to toggle between the two version numbers. The serial number is shown on the third line.

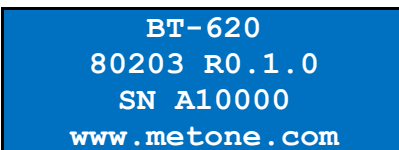

```
BT-620
80203 R0.1.0
SN A10000
www.metone.com
```

Figure 25 – About Screen

## 5. Data Menu

To access data options (copy data, view available memory, recall data and print data), simply press the Data key to navigate to the Data Screen. Figure 26 shows the Data Screen.

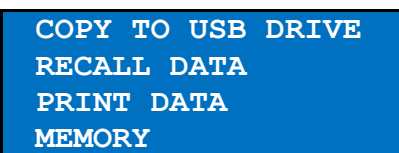

```
COPY TO USB DRIVE
RECALL DATA
PRINT DATA
MEMORY
```

Figure 26 – Data Screen

### 5.1. Copy to USB Drive

Figure 27 shows the Copy Data Screen. The BT-620 will copy all data from the displayed date/time to current time. Initially, the date/time will be the first sample record so all records will be copied. To reduce transfer time, press Enter and change the date/time to a more recent date/time.

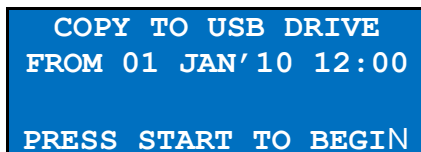

```
COPY TO USB DRIVE
FROM 01 JAN'10 12:00
PRESS START TO BEGIN
```

Figure 27 – Print Data Screen

Press the Start button to initiate the copy process. Press the ESC button to cancel the copy process and return to the Data menu. The following screen is displayed during the copy process (Figure 28).

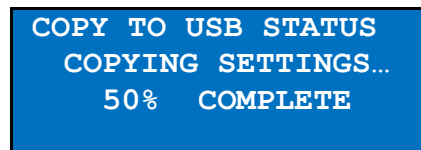

```
COPY TO USB STATUS
COPYING SETTINGS...
50% COMPLETE
```

Figure 28 – USB Status Screen



## 5.2. Recall Data

Stored sample events can be viewed from the Operate Screen but this requires navigating one record at a time to reach a desired record. The Recall Data Screen provides a way to quickly navigate to a record based on time. Figure 29 shows the Recall Data Screen.

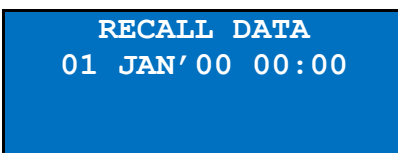

Figure 29 – Recall Data Screen

To recall data, enter the desired date/time and select the START/STOP button. The unit will recall the data from the date/time entered (if an exact match is found) or the next most recent data available. The unit will display “←” on the right side of the display to indicate history data.

## 5.3. Printing Sample Data

Stored sample events can be printed via the serial port within a user selected range. To access the printing feature, press the Data key then select PRINT DATA from the menu. Figure 30 shows the Print Data Screen.

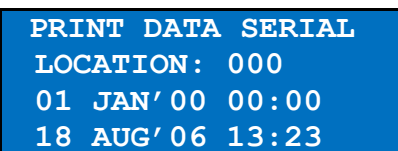

Figure 30 – Print Data Screen

This screen allows the user to choose whether the output goes to the panel mounted printer or the serial port. The panel mounted printer always prints in PRINTER output format. The output format for the serial port is selected in the Serial Screen.

Edit the location and time range to select which sample events to print. The following table describes the settings.

Setting	Description
PRINT DATA	Pick SERIAL or PRINTER for where to send the output.
LOCATION	The location ID of the sample events to print. Setting location to 000 prints all locations. Settable from 0 - 999
01 JAN'00	The date/time to begin printing sample events from.
18 AUG'06	The date/time to stop print samples.

After the print settings have been selected, press the Start button to display the status screen. Figure 31 shows the Printing Status Screen as it would look when finished.

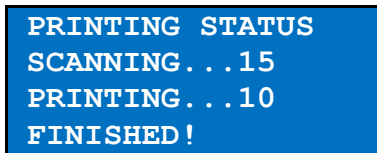

A blue rectangular screen with white text. The text is centered and reads: PRINTING STATUS, SCANNING . . . 15, PRINTING . . . 10, and FINISHED!

**Figure 31 – Printing Status Screen**

Pressing the ESC button cancels the data printing and loads the menu. The format of the print is dependent upon the report setting (Section 4.2.4).

## **5.4. Memory Screen**

The BT-620 memory is composed of a single file which contains the data from sample events. Every time a sample is completed, the BT-620 stores that data into the memory. The BT-620 memory is circular, meaning when the memory is full, the unit will start overwriting the oldest saved samples with new samples. BT-620 provides the user the ability to view the memory usage as well as clear the memory.

### **5.4.1. View Available Memory**

Memory Screen is used to view available memory or to clear the memory. The Memory Screen is accessed by selecting MEMORY from the Data Menu. Figure 32 shows the Memory Screen.

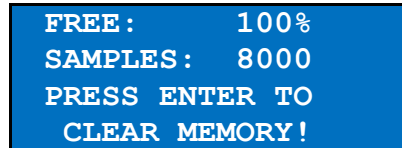

A blue rectangular screen with white text. The text is centered and reads: FREE : 100%, SAMPLES : 8000, PRESS ENTER TO, and CLEAR MEMORY!

**Figure 32 – Memory Screen**

FREE shows the percent of space available for data storage. When 0% is displayed, memory is full and the oldest data will be overwritten by new data. SAMPLES shows the number of samples which can be store in memory before the memory is full. When 0% is displayed, memory is full and the oldest data will be overwritten by new data.

### **5.4.2. Clearing memory**

To clear memory, press the ENTER key while viewing the Memory Screen. This will delete all the sample events in memory. A warning screen will be displayed to prevent accidental erasure.

## 6. Charging the Battery

### **Caution:**

**The provided battery charger is designed to work safely with this device. Do not attempt to connect any other charger or adapter to this device. Doing so may result in equipment damage.**

To charge the battery, connect the battery charger to an AC power outlet and the DC plug to the socket on the back of the BT-620. The battery charger is universal and will work with power line voltages of 100 to 240 volts, 50 to 60 Hz. The battery charger LED will be Red during charging Phase 1 (constant current). It will turn Orange during Phase 2 (constant voltage). At this point, the battery is 80-95% charged. The LED will turn Green 4 hours after Phase 2 begins.

*Note: The battery pack will generally be fully charged 3 hours after charging begins. At this point, the LED will still be Orange.*

When fully charged the battery inside the BT-620 will power the unit for about 4 hours of continuous sampling. Under normal operation, the battery will power the unit for about 8 hours. For continuous operation, operate the unit with the battery charger attached. Charge the battery before storing the BT-620. Storing a discharged battery will degrade its performance.

### 6.1. Battery Replacement

You can purchase an optional battery charging cable and replacement battery pack to extend battery operating time. Use the charging cable with the included battery charger to charge the replacement battery while you operate the BT-620 under battery power.

#### 6.1.1. To charge the replacement battery pack

1. Connect the battery charging cable to the battery charger
2. Connect the replacement battery to the charging cable
3. Connect the battery charger to the AC outlet
4. The battery charger LED will be Red during charging Phase 1 (constant current). It will turn Orange during Phase 2 (constant voltage). At this point, the battery is 80-95% charged. The LED will turn Green 4 hours after Phase 2 begins.

*Note: The battery pack will generally be fully charged 3 hours after charging begins. At this point, the LED will still be Orange.*

#### 6.1.2. To replace the battery pack

1. Turn BT-620 power off
2. Remove all rear panel connections (battery charger, serial communication).
3. Tip BT-620 back on rear panel feet (*Photo #1 below*).
4. Loosen screw holding battery door (#2).
5. Remove the battery door (#3 & #4).
6. Remove the battery pack (#5).
7. Disconnect battery pack (#6).
8. Connect replacement battery pack (#6).
9. Tuck the wires in carefully as you replace the battery pack (#5 & #4).
10. Replace the battery door (#3).

11. Tighten the battery door screw (#2).
12. Return the BT-620 to the upright position.



(#1)



(#2)



(#3)



(#4)



(#5)



(#6)

## 7. Serial Communications

BT-620 provides serial communications via USB, DB9, RJ45 and terminal block connectors located on the back of the unit. The following sections discuss the various serial communications.

### **ATTENTION:**

The USB driver **must** be installed before connecting the BT-620 USB port to your computer. If the supplied drivers are not installed first, Windows may install generic drivers that are not compatible with this product.

Driver download weblink: <https://metone.com/usb-drivers/>

Met One Instruments, Inc. also provides the Comet software utility for extracting information (data, alarms, settings, etc.) from Met One Instruments products. The software is designed for the user to easily access information within a product without having to know underlying communications protocol for that device.

The Comet program is available for download from the Met One Instruments website: <https://metone.com/products/comet/>

### 7.1. Commands

The BT-620 provides serial commands for accessing stored data and settings. All commands are terminated by a carriage return. Also, these commands are not case sensitive. The following table lists the available commands. These commands are available via USB, RS232 and RS485 hardware interfaces. The settings (baud rate, parity and stop bits) must match the computer setting for proper communication regardless of the hardware interface type (USB, RS232 or RS485).

#### 7.1.1. Computer Mode

Computer Mode is intended for connecting the unit directly to a data logger or computer program such as Comet. This is the default mode of the unit.

In Computer Mode, all commands are preceded by the <Esc> (ASCII 27) character. No characters are echoed back to the user when entering commands. All commands are executed using the <ENTER> key.

Each time the <Esc> key is pressed, the unit will reset to Computer Mode and start the command input over.

#### 7.1.2. User Mode

User Mode is intended for direct user interaction. In User Mode, all incoming characters are echoed back to the user.

The user can wake the unit into User Mode by sending 3 <CR> (Enter Key) characters within 3 seconds. This prompt character “\*” will be displayed when the unit is in Terminal Mode.

The unit will return to Computer Mode after 2 minutes of inactivity on the serial port. The Q command will return the unit immediately to Computer Mode.

<b>Settings (must match computer settings):</b>	
<ul style="list-style-type: none"> <li>• Baud Rate = Selectable (see Section 4.2.4)</li> <li>• Parity = None</li> <li>• Stop Bits = 1</li> </ul>	
<b>Command</b>	<b>Description</b>
?,H	Displays the help menu
1	Returns the units settings information
2	Returns all available records from the data file
3	Returns all records since last '2' or '3' command.
4	Returns the last n records
D	Date (mm/dd/YY)
T	Time (HH:MM)
C	Clear data
S	Start a sample
E	End a sample
ST	Sample Time
RV	Show software revision.
ID	Set/Get the Location ID. Range 1-999.
FAX	Favorites alarm limit setting where x=1 or 2 for Alarm 1 or 2.
FSx	Favorites size setting where x=1 or 2 for Alarm Size 1 or 2 respectively.
SF	Favorites mode. 0=Off, 1=On
SH	Hold Time in seconds
SN	Sample Number of Samples (0=Repeat)
SR	Set Report Mode (0=None, 1=CSV, 2=Printer)
SS	Read serial number
CU	Count Units (0=CF, 1=/L, 2=TC, 3=M3)
TU	Temperature Units (0=C, 1=F)
RZ	Returns Channel Size information.
DT	Sets Date/Time without user interaction (string)
OP	Operational Status. S=Stop, R=Running, H=Hold.
CS	Set Channel Sizes (all 6 Channel Sizes)

## 7.2. Real Time Output

The real time output occurs when the unit finishes a sample. The output format is either a comma separated value (CSV) or a printer style depending on the Serial Report mode.

## 7.3. Comma Separated Value (CSV)

The CSV output fields are both comma separated and fixed length.

### **CSV Header (Note 1):**

Time,Size1,Count1(M3),Size2,Count2(M3),Size3,Count3(M3),Size4,Count4(M3),Size5,Count5(M3),Size6,Count6(M3),AT(C),RH(%),Location,Seconds,Fav1Size,Fav2Size,Status

### **CSV Example Record:**

2013-09-30

10:04:05,00.3,08562345,00.5,01867184,00.7,00654892,01.0,00245849,02.0,00055104,05.0,0031790,+023,040,001,010,00.3,00.5,000,\*00086

CSV Fields			
Field	Parameter	Example Value	Notes
1	Date and Time	2013-09-30 10:04:05	
2	Channel 1 Size	0.3	
3	Channel 1 Count (TC, /L, CF, M3)	8562345	Note 2
4	Channel 2 Size	0.5	
5	Channel 2 Count (TC, /L, CF, M3)	1867184	Note 2
6	Channel 3 Size	0.7	
7	Channel 3 Count (TC, /L, CF, M3)	654892	Note 2
8	Channel 4 Size	1.0	
9	Channel 4 Count (TC, /L, CF, M3)	245849	Note 2
10	Channel 5 Size	2.0	
11	Channel 5 Count (TC, /L, CF, M3)	55104	Note 2
12	Channel 6 Size	5.0	
13	Channel 6 Count (TC, /L, CF, M3)	31790	Note 2
14	Temperature (C,F)	23	Note 2 & Note 3
15	RH (%)	40	Note 3
16	Location	1	
17	Sample Time (0-9999 seconds)	60	
18	Favorite 1 Size	0.3	Note 4
19	Favorite 2 Size	0.5	Note 4
20	Status Bits (see below)	0	Note 5

Status Bits		
Bit	Value	Condition
	0	OK (no alarms/errors)
0	1	Count alarm size 1
1	2	Count alarm size 2
2	4	Not used
3	8	Not used
4	16	Low battery
5	32	Sensor error
6	64	Not used
7	128	Not used

Notes (for table above):
1. CSV header included for multiple record transfers like All Data (2) or New Data (3). The CSV header does not print in Computer or Network mode.
2. Units determined by product setting.
3. Temperature and RH will be spaces ( , , ) if Temp/RH probe is not attached.
4. Favorite sizes will be spaces ( , , ) if alarms are disabled.
5. Status bit combinations are possible. For example, 17 (00010001B) = Low Battery and Size 1 alarm.

#### 7.4. Printer Style

The printer output format is 9 lines by 26 characters (including T/RH if attached).

## 7.5. RS485 Networking

The unit can be configured to operate in a Multi-Drop RS485 network using the Serial Out setting on the Settings Screen. The unit will also automatically be set to network mode if it detects network commands being sent to any device in the network.

When the unit is in network mode, it will not echo any characters or respond to any commands unless specifically addressed. The network address is the same as the Location ID set in the Sample Setup screen. It is important that no two units have the same Location ID set in the same network.

When in network mode, the unit is considered to be under Remote Control and key operating parameters cannot be changed by a local operator. These settings are: Sample Mode, Sample Time, Hold Time, Count Units and Temperature Units. The operator can still set the Serial Out to return the unit to Local Control. The Location can also be set to change the network address if necessary.

Figure 33 shows the RS485 connector location and pin assignments. Figure 34 shows a RS-485 network wiring diagram.



Figure 33 – RS485 Connector

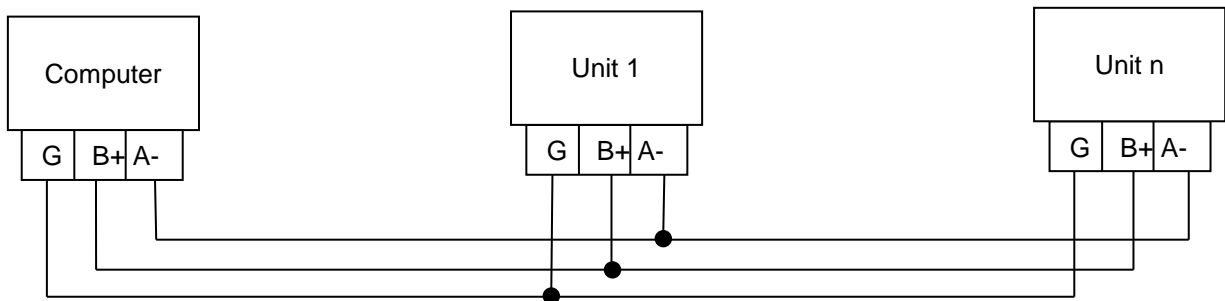

Figure 34 – RS485 Network



## 7.6. MODBUS Communication

The BT-620 supports MODBUS communications protocol. The serial transmission is RTU mode. The following data type abbreviations are used in the 3x register descriptions.

Data Type	Abbreviation
16-bit Unsigned Integer	Word
32-bit Unsigned Integer	DWord
32 bit Floating Point	Float

The following Modbus 3x registers are used to access various readings.

3x type registers are accessed using the function code Read Input Registers (04).

### 7.6.1. Remaining Sample Time

Description	Data Type	Register(s)
This register returns the remaining sample time in 25 mSec ticks. (40 ticks / Second)	DWord	2064 - 2065

### 7.6.2. Real Time Counter (6) Readings

Description	Data Type	Register(s)
Real time Channel 1 counter value. These registers report the real time count during a sample cycle.	DWord	2066 - 2067
Real time Channel 2 counter value.	DWord	2068 - 2069
Real time Channel 3 counter value.	DWord	2070 - 2071
Real time Channel 4 counter value.	DWord	2072 - 2073
Real time Channel 5 counter value.	DWord	2074 - 2075
Real time Channel 6 counter value.	DWord	2076 - 2077

### 7.6.3. Operational State

Description	Data Type	Register(s)
This register returns the Operational status of the counter operation—None (0), Start (1), Starting (2), Counting (3), Stop (4).	Word	2082

### 7.6.4. Laser Operating Current

Description	Data Type	Register(s)
This register returns the real time Laser Operating current in mA.	Float	2084 - 2085

### 7.6.5. Laser Runtime

Description	Data Type	Register(s)
This register returns the real time total laser runtime in seconds. This value is stored to the EE every 60 seconds.	DWord	2088 - 2089

### 7.6.6. Pump Runtime

Description	Data Type	Register(s)
This register returns the real time total pump runtime in seconds. This value is stored to the EE every 60 seconds.	DWord	2090 - 2091

### 7.6.7. Real Time Temperature

Description	Data Type	Register(s)
This register returns the real time temperature reading in C. If the external Temp/RH sensor is installed	Float	2094 - 2095

### 7.6.8. Real Time Pressure

Description	Data Type	Register(s)
This register returns the real time pressure reading in Pa.	Float	2096 - 2097

### 7.6.9. Previous Sample Time Stamp

Description	Data Type	Register(s)
Previous sample time stamp in seconds. This value is updated at the end of each sample cycle.	DWord	2100 - 2101

### 7.6.10. Previous Counter Readings

Description	Data Type	Register(s)
Previous sample Channel 1 counter value. These values are updated at the end of each sample cycle.	DWord	2102 - 2103
Previous sample Channel 2 counter value.	DWord	2104 - 2105
Previous sample Channel 3 counter value.	DWord	2106 - 2107
Previous sample Channel 4 counter value.	DWord	2108 - 2109
Previous sample Channel 5 counter value.	DWord	2110 - 2111
Previous sample Channel 6 counter value.	DWord	2112 - 2113

### 7.6.11. Error Conditions

Description	Data Type	Register(s)
Error condition register All bits clear = Status OK Bit 0 set = Non-Volatile Memory fail Bit 1 set = Laser Calibration fail Bit 2 set = Vacuum Pump fail Bit 3 set = Air Filter fail Bit 4 set = Temperature sensor fail Bit 5 set = Pressure sensor fail	Word	2120

### 7.6.12. Real Time RH

Description	Data Type	Register(s)
This register returns the real time RH reading in %. If the external Temp/RH sensor is installed	Float	2122 - 2123

## 7.7. Ethernet Port Setup and Configuration

The BT-620 Ethernet port must be configured with some drivers by the user:

### 7.7.1. Setting the Static IP Address of the BT-620:

1. You will need to obtain a Static IP Address from your network administrator.
2. Turn on BT-620. Set baud rate to 38400 in the SETUP menu.
3. Connect CAT5 Ethernet cable between local network and Ethernet connector on the back of the BT-620.
4. Download the Ethernet Utilities from <https://metone.com/software/> . Right click on the Ethernet Drivers and Utilities zip folder and select Extract All.
5. Click on the IPSetup Application. The following screen will appear:

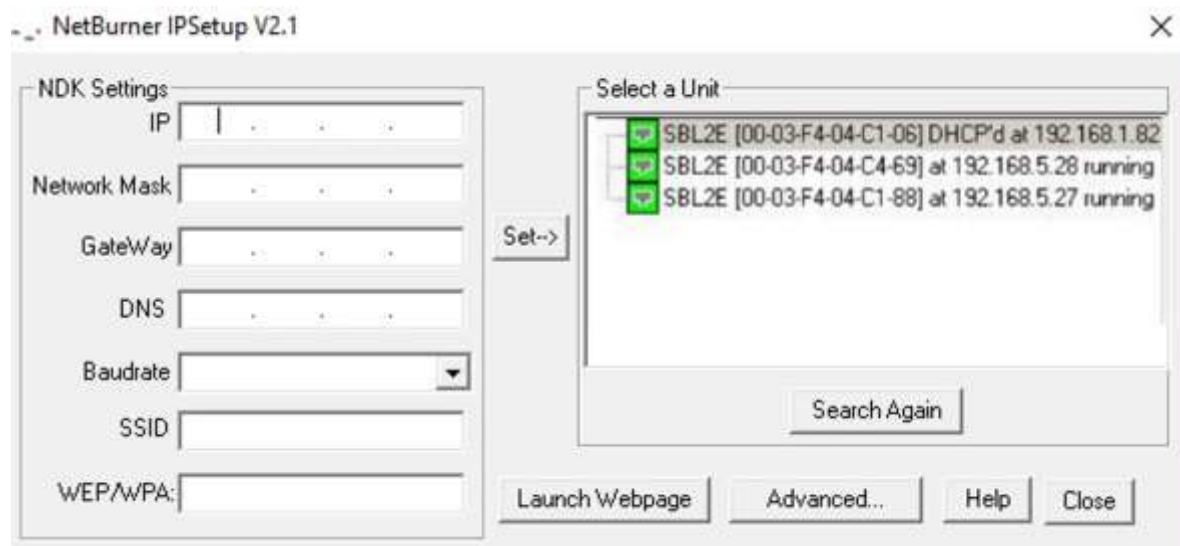

6. Click on the “Select a Unit” line that shows a DHCP’d in the title.
7. Type in your static IP address in the IP window. Be sure to write this number down as you will need it later.
8. Type in a Network Mask in the Network Mask window.
9. Set the baud rate to 38400.
10. Press the Set button to change the IP address of the BT-620.
11. Click the Launch Webpage button to open a browser for webpage configuration.
12. Click the X close button.

## 7.7.2. Web Page Configuration

1. Open a web browser and enter the numeric IP Address in the address field if Launch Webpage was not selected in IPSetup. The first section of the Network Configuration page is used to select DHCP or static IP addressing.
  - a. If you select DHCP, and you have a DHCP server on your network, the DHCP assigned values will be displayed. To select a static IP address change the Address Mode to Static, and enter your values in the Static Settings fields.



[Network](#) | [Serial](#) | [GPIO](#) | [Password](#)

### Network

Device Name (for DHCP)

Addressing Mode

**IP SETTINGS:**

	Static Settings	DHCP Values
Device IP Address	<input type="text" value="0.0.0.0"/>	10.1.1.185
Device Subnet Mask	<input type="text" value="0.0.0.0"/>	255.255.255.0
Device Gateway	<input type="text" value="0.0.0.0"/>	10.1.1.1
DNS Server	<input type="text" value="0.0.0.0"/>	66.75.160.15
Ethernet Link	<input type="button" value="Normal"/>	Physical power cycle required after change

- b. The incoming connection section configures a device server mode to listen for incoming TCP connections for each serial port.

	Port 0	Port 1
<b>INCOMING CONNECTIONS:</b>		
Listen for incoming network connections	<input checked="" type="checkbox"/>	<input checked="" type="checkbox"/>
Listening network port:	<input type="text" value="23"/>	<input type="text" value="24"/>
Timeout and disconnect after this many seconds of inactivity.	<input type="text" value="30"/>	<input type="text" value="30"/>
Allow new connection if the existing connection has been idle for this many seconds.	<input type="text" value="30"/>	<input type="text" value="30"/>

- c. Outgoing connections (client mode)

<b>OUTGOING CONNECTIONS:</b>		
Make outgoing connections:	<input type="button" value="Never"/>	<input type="button" value="Never"/>
Connect on network port:	<input type="text" value="1000"/>	<input type="text" value="1000"/>
Connect/Send to this address:	<input type="text" value="0.0.0.0"/>	<input type="text" value="0.0.0.0"/>
Timeout and disconnect after this many seconds of inactivity.	<input type="text" value="60"/>	<input type="text" value="60"/>
Retry failed outgoing connections after this many seconds.	<input type="text" value="60"/>	<input type="text" value="60"/>

- d. Custom packetization can apply to TCP and UDP communication.

CUSTOM PACKETIZATION:			
Enable custom packetization logic	<input type="checkbox"/>		<input type="checkbox"/>
Use UDP instead of TCP	<input type="checkbox"/>		<input checked="" type="checkbox"/>
Learn UDP reply Address	<input type="checkbox"/>		<input checked="" type="checkbox"/>
Number of characters to accumulate before sending TCP/UDP packet(128Max):	<input type="text" value="50"/>		<input type="text" value="50"/>
Number msec to wait for accumulated characters: 0 waits forever.	<input type="text" value="100"/>		<input type="text" value="100"/>
Flush TCP/UDP frame when this character is received (Enter NA to disable):	<input type="text" value="NA"/>		<input type="text" value="NA"/>

2. Click on the Serial link at the top of the page to configure the serial settings of the device. Change the Baud Rate and Flow Control settings to match your BT-620. All other settings should remain as shown. Press the Submit New Settings button to have these settings take effect. In some slower networks, characters may be dropped. If this happens, set the Flow Control to “RTS/CTS” both here and on the BT-620 Serial Screen (Section 4.4). When in doubt, set the Flow Control to RTS/CTS when using Ethernet communications.



[Network](#) | [Serial](#) | [GPIO](#) | [Password](#)

Serial	Port 0	Port 1
Data Port Settings (If both are DEBUG, defaults to Port 0):	DEBUG ▾	RS-232 ▾
Data Baud Rate:	115200 ▾	115200 ▾
Data Bits:	8 ▾	8 ▾
Data Parity:	None ▾	None ▾
Stop Bits:	1 ▾	1 ▾
Flow Control:	None ▾	None ▾
<input type="button" value="Submit New Settings"/>		

3. Detailed explanations for web page configuration can be found in the SBL2eUsersManual downloaded with the Ethernet Drivers and Utilities.

### 7.7.3. Installing the Virtual Serial Port Drivers:

A virtual COM Port allows users to designate a COM port for their existing Ethernet setup for a Met One Instruments, Inc. device. This is not necessary to be able to talk to the device, this just creates an alternative method for connecting to your device if TCP/IP is not an option for some software applications.

1. From the extracted folder, run the VirtualCommPort-2.1 application. The Choose Destination screen will appear as shown below. Click on the Next button. Select your operating system and click Next. The Start Installation screen will appear. Click Next. The Installing screen will display that the software is installing the drivers.

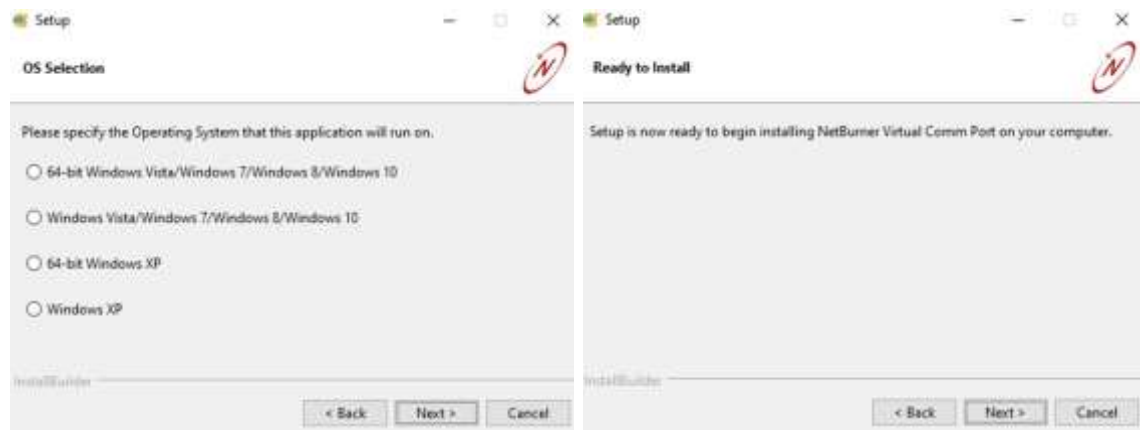
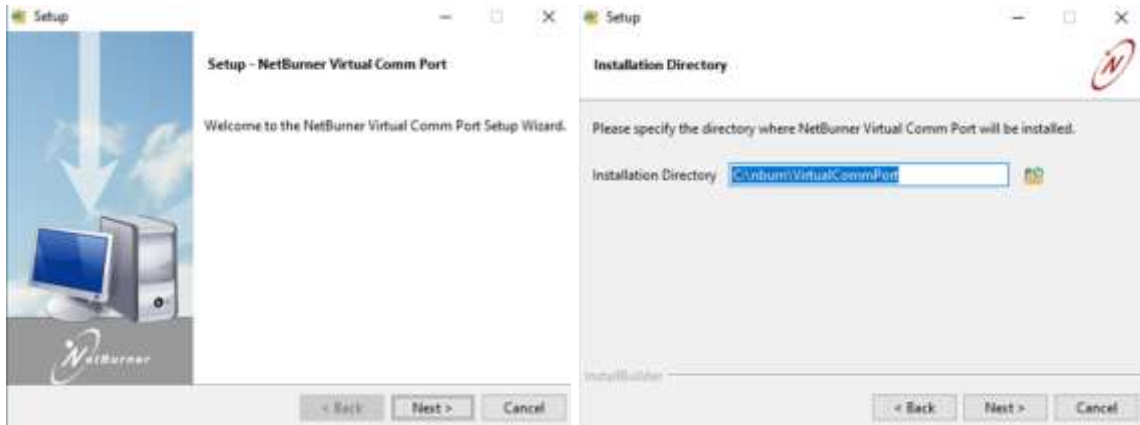

2. When the Installation Complete screen is displayed, click the Finish button. You will need to restart your computer before the drivers will be ready to use.

#### 7.7.4. Configuring the Virtual Com Port for the BT-620:

1. Open your My Computer folder and navigate to the C:\nburn\VirtualCommPort folder. Double click the NBVirtualCommPort application file:

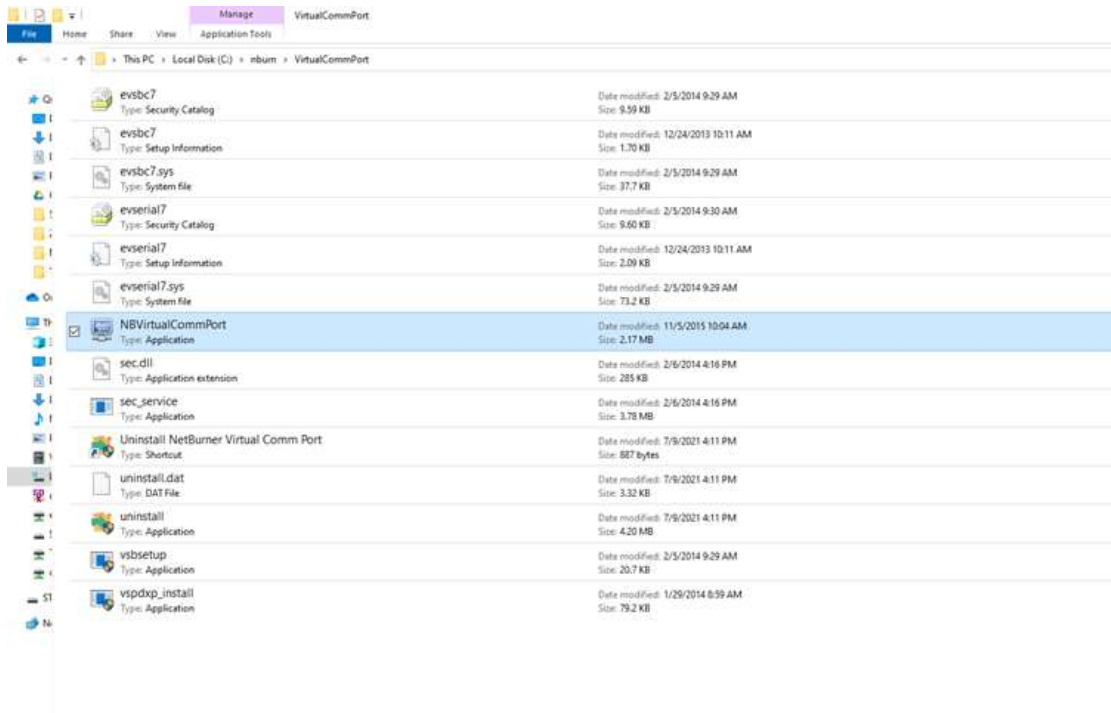

2. The configuration window will appear as shown below. Click the Add button.



3. Select Client connection for the connection type.

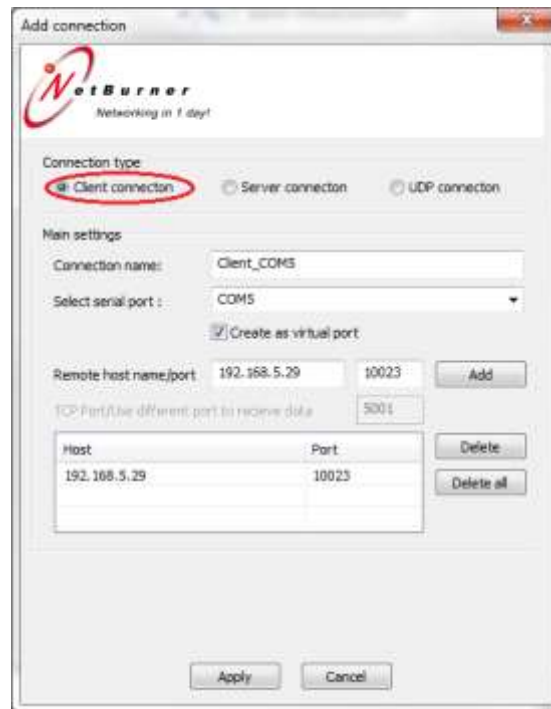

4. Under Select serial port, choose the COM port you would like to assign to your device.





5. Under Connection name, enter a descriptive name for this virtual com port.

The screenshot shows the 'Add connection' dialog box in NetBurner. The 'Connection type' is set to 'Client connection'. Under 'Main settings', the 'Connection name' field is highlighted with a red oval and contains 'Client\_COM5'. The 'Select serial port' dropdown is set to 'COM5'. The 'Create as virtual port' checkbox is checked. The 'Remote host name/port' section shows '192.168.5.29' and '10023' with an 'Add' button. Below this, the 'TCP Port/Use different port to receive data' is set to '5001'. A table lists the host and port: 192.168.5.29 and 10023. There are 'Delete' and 'Delete all' buttons. At the bottom are 'Apply' and 'Cancel' buttons.

Host	Port
192.168.5.29	10023

6. Make sure "Create as virtual port" is checked.

The screenshot shows the 'Add connection' dialog box in NetBurner. The 'Connection name' field contains 'Client\_COM5'. The 'Select serial port' dropdown is set to 'COM5'. The 'Create as virtual port' checkbox is highlighted with a red oval and is checked. The 'Remote host name/port' section shows '192.168.5.29' and '10023' with an 'Add' button. Below this, the 'TCP Port/Use different port to receive data' is set to '5001'. A table lists the host and port: 192.168.5.29 and 10023. There are 'Delete' and 'Delete all' buttons. At the bottom are 'Apply' and 'Cancel' buttons.

Host	Port
192.168.5.29	10023

7. Enter the Static IP address and port number into the Remote host name/port section. Click the Add button to add this TCP/IP address, then the Apply button to add this virtual COM port.



8. Now the setting should be displayed on the main page of the program. Use the refresh button on the right hand side to refresh the status of the virtual port. As seen in the image below, it found the settings to be 38400 baud, no parity, 8 databits, and 1 stopping bit. After talking to the device, it was able to refresh and see the amount of data sent/received.



## 8. Maintenance

Due to the nature of the instrument, there are no customer serviceable components in the BT-620. The case of the BT-620 should never be removed or opened for any reason. **Opening or removing the case of the BT-620 voids the warranty and may result in exposure to laser radiation, which can cause eye injury.**

### 8.1. Service Schedule

Although there are no customer serviceable components in the BT-620, there are service items which ensure the proper operation of the instrument. Table 1 shows the service schedule for the BT-620.

Time Period	Item	Manual Section
Weekly	Zero Count Test	8.1.1
Monthly	Flow Rate Test	8.1.2
Yearly	Annual Calibration	8.1.3

**Table 1 Service Schedule**

#### 8.1.1. Zero Count Test

Air leaks or debris in the particle sensor can cause false counts which may result in significant count errors when sampling clean environments. Perform the following zero count test weekly to ensure proper operation:

1. Attach the zero count filter to the inlet nozzle (P/N 81754).
2. Configure the unit as follows: Sample Mode = Single, Sample Time = 60 seconds, Volume = Total Count (TC)
3. Start and complete a sample.
4. The smallest particle size should have a count  $\leq 1$ .

#### 8.1.2. Flow Rate Test

The flow rate test verifies the sample flow rate is within tolerance. The reference flow meter must be non-loading because the vacuum pump can be loaded down by external restrictions. Met One Instruments sells a suitable flow meter (P/N 81755). The flow rate test follows:

1. Connect a  $\pm 3\%$  reference flow meter to the sample inlet nozzle.
2. Start a 5 minute sample.
3. The flow meter reading after ~3 minutes should be 1 CFM (28.3 LPM)  $\pm 5\%$ .
4. The flow rate can be adjusted using the front panel (see Section 4.7)

### 8.1.3. Annual Calibration

The BT-620 should be sent back to Met One Instruments yearly for calibration and inspection. The annual calibration cannot be performed by the customer because this calibration requires specialized equipment and a skilled technician. Met One Instruments maintains a calibration facility for calibrating particle counters according to industry accepted methods such as ISO, JIS and NIST. The annual calibration also includes inspection and preventative maintenance to improve product reliability.

### 8.2. Flash Upgrade

BT-620 is firmware upgradeable via the serial connection using a Met One Instruments flash burn program. Binary files and the flash program must be provided by Met One Instruments.

## 9. Troubleshooting

The following section covers some common failure symptoms, causes and solutions. It is important to note that there are no customer serviceable components in this product. The BT-620 case should never be removed or opened for any reason. **Opening or removing the case will void the warranty and may result in exposure to laser radiation, which can cause eye injury.**

Symptom	Possible Cause	Solution
Display does not turn on	<ul style="list-style-type: none"><li>• Low Battery</li><li>• Defective Battery</li></ul>	<ul style="list-style-type: none"><li>• Charge battery</li><li>• Send to service center</li></ul>
Pump does not turn on when a sample is started	<ul style="list-style-type: none"><li>• Low Battery</li><li>• Defective pump</li></ul>	<ul style="list-style-type: none"><li>• Charge battery</li><li>• Send to service center</li></ul>
Keypad does not work	<ul style="list-style-type: none"><li>• Loose connector</li><li>• Internal hardware failure</li></ul>	<ul style="list-style-type: none"><li>• Send to service center</li></ul>
Printer does not print	<ul style="list-style-type: none"><li>• Printer not enabled</li><li>• Paper not installed</li><li>• Paper not fed properly</li></ul>	<ul style="list-style-type: none"><li>• Enable printer</li><li>• Install paper</li><li>• Open printer door, re-position paper</li></ul>
Sample result is lower than normal	<ul style="list-style-type: none"><li>• Flow rate is low</li><li>• Optics may be contaminated</li></ul>	<ul style="list-style-type: none"><li>• Perform flow rate test</li><li>• Send to service center</li></ul>
Sample result is higher than normal	<ul style="list-style-type: none"><li>• Flow rate is high</li><li>• Air leak in unit</li><li>• Optics may be contaminated</li></ul>	<ul style="list-style-type: none"><li>• Perform flow rate test</li><li>• Send to service center</li><li>• Send to service center</li></ul>
Battery does not hold a charge	<ul style="list-style-type: none"><li>• Defective or worn out battery</li><li>• Defective charger</li></ul>	<ul style="list-style-type: none"><li>• Send to service center</li></ul>

## 10. Specifications

### Performance

Particle Size Range	0.3µm - 10µm, 6 channels
Calibrated Sizes	0.3 µm, 0.5µm, 1.0µm, 2.0µm 5.0µm and 10µm
User Size Settings	0.1µm steps from 0.3µm - 2.0µm 0.5µm steps from 2.0µm - 10µm
Concentration Range	0 – 600,000 particles per cubic foot (over 20M particles/m <sup>3</sup> )
Accuracy	± 10% to calibration aerosol
Sensitivity	0.3 µm
Flow Rate	1 cfm (28.3 lpm)
Sample Time	Adjustable: 1 to 9999 seconds
Hold Time	Adjustable: 0 to 9999 seconds

### Electrical

Light Source	Laser Diode, 90mW, 780 nm
Power	14.8V Li-Ion self-contained battery pack
Battery Operation	Up to 8 hours typical use or 4 hours continuous use Full recharge approximately 3 hours.
AC Adapter/Charger	Li-Ion charger, 100 – 240 VAC to 16.8 VDC @ 3.5 A
Communications	USB, RS-232 or RS-485
Standards	Meets ISO 21501-4 and CE

### Interface

Display	20 character x 4 line LCD
Keyboard	8 key membrane type

### Physical

Height	10.1" (25.7 cm) With handle 11.6" (29.5 cm)
Width	8" (20.3 cm)
Depth	9.5" (24.1 cm)
Weight	13.9 lbs (6.3 kg)

### Environmental

Operating Temperature	0° C to +40° C
Storage Temperature	-20° C to +60° C

### Accessories

Supplied	Operation Manual	(PN BT-620-9800)
	USB Cable	(PN 500784)
	Comet Software	(PN 80248)
	Particle View Software	(PN Particle View)
	Battery Charger	(PN 81751)
	Iso-kinetic Sample Probe	(PN 81752)
	Zero Particulate Filter	(PN 81754)
	Printer Paper (2 Rolls)	(PN 750514)
Optional	RH & Temperature Probe	(PN G3120)
	Flow Meter	(PN 81755)
	Serial Cable	(PN 550065)
	ISO 21501-4 Calibration	(PN 80849)

## 11. Warranty / Service

### Warranty

The BT-620 is warranted against defects and workmanship for a period of two (2) years from the ship date.

Any product found to be defective during the warranty period will, at the option of Met One Instruments, Inc., be replaced or repaired. In no case shall the liability of Met One Instruments, Inc. exceed the purchase price of the product.

This warranty may not apply to products that have been subject to misuse, negligence, accident, acts of nature, or that have been altered or modified other than by Met One Instruments, Inc. Consumable items such as filters, bearings pumps and batteries are not covered under this warranty.

Other than the warranty set forth herein, there shall be no other warranties, whether expressed, implied or statutory, including warranties of fitness of merchantability.

### Service

Any product being returned to Met One Instruments, Inc. for service, repair or calibration, including items sent for warranty repair, must be assigned a return authorization (RA) number. Please call (541) 471-7111 or send an email to [service@metone.com](mailto:service@metone.com) requesting an RA number and shipping instructions.

All returns must be shipped to the factory, freight pre-paid. Met One Instruments, Inc. will pay the shipping charge to return the product to the end user after repair or replacement of an item covered by warranty.

All instruments sent to the factory for repair or calibration must be free of contamination resulting from sampling chemicals, biological matter, or radioactive materials. Any items received with such contamination will be disposed of and the customer will be billed a disposal fee.

Replacement parts or service/repair work performed by Met One Instruments, Inc. are warranted against defects in material and workmanship for a period of ninety (90) days from the date of shipment, under the same conditions as stated above.

REV 2011