



# BeamWatch AM User Notes



## For Sales, Service or Technical Support

Phone: (435) 753-3729

Fax: (435) 753-5231

Service Email  
[service@us.ophiropt.com](mailto:service@us.ophiropt.com)

Sales Email  
[sales@us.ophiropt.com](mailto:sales@us.ophiropt.com)

Ophir-Spiricon, LLC  
3050 North 300 West  
North Logan, Utah 84341

©2020 Ophir-Spiricon, LLC



Dear Ophir-Spiricon Customer,

Thank you for your recent purchase of the BeamWatch AM system.

At Ophir-Spiricon we strive to provide the highest level of leading edge photonic measurement technology and service possible. We hope that your experience with us is a pleasant one, and anticipate the relationship we build will serve your photonic measurement needs for years to come.

As a valued customer, your comments and opinions are always very important to us. If you have any concerns, questions, or comments, bring them to our service department's attention. We are ready to help with everything from basic setup to working with you to find solutions for your most complex photonics measurement needs.

Please let us know if there is any way we can be of service. Thank you once again for your business.

Sincerely,

Ophir-Spiricon, LLC

Ophir-Spiricon, LLC  
3050 North 300 West  
North Logan, UT 84341, USA  
Tel 435-753-3729  
Fax 435-755-5231  
[www.ophiropt.com/photonics](http://www.ophiropt.com/photonics)

# How to Use this Guide

## Symbol Notation



Indicates general information that poses no risk.



Indicates important information about the product with little or no risk.



Indicates warning information. Failure to follow instruction may result in harm to the user or product damage.

# Safety

While the BeamWatch AM alone does not present the user with any safety hazards, this instrument is intended for use with laser systems. Therefore, the user should be protected from any hazards that the laser system may present. The greatest hazards associated with laser systems are damage to the eyes and skin due to laser radiation.

## Optical Radiation Hazards



BeamWatch AM is designed for use with high power lasers and therefore safety precautions must be taken. Users must be protected against accidental exposure. Exposure to personnel other than the user must also be considered. Hazards include direct beam exposure and reflected radiation. Protective eye shields and clothing must be worn.

## Electrical Hazards



BeamWatch AM utilizes only low voltages, derived from the USB and camera power supplies. Thus there is little risk of electrical shock presented to the user.

When installing or removing any hardware from a PC, the power to the computer should always be disconnected.

The computer should always be operated with its covers in place and in accordance with its manufacturer's recommendations.

The computer should always be operated with a properly grounded AC power cord.

# Chapter 1 General Information

## 1.1 Introduction

BeamWatch AM is the next version in Ophir-Spiricon's family of non-interfering beam monitoring systems. Designed specifically for the additive manufacturing industry, BeamWatch AM sports a new compact design and provides real-time measurement of the beam at the working plane location. Measurement of the beam's caustic is taken by imaging the Rayleigh scatter of the beam from the side. A dust shutter is implemented to prevent contamination of internal components and can only be opened when the purge gas is flowing. A light trap and power sensor are also included in the design to fully contain and provide absolute power measurement of the beam.

BeamWatch AM provides simultaneous measurements of multiple profiles along the beam caustic in the camera field-of-view (FOV). Real-time measurements are performed at video rates. They include:

- waist (focus spot) width and location
- focal shift
- centroid
- $M^2$  or K
- divergence
- Beam Parameter Product
- Rayleigh length
- absolute power

Real-time performance also allows for measurement of dynamic focal shift during laser startup.

The technique is based on Rayleigh scattering of laser light by oxygen and nitrogen molecules in the air as the beam propagates. Measurement of this scattered light provides an equivalent slit scan of the laser beam in the direction of the view observed. The scattered light is measured using conventional CCD cameras and image capture systems.

BeamWatch AM has USB connectivity to Windows personal computers for data acquisition, analysis, and display.



*Make sure to save the BeamWatch AM Shipping case and key. This makes it easier to ship when the unit needs to be recalibrated.*

## 1.2 Equipment

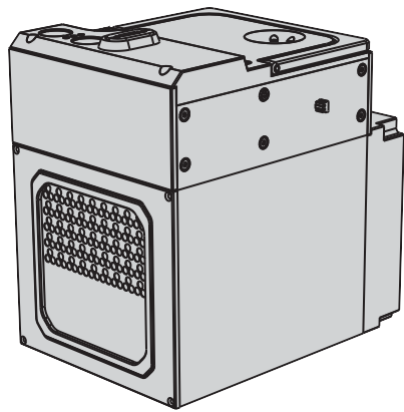

BeamWatch AM



User documentation:

- BeamWatch AM User Notes
- Alignment tool User Notes
- Calibration Certificate
- Quick Start Guide



Power Supply Cable

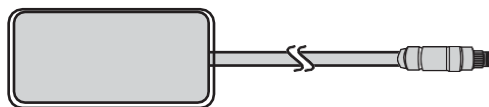

Power Supply Adapter

Software Installation  
Disc



Interlock Cable

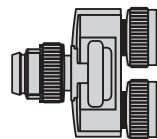

Y-Distributor for  
Interlock

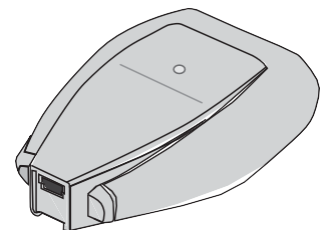

Juno USB Interface

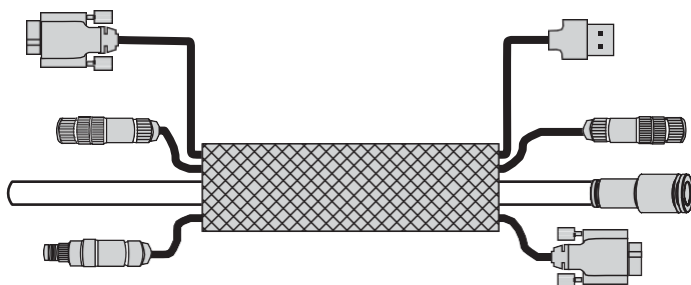

Wiring Harness:

- Power Sensor Cable
- Polyurethane Tubing
- Power Cable
- USB 3.0 Cable
- 5/32" - 1/4" Air Hose Adapter

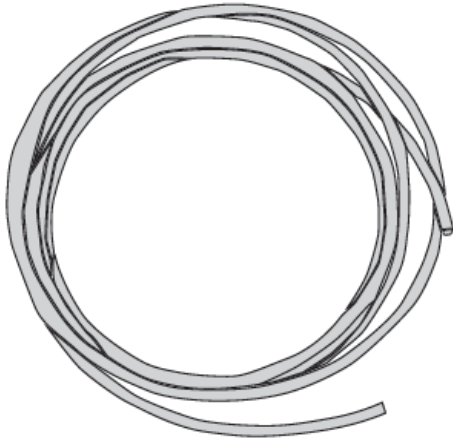

Additional 1/4" Air Hose  
(10ft)

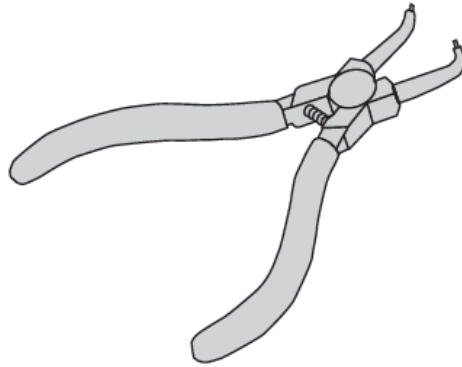

Retaining Ring Pliers

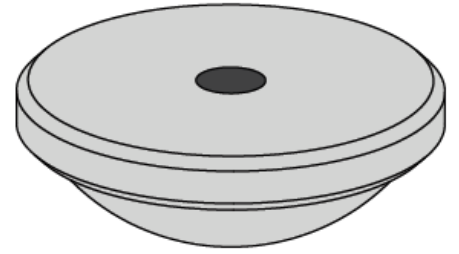

Halo Aperture

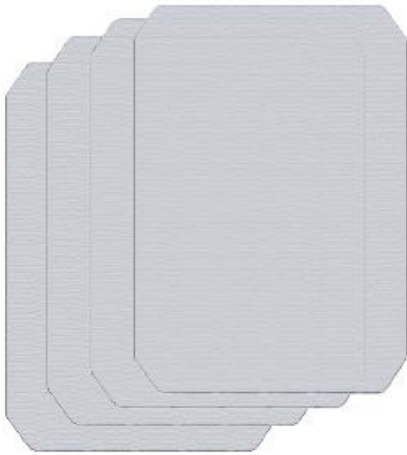

Replacement Filters  
(x4)

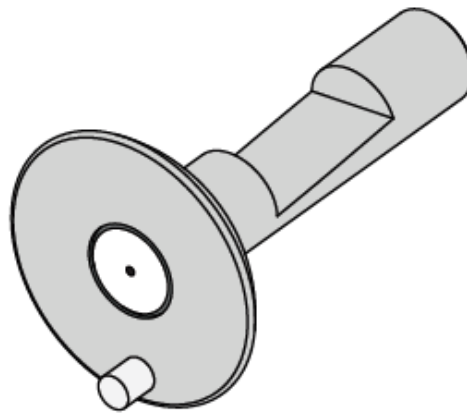

Alignment Tool

## 1.3 Getting to know BeamWatch AM

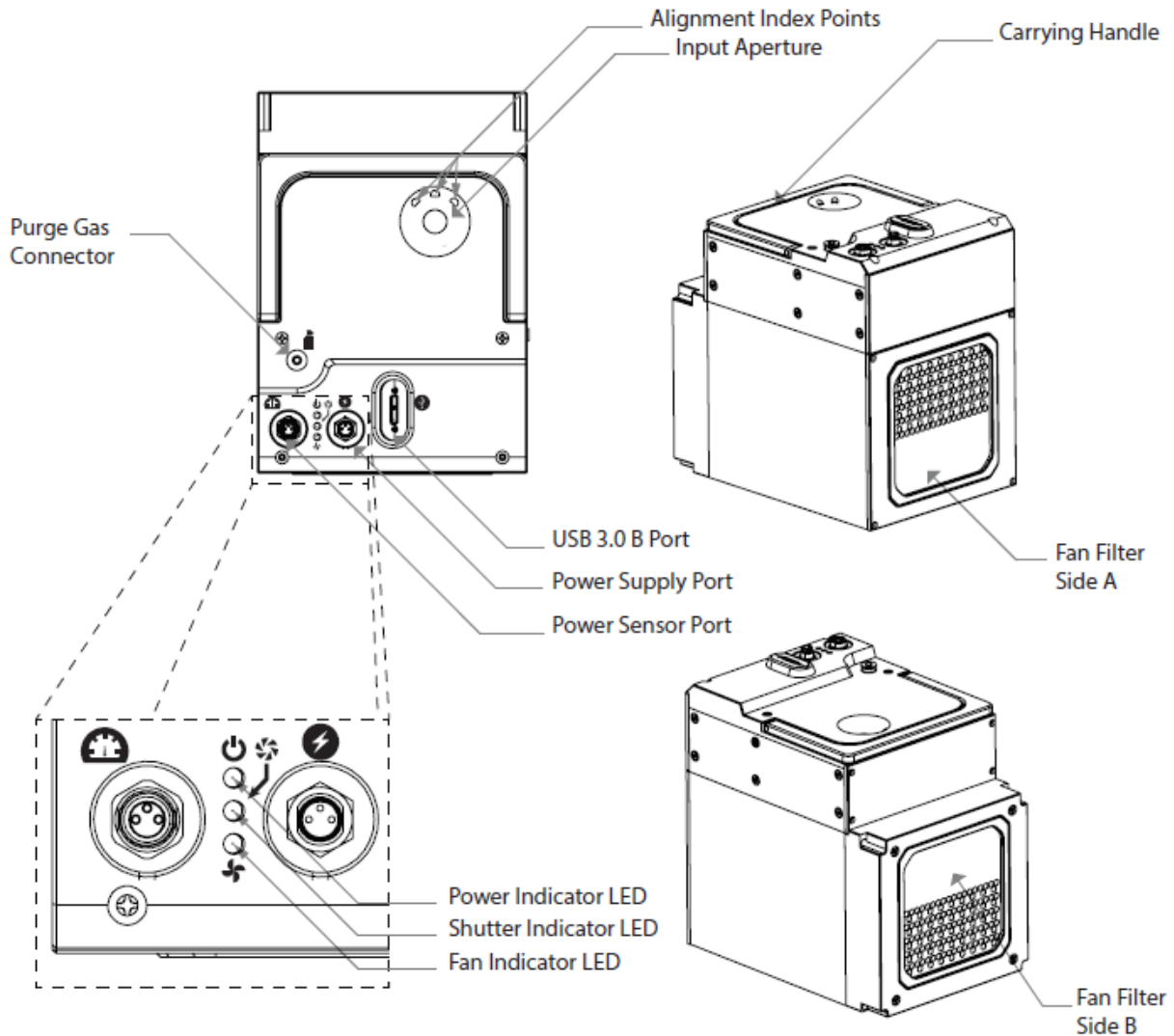

### 1.3.1 LED Notification Lights

Three LED lights on the top of the BeamWatch AM unit provide information at a glance about operation.

The Power Indicator LED shines green when the unit is receiving power.

The Shutter Indicator LED shines green when the shutter is open and red when the shutter is closed. The shutter cannot open without the purge gas connected and flowing.

The Fan Indicator LED shines green when the fan is active and does not shine when the fan is inactive. The fan is the primary method of cooling when the unit gets too hot. When the unit gets too hot a warning appears in the software. The fan can only be turned on from the software.



*The shutter cannot be open when the fan is running and vice-versa.*



## 1.4 Specifications

<b>Beam Profiling</b>	
<b>Wavelength</b>	1060-1080 nm
<b>Minimum Power density</b>	1.5 Megawatts/cm <sup>2</sup>
<b>Minimum Focus Spot</b>	50 microns
<b>Maximum Beam diameter at entrance</b>	6 mm (4.5 mm using the Halo Aperture)
<b>Communication to PC</b>	USB 2.0 & USB 3.0
<b>Power</b>	100-240 Volts AC 50/60Hz
<b>Particulate Purge</b>	Clean dry gas, 3-8 SLPM (35-100 PSI / 250-650 kPa). 1/4" hose fitting included.
<b>Beam Divergence</b>	15-60 mrad
<b>Field of View</b>	11.26mm x 2.99mm

<b>Power Meter/Beam Dump</b>	
<b>Measured Power</b>	50 W to 1000 W
<b>Maximum Power Exposure</b>	1000 W for 2 minutes (120 kJ)
<b>Precision</b>	±3%
<b>Cool-down Time</b>	20 minutes with fan cooling if used to maximum exposure

<b>General</b>	
<b>Weight</b>	17 lbs
<b>Dimensions</b>	7.03in x 4.96in x 7.16in 178.57mm x 126mm x 181.92mm

## 1.5 Operating Space

The graphic below gives a visual indication of the recommended operating space for BeamWatch AM. If BeamWatch is operated outside of this space, it may be difficult to see the curvature of the caustic or the beam may be large enough at the edges of the image that it is out of focus.

- Best results yield the strongest measurements and may be ISO when 3 Rayleigh lengths can be seen by the camera's detector.
- Acceptable results do not meet ISO requirements, but can still be strong, accurate measurements.
- Avoid applying lasers that fall within the Danger Zone as these results may lead to damaging fine components in the BeamWatch AM unit.

### BeamWatch AM Operating Space

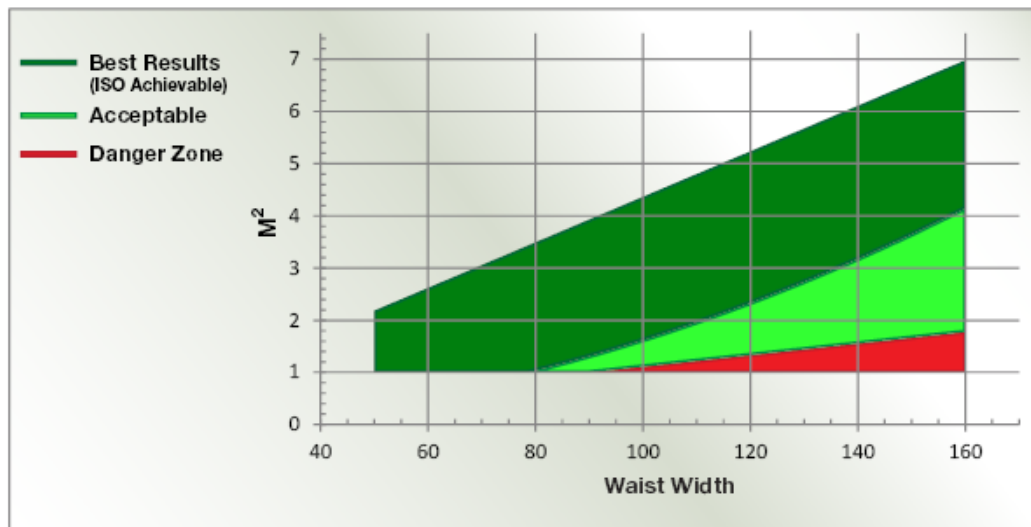

In some cases results may fall within the Best Results area of the plot, but not state ISO. If this occurs, the build plate location can be adjusted so the appropriate amount of Rayleigh lengths can be seen. Only make adjustments after following the standard setup procedure and achieving an initial understanding of the beam.

The calibrated distance is measured to the center of the FOV and the detector is approximately 11mm vertically. The build plane location can be adjusted  $\pm 5$ mm with the working plane still in the FOV.

If the beam focus is stable and does not experience a significant focal shift, the best practice for reaching ISO compliance is to lower the build plate location farther than the calibrated distance by a maximum of 5mm. This will cause the focal point to occur higher in the detector's FOV and prevent any possible damage to the turning mirror.

If the focal point shifts outside of the FOV then the build plate location can be raised a maximum of 5mm from the calibrated distance to attempt to capture the entire focal shift. If the beam's focal point falls outside of the FOV the result accuracy is degraded.

# Chapter 2 Setup

## 2.1 Mounting Hardware

Place the BeamWatch AM unit in the build chamber approximately where the beam can enter the input aperture unobstructed.

BeamWatch AM employs three ball bearings at its base to maintain three points of contact which keeps the unit level. Some build planes have holes for mounting. Make sure that none of the ball bearings fall into these holes. The unit may be rotated slightly as needed.

In most instances the weight of the unit keeps the unit in place. The user is responsible for any other means of securing the unit on the build plate.

Lower the build plane to the exact distance of the calibration sticker on the unit. This distance ensures that the Camera Axis and the Working Plane are level.

BeamWatch AM is spatially calibrated which allows the software to automatically calculate the distance between the working plane and the waist location of the beam.

The calibrated distance is measured from the point where the ball bearings rest on the build plate to the center of the camera FOV and is marked with a line on the side of the unit.

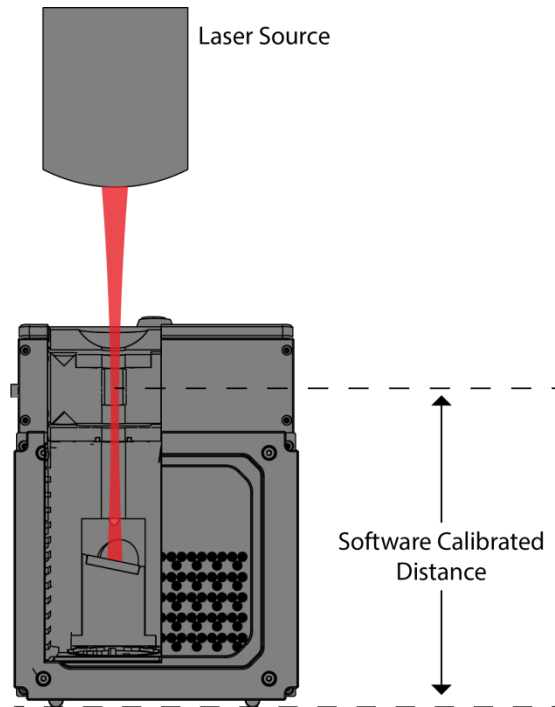
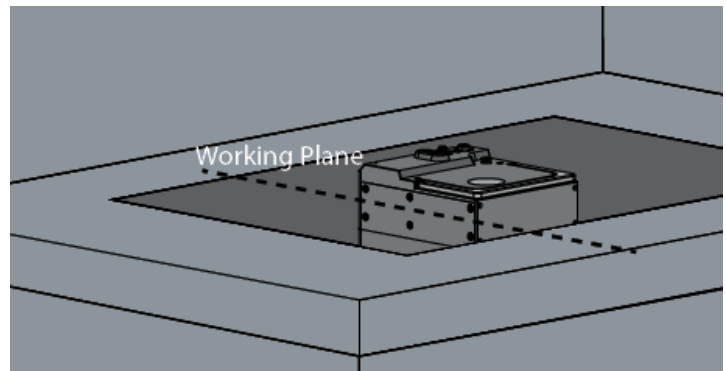
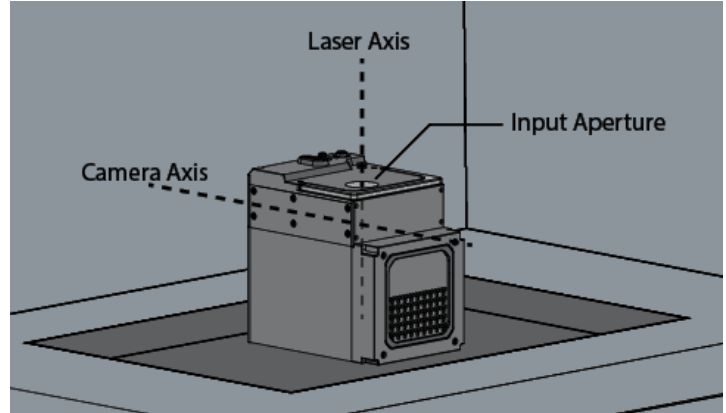

*Never apply the laser when the dust shutter is closed. The dust shutter can only be opened from inside the software when the purge gas is flowing. **See section 2.1.3.***

A 10 mm reference pin hole is present under the bottom plate to help aid with repeatable mounting. The bottom plate does not contain an access hole due to fan airflow. However this plate can be removed when in the build chamber.

Remove the bottom plate to locate the reference pin hole. The unit can be mounted to a custom build plate with a press fit dowel. If using the fan to cool the unit the plate must be reinstalled.

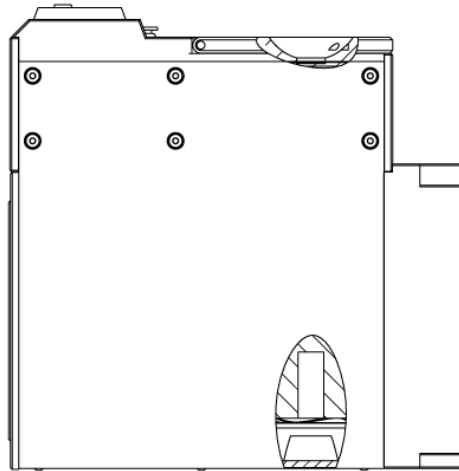

## 2.1.1 Connections

Additive manufacturing powder beds have high levels of particulates that must be removed from the camera FOV to obtain accurate results. With BeamWatch AM, this is accomplished by generating a laminar flow region at the camera FOV using a clean, dry gas source. Air, Nitrogen, or Argon is recommended.

Connect the provided tubing to the gas source as shown.

The 5/32" - 1/4" Air Hose Adapter and Additional 1/4" Air Hose are included in case they are needed.

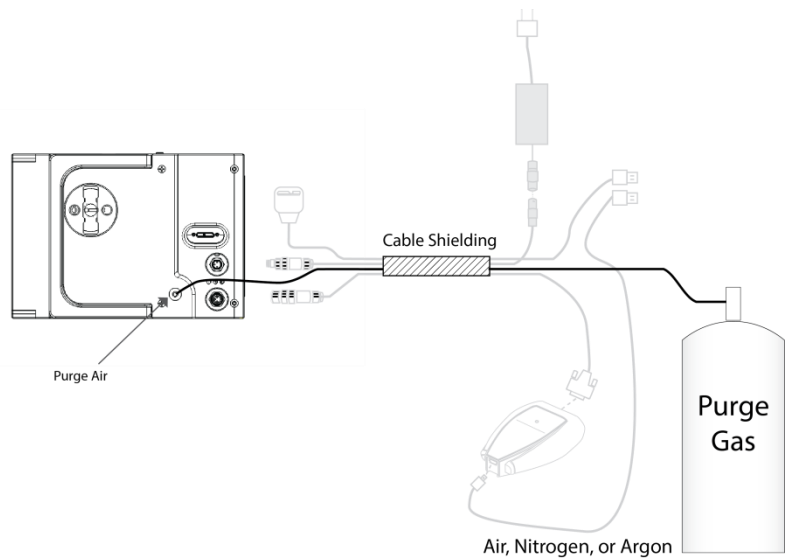

After connecting the purge gas, connect the electrical components.

1. Connect the provided power cord to the power port on the BeamWatch AM unit.
2. Connect the remaining end into a surge protected 100-240 VAC outlet.
3. Connect one end of the provided USB 3.0 cable into the data source on the BeamWatch AM unit.
4. Connect the remaining end into a USB port on the PC.
5. Connect the provided Power Sensor cable to the Sensor port on the BeamWatch AM and the remaining end to the Juno USB Interface.
6. Connect the provided USB mini-B cable to the port on the Juno and connect the other end to the PC.

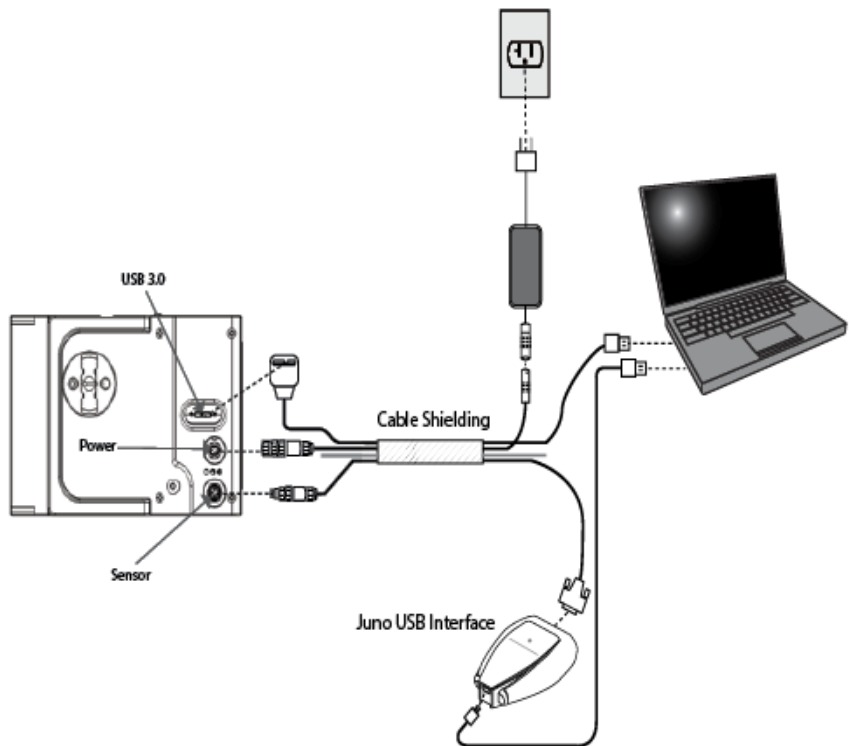

*Route all cables safely outside of the chamber before operation.*



*Calibration information is stored inside the wiring harness. **Always** make sure that the serial number and calibration date on the harness match what is listed on the BeamWatch AM unit.*



*If the BeamWatch software detects that the BeamWatch AM is not connected to external power a warning appears on screen.*

## 2.1.2 Interlock (Optional)

The Y-Distributor and Interlock cable are provided to allow you to integrate BeamWatch AM with your laser system. This can prevent accidentally applying the laser when the shutter is not open.

1. Connect the Y-Distributor to the power cable.
2. Connect the Interlock Cable to one side of the Y-Distributor.
3. Use the exposed wires to integrate BeamWatch AM into the laser interlock system.
4. Connect the power supply adapter to the Y-Distributor.
5. Connect the power supply adapter to a supply source.

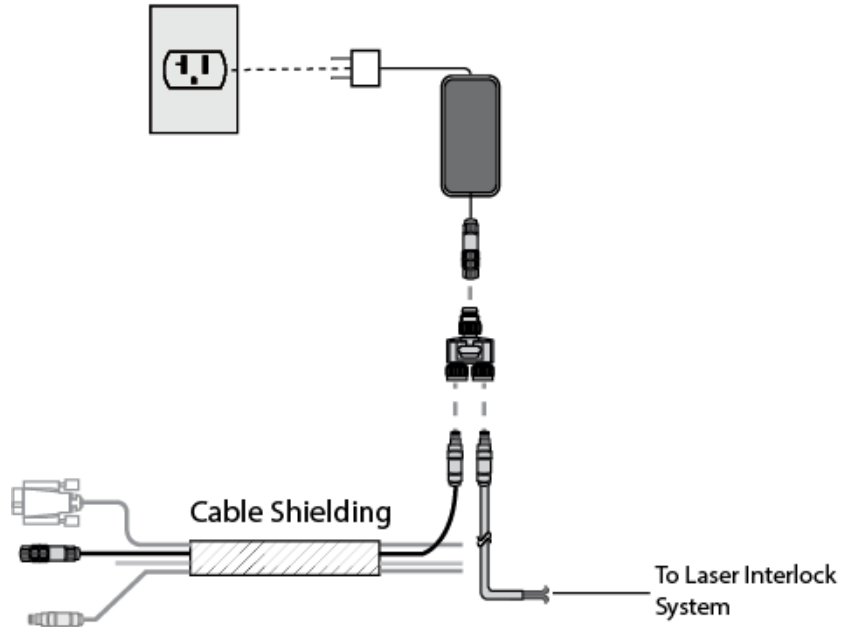

The following schematic is a wiring diagram for the Interlock Cable to be used when integrating into the laser interlock system.

Wire Color	Function
Brown	+12V
White	Interlock In (Common)
Blue	Ground
Black	Interlock Out (Normally Open)



*The interlock is a normally open contact that closes when the shutter opens.*

### 2.1.3 Laser Setup

1. Open the software, supply approximately 3 SLPM (35 PSI / 2.5 BAR) purge gas, and then select **Open** to open the shutter. **Do not exceed 8 SLPM (100 PSI / 6.5 BAR).**
2. Apply the guide beam. The alignment tool can only be used with a low power guide beam.

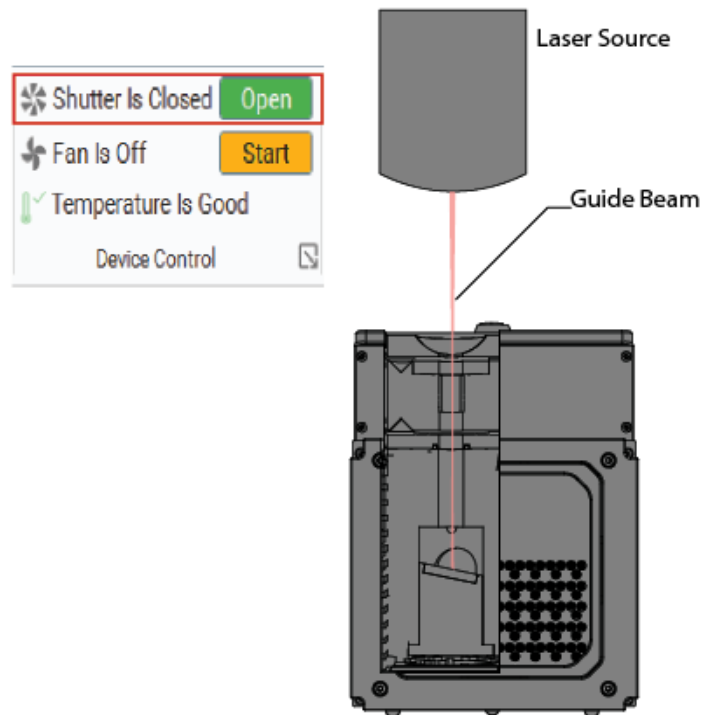

### 2.1.4 Alignment

BeamWatch AM is provided with an alignment tool accessory. For accurate results the beam must be aligned with the center of the input aperture, perpendicular to the top of the unit. A beam offset in any direction can produce inaccurate results and risk damage.

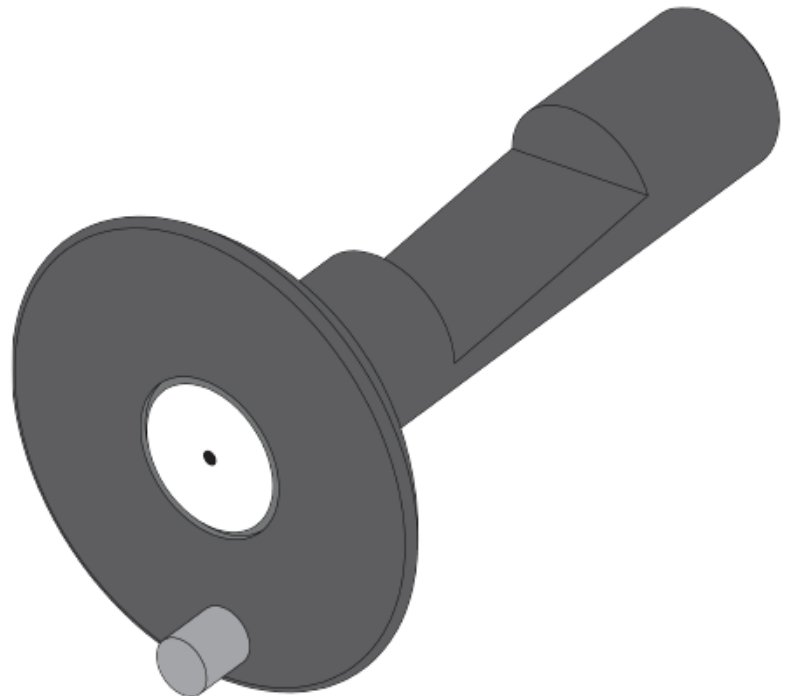

## 2.2 Using the Alignment Tool

1. Insert the alignment tool into the BeamWatch AM with the cutout side facing the camera as shown.
  - a. The alignment tool has an index to assist in guiding it into place. Hold the tool by the index and insert it into the aperture on the unit.
  - b. Place the index into the middle notch in the aperture to view the beam on both axes, or insert it left or right to view only one axis.
  - c. Ensure the alignment tool is flush with the top.

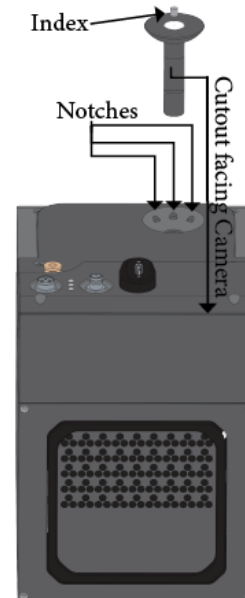

*The BeamWatch AM alignment tool is intended for use with low power alignment beams. -Do not turn the high power beam on when the alignment tool is in place-*

2. Start the BeamWatch software and enable the Crosshair located at the top of the 2D Beam Display window.





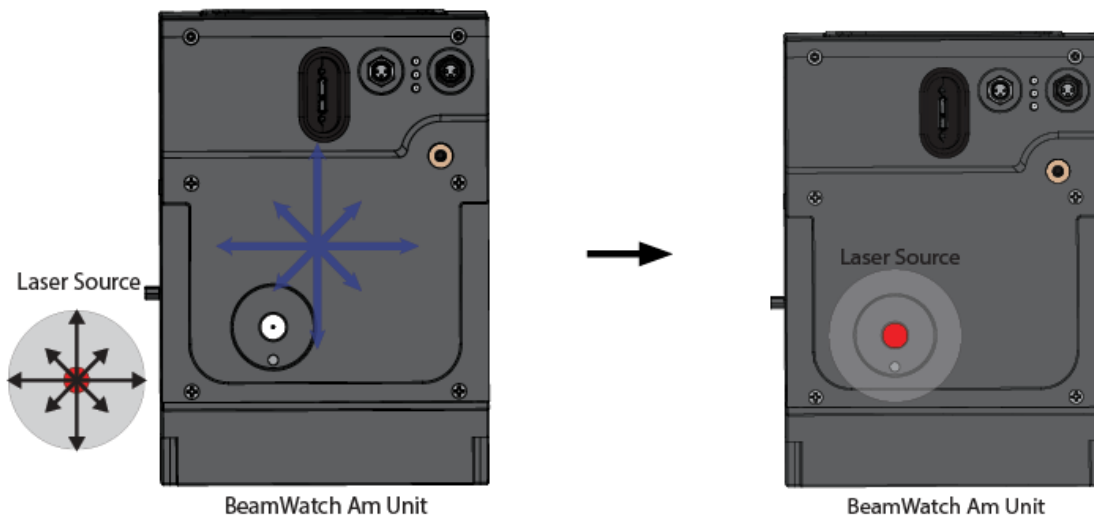

3. Turn on the alignment beam and center it on the alignment tool by adjusting either the beam or the BeamWatch AM unit, with the beam perpendicular to the BeamWatch as shown below.



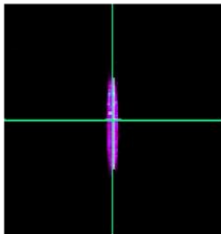
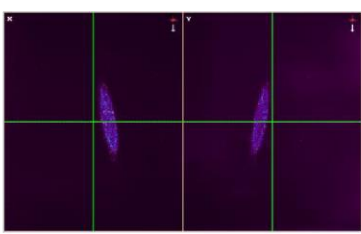
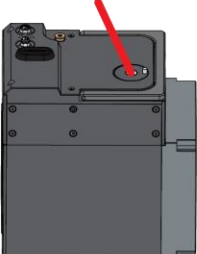
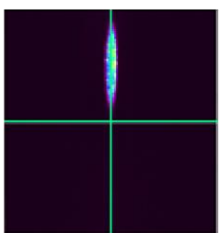
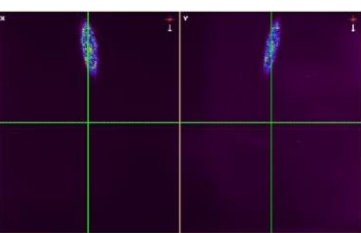
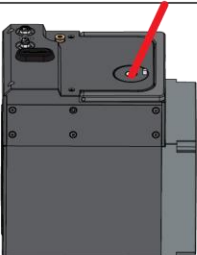
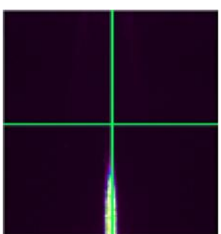
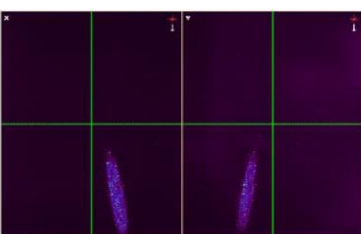

4. The beam will be displayed in the BeamWatch software as an ellipse as shown in the images below. It may be necessary to adjust the Exposure and/or Summing to bring the alignment beam to a viewable level.
5. If the beam is centered on the crosshair as shown in the properly centered example, the beam is aligned. If the beam is not centered it will be necessary to adjust the angle the beam enters the BeamWatch. The following illustrations show beam deviations and the resulting displays.

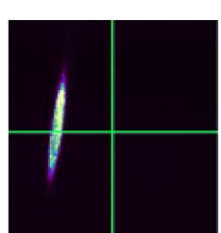
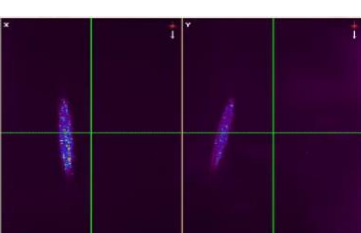
*The angle of the beam is exaggerated for clarity.*

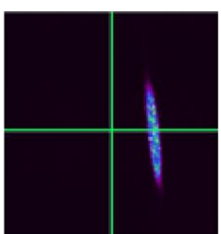
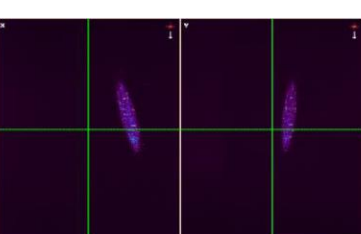
Alignment	Illustration	Index Offset	Index Centered
Properly centered			
Beam angled away from camera			
Beam angled toward camera			
Beam angled toward the left			
Beam angled toward the right			

6. Remove the alignment tool and use the concept below to make any necessary fine adjustments.
7. Watch the 2D Beam Display as you align the beam. The outer two vertical lines represent the bounds of the **Focal Plane Region** ( $\pm 350\mu\text{m}$ ). Align the beam within these bounds, in both views, to get the strongest results.

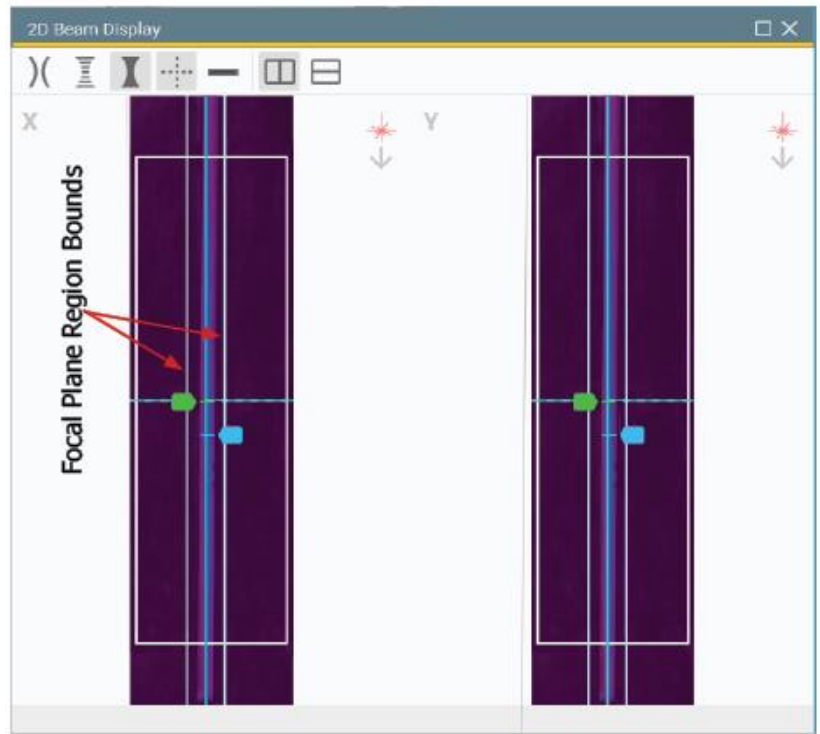

The diagram below shows how various degrees of misaligned beams appear on the screen.

The **red** beam is off in the view of the Y axis. It needs to be moved down and left to center.

The **blue** beam is off in both axes and appears close to the insides of the views. It needs to be moved up to center.

The **purple** beam is off in the view of the X axis. It needs to be moved down and right to center.

The **green** beam represents a perfectly aligned beam.

The **orange** lines represent the field of view of each axis.

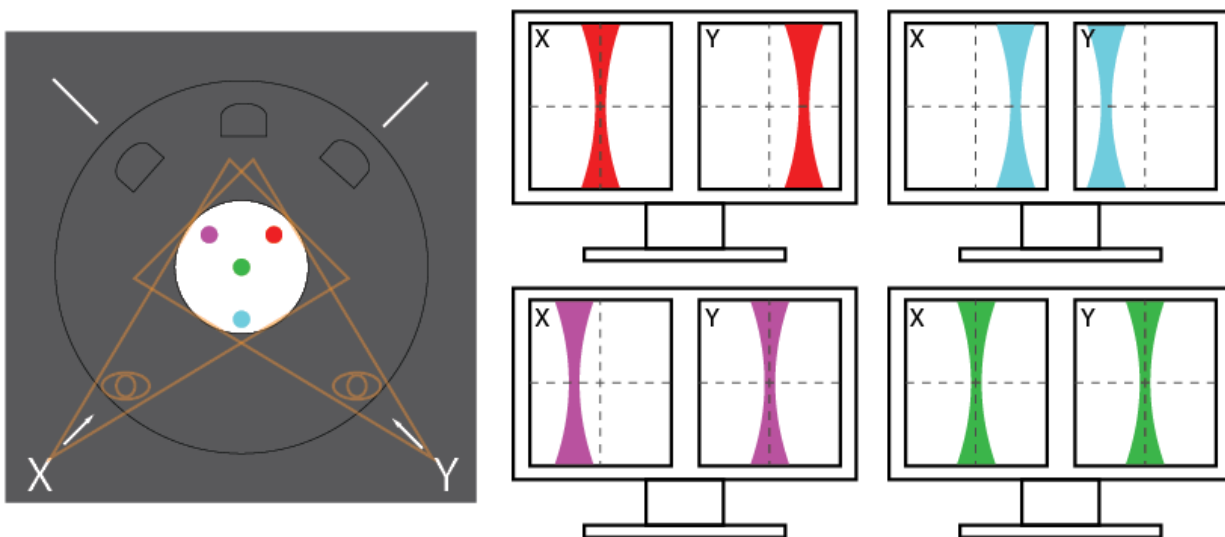

## 2.2.1 Operating Limits

The high powered lasers used in additive manufacturing generate a large amount of heat which limits how long measurements can be taken. See the chart below to see how long measurements can be taken based on Power levels.

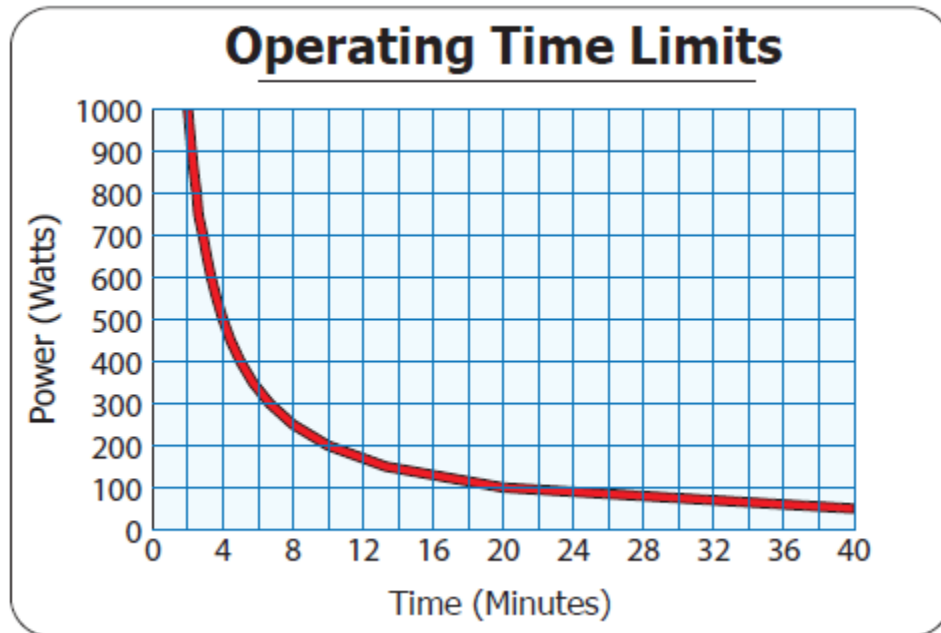

## 2.2.2 The Halo Aperture

In some applications extra light besides the main beam can enter the BeamWatch AM and cause an increase in background signal. This makes it difficult to see the beam and can reduce measurement accuracy. To minimize this effect insert the Halo Aperture into the input aperture after the beam has been properly aligned.

Make sure that the beam diameter does not exceed 4.5 mm as it enters the Halo Aperture.

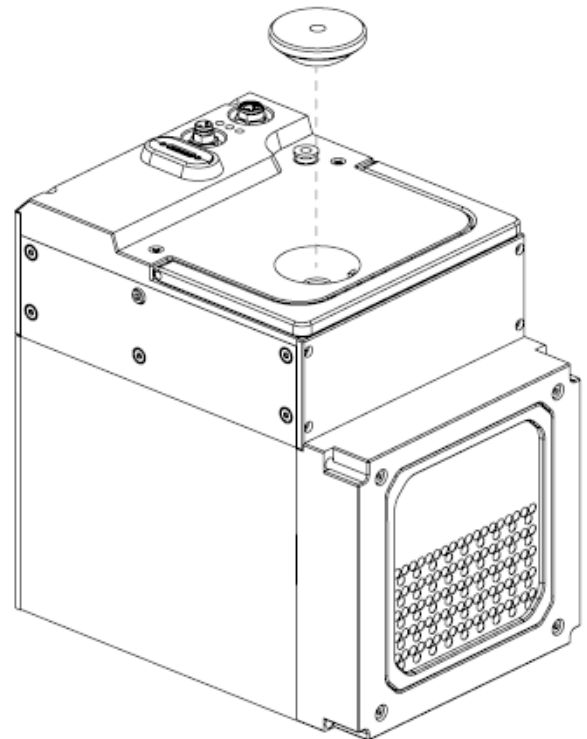

# Chapter 3 Maintenance

## 3.1 Replace Air Filters

Air filters should be changed every 10 hours of operation.

1. Use a flat tool, like a flathead screwdriver, to remove the Filter Retainer.
2. Remove the Filter Guards as well as the filter that is interposed between the shields.
3. Insert the new Filter between the filter shields.
4. Insert the Filter and Filter Guards back into the BeamWatch AM unit.
5. Replace the Filter Retainer by applying gentle pressure.

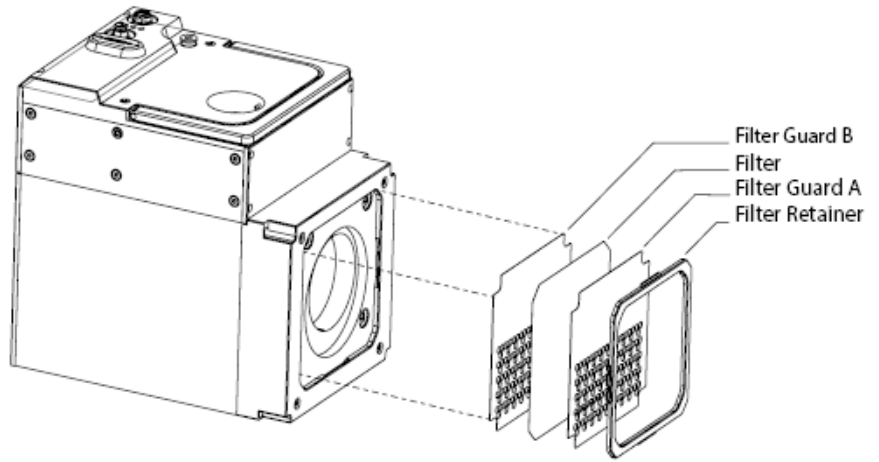

Air filters are a replaceable part and can be purchased. See Appendix B Replacement Parts.

### 3.1.1 Cleaning the Mirror

If dust gets on the mirror it can either increase the background signal in the measurement or more likely can burn off the mirror coating which can lead to more components getting severely damaged. The Turning Mirror should be cleaned after every five hours of operation. **Safety eye-wear required for this process.**

We strongly recommend purchasing and using Newport Optic Cleaning Kit, Red Polymer, Brush Applicator MODEL: RFCR

1. Wear safety eye-wear and clean gloves to prevent damage to self and fine components.
2. Use a screwdriver to remove the four screws located on the Base Plate. Set aside and do not lose.
3. Remove the Base Plate.
4. Use the provided retaining ring pliers to remove the exposed Retaining Ring.
5. Remove the Wave Ring.
6. Place a clean optical quality tissue on the table and gently tilt the BeamWatch AM unit to catch the Beam Dump Mirror Assembly.

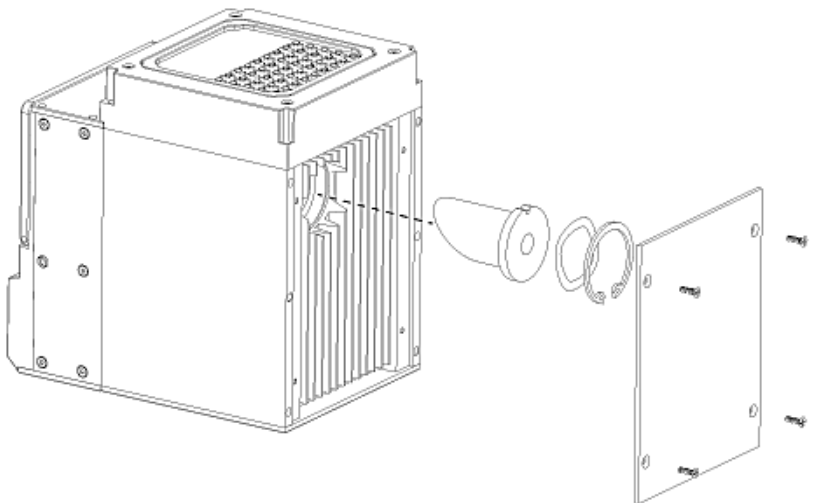

7. Blow a clean, dry gas onto the mirror to remove any dust buildup. If using canned air keep the can as vertical as possible to prevent any liquid getting on the mirror assembly.
8. Review the instructions in Newport cleaning kit web page.
9. Use the Pipette included in the Cleaning Kit to apply enough Polymer Cleaning Solution to the entire mirror.

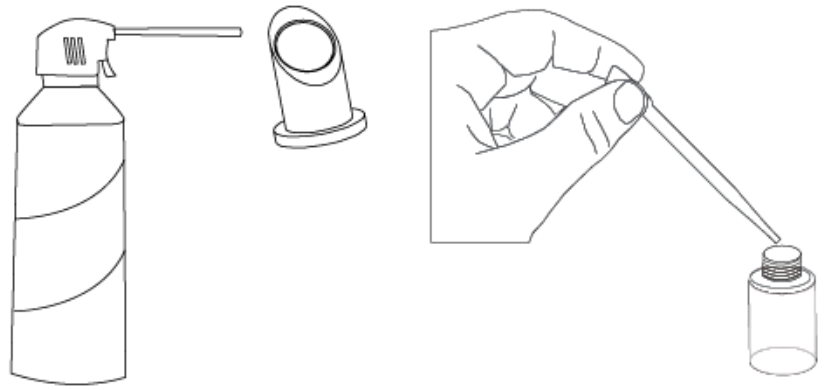

10. Spread Polymer Cleaning Solution across the mirror.

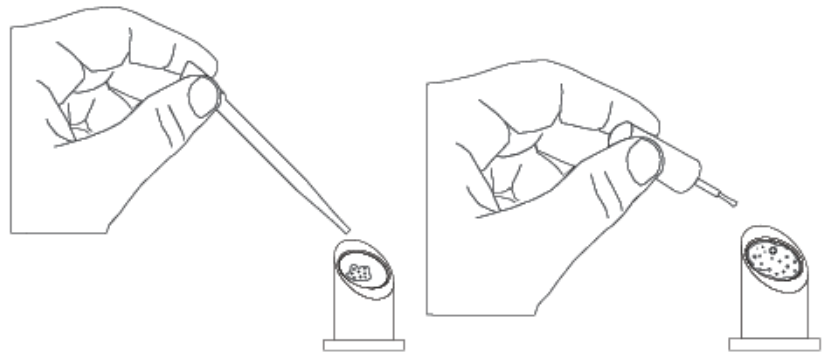

11. Allow 15-20 minutes for the solution to cure.
12. Carefully remove the solution with one of the included Peel Tabs.

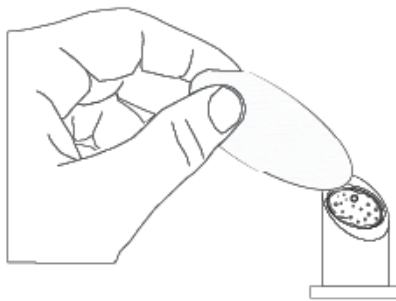

13. Replace the Beam Dump Mirror Assembly. Make sure the index lines up with the notch on the assembly.
14. Replace the Wave Ring, Retaining Ring, and Base Plate
15. Secure the plate with the four screws.

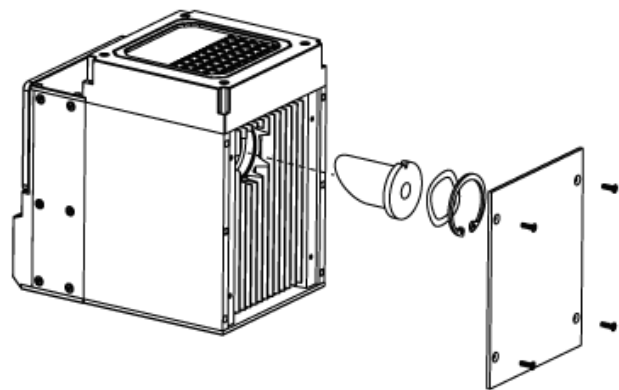

In the event of damage replaceable parts can be purchased. See Appendix B Replacement Parts.



### 3.1.2 Recalibration

BeamWatch AM needs to be sent to Ophir-Spiricon annually (date noted on calibration label) for recalibration to maintain accurate readings. **Because the calibration is stored in the wiring harness, it must be included when shipped.** When shipping make sure to lock the shipping case with the provided key. **Do not ship the key, the calibration team will have a key to unlock the box.** Please contact the Ophir-Spiricon Service Department at (435) 753-3729 to schedule calibration.

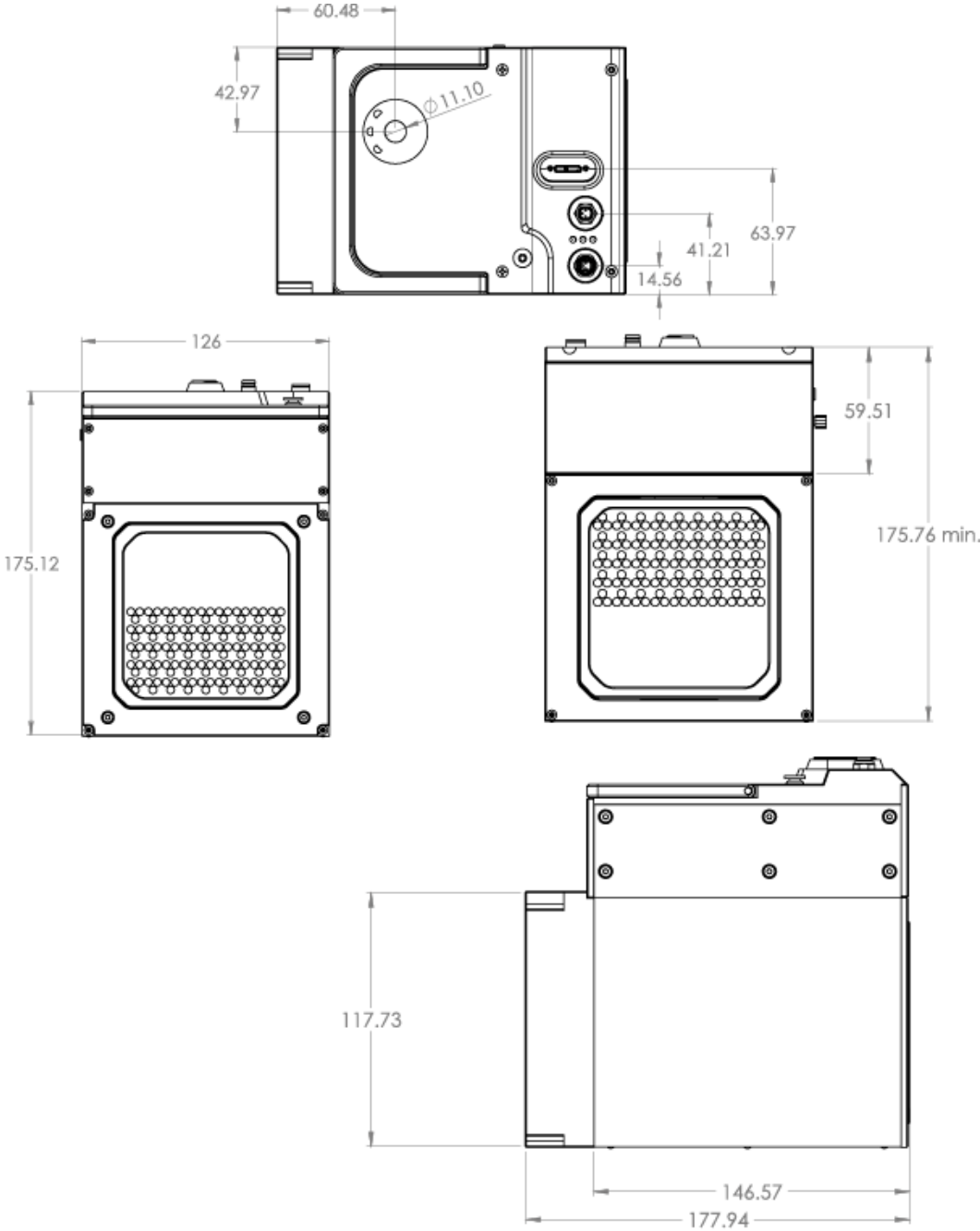

# Appendix A Dimensions

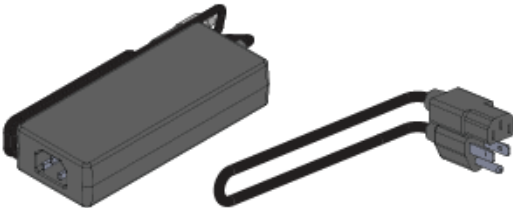
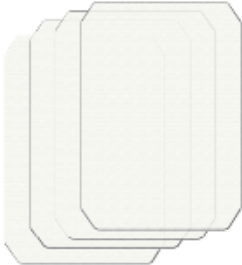
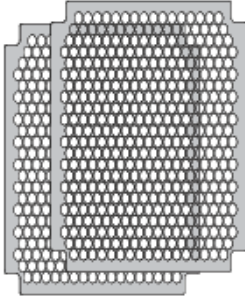

## Appendix B Replacement Parts

Part Number	Description	Image
SP90486	Retaining Ring and Wave Ring	
SP90487	Power Supply	
SP90488	Replacement Filters (4)	
SP90489	Filter Guards (2)	
SP90490	Filter Retaining Ring (2)	

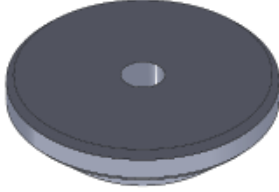
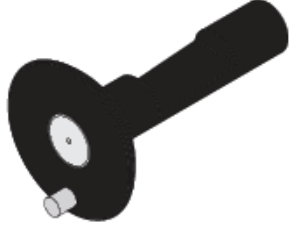

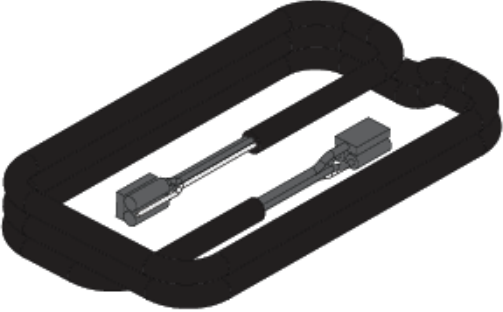
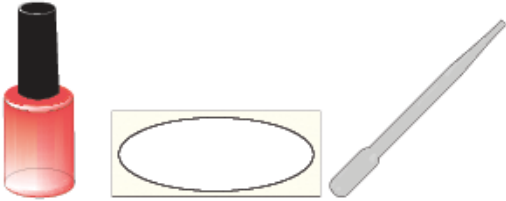
Part Number	Description	Image
SP90491	Turning Mirror, 40 mm Retaining Ring, and 40 mm Wave Spring	
SP90493	Halo Aperture	
SP90494	Alignment Tool	
SP90495	Interlock Cable and Y-Distributor for Interlock	
SP90496	Wiring Harness	
Newport Model RFCR	Newport Optic Cleaning Kit	







## Notice

**BeamWatch AM**<sup>®</sup> is a registered trademark of Ophir-Spiricon, LLC and is protected under United States Patent No. 8,988,673.

**Windows**<sup>®</sup> is a registered trademark of Microsoft Corporation.

All rights to the product and any accompanying user guide(s) are reserved by Ophir-Spiricon, LLC. Ophir-Spiricon, LLC reserves the right to make improvements to the product described in this user guide at any time and without prior notice.

While every precaution has been taken in the preparation of this guide, the publisher and author assume no responsibility for errors, omissions, or any loss of data because of said errors or omissions. Personal computer hardware and component manufacturers, along with operating system providers constantly revise their products and software upon which this product is dependent. While Ophir-Spiricon, LLC endeavors to maintain maximum compatibility with a wide variety of personal computer configurations, Ophir-Spiricon, LLC makes no guarantee that any one brand or model of personal computer will be compatible with any or all of the features contained in this application, either now or in the future.

Obtain the latest version of this user guide at <https://www.ophiropt.com/laser--measurement/beam-profilers/services/manuals>