

E-SAMPLER

PARTICULATE MONITOR

OPERATION MANUAL

REVISION P



Met One Instruments, Inc.
1600 NW Washington Blvd.
Grants Pass, Oregon 97526
Telephone 541-471-7111
Facsimile 541-471-7116

E-SAMPLER Particulate Monitor Operation Manual - © Copyright 2011 Met One Instruments, Inc. All rights reserved worldwide. No part of this publication may be reproduced, transmitted, transcribed, stored in a retrieval system, or translated into any other language in any form without the written permission of Met One Instruments, Inc.

Table of Contents

1	INTRODUCTION.....	5
1.1	About This Manual.....	5
1.2	Technical Service	5
1.3	About the E-Sampler – Two Instruments in One	6
1.4	Laser Radiation Safety and Conformity.....	6
1.5	E-Sampler Specifications	7
2	E-SAMPLER SETUP and STARTUP	8
2.1	Standard and Optional Accessories	8
2.2	Mounting Options.....	8
2.3	Setting Up the E-Sampler.....	9
2.4	Electrical Connections	13
2.5	Power-Up and Starting Operation	14
3	SITE SELECTION and REMOTE POWER OPTIONS.....	15
3.1	Site Selection Requirements.....	15
3.2	Fall Hazard and Security Cautions	16
3.3	Confined Sampling Locations	16
3.4	Smoke and Ash Monitoring	17
3.5	Remote Monitoring With Solar or Battery Power	17
4	E-SAMPLER USER INTERFACE and MENU SYSTEM.....	20
4.1	The User Interface - Keypad and Display Functions.....	20
4.2	Using the Main Sampling Screen	21
4.3	Using the Main E-Sampler Menu System and Clearing Memory	22
5	E-SAMPLER MEASUREMENT METHOD.....	24
5.1	Forward Laser Light Scatter Nephelometer System	24
5.2	47mm Gravimetric Filter Collection System	26
5.3	The Airflow Control System Diagram and Description.....	27
5.4	Timed Operation and Scheduled Sampling Events.....	29
5.5	Establishing a Gravimetric Correction K-Factor for the E-Sampler.....	29
6	SETUP MENU DESCRIPTIONS	32
6.1	The CLOCK Setup Screen.....	32
6.2	The AVERAGE PERIOD Setup Screen – Data Logging Interval.....	32
6.3	The CONCENTRATION Setup Screen – Range and Scaling	33
6.4	The SAMPLING MODE Setup Screen – Continuous or Timed Sampling	34
6.5	The ALARM CONTACT Setup Screen.....	34
6.6	The RH Control Setup Screen	35

6.7	The SELF-TEST Setup Screen – Zero and Span Settings	35
6.8	The COMMUNICATION Setup Screen	36
6.9	The STATION ID Setup Screen	36
6.10	The ENGINEERING UNITS Setup Screen.....	36
7	CALIBRATE MENU – FIELD CALIBRATIONS	37
7.1	Ambient Temperature Calibration	37
7.2	Ambient Pressure Calibration	38
7.3	External RH Sensor Calibration.....	38
7.4	Flow Sensor Calibration.....	39
7.5	DAC Calibration – Analog Output Adjustment	39
7.6	Leak Test Calibration Checks.....	40
8	MAINTENANCE and TROUBLESHOOTING	41
8.1	E-Sampler Alarm Displays, Alarm Logs, and Alarm Codes	41
8.2	Contact Closure Alarm Relay Output	43
8.3	Basic Problem and Cause/Solution Table	43
8.4	Suggested Periodic Maintenance Intervals	45
8.5	Sample Pump Replacement	45
8.6	PUMP and PURGE Filter Changes	47
8.7	TSP Inlet and Cyclone Cleaning	47
8.8	Factory Service Interval.....	47
8.9	Operational Logic for Self-Test and Laser/Detector Alarms.....	49
9	DATA RETRIEVAL and COMMUNICATIONS.....	52
9.1	Analog Voltage Output.....	52
9.2	Serial Port Connections to a Computer.....	52
9.3	Modem Options for Remote Data Retrieval.....	52
9.4	Comet™ Data Retrieval Software	53
9.5	Downloading Data Using HyperTerminal.....	53
9.6	“AutoMet” Data Retrieval Commands Through the Serial Port	55
9.7	Advanced Communications – Escape Commands	57
9.8	Flash Firmware Upgrades	59
10	ACCESSORIES and PARTS.....	60
10.1	Consumables, Replacement Parts, and Accessories	60

1 INTRODUCTION

1.1 About This Manual

This document is organized with the most important information grouped together for easy reference by the user. All E-Sampler owners and operators should read and understand the sections on installation, setup, and field calibrations. Other sections that provide in-depth information on subjects such as theory, diagnostics, accessories, and alternate settings provide valuable information which should be consulted as needed. An electronic version of this manual is also available.

1.2 Technical Service

This manual is structured by customer feedback to provide the required information for setup, operation, testing, maintaining, and troubleshooting your E-Sampler unit. Should you still require support after consulting your printed documentation, we encourage you to contact one of our expert Technical Service representatives during normal business hours of 7:00 a.m. to 4:00 p.m. Pacific Time, Monday through Friday. In addition, technical information and service bulletins are often posted on our website. Please contact us and obtain a Return Authorization (RA) number before sending any equipment back to the factory. This allows us to track and schedule service work and to expedite customer service.

Phone: **(541) 471-7111**

Fax: (541) 471-7116

E-Mail: service@metone.com

Web: www.metone.com

Address: Technical Services Department
Met One Instruments, Inc.
1600 NW Washington Blvd.
Grants Pass, OR 97526

1.3 About the E-Sampler – Two Instruments in One

The Met One Instruments, Inc. model *E-Sampler* is a type of nephelometer which automatically measures and records real-time airborne PM₁₀, PM_{2.5}, or TSP particulate concentration levels using the principle of forward laser light scatter. In addition, the E-Sampler has a built-in 47 mm filter sampler which can optionally be used to collect the particulate for subsequent gravimetric mass or laboratory evaluation. The E-Sampler combines the excellent real-time response of a nephelometer with the accuracy and traceability of a low flow manual gravimetric sampler. Detailed descriptions of the E-Sampler measurement modes can be found in Section 5.

Laser Light Scatter System

Sample air is drawn into the E-Sampler and through the laser optical module, where the particulate in the sample air stream scatters the laser light through reflective and refractive properties. This scattered light is collected onto a photodiode detector at a near-forward angle, and the resulting electronic signal is processed to determine a continuous, real-time measurement of airborne particulate mass concentrations.

Gravimetric Filter Sampler System

After the sample air stream has been measured by the E-Sampler and exits the optical engine, it passes through the built-in 47 mm filter sampler system. This system allows the particulate to optionally be collected on a filter disc as a second method to obtain airborne particulate mass data, or for laboratory analysis of the particulate.

The 47 mm filter system can also be used to determine a gravimetric K-factor (slope multiplier) to correct the E-Sampler real-time signal to match the local particulate type. In this case, a filter disc is weighed on a microbalance before and after being run in the E-Sampler for a period of time. The resulting mass of the dust on the filter is correlated with the concentrations that the E-Sampler recorded over the same time period, and a correction factor is calculated. The E-Sampler can be used with no correction factor in applications where relative particulate trending is appropriate.

1.4 Laser Radiation Safety and Conformity

The E-SAMPLER, when properly installed and operated, is considered a Class I laser product. Class I products are not considered to be hazardous.

This system contains a diode laser operating at 5 mW power and 670 nm wavelength. This is visible to the naked eye, and can cause damage to the eye if directly exposed. A protective optical housing fully encapsulates the laser beam and optics system within the E-SAMPLER. Do not attempt to disassemble the optical module. Failure to comply with this instruction could cause accidental exposure to laser radiation. The manufacturer certifies that this product operates in compliance with following standards and regulations:

- **FDA / CDRH This product is tested and complies with 21 CFR, Subchapter J, of the health and Safety Act of 1968.**
- **US 21 CFR 1040.10.**

Always power down the system whenever service or repair work is being performed inside the instrument enclosure. Only trained technicians should attempt to repair the E-Sampler. Routine maintenance does not require removing the instrument from its weatherproof enclosure.

1.5 E-Sampler Specifications

PARAMETER	SPECIFICATION
Measurement Principles:	Particulate concentration by forward light scatter laser Nephelometer. Integrated 47mm low flow gravimetric filter sampler.
Available Cut Points:	TSP Inlet Standard. PM ₁₀ , PM _{2.5} , and PM ₁ sharp-cut cyclone inlets available.
Measurement Range:	0 to 65 mg/m ³ (0 to 65,530 µg/m ³) dynamic range. 16 bit digital range.
Nephelometer Accuracy:	± 10% to gravimetric method typical when K-factored to local particulate type.
Gravimetric Accuracy:	± 8% of NIOSH 0600.
Precision:	Greater of 3 µg/m ³ or 2%.
Data Storage Resolution:	1 µg/m ³
Data Storage Intervals:	User-Selectable 1, 5, 10, 15, 30, or 60 minute averages.
Nephelometer Interval:	1-second measurements, available on analog output and display.
Sample Cycles:	Continuous operation or programmable scheduled sample runs.
Particle Size Sensitivity:	0.1 to 100 micron. Optimal sensitivity 0.5 to 10 micron particles.
Laser Type:	Diode Laser, 5 mW, 670nm. Visible red.
Long Term Stability:	5% with clean optics.
Flow Rate:	2.0 liters/minute ± 0.1 lpm. Actual volumetric flow.
Pump Type:	10,000 hour brushless diaphragm sample pump and secondary purge pump.
Gravimetric Filter Type:	47mm disc filters (not included). Accepts standard FRM filter holder cartridges.
Automatic Zero and Span:	User-selectable 15 min, 1 hour, 2 hour, 12 hour, or 24 hour intervals. 2.8 min cycle.
Internal Battery:	Optional lead acid battery, 12V, 12 Amp-Hour. Yuasa NP12-12 or equivalent.
Internal Battery Run Time:	Up to 30 hours with inlet heater off. Up to 10 hours with inlet heater on.
Power Supply:	Universal 100-240 VAC input, 15 VDC output power supply included. Compatible with solar power kits or external batteries using optional DC power cable.
Power Consumption:	1.1 amps @ 12 VDC (15 Watts) max continuous draw, running with inlet heater on. 0.35 amps (4.2 Watts) running with inlet heater off.
Operating Temperature:	0 to +50°C . (Ambient Temperature Sensor Range -30 to +50°C).
Barometric Pressure:	60,000 to 104,000 Pascal pressure sensor range.
Ambient Humidity Range:	0 to 90% RH, non-condensing.
Humidity Control:	Automatic 10 Watt inlet heater module controlled to sample RH setpoint. Sample RH sensor standard. Optional EX-593 ambient RH sensor available.
Approvals:	CE, ISO-9001. Designed to agree with EPA Class I and Class III FRM/FEM particulate samplers and monitors. Not an EPA-designated equivalent method.
User Interface:	Menu-driven interface with 4x20 character LCD display and dynamic keypad.
Analog Voltage Output:	0-1, 0-2.5, or 0-5 volt DC output. User-set range with 1-second real-time output.
Serial Interface:	RS-232 2-way serial port for PC, datalogger, or modem communications.
Alarm Contact Closure:	Normally closed contact closure relay output. Contact rating 0.5A @ 100V DC max.
Compatible Software:	Comet™ (included), Air Plus™, terminal programs such as HyperTerminal®
Alarm Reporting:	Available through serial port data files, display, and relay output.
Memory:	4369 data logger records (182 days @ 1 record/hr, 3 days @ 1 record/min).
Factory Service Interval:	24 Months typical, under continuous use in normal ambient air.
Mounting Options:	Pole or wall mount bracket standard. Optional EX-905 tripod recommended.
Unit Weight:	6.4 kg (14 lbs) without tripod, battery, or optional accessories.
Unit Dimensions:	65cm high, 27cm wide, 16.5cm deep. (25.5" x 10.5" x 6.5"). With inlet assembly

Specifications may be subject to change without notice.

2 E-SAMPLER SETUP and STARTUP

The E-Sampler is designed for rapid deployment and easy setup by a single person in less than 15 minutes in most applications. This section describes the basic assembly, setup, and start-up of the instrument.

2.1 Standard and Optional Accessories

When unpacking a new E-Sampler, verify that the contents are undamaged. If the shipping cartons are damaged, notify the carrier immediately. Verify that the included accessories are correct and complete. If anything is missing, contact the technical service department at service@metone.com or (541) 471-7111. See the Accessories section at the back of this manual for more details. The normal configuration of the E-Sampler is supplied with the following standard accessories:

- Weatherproof universal AC to 12VDC power supply.
- 47 mm filter cassette assembly.
- COMET data acquisition software.
- Weatherproof TSP inlet with debris screen.
- Serial communications cable.
- Instruction manual.
- Internal fused battery harness.
- 3/16" Allen wrench.
- Pole/wall mounting bracket.

The following optional accessories may or may not also be included, depending on the order:

- EX-905 Aluminum Tripod.
- Sharp Cut Cyclone for PM₁₀, PM_{2.5} or PM₁ cut-points.
- EX-034 Wind Speed and Wind Direction sensor.
- EX-593 Ambient RH Sensor.
- Internal Battery, 12V, 12aH.
- External DC power cable for batteries or solar systems.
- Extra 47 mm filter holders or filters.
- Modem Kits for phone line, cell, radio, or satellite telemetry.
- Solar power kits (usually drop-shipped from the solar manufacturer).

2.2 Mounting Options

Custom Pole or Wall Mounting:

The E-Sampler can be mounted to a pole, mast, or wall using the included mounting bracket. The bracket must be screwed or bolted to the pole or wall with appropriate hardware. The enclosed bolts may not be appropriate for the desired mounting. The slot on the back of the E-Sampler slips over the tab on the mounting bracket. The tab on the bottom of the E-Sampler should also be bolted to the mounting surface to ensure that the unit cannot be knocked off of its mounting.

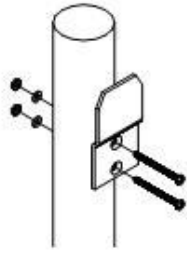

Typical Mounting Bracket Pole Installation

Note: If mounting the unit to a wall, take care to ensure that there is adequate clear space around the inlet to allow unrestricted airflow into the instrument. Wall mounting is often not considered ideal and not recommended due to the airflow and particulate obstruction of the wall itself. Mount the instrument with no large obstructions nearby whenever possible.

Tripod Mounting:

The Met One EX-905 aluminum tripod is the recommended mounting for the E-Sampler for most outdoor applications. It is not included as a standard accessory in order to save expense for users who may not require it. Deploy the tripod as follows:

1. Remove the three stainless steel detent pins from the tripod base by pulling the rings. Unfold the three tripod legs and reinsert the three pins so that each pin secures a leg in the open position. Make sure the erected tripod is rigid and stable.



Detent Pins

2. Lift the E-Sampler assembly and slide the slot on the back of the E-BAM over the tab on the top of the tripod. Insert the supplied $\frac{1}{4}$ -20 bolt through the tab on the bottom of the E-Sampler and through the hole in the body of the tripod. Secure it with the supplied washers and nut. This prevents the E-Sampler from falling or shifting on the tripod.
3. Site the tripod on a surface that is as level as possible. The tripod feet may be secured to the ground or mounting surface with bolts, screws, or tent pegs if necessary. Secure the tripod in windy conditions!

2.3 Setting Up the E-Sampler

Set up the rest of the E-Sampler hardware items and accessories as described below:

1. **Installing the inlet heater assembly:** The E-Sampler may be shipped with the inlet heater assembly disconnected for easier packing. Connect the heater power harness to the mating connector coming out of the top of the E-Sampler. Slip the inlet tube and heater assembly onto the top of the E-Sampler. Make sure that the inner aluminum inlet tube is

seated fully into the receiver inside the top of the E-Sampler. You may need to loosen the waterproof fitting at the top of the heater assembly in order to seat the inlet tube correctly. Align the three holes in the base of the plastic heater body with the threaded holes in the flange on top of the E-Sampler and fasten with three 6-32 socket head screws and lock washers as provided. Tighten the waterproof fitting on top of the heater assembly securely to prevent leaks.



- 2. Install PM₁₀, PM_{2.5} or PM₁ cyclones and TSP inlets:** For TSP (Total Suspended Particulate) monitoring, the included weatherproof TSP inlet is simply installed directly onto the top of the E-Sampler inlet tube to keep water, insects, and debris out of the instrument. For PM₁₀ or PM_{2.5} monitoring, the optional sharp-cut cyclone of the desired cut-point must be installed onto the inlet tube, under the TSP inlet. Lubricate the o-rings if necessary. Never operate the E-Sampler outdoors without at least the TSP inlet in place, as the resulting water/debris damage is not covered under warranty.



- 3. Optional wind sensor:** If an optional EX-034 wind speed/direction sensor is supplied, then it will come with a cross-arm tube which mounts to the stud on the top of the EX-905 tripod with supplied fittings. Install the wind sensor on the end of the cross-arm. The wind sensor should usually be as far from the E-Sampler unit as possible without affecting the tripod balance, and the wind vane must be able to rotate fully without hitting anything. Plug the wind sensor into the corresponding wind connector on the bottom of the E-Sampler. The sensor will need to be oriented to the north. Consult the separate manual that comes with the 034 wind sensor.
- 4. Internal Battery:** If the unit is to be used with the optional internal 12V battery, connect the included two-wire fused battery harness between the battery and the 2-pin connector J4 on the 81220 connector board inside the battery tray of the E-Sampler (red positive, black negative). Route the fish tape strap around the back of the battery, and slide the battery into the tray. Do not ship or transport the unit with the battery installed. See Section 3.5 for battery operation notes. The fuse is Met One 590807 (5 amp).



Internal battery and 81220 PCB battery harness connection

5. **AC Power Supply:** If the E-Sampler is to be operated on AC line voltage, install the included power supply. Bolt it to one of the legs of the tripod with the included U-bolts. Plug the power supply output cable into the DC power input on the bottom of the E-Sampler. When the power supply is plugged into AC power, the E-Sampler will turn itself on automatically. This power supply is also used to charge the optional internal 12 volt battery.

Note: If the E-Sampler is to be powered by an external battery or solar system, then these items will plug into the E-Sampler power input instead of the standard power supply. See Section 3.5.

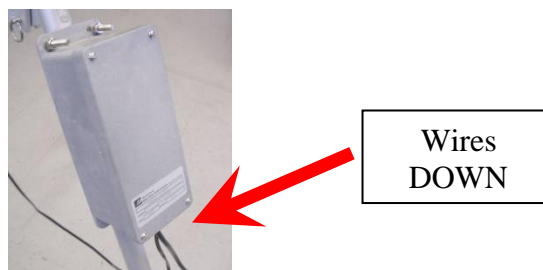

6. **Optional Met Sensors:** If the E-Sampler is supplied with other optional ambient sensors such as ambient RH (EX-593), then this sensor may be attached to the optional tripod with a cross-arm kit. Plug the sensor into the temperature sensor input on the bottom of the unit. **Note:** The E-Sampler has a built-in medium accuracy ambient temperature bead in the bottom of the case, and can operate volumetrically without an external temperature sensor.
7. **47 mm filter holder:** A 47 mm filter cassette assembly **must** be installed in the filter sampler position at all times, in order to seal the flow system. Pull down the spring-loaded filter clamp lever on the front of the unit to insert or remove the filter holder. **Note:** The filter cassette does not need to have a filter disc installed in it for real-time nephelometer operation, unless collection of the sample dust is desired. The backing screen disc may be left in the cassette. If a filter disc is installed, it must be removed after an appropriate amount of time. If forgotten, it will continue to collect dust until the flow system cannot continue to function. See section 5.



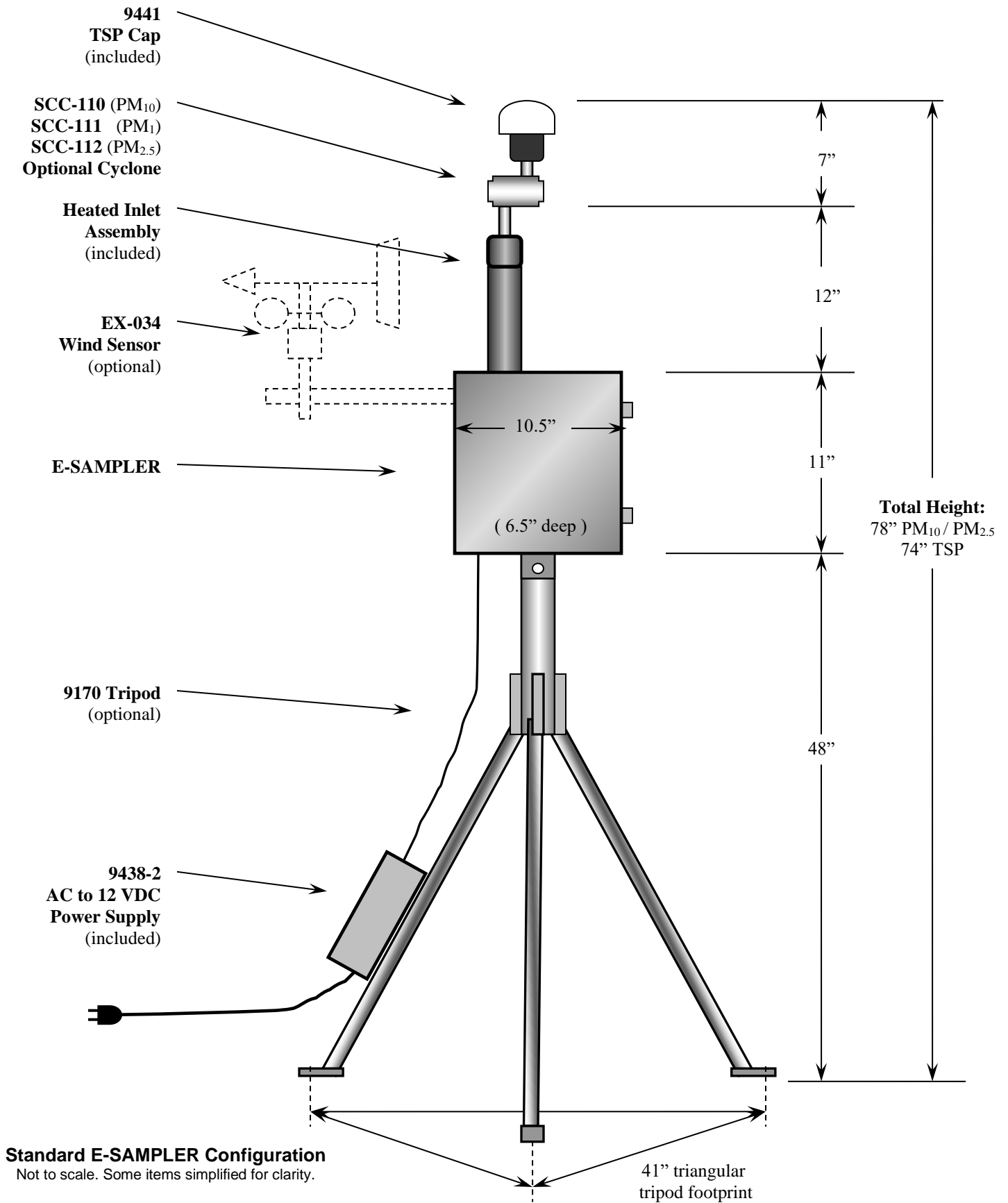

2.4 Electrical Connections

The standard E-Sampler has a set of weatherproof connectors on the bottom of the unit. These connectors provide the connections for the power supply, external sensors and communications options. Each connector has a different pin configuration to prevent plugging cables into the wrong connector. The E-Sampler will turn on automatically whenever a 12V power source is connected to the power input.

The analog voltage output is only available using a special serial cable with a break-out for the analog signal and ground wires. The standard 9321 E-Sampler serial cable does not have analog wires. To access the analog output signal, use the 9321-1 E-Sampler Serial Cable.

The E-Sampler chassis ground lug should be connected to an earth ground with the supplied grounding cable whenever possible, to reduce potential EMI/RFI electrical noise in the unit.

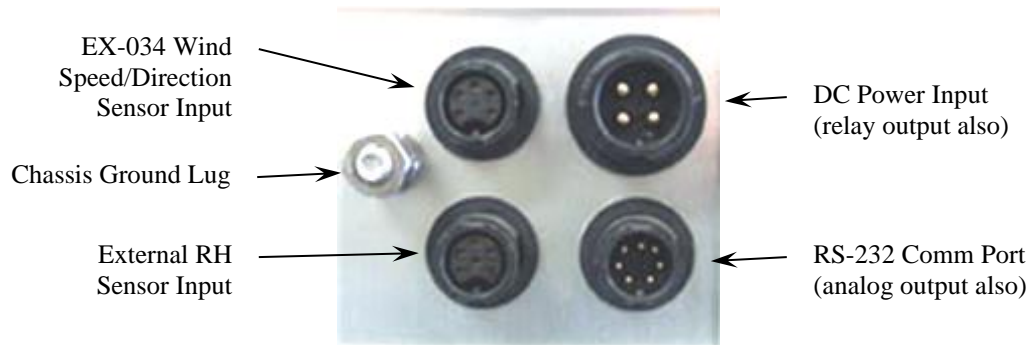

E-Sampler connector layout

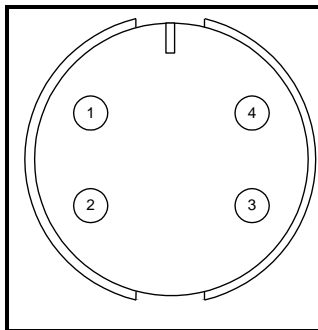

DC Power Input	
Pin	Function
1	+12 VDC Power In
2	Ground/Common
3	Alarm Relay IN
4	Alarm Relay OUT

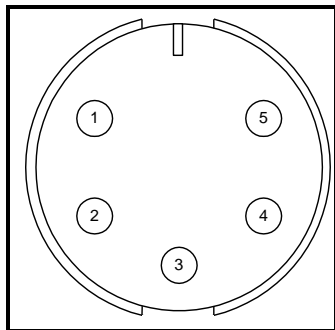

WS/WD Sensor In	
Pin	Function
1	Wind Direction Ref.
2	Ground/Common
3	Wind Direction Input
4	Wind Speed Input
5	Shield

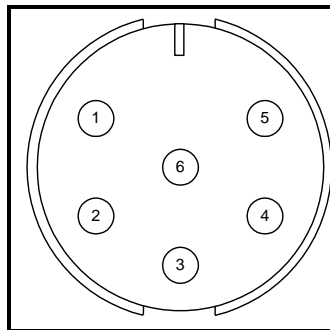

RH Sensor Input	
Pin	Function
1	RH Signal Input
2	Ground/Common
3	+12 VDC Output
4	Temp Signal Input
5	Baro Signal Input
6	Shield

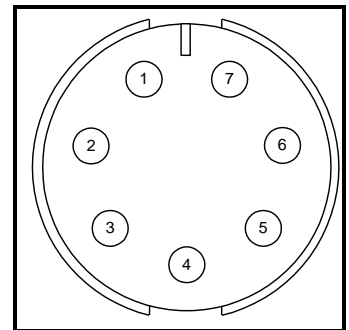

RS-232 Serial Port	
Pin	Function
1	RST
2	RX
3	TX
4	Ground/Common
5	STX
6	Analog Volt Output
7	TCK

2.5 Power-Up and Starting Operation

As soon as power is applied to the E-Sampler, the unit will boot up and display the ABOUT screen showing the firmware revision for a few seconds. The ABOUT screen can also be viewed through the menu system.

The E-Sampler will then default to the OPERATE screen as shown below. The START SAMPLE key (left menu key) must be pressed to start the unit. A confirmation screen will appear; press the YES key. The E-Sampler will begin by running a SELF-TEST process for about three minutes, where the optical zero and span functions will be checked.

After the SELF-Test process, the E-Sampler is running and ready to use, if set to CONTINUOUS sampling mode. The date, time, real-time concentration, flow rate, and sampling condition are displayed. For TIMED sampling operation details, see Section 5.4.

26-JUL-2011 15:49:06 CONC: UNIT OFF FLOW: 0.0 LPM START SAMPLE	26-JUL-2011 15:49:06 SELF-TEST RUNNING STOP SAMPLE	26-JUL-2011 15:49:06 CONC: 0.008 MG/M3 FLOW: 2.0 LPM STOP SAMPLE
---	--	---

Pressing the ▼ down arrow displays the other current sensor readings for AT, BP, RH, WS, WD, and battery voltage. Pressing the ◀ left arrow key will scroll back through historical logged data. Press ESC at any time to immediately return to the current concentration screen from any historical data screen. The MENU/SELECT key may be pressed at any time to enter the main menu screen. This screen is the top of a tree style menu system. Use the arrow keys to highlight an entry and press MENU/SELECT again to select that entry. Pressing ESC will back up along the tree to the top. See Section 4 for details about how to navigate the E-Sampler user interface and menu system.

Default Setup

The E-Sampler is factory configured to measure continuously with five minute data averages and hourly self-tests. The following table lists some of the factory default configurations which may need to be changed for your application. See Section 6 for details about the settings.

Parameter	Setting
Average Period	5 Minutes
Sampling Mode	Continuous
Self-Test Interval	Hourly
Time	Pacific Time
Concentration Range	65 mg/m3
K-Factor	1.0
RH Set Point	50%
Baud Rate	9600

3 SITE SELECTION and REMOTE POWER OPTIONS

Use the following criteria when deciding on a sampling location for the E-Sampler. Always consider the safety and security of the unit, as well as the suitability of the sampling environment.

3.1 Site Selection Requirements

Selection of a proper site for the E-Sampler is critical for accurate measurements. In some cases, these items must be correctly addressed in order for the collected data to be acceptable for regulatory requirements, such as ARM or SPM methods. Although the E-Sampler is not an EPA-designated instrument, U.S. EPA Specifications for the site selection are a good reference and can be found in the EPA documents listed below:

- 40 CFR, Part 58 Appendix E.
- Quality Assurance Guidance Document 2.12 “*Monitoring PM_{2.5} in Ambient Air Using Designated Reference or Class I Equivalent Methods*” Section 5.1.2.

The following is a summary of general ambient particulate monitoring site requirements that will be appropriate for use with the E-Sampler in many cases. Some of these criteria may not be appropriate in some applications, due to the versatile nature of the E-Sampler:

Inlet Height:

- The inlet should be located in the “breathing zone”, between 2 and 15 meters above ground level. When installed on the standard tripod, the E-Sampler inlet is positioned two meters above the ground or other mounting surface, when used with a cyclone.
- If the E-Sampler is to be collocated with other particulate instruments, such as FRM filter-type samplers or BAM units, then the air inlet must be the same height as the inlet of the other samplers, within one meter vertically. Within one foot is preferred.
- If the E-Sampler inlet is the highest point on a building, then lightning rods must be installed to prevent destruction of the unit during electrical storms.

Inlet Radius Clearance:

- The E-Sampler inlet should have a one meter radius free of any objects that may influence airflow characteristics, including the inlet of another instrument.
- If an E-Sampler is to be collocated at a station along with BAM or FRM samplers, the inlets of each sampler must be no less than one meter apart from each other, and no more than four meters apart. Two meter inlet spacing is recommended where possible.
- If installed near a PM₁₀ Hi-Volume sampler, then the distance between the inlet of the E-Sampler and the Hi-Vol must be no less than two meters.
- The E-Sampler inlet should be located away from obstructions such as short walls, fences, and penthouses, so that the inlet is unobstructed for two meters in all directions whenever possible. In some E-Sampler applications, this may not be entirely possible.
- If located beside a major obstruction (such as a building) then the distance between the E-Sampler and the building should be equal to twice the height of the building.
- The inlet should be at least 20 meters from the drip line of any overhanging trees.
- There should be at least a 270 degree arc of unrestricted airflow around the inlet. The predominant direction of concentration movement should be included in the arc.

Artificial Particulate Sources:

To avoid possible errors in the concentration measurements, the inlet must be located as far as possible from any artificial sources of particulate, such as blowers, vents, or air conditioners on a rooftop. Especially if any of these types of devices blow air across the inlet of the E-Sampler. Even sources of filtered air must not blow across the inlet.

Spacing from Roadways:

The E-Sampler should usually not be located directly next to a major highway or arterial roadway, as vehicle exhaust will dominate the concentration measurement. This effect can be difficult to predict accurately as shifting winds may direct the plume toward or away from the inlet. An obvious exception would intentional roadside particulate studies.

- Roads with a daily traffic volume of less than 3,000 vehicles are generally not considered major sources of pollutants, and in this case the E-Sampler should be located at least five meters from the nearest traffic lane.
- The E-Sampler should be located at least 25 meters from any elevated roadway greater than five meters high.
- The unit should be located as far as possible from unpaved roadways, as these also cause artificial measurements from fugitive dust.
- The unit should not be installed in unpaved areas unless year-round vegetative ground cover is present, to avoid the effects of re-entrained fugitive dust.

3.2 Fall Hazard and Security Cautions

If the E-Sampler is to be installed more than three meters above ground level, then the tripod legs must be bolted down to prevent the unit from falling to the ground. An accidental fall may cause major optical system damage requiring that the unit be returned to the factory for repairs. In addition, dropping the E-Sampler from any height will cause a potential safety hazard for those below, and may damage the unit beyond repair.

The E-Sampler tripod should be secured to the mounting surface in windy conditions to prevent the unit from falling over, even at ground level. This is especially important in winds over 30 mph. If bolt-down is not possible, then the tripod legs may be weighted down with sand bags or cinder blocks to secure the unit. Wind or fall damage is not covered under warranty.

The E-Sampler should be secured from theft or vandalism to the extent possible. A limited-access rooftop or a fenced lot are often good places to deploy the unit. Solar panels and batteries are highly susceptible to theft and should be secured.

3.3 Confined Sampling Locations

Because of the portable and versatile nature of the unit, the E-Sampler is sometimes deployed in confined or non-ambient locations to monitor localized particulate sources, such as tunnels, mines, quarries, shopping malls, train stations, etc. Each of these applications is unique and presents various challenges. We recommend that you contact a Met One Service representative to determine the suitability of the unit if you plan a custom deployment like this. In any case, the safety of those around the unit is paramount, and the protection of the unit from damage is very important.

3.4 Smoke and Ash Monitoring

A primary design use for the standard E-Sampler is for tracking smoke and ash plumes from wildfires, prescribed burns, agricultural burns, and even volcanic activity. In these cases, the unit is often sited at the outskirts of a populated area in the expected path of the smoke plume. The unit is usually equipped with the optional EX-034 wind speed and direction sensor for these applications, in order to correlate changing wind patterns with particulate events. The wind sensor is plug-and-play, and only requires an extended cross-arm for the tripod mount. The EX-034 will need to be oriented to the north for accurate wind direction measurements.

High concentration monitoring presents special considerations. The optical system in the E-Sampler will become dirty at a faster rate with more frequent factory service required. In addition, the internal purge air and pump protection filters will need more frequent replacement, and any 47 mm filters in the sampler system will need to be replaced more often in order to prevent flow system failures.

3.5 Remote Monitoring With Solar or Battery Power

The standard version of the E-Sampler is designed to be deployable in remote areas where AC power is not available. These applications may require external deep-cycle batteries, and sometimes a solar panel array as well. The E-Sampler is rated for a worst-case continuous power draw of 15 Watts (approximately 1.1 amps at 12 volts DC).

Internal Battery Operation:

The simplest method for remote deployment is to use the optional internal battery. The E-Sampler can run for up to 10 hours on a fully charged internal 12V 12 amp-hour battery, assuming worst-case conditions of high humidity and full time inlet heater operation. This increases to about 30 hours in low humidity with the inlet heater off. Battery run time is reduced in cold temperatures, or with a 47mm filter installed. The AC power supply included with the E-Sampler will serve as a battery charger for the internal battery whenever the unit is plugged into AC power. See Section 2.3 for instructions about how to connect the internal battery. The internal battery can be almost any 12 VDC lead acid battery with maximum dimensions of 3.9" width (100 mm) 3.85" height (98 mm) and 6" length (150 mm). Met One recommends using a YUASA NP12-12 battery. See www.yuasabatteries.com . Met One can supply these batteries on request, but it is usually cheaper and easier to source them locally.

External Battery Operation:

The E-Sampler can run for extended periods on external batteries. The most common type for this application are 12 volt, 110 amp-hour, gel-cell or AGM, deep cycle batteries. The setup will require a 9638 DC battery power cable which plugs into the main power connector on the bottom of the unit. The other end connects to the battery terminals. The batteries should usually be enclosed in a plastic box on the ground near the E-Sampler. **Note:** The E-Sampler AC power supply cannot be connected to the E-Sampler while external batteries or solar kits are connected, since these use the same power input connector. External batteries have to be manually removed and recharged elsewhere. The internal battery (if used) should be removed from the E-Sampler if external batteries are to be used.

Assuming a continuous E-Sampler current draw of 1.1 amps, a single fully-charged 110Ah battery would have the theoretical capacity to run the unit for 100 hours. However, the general rule is that

a lead-acid battery should not be discharged by more than 2/3 of its capacity, especially in temperatures below 40 degrees F, so:

$$((110\text{Ah} / 1.1\text{A}) * .67) = \text{about } \mathbf{67 \text{ hours}}$$
 of run time per battery (worst case).

However, if the inlet heater is not running full time, the battery will last much longer. Additional run time can be achieved by connecting more batteries **in parallel** to the first battery. Additional batteries **must** be of the same type! When the battery voltage discharges below 10.5 volts, the unit will shut itself down until fresh batteries are supplied and the restart voltage threshold is exceeded. See Section 8.1.

Solar Operation:

Some remote applications require operating the E-Sampler with a solar array. Care must be taken to ensure that the solar array is designed correctly, and is specified to meet the power requirements of the unit. Many people greatly underestimate the amount of solar wattage required to run a particular load continuously year-round. If the solar array is not large enough, the batteries will eventually become depleted and the E-Sampler will shut down.

The size of the solar array will vary depending on the Peak Sun-Hour (PSH) rating of the sample location. *PSH ratings are usually based on worst case winter conditions at a particular location.* Summer sun ratings at the same location will be considerably higher, requiring less solar wattage. Sun rating maps can be found on the National Renewable Energy Laboratory website at www.nrel.gov. The table below shows some estimated solar array wattages required to run a 15 Watt DC E-Sampler continuously in various sun ratings:

Local PSH Sun Rating kWh/m ² /day	Minimum Solar Array Wattage	Battery Array for 5 Days Backup
2.0	316	2 x 110Ah
2.5	353	2 x 110Ah
3.0	211	2 x 110Ah
3.5	180	2 x 110Ah
4.0	158	2 x 110Ah
4.5	140	2 x 110Ah
5.0	126	2 x 110Ah
5.5	115	2 x 110Ah
6.0	105	2 x 110Ah
6.5	97	2 x 110Ah
7.0	90	2 x 110Ah

Met One supplies a line of standardized portable solar power kits for use with the E-Sampler. Data sheets are available. These are usually drop shipped directly from the manufacturer, and work in most (but not all) areas and applications. However, it is often preferable to contact your local solar shop and have your own array built locally based on your exact needs.

 **Warning! Never connect a solar panel directly to the E-Sampler power input! Never connect the E-Sampler to a solar power kit without first connecting the batteries to the solar kit! Immediate over-voltage damage to the E-Sampler circuit boards can result!**

Solar panels output a high DC voltage during sunlight hours; beyond their nominal voltage. Even a solar charge controller may output higher voltages if not connected to a battery. A bank of external batteries is always required when using a solar array, to ensure function during the night and cloudy weather. The solar panels must be wired to charge these batteries through an appropriate

charge controller. The E-Sampler runs off of the solar system battery array only. The E-Sampler will only tolerate 10 to 16 VDC input.

The solar power setup will require a 9638 DC battery power cable which plugs into the main power connector on the bottom of the unit. The internal battery (if used) should be removed from the E-Sampler if a solar power kit is to be used.

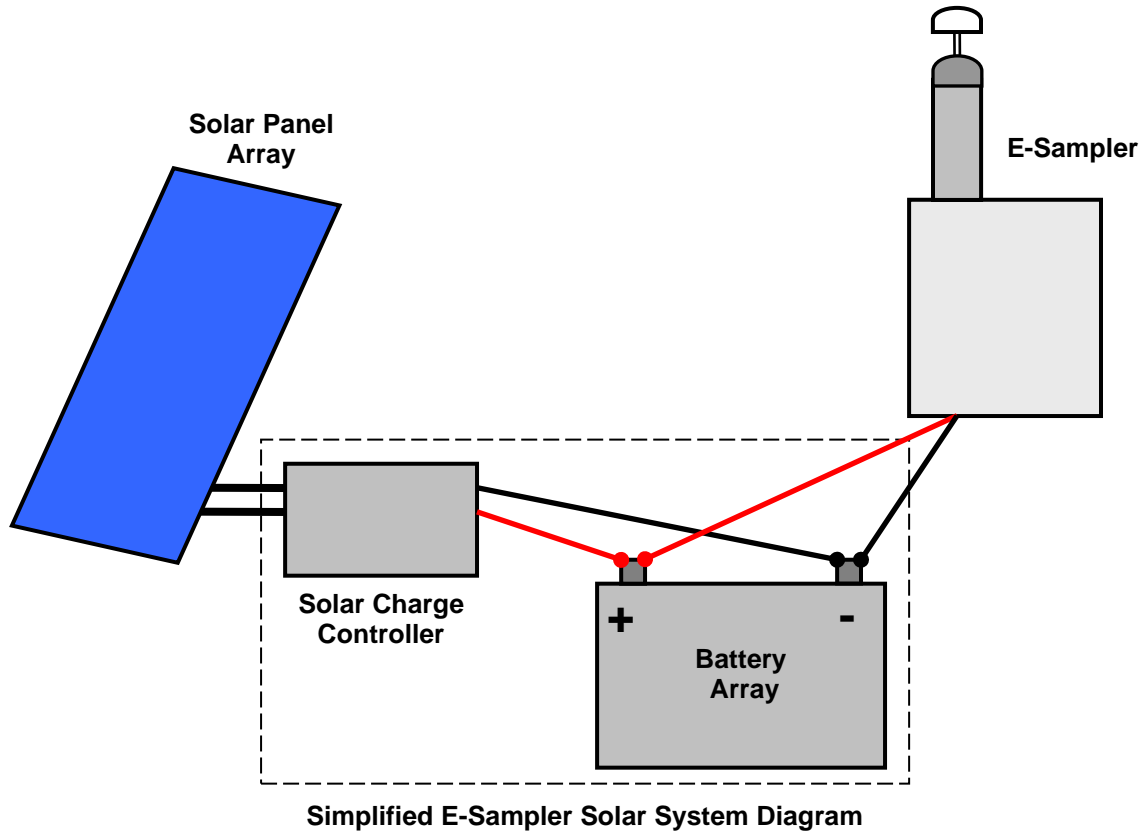

4 E-SAMPLER USER INTERFACE and MENU SYSTEM

This section describes the E-Sampler user interface system, and describes the functions of the main menu options, including how to view data and errors.

4.1 The User Interface - Keypad and Display Functions

The E-Sampler user interface consists of a 4x20 character liquid crystal display (LCD) and a dynamic keypad. The two white keys under the display are called “soft keys”. These are dynamic keys which change in response to a menu option displayed directly above the key on the bottom row of the display. The function of these keys depends on which menu is shown on the display, and are often used for functions such as “SAVE” and “EXIT”.

The four red arrow (cursor) keys are used to scroll up, down, left, and right, to navigate in the menu system, and to select items or change fields on the screen. The arrow keys are also often used to change parameters or increment/decrement values in the menu system. The right arrow key can be used to wake up the display if it has turned off to save power.

The MENU/SELECT key is used to enter the main menu or to select an item in a list. The ESC key is used to escape or exit out of a menu.

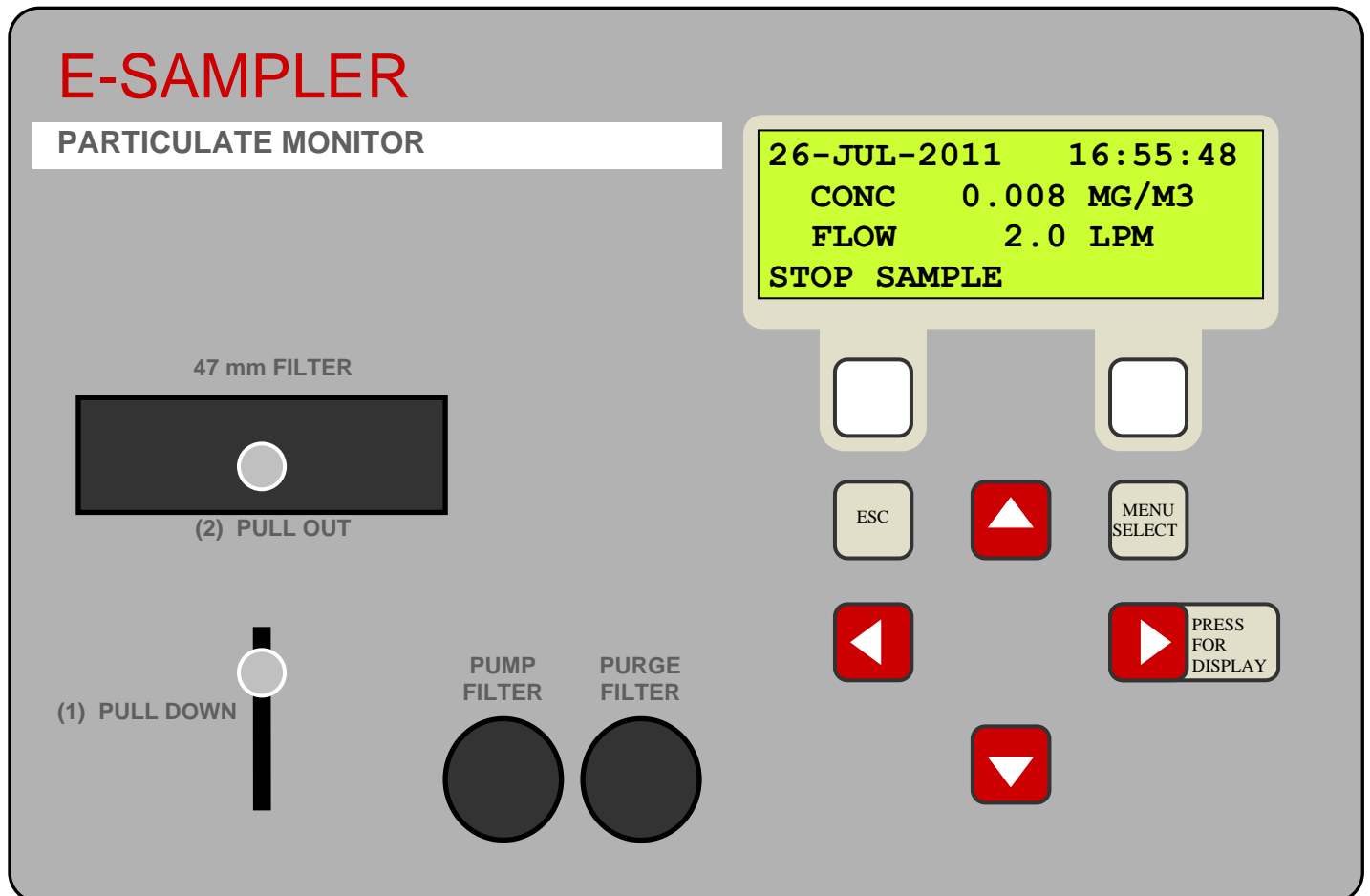

E-Sampler User Interface and Front Panel

4.2 Using the Main Sampling Screen

The E-Sampler display shows the Sampling screen when the unit is in normal operation. The active display area shows the current date and time, the 1-second real-time concentration, and the current flow rate. Also shown is the STOP SAMPLE indicator for the left soft key. To view the rest of the instantaneous sensor parameters which do not all fit on the display at once, press the down ▼ arrow. The date and time will remain at the top of the display at all times.

To view past data, use the left ◀ arrow key to scroll back to previous data records. There will be one complete data record for every real-time average interval, indicated by the time/data stamp at the top of the screen. For example, if the real-time average is set to 10 minutes, then there will be a complete data record stored every 10 minutes as shown below. Again, you can use the ▼ key to view the rest of the sensor parameters for that record. Press the ESC key at any time to return to the current concentration sampling screen.

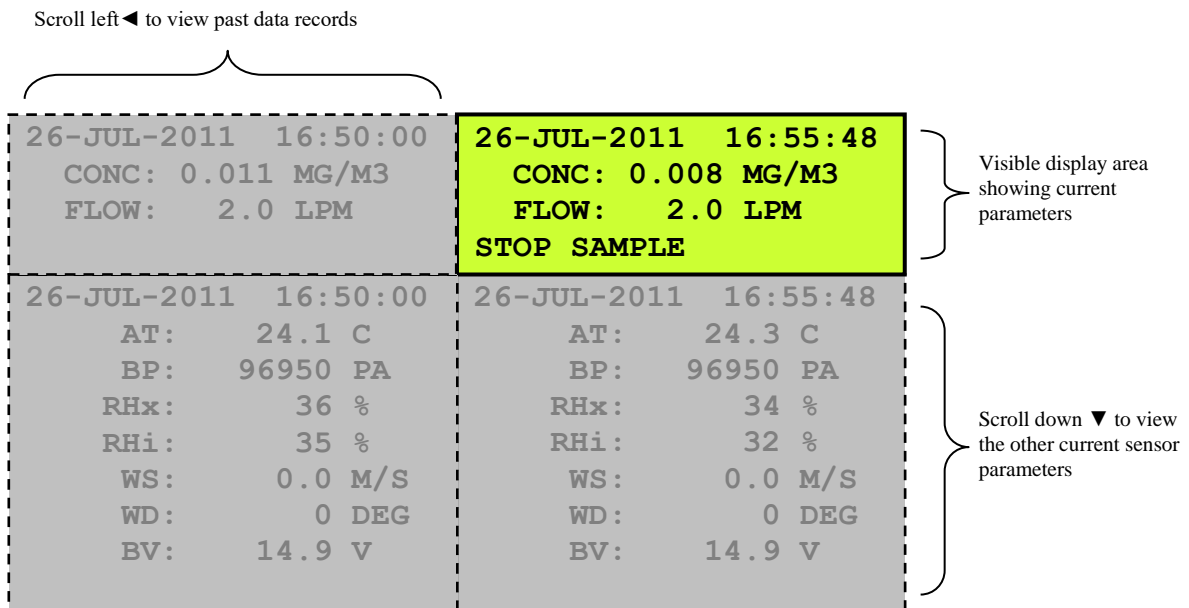

Main Sampling Screen Format

Below is a table which describes the parameters visible in the main sampling display as shown above. These are all of the logged parameters in the E-Sampler. The active display shows the 1-second real-time value for each parameter, while the stored data shows the average value over the user-selected logging interval.

Parameter	Description
CONC	Real-time particulate concentration, in milligrams per cubic meter.
FLOW	Real-time sample flow rate, in actual liters per minute.
AT	Ambient temperature in degrees C.
BP	Ambient barometric pressure in Pascals.
RHx	External ambient relative humidity (if equipped).
RHi	Internal filter sample relative humidity.
WS	Wind speed in meters per second (if equipped).
WD	Wind direction in degrees (if equipped).
BV	Battery voltage (or DC input voltage).

4.3 Using the Main E-Sampler Menu System and Clearing Memory

The main E-Sampler menu system can be entered at almost any time by pressing the MENU/SELECT key. Use the ▲ ▼ arrow keys to select the desired menu option, then press the MENU/SELECT key to enter the selected sub-menu. The functions in the SETUP and CALIBRATE menus are described in Section 6 and 7. All of the other main menu functions are described below.

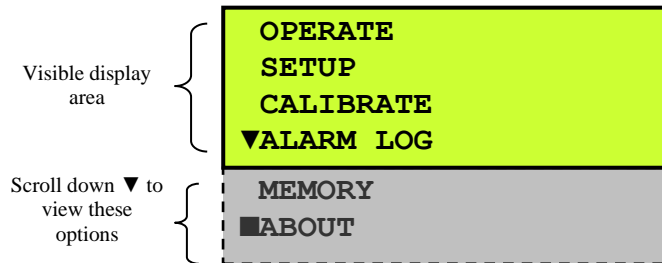

The Main E-Sampler menu

OPERATE: This menu option puts the E-Sampler into normal operation screen where a new sample can be started. If the unit is already sampling, this option will simply exit the main menu and display the main sampling screen.

SETUP: This is the setup menu for the E-Sampler. All of the setup parameters in this menu are described in Section 6.

CALIBRATE: This is the field calibration menu for the E-Sampler. All of the calibrations and tests in this menu are described in Section 7.

ALARM LOG: This menu option allows you to quickly view the error log entries in the E-Sampler without having to download the digital data. The screen will display the type of error, as well as the time and date when the error occurred. Scroll through the error records using the ◀▶ arrow keys. Press the MENU/SELECT key to return to the main menu. See Section 8.1 for a description of the possible error and alarm types.

MEMORY: This menu option displays the amount of memory left in the E-Sampler digital data system as shown below. To erase the memory, press the CLEAR key. Use the arrow keys to select either the DATA LOGGER or ALARM LOG, then press the CLEAR key again. The unit will show a CAUTION screen. If you are sure you want to erase the selected log, press the YES key.

CAUTION! Once the data log or the error log is cleared, the data can never be recovered.

```

MEMORY
 99 % REMAINING
 30.3 DAYS REMAINING
CLEAR                               EXIT
    
```

```

CLEAR MEMORY
CLEAR:▼DATA LOGGER
CLEAR                               EXIT
    
```

```

>>>> CAUTION <<<<
CLEAR DATA LOGGER
      MEMORY?
NO                               YES
    
```

ABOUT: This menu option displays the E-Sampler firmware version and revision as shown in the example below. The up/down arrow keys may be pressed to change which firmware version is shown. The E-Sampler has two separate firmware files. One is for the master CPU and the other is for the 3610 I/O control board. Press the MENU/SELECT key to return to the main menu.

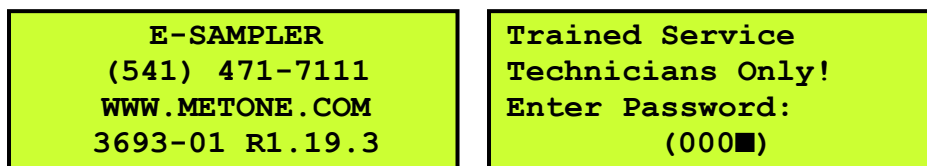

Note: If the ESC key is pressed while the E-Sampler is displaying the ABOUT screen, the unit will prompt the user for a password. This is for entry into an advanced factory test menu. Do not enter this system unless instructed to do so by a Met One technician.

5 E-SAMPLER MEASUREMENT METHOD

The Met One Instruments, Inc model E-SAMPLER is a type of nephelometer which automatically measures and records real-time airborne PM_{10} , $PM_{2.5}$, PM_1 or TSP particulate concentration levels using the principle of forward laser light scatter. In addition, the E-SAMPLER has a built-in 47mm filter sampler which can optionally be used to collect the particulate for subsequent gravimetric mass or laboratory evaluation. The E-Sampler combines the excellent real-time response of a nephelometer with the accuracy and traceability of a manual gravimetric sampler. This section describes the measurement systems.

5.1 Forward Laser Light Scatter Nephelometer System

Sample air is drawn into the E-Sampler by an internal diaphragm pump. The flow rate is controlled based on actual conditions for accurate cut-points through sharp-cut cyclones, and to accurately determine the sampled volume.

This sample air is drawn through the MD laser optical module or “laser engine”, where an internal visible laser diode beam is collimated and directed through the sample air stream. The particulate in the sample air stream scatters the laser light through reflective and refractive properties. This scattered light is collected onto a silicon photodiode detector at a near-forward angle, and the resulting electronic signal is processed to determine a continuous, real-time measurement of airborne particulate mass.

The forward light scatter method allows for a more accurate total mass estimate compared to right-angle light scatter, which is better suited for counting and sizing individual particles. Met One also manufactures a complete line of right angle particle counters.

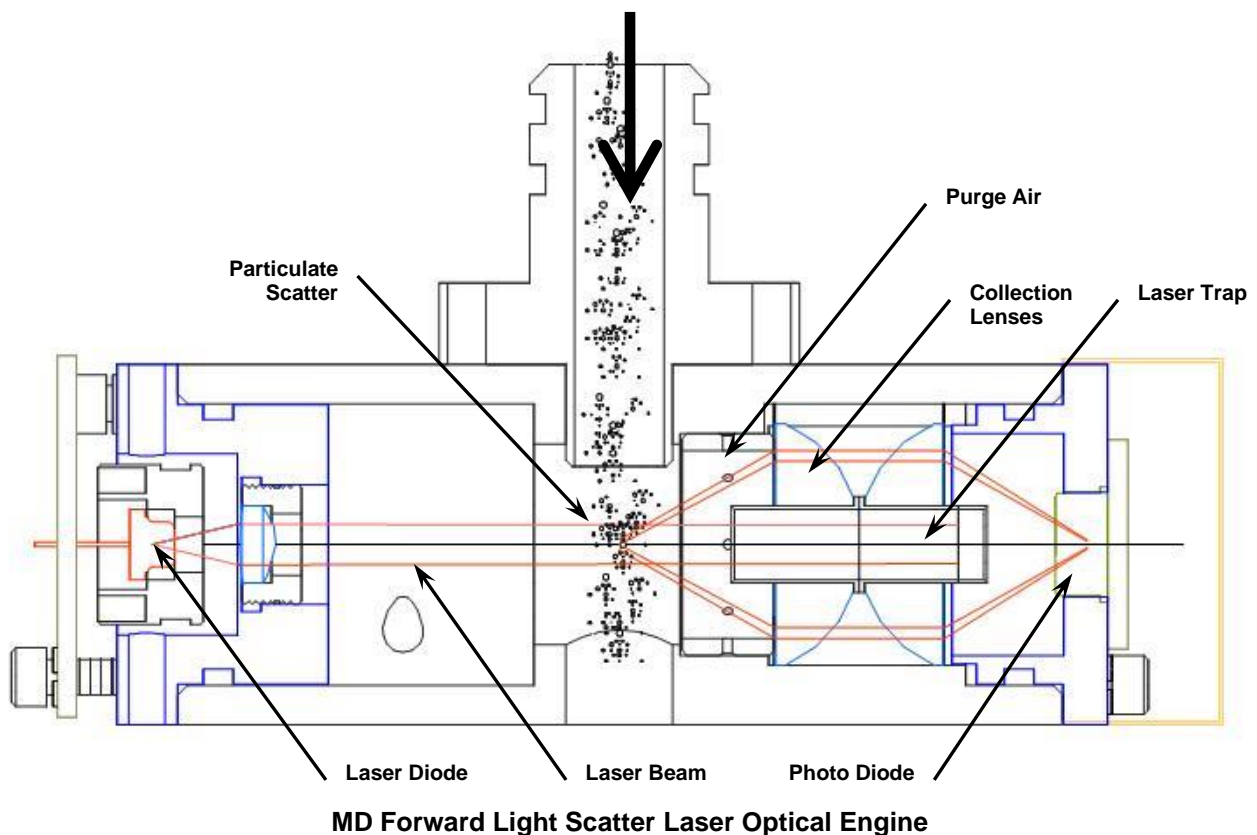

Forty detector measurements are made and averaged into an updated concentration value each second. These 1-second values are temperature compensated using a factory-set algorithm, and averaged into the user-selected data storage interval of 1, 5, 10, 15, or 30 minutes. The 1-second values are also displayed on the LCD and available on the analog output.

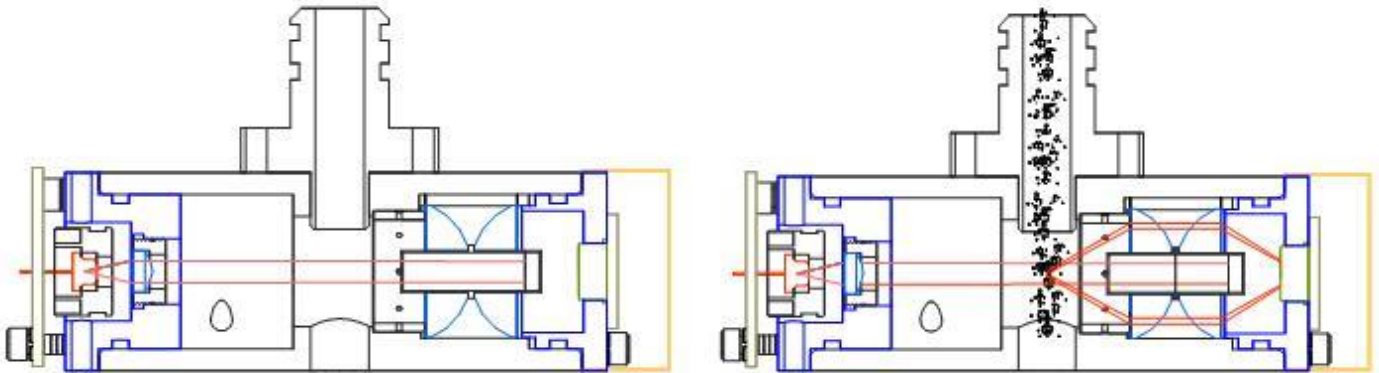

Clean air and particulate scatter conditions in the MD engine

Sample RH Control for Light Scatter Mass

The relative humidity (RH) of the sample air has an influence upon the measurement of particulate mass by nephelometers. At RH values greater than about 50% this effect begins to increase due to particle aggregation and particle size increases as water is absorbed. The E-Sampler mitigates this through a heated inlet tube that uses an internal sample RH sensor. The RH of the incoming air is measured and the inlet heater is turned on whenever the user-set setpoint is exceeded (typically 50% RH). See Section 6.6.

A study in *Atmospheric Environment* showed that RH can drastically effect the concentration measurement as shown in the graph below from Volume 34, pp 4829-4838, 2000. The following article references also contain related information:

Volume 35, Issue 30, Oct 2001:

- Aerosol Light Scattering Measurements as a Function of Relative Humidity. (Malm, Day).
- Diurnal and Seasonal Patterns in Light Scattering, Extinction, and Relative Humidity. (Malm, Gebhart, Copeland).

Volume 35, Issue 16, June 2001:

- Estimates of Aerosol Species Scattering Characteristics as a Function of Relative Humidity. (Malm, Day).

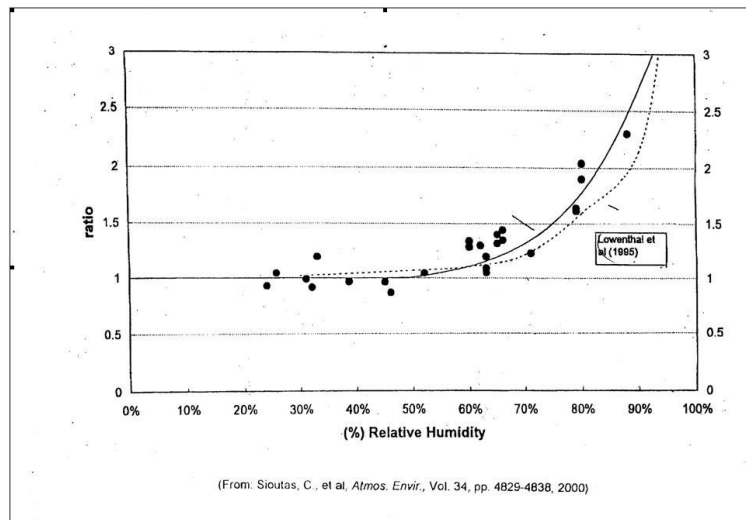

Automatic Zero and Span Self-Tests for the Optical System

To assure stable concentration data, the E-Sampler performs optical system zero and span self-tests at a user-selected periodic rate of 15 minutes, 1 hour, 2 hours, 12 hours, or 24 hours. See Section 6.7.

A separate zero air pump activates and circulates clean air through the optical system. The E-Sampler filters the air through a 0.2-micron pore size, 99.99% efficient filter element before it enters the sensor. This is the PURGE FILTER located in the front panel of the instrument. The E-Sampler zeros itself based on this clean air condition.

Next, the E-Sampler activates a solenoid shutter which allows a small amount of laser light from the light trap to feed back into the detector using fiber optics. This span level is used to check the response of the detector and related electronics. See Section 8 for zero/span alarm logic.

5.2 47mm Gravimetric Filter Collection System

After the sample air stream has been measured by the E-Sampler and exits the MD optical engine, it passes through the built-in 47mm filter sampler system. This system allows the particulate to be collected as a second method to obtain airborne particulate mass data, or for laboratory analysis of the particulate.

This is a low-flow version of the manual sampler gravimetric method, which is the standard measurement technique against which all continuous methods are compared in the U.S. and most other countries, since it is very accurate and yields repeatable data.

The filter material used in the 47 mm system can be selected based upon the desired type of laboratory analysis, or an empty filter cartridge can be installed to use the E-Sampler as a real-time instrument only, without collecting any dust samples.

Note: At least an empty filter cassette must be installed in the E-Sampler at all times, in order to seal the flow system!

A main use for the filter collection system is to establish a slope correction multiplier to correct the E-Sampler real-time concentration output. The procedure for generating the K-Factor is described below in Section 5.5.

Selecting 47 mm Filter Material

47 mm filter discs of various materials and pore sizes can be selected depending on the desired laboratory analysis. These filters are made by companies such as Whatman www.whatman.com and Millipore www.millipore.com among others. Met One generally does not supply the filter discs. The following table gives some basic usage overview for different filter mediums. Additional research and material considerations will be required depending on your application:

Filter Medium	Applications
Polycarbonate	SEM analysis, epifluorescent microscopy, reflective light microscopy, asbestos monitoring, chemotaxis, parasitology, cytology.
Nylon	bioassays, particle analysis
Medical Grade PVC	silica analysis, black carbon or quartz particulates
Quartz Fiber	gravimetric, heavy metals
Glass Fiber	general purpose PM ₁₀ and PM _{2.5} gravimetric
PTFE	EPA standard for PM _{2.5} FRM gravimetric samplers



The 47 mm Filter Cassette and Filter Tray

5.3 The Airflow Control System Diagram and Description

The flow control system is an integral component of the E-Sampler. A complete description is included to assist the user in understanding the E-Sampler flow system:

1. Ambient air is drawn in through the TSP inlet and the PM₁₀, PM_{2.5} or PM₁ cyclone (if used) at 2.0 lpm. This flow rate is used because the cut-point of the cyclones is dependent on the velocity of the particles and is only accurate at the rated flow rate.
2. The sample air goes through the vertical inlet tube, which is heated if necessary to keep the sample air humidity below 50% RH to prevent measurement errors caused by moisture.
3. The sample air stream immediately enters the laser optical module where it passes through the laser beam and the particulate is measured.
4. The sample air passes through the 47 mm filter cassette holder, where all of the particulate is deposited onto the 47 mm filter disc (if used). If no filter disc is used, the air passes through the filter backing perforated screen disc in the empty cartridge. The sample RH sensor is located in the top of the filter cartridge receiver.
5. The pump filter removes any particles larger than 5 microns to protect the flow sensor and pump. The air stream then passes through the flow meter which measures the mass flow rate of the sample air as an analog electronic signal which is sent to the CPU where the ambient temperature and pressure are used to calculate the actual flow.
6. Down-stream of the flow meter, a pulsation chamber is used to reduce the pressure pulsations caused by the diaphragm pump, which would otherwise appear as noise in the flow sensor signal. There is nothing inside the pulsation chamber.
7. The air is drawn into the vacuum side of the main sample pump. This is a brushless diaphragm pump which is pulse-width modulated (PWM) by the CPU to control the flow rate.
8. Most of the sample air exhausts through the pump to the exhaust fitting on the bottom of the E-Sampler. A small amount (about 10%) of the pump exhaust is recirculated through a simple purge adjust valve (T-fitting with a screw installed in one of the ports). This purge adjust is factory-set to control the ratio of the purge air, and should not be tampered with.
9. The purge air passes through the purge filter which removes any remaining particles larger than 0.2 microns in size, then passes through the open manual purge shutoff valve. The purge air enters the laser optical module in a ring around the detector lenses, and through a port in front of the laser focus lens. The clean air circulating past the lenses greatly reduces the amount of dirty sample air which would otherwise contact and contaminate the optics.

Note: The purge shutoff valve must be open during normal operation! If left closed during sampling, the purge-air system will be disabled and the optics will get dirty much faster. The valve is located in the battery compartment, and is closed by the operator during leak checks.

- During the zero portion of the automatic periodic self-test cycle, the main sample pump is turned off and the purge pump is turned on. The air is filtered by the purge filter and circulated through the laser module at a higher flow rate. The air in the laser module is 100% filtered during this process, and no scattered light should enter the detector. The E-Sampler takes a zero reading and established a new signal baseline. A check valve prevents air from back-flowing through the purge pump during normal sampling.

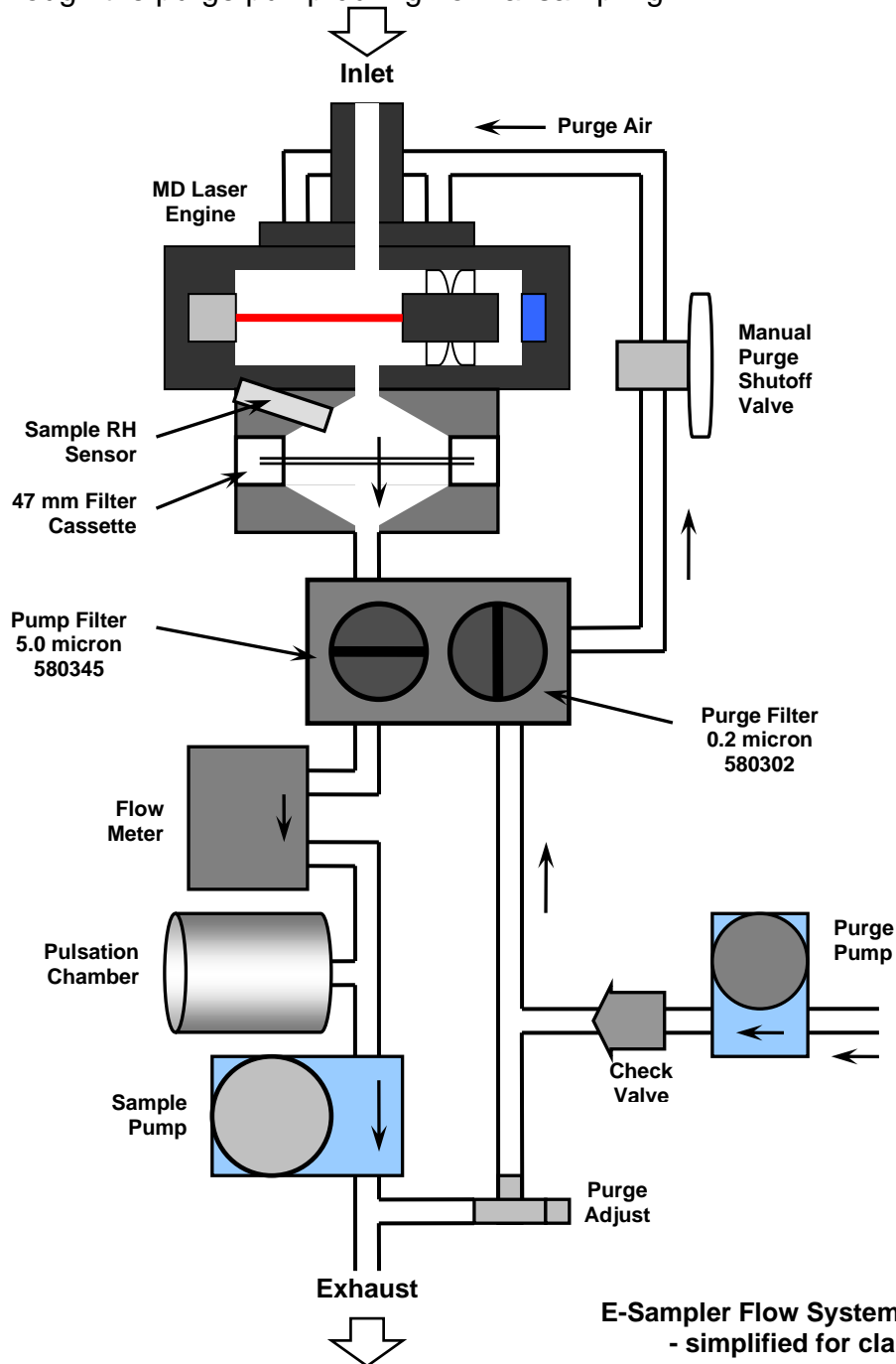

5.4 Timed Operation and Scheduled Sampling Events

The E-Sampler can be set to TIMED operation mode whenever a scheduled sampling event with a user-defined start time and duration is needed. This mode is usually used when a 47 mm filter is installed in the E-Sampler for a fixed amount of time, such as when performing a 24-hour filter samples similar to an FRM, when running an E-Sampler along with a collocated instrument with synchronized sample periods, or when creating a K-Factor using the filter collection method. Timed mode may also be used whenever the E-Sampler is set up early with a future start time to save power.

Only one timed event can be scheduled at a time. The SETUP > SAMPLING MODE screen is used to enable TIMED operation, and to set the start time and duration of the event. Also see Section 6.4.

27-JUL-2011 11:59:59 CONC: UNIT OFF FLOW: 0.0 LPM TIMED	27-JUL-2011 12:00:20 CONC: 0.005 MG/M3 FLOW: 2.0 LPM TIMED	STARTED: 27-JUL-2011 12:00:00 REMAIN: 00-23:59:40 STOP SAMPLE EXIT
--	---	---

The OPERATE Screen and TIMED STATUS Screen

When waiting for a scheduled event, the E-Sampler main OPERATE screen will display UNIT OFF for the CONC value as shown above left. Once a timed event has started, the E-Sampler will show the current concentration and flow rate as shown above middle. The TIMED soft-key can be pressed to view to the TIMED STATUS screen with the start time and the remaining countdown time for the event as shown above right. The STOP SAMPLE soft key can be used to stop the event if needed. The EXIT or ESC keys return to the main OPERATE screen.

5.5 Establishing a Gravimetric Correction K-Factor for the E-Sampler

The main limitation of most nephelometer instruments is that the accuracy of the mass output can be negatively affected by variations in size, color, shape, and index of refraction of the sampled particles. One of the most important uses for the 47 mm filter system is determination of a gravimetric K-factor (slope multiplier) to correct the E-Sampler signal to compensate for local particulate characteristics.

A gravimetric K-Factor MUST be generated for the E-Sampler if accurate concentration measurements and good agreements with FRM or FEM methods are expected. In some applications the appropriate K-Factor will be quite significant, such as a multiplier of 3 or 4 or even more. Once determined, the K-Factor will generally remain valid for that unit and site as long as the particulate type is consistent. The E-Sampler can be used with no correction factor (K=1) in applications where relative particulate trending is appropriate.

A filter disc is carefully weighed on a microbalance scale under laboratory conditions, then placed into the E-Sampler filter holder and run for a predetermined period of time. The filter is then reweighed in the lab, and the resulting total mass of the dust on the filter is correlated with the volume of air sampled, and compared with the concentrations that the E-Sampler recorded over the same time period, then a correction factor is calculated:

1. **Download and save all E-Sampler data before changing the K-Factor setting!** When the K-Factor value is changed, it will apply to any previous data already stored in memory.

2. Obtain and/or pre-weigh the 47 mm disc filters on a microbalance scale according to standard protocol. Pre-weighed filters are often obtained from an outside lab due to the expense of the scale and lab setup. See 40 CFR Part 50 for more information, or contact a reputable lab. Many agencies already have appropriate filters for use in reference method filter samplers on hand. Met One recommends using PTFE/Teflon filters.
3. Install and check the E-Sampler. Make sure that the sampling site is representative of the local air. Use FRM/FEM siting criteria whenever possible. See Section 3. Make sure that the E-Sampler passes all leak checks and flow calibrations.
4. Determine the length of the sampling period. For good gravimetric results, there should be about 0.5 mg (500 µg) of mass deposited on the filter if possible. The time it takes to accumulate this amount of dust will vary greatly depending how clean or dirty the air is. In normal ambient air at moderate concentrations, you will usually need to run the E-Sampler for about 4 or 5 days.

If the typical average daily concentration levels at the site are known, then you can calculate the required run time based on the known value. You could also make a rough estimate by running the E-Sampler for a day, then download the real-time data and calculate the average in mg/m³ over the period.

For example, the E-Sampler draws 0.12 cubic meters per hour (at 2.0 LPM). If the average daily concentration at the site is about 0.035 mg/m³, and you want .5 mg on the filter, then:

$$0.035 \text{ mg/m}^3 * 0.12 \text{ m}^3/\text{hr} = \mathbf{0.0042 \text{ mg/hr}}$$

$$0.500 \text{ mg} / 0.0042 \text{ mg/hr} = \mathbf{119 \text{ hours } (\approx 5 \text{ days})}$$

5. Set the E-Sampler to TIMED sampling mode, and set the event duration to the estimated amount of time determined in step 3, or a similar convenient interval. Install the 47 mm filter and run the timed sample.
6. After the sample period has ended, remove the 47 mm filter and have it re-weighed in the lab. The filter must be handled carefully, transported carefully, and equilibrated properly.
7. Download the E-Sampler light scatter data and average the E-Sampler concentration data values for the entire sample period.
8. Evaluate the E-Sampler total flow over the sample period. First, check the flow values in the downloaded data for proper 2.0 lpm regulation. The E-Sampler data does not record the sample volume, so you must calculate it. If the E-Sampler ran for five days (120 hours), then the nominal sample volume would be 2.0 lpm, times 60 min/hr, times 120 hours. This equals 14,400 liters or 14.4 cubic meters of nominal sample volume.

However, you must also compensate for the fact that the sample stops for about 2.8 minutes each time the automatic self-test ran during the timed sample. For example: If the E-Sampler was set to hourly self-test, then 2.8 minutes of each hour would not have flow going through the 47 mm filter. This amounts to 2.0 lpm times 2.8 minutes, or 5.6 liters of air per hour. So if the sample ran for five days (120 hours), then 5.6 liters per hour times 120 hours equals 672 liters. The corrected total sample volume would then be 14,400 – 672 = 13,728 liters, or 13.728 cubic meters. **Note:** 1 cubic meter equals 1000 cubic liters.

9. Use the change in mass results from the gravimetric filter analysis (the difference between the clean and dirty filter weight in mg) and the total sample flow volume (m³) through the filter to calculate the concentration of particulate on the 47 mm filter in mg/m³. The concentration is calculated as total mass divided by total sample volume.

For example, if the clean filter weighed 77.643 mg and the dirty filter weighed 78.345 mg, then the total particulate mass on the filter would be 78.345 minus 77.643, or 0.702 mg. If the total sample volume was 13.728 cubic meters, then the filter total concentration would be 0.702 mg divided by 13.728 m³, or 0.051 mg/m³.

- Calculate the K-Factor as the 47 mm filter total concentration divided by the E-Sampler total light scatter concentration. For example, if the filter total concentration was 0.051 mg/m³ and the E-Sampler total concentration was 0.038 mg/m³, then the K-Factor would be 0.051 divided by 0.038 or 1.342.

Program the calculated K-Factor into the E-Sampler SETUP > CONCENTRATION menu. See Section 7.3. **The E-Sampler will multiply all stored and subsequent concentration measurements by the K-Factor.** The resulting corrected concentrations are stored in memory, shown on the LCD, and scaled on the analog output.

Example Overview:

E-Sampler Sample Event Time:	120 Hours (5 days)
E-Sampler Flow Rate:	120 liters per hour (2.0 lpm) (0.12 m ³ /hr)
E-Sampler Self Test Interval (no flow):	Hourly (2.8 minutes per hour)
Self Test Flow Correction:	-5.6 Liters per hour (-672 liters over 5 days)
E-Sampler Total Sample Flow Volume:	13.728 cubic meters
Clean 47 mm Filter Weight:	77.643 mg
Dirty 47 mm Filter Weight:	78.345 mg
47 mm Total Particulate Mass:	0.702 mg
47 mm Filter Total Concentration:	0.051 mg/m³
E-Sampler Light Scatter Avg Concentration:	0.038 mg/m³
Calculated K-Factor:	1.342

6 SETUP MENU DESCRIPTIONS

The E-Sampler has a system of setup menus which contain all of the settings and parameters needed to perform the measurement and operation of the unit. Many of these settings are set at factory default values which are correct for most applications, but may be altered by the operator to suit the specific needs of your monitoring program. This section describes the SETUP menu in detail, and should be reviewed to ensure desired operation. Once set, most of the values in the SETUP menus will not need to be changed by the site operator. The settings will not be lost if the unit is unplugged or powered down.

The SETUP menu is located in the main E-Sampler menu. Use the arrow keys to select SETUP option in the main menu, then press the MENU/SELECT key to enter the menu. Use the ▲▼ keys to select the desired sub-menu and press the SELECT key again to enter. The top SETUP menu is shown below:

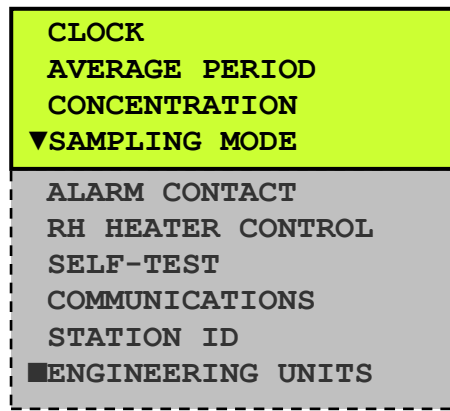

6.1 The CLOCK Setup Screen

The SETUP > CLOCK menu is used to change the date or time. The current date/time is shown at the top of the screen. Use the arrow keys to change the bottom values, then press SET. The menu will exit automatically. Press EXIT to leave the screen without changes.

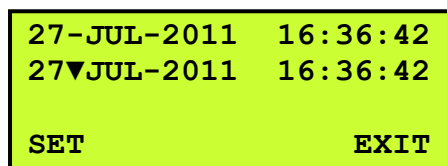

6.2 The AVERAGE PERIOD Setup Screen – Data Logging Interval

The SETUP > AVERAGE PERIOD screen is used to change the averaging period and data logging interval for the concentration measurements and all of the other sensor parameters logged by the E-Sampler. The average can be set to 60, 30, 15, 10, 5, or 1 minute. Modify the settings with the ▲▼ keys and press SAVE. Press EXIT to go back to the setup menu without making changes.

```

AVG PERIOD:▼ 1 MIN
SAVE                EXIT

```

Although the E-Sampler measures the particulate concentration and updates the display each second, the fastest average period that can be logged in memory is 1 minute. The 1 second concentration can be output and logged externally using the E-Sampler analog output.

Because the E-Sampler is a nephelometer, the faster concentration averages are much more useful than the fast concentration averages of the Met One E-BAM beta attenuation unit. For this reason, the E-Sampler is often the best choice for fast-response monitoring of 1 or 5 minute averages, especially where wind/particulate correlations are desired.

Note: The unit contains memory for **4369** data records. The memory will fill up faster the shorter the average interval is set to, as shown in the table below. If the real-time average is set to 60 minutes, the memory will last 182 days before getting full. If a 1 minute real-time average is selected, the memory will be filled up in just three days. When the memory is full, the unit overwrites the oldest data.

Real-Time Average Setting	Records Stored Per Hour	Memory Capacity (Days)
1 min	60	3.03
5 min	12	15.1
10 min	6	30.3
15 min	4	45.5
30 min	2	91
60 min	1	182

6.3 The CONCENTRATION Setup Screen – Range and Scaling

The SETUP > CONCENTRATION screen is used to set the scaling of the concentration measurements. Use the ◀▶ keys to select the desired value, and the ▼ key to change the value. Press SAVE to save the changes or EXIT to leave without changes.

```

RANGE: 0-65 MG/M3
CONC UNITS:▼MG/M3
K-FACTOR: 01.000
SAVE                EXIT

```

The RANGE value is the full-scale range of the E-Sampler analog output. Units with firmware R2.0.0 and later have a fixed range value of 65mg, with a separate analog range setting in the communications setup screen, Section 6.8.

Note: Earlier firmware allowed the range to be set to 0.5, 1, 10, or 65 mg/m³, and setting the RANGE to a higher setting would reduce the resolution of the analog output, since the output voltage was spread over the range of the instrument. However, the E-Sampler digital data system was always auto-ranging, and this old setting did not affect the 65mg digital range or resolution of the unit.

The CONC UNITS setting establishes whether the concentration values are stored in memory in units of milligrams per cubic meter (mg/m³) or micrograms per cubic meter (µg/m³). This setting only affects the position of the decimal point in the data. It does not affect the resolution, accuracy, or scaling of the measurements.

The K-FACTOR setting is the user-set slope correction multiplier which is applied to all concentration measurements. This is used to correct the E-Sampler concentration readings to compensate for mass errors caused by variations in the characteristics of the local particulate.

Note: The K-Factor should only be changed in response to a careful comparison test using the built-in E-Sampler gravimetric filter system, or to match a collocated FRM or FEM particulate instrument. See section 5.5 for details about how to establish a K-Factor.

Typical determined K-Factor values for normal air may vary largely depending on particulate type. The factor can be set to any value between 0.1 and 10.0. If a local K-Factor is not established, leave the value set to 1.000 and the raw concentrations will not be effected (multiplier of 1). Use a K-Factor of 1.000 whenever relative concentrations are appropriate for the application.

6.4 The SAMPLING MODE Setup Screen – Continuous or Timed Sampling

The SETUP > SAMPLING MODE screen is used to set the E-Sampler for either CONTINUOUS or TIMED sampling operation. Use the arrow keys and SAVE key to select the desired mode.

Continuous operation will cause the instrument to run and log data in an uninterrupted manner, and is often used when real-time concentration data with no filter collection is desired.

Timed operation allows the user to schedule a timed sampling event starting at a specified time, and is often used when a filter sample is to be collected by the instrument in addition to the real-time data collection. If TIMED is selected, the schedule screen will appear as shown below right. Use the arrow keys to set the desired START AT date and time for the event. Use the ► key to move to the DURATION field and use the arrow keys to set the duration for the event in days, hours, and minutes. The duration can be set as high as 99 days, 23 hours, 59 minutes. Be sure to press the SAVE key to save the schedule.

Timed events should be scheduled carefully depending on local concentration levels. The duration needs to be long enough to collect an appropriate amount of dust on the filter, without overloading it and clogging the flow system. Keep in mind that the E-Sampler uses a low 2.0 LPM flow rate.

SAMPLING	
MODE: ▼TIMED	
SAVE	EXIT

START AT:	
27▼JUL-2011	12:00:00
DURATION: 00-23:59	
SAVE	EXIT

6.5 The ALARM CONTACT Setup Screen

The SETUP > ALARM CONTACT screen is used to establish the rules for activating the alarm contact closure relay output of the E-SAMPLER. This contact closure is located on the power input connector, and requires a special power cable with the contact wires routed out. The two contacts are normally closed, and will open when the event is triggered. This can be used to signal an external warning light, logic controller, or logger input to take some action. Select the CONTACT SOURCE or CONTACT TIMING screen as shown below.

The alarm CONTACT SOURCE can be set to ALARM EVENT, AVERAGE, or REAL TIME. Setting ALARM EVENT means that any instrument error or alarm will activate the output. The AVERAGE or REAL TIME setting means that the output will be activated when a preset average period concentration or real-time concentration level is exceeded. The LEVEL setting is the average or real-time concentration threshold that will trigger the alarm, and can be set from 00.001 to 10.000 mg/m³.

The CONTACT TIMING screen is used to set how long the alarm signal is ACTIVE when triggered (1 to 60 seconds) and how much delay time must pass before the alarm can be reactivated again (1 to 60 minutes).

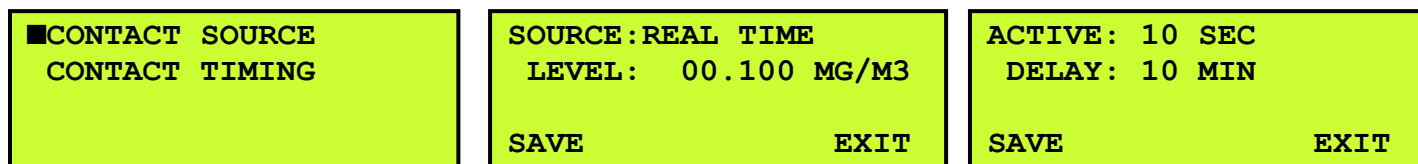

6.6 The RH Control Setup Screen

The SETUP > RH HEATER CONTROL screen is used to set how the inlet heater is used to control the RH of the sample air stream. Use the arrow keys to edit the value, then press SAVE.

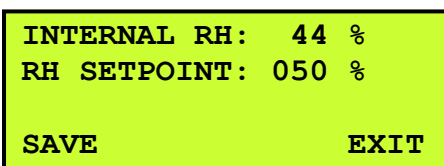

INTERNAL RH is the current reading from the sample RH sensor located in the 47 mm filter holder station. RH SETPOINT is the threshold at which the E-Sampler turns on the inlet heater to limit the RH of the sample air. This can be set from 0 to 100%. When the sample RH exceeds this setpoint, the inlet heater turns on to drive down the relative humidity through mild 10 watt heating. When the RH drops 1% below the setpoint, the heater turns off.

The default setting is 50%, which is adequate for most applications. If the sample RH levels exceed this level, moisture can be absorbed by the particulate and measured as artificial mass. This causes errors in the particulate measurement. A lower set point such as 45% or 35% may be used to further reduce the potential for sample RH effects, although this results in some additional power consumption due to longer heater cycles. For minimum power consumption applications, the RH SETPOINT can be set to 100%, effectively disabling the inlet heater from ever coming on. The inlet heater uses the majority of the E-Sampler total power.

6.7 The SELF-TEST Setup Screen – Zero and Span Settings

The SETUP > SELF-TEST screen is used to set the interval at which the E-Sampler will perform the automatic zero and span tests to verify the optical system. The PERIOD can be set to 15 minutes, 1 hour, 2 hours, 12 hours, or 24 hours. The self-test takes up to three minutes. The zero test circulates clean filtered air through the optical system to establish a baseline signal. The span test feeds a small amount of laser light back into the detector to check the detector response.

Setting the self-test PERIOD to faster intervals is sometimes useful in high concentrations, but the routine interrupts normal sampling, and uses additional power for the zero pump and the span solenoid. Set the period to longer intervals in clean air and for low power applications. The SPAN CHECK value allows you to disable the span portion of the self-test routine if desired.

```
SELF-TEST
PERIOD:▼ 24 HR
SPAN CHECK: YES
SAVE                               EXIT
```

6.8 The COMMUNICATION Setup Screen

The SETUP > COMMUNICATION screen is used to set the analog voltage and serial port baud rate. Use the arrow keys to edit the values, then press SAVE.

The RANGE setting in this screen is rarely used and only applies to the analog output scaling. For the best analog resolution, this setting should be set to the concentration lowest range likely to be encountered. The E-Sampler digital range is fixed at 65 mg/m³.

The DAC RANGE is the full-scale voltage of the analog output, and can be set to 1.0, 2.5, or 5.0 volts for external data logger compatibility. Rarely used.

The BAUD RATE setting is for the E-Sampler digital RS-232 serial port. The baud rate can be set to 300, 600, 1200, 2400, 4800, 9600, 19200, or 38400. The 9600 baud setting is the default and is adequate for many applications. Use 38400 baud for large file downloads whenever possible.

Note: When a computer is connected to the E-Sampler for digital data retrieval, it will need to be set to the same baud rate as the E-Sampler or serial communication will not occur.

```
RANGE: 0-0.5 MG/M3
DAC RANGE: 1.0 VOLT
BAUD RATE: 9600
SAVE                               EXIT
```

6.9 The STATION ID Setup Screen

The STATION ID is similar to a “unit ID” or “location ID” value used in other instruments. This value will appear in the E-Sampler data array. Use a unique ID number for each unit in your network, so that collected data can be correlated to a specific site or E-Sampler. The STATION ID can be set to any value from 0001 to 9999.

6.10 The ENGINEERING UNITS Setup Screen

The SETUP > ENGINEERING UNITS screen sets the conventions for reporting the temperature, pressure, and wind speed parameters. It can be set to METRIC or ENGLISH. The METRIC setting is used in almost all applications. METRIC reports in Celsius, Pascals, and meters per second. ENGLISH reports in Fahrenheit, inches of mercury, and miles per hour.

7 CALIBRATE MENU – FIELD CALIBRATIONS

The E-Sampler has a system of calibration menus which allow the operator to audit or calibrate the airflow control system parameters for optimal performance. These parameters are often audited monthly and calibrated quarterly during continuous operation. The exact frequency may vary depending on the harshness of the local conditions and the data validation requirements established by the sampling program administrator and your resulting standard operating procedures (SOP).

Note: *The E-Sampler temperature, pressure, and leak status should always be checked before any flow calibrations are performed, since the flow calculation is dependent on these parameters.*

The CALIBRATE menu is located in the main E-Sampler menu. Use the arrow keys to select CALIBRATE option in the main menu, then press the MENU/SELECT key to enter the menu. Use the ▲ ▼ keys to select the desired sub-menu and press the SELECT key again to enter. The top CALIBRATE menu is shown below:

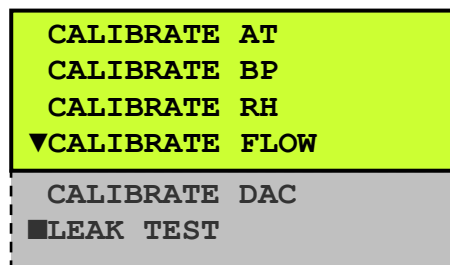

7.1 Ambient Temperature Calibration

The CALIBRATE AT screen is used for field audits or calibrations of the ambient temperature measurement of the E-Sampler.

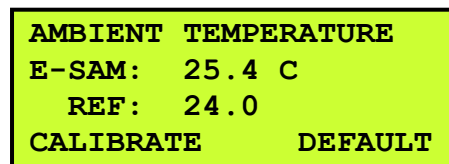

The E-SAM parameter is the current reading from the E-Sampler temperature sensor. The REF parameter is where you can enter the correct value from your traceable temperature standard, using the arrow keys. The E-SAM value should change to match the REF value when you press the CALIBRATE soft key.

The DEFAULT soft key can be pressed to clear out all previous field calibrations and restore the factory calibration for the sensor. Use this if difficulty is encountered during the calibration. Press ESC to escape without changes.

Note: The E-Sampler ambient temperature sensor is an unshielded thermistor bead located in the bottom of the enclosure, and as such is not particularly accurate compared to solar shielded or aspirated sensors. An accuracy of ± 2 degrees C is adequate for flow control purposes.

7.2 Ambient Pressure Calibration

The CALIBRATE BP screen is used for field audits or calibrations of the ambient barometric pressure measurement of the E-Sampler.

```
BAROMETRIC PRESSURE
E-SAM:  97263 PA
REF:    98000 PA
CALIBRATE      DEFAULT
```

The E-SAM parameter is the current reading from the E-Sampler pressure sensor. The REF parameter is where you can enter the correct value from your traceable pressure standard, using the arrow keys. You will need to convert units if your standard outputs pressure in other units. The E-SAM value should change to match the REF value when you press the CALIBRATE soft key.

The DEFAULT soft key can be pressed to clear out all previous field calibrations and restore the factory calibration for the sensor. Use this if difficulty is encountered during the calibration. Press ESC to escape without changes.

7.3 External RH Sensor Calibration

The CALIBRATE RH screen is used for field audits or calibrations of the optional EX-593 external relative humidity measurement of the E-Sampler.

```
RELATIVE HUMIDITY
E-SAM:  47 %
REF:    50 %
CALIBRATE      DEFAULT
```

The E-SAM parameter is the current reading from the E-Sampler external RH sensor. The REF parameter is where you can enter the correct value from your traceable humidity standard, using the arrow keys. The E-SAM value should change to match the REF value when you press the CALIBRATE soft key.

The DEFAULT soft key can be pressed to clear out all previous field calibrations and restore the factory calibration for the sensor. Use this if difficulty is encountered during the calibration. Press ESC to escape without changes.

 **Note:** *This calibration screen does not apply to the internal E-Sampler filter RH sensor, which is located inside the top of the 47 mm filter cartridge receiver. The internal sensor can be audited by checking the RH_i value in the main operate screen during operation. See Section 4.2. The internal RH sensor cannot be calibrated. If the E-Sampler has been operating with the inlet heater running, the inside temperature of the unit will be hotter than ambient, resulting in internal RH readings that will be lower than an ambient RH standard. If the sample RH sensor is to be audited, make sure that the inlet heater is off and the unit has equilibrated to ambient conditions first. If the internal RH sensor fails, it will usually read an impossible value such as 125% or -25%.*

7.4 Flow Sensor Calibration

The CALIBRATE FLOW screen is used for field audits or calibrations of the sample flow measurement of the E-Sampler. Remove the TSP inlet and any cyclones from the E-Sampler inlet tube, and then connect the top of inlet tube to the outlet of your traceable flow meter using a length of appropriate flexible tubing. The E-Sampler temperature, pressure, and leak status must be checked before performing any flow calibrations in order to prevent errors. The E-Sampler flow rate should be maintained to within ± 0.1 LPM (1.9 to 2.1 LPM) for proper air volume total calculation when used with a 47 mm filter, and for proper cut-point performance of inlet cyclones.

```
SETPOINT: 2.0 LPM
E-SAM: 2.0 LPM
REF: 2.0 LPM
CALIBRATE      DEFAULT
```

The SETPOINT parameter is the target flow rate that the E-Sampler will attempt to regulate to.

The E-SAM parameter is the current reading from the E-Sampler flow sensor, in actual volumetric liters per minute. The E-Sampler should automatically regulate to the setpoint (2.0 LPM) when the flow calibration screen is entered. This may take a moment.

The REF parameter is where you can enter the correct value from your traceable flow meter, using the arrow keys. **The flow reading that you enter must be in actual conditions.** The E-SAM value should change to match the REF value when you press the CALIBRATE soft key.

The DEFAULT soft key can be pressed to clear out all previous field calibrations and restore the factory calibration for the sensor. Use this if difficulty is encountered during the calibration. Press ESC to escape without changes.

Note: To audit the E-Sampler flow rate without changing the calibration, simply compare the E-SAM value to your traceable standard and record the results. If the CALIBRATE soft-key is not pressed, then no flow calibrations are affected.

7.5 DAC Calibration – Analog Output Adjustment

The CALIBRATE DAC screen is used for field audits or calibrations of the E-Sampler digital-to-analog converter (DAC) output. The output voltage is only available on the communications connector using a special cable with the analog output wires split out. This output is rarely used.

```
MODE: ▼AUDIT
SETPT: 0.500 V
EXIT
```

```
MODE: ▼LOW
OUTPUT: 0.010 V
ADJUST: 0.000 V
SAVE      DEFAULT
```

```
MODE: ▼HIGH
OUTPUT: 0.990 V
ADJUST: 0.000 V
SAVE      DEFAULT
```

The MODE can be set to AUDIT, LOW, or HIGH using the ▼ key as shown above. In AUDIT mode, you can force the analog voltage to any voltage from 0.000 up to the full-scale voltage (1.000, 2.500, or 5.000 volts). Compare the displayed value to the actual voltage measured on the analog output using a volt meter, and record the results. The actual voltage measured on the E-Sampler analog output wires must match this setting within ± 0.001 volts. If not, the analog output on the E-Sampler will need to be adjusted.

In the HIGH mode, the analog output is forced to 10 mV below the full-scale voltage of the unit (0.990 volts if set to 1.000V scale). Measure the actual voltage output of the E-Sampler, and if it does not match, the ADJUST field can be set (using the arrow keys) to adjust the voltage up or down by as much as 0.100 volts. Be sure to SAVE any changes.

In the LOW mode, the analog output is forced to 0.010 volts. Measure the actual voltage output again and make any adjustments. The LOW mode can only be adjusted from -0.016 to 0.100 volts. After the HIGH and LOW modes are adjusted and saved, go back to the AUDIT mode and make sure that several voltage points from zero to full-scale now match your voltmeter within ± 0.001 volts.

Note: Only a high quality voltmeter should be used for this test. Cheap voltmeters usually do not give accurate measurements at millivolt levels. The E-Sampler analog output should also be checked with the external datalogger connected, in order to make sure that the logger or cables are not affecting the voltage.

7.6 Leak Test Calibration Checks

The CALIBRATE > LEAK CHECK screen is used to check for airflow system leaks which could affect the accuracy of the flow measurements, or cause unwanted measurement biases.

STEP 1 CAP OFF INLET NEXT	STEP 2 CLOSE PURGE VALVE NEXT	STEP 4 LEAK TEST: PASS FLOW: 0.0 LPM NEXT
--	--	--

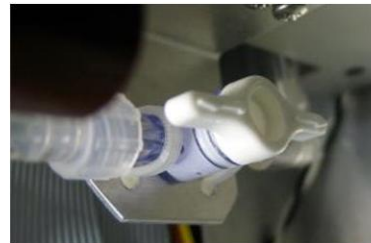

Purge valve closed (Left) and open (Right). Located inside the battery compartment

1. Remove TSP inlet and sharp cut cyclone. Cap off the top of the E-Sampler inlet tube with a vinyl or rubber cap.
2. Open the front door and remove the battery cover plate. Locate the purge cutoff valve on the left side. Rotate it to the closed position as shown above.
3. Wait for the system to zero the flow sensor reading. This step is omitted if steps 1 and 2 take longer than the zero flow sensor process (~25 seconds). The software will automatically proceed to the step 4 when the zero flow sensor process has completed.
4. The pump is turned on. Wait for flow reading to stabilize (about 2 minutes). The leak test will be OK if the reading is less than 0.3 liters-per-minute. The leak test will FAIL if the reading is greater than 0.3 liters-per-minute. Do not run this test for more than 5 minutes because it will reduce the lifetime of the pump motor.
5. The pump is turned off. Rotate the purge cutoff valve back to the open position as shown. Remove the vinyl cap from inlet and re-install the sharp cut cyclone.

8 MAINTENANCE and TROUBLESHOOTING

This section provides information about routine maintenance of the E-Sampler, and for performing more detailed diagnostic tests if a problem is encountered. The E-Sampler generates error messages on the display or in the data log if a failure or other problem is detected. Many times there is a simple solution. Persistent errors often signify a failure which will require investigation.

The E-Sampler is an extremely component-dense assembly! Only skilled and trained electro-mechanical technicians should attempt any disassembly or repairs inside the E-Sampler. Routine maintenance procedures do not involve removing the E-Sampler assembly from the enclosure.

8.1 E-Sampler Alarm Displays, Alarm Logs, and Alarm Codes

The E-Sampler contains a comprehensive system of error and alarm codes which are used to alert the operator to any problems with the unit. These error codes may be generated during normal operation or during a self-test routine. The errors appear on the E-Sampler display, and are also stored in the digital alarm log as a detailed record of the time and type of the error. In addition, errors are stored in the digital data log as a code number in the data array.

The following table describes each of the error and alarm types which can be generated by the E-Sampler, along with the conditions which cause the alarms. Many of these alarms indicate critical parameters which must be working correctly for machine operation.

Alarm/Error Message	Alarm Description
POWER OUTAGE	This alarm message indicates that the E-Sampler power has been cycled off and then back on. This can mean that there was a power failure or that someone simply unplugged the unit to turn it off. The E-Sampler alarm display will show OFF time indicating how long the power was off, and ON time indicating how long the power was on before the power failure. A second type of power alarm can be shown on the display as a COP RESET. This means "Computer Operating Properly", and will only occur when the E-Sampler firmware is flash updated by the user. This is normal and does not indicate a failure.
INTERNAL COMM DOWN!	This alarm indicates that there was an internal SPI bus failure, preventing the CPU from communicating with the I/O board for 10 seconds or more. The time and date of the error will be displayed. The E-Sampler will stop operation until internal communication is restored. If these errors occur regularly you will need to contact Met One.
LASER FAILURE	Refer to the Laser Current Logic section. Occurs when the MD engine laser current is out of range. The alarm is cleared when the laser current is within range.
ZERO CALIBRATE ERROR	Refer to the Self-Test Event logic section. Occurs during the Self-Test event when the MD engine output is out of range. The alarm is cleared when the next event does not fail.
ZERO STABILITY ERROR	Refer to the Self-Test logic section. Occurs during the Self-Test event when the MD engine output stability is out of range. The alarm is cleared when the next event does not fail.
PRESSURE FAILED	This occurs when communication is lost to the digital pressure sensor. A failed pressure sensor is forced to read 101306 Pa or 29.9 inHg.
FLOW FAILED	This alarm indicates that the flow system is more than 5% out of regulation for more than 5 minutes. The alarm display will show the actual flow rate and the time and date of the error.
BATTERY WARNING or BATTERY FAILED	The BATTERY WARNING occurs if the input voltage drops below 11.2 volts and clears when the voltage restores to above 11.7 volts. BATTERY FAILED occurs if the voltage drops below 10.5 volts and clears when the voltage restores to above 11.7 volts. The time and date of the error will be displayed, along with the actual voltage.
DETECTOR ERROR	Refer to the Self-Test Event logic. Occurs during the Self-Test event when the MD engine output is out of range. The alarm is cleared when the next event does not fail.
SOLENOID ERROR	Refer to the Self-Test Event logic section. Occurs during the Self-Test event when the MD engine output is out of range. The alarm is cleared when the next event does not fail.

The following are some examples of how the alarm and error records appear when shown on the main E-Sampler display as a current error or, when viewed as a historical error record in the user interface system:

16-DEC-2008 16:25:20 POWER OUTAGE OFF: 0.00:02:10 ON: 5.06:05:31	16-DEC-2008 16:25:20 LASER FAILURE ALARM: 25.0 MA VALUE: 26.3 MA	16-DEC-2008 16:25:20 FLOW FAILED FLOW: 1.4 LPM
16-DEC-2008 16:25:20 ZERO CALIBRATE ERROR RANGE: 0-10 MG/M3 VALUE: 00.0000 MG/M3	16-DEC-2008 16:25:20 ZERO STABILITY ERROR RANGE: 0-10 MG/M3 VALUE: 00.0000 MG/M3	16-DEC-2008 16:25:20 DETECTOR ERROR RANGE: 0-10 MG/M3 VALUE: 00.0000 MG/M3

The normal E-Sampler digital data array also contains an “alarm” code column to indicate if there were any alarm or error flags during that particular sample period. An example of an E-Sampler data record is shown below. The alarm header and alarm code are highlighted below:

AutoMet Data Log Report 02-AUG-2011 09:25:10, ID,1 SN,M4373
Time, Conc (MG/M3), Flow (l/m), AT (C), BP (PA), RHx (%), RHi (%), WS (M/S), WD (Deg), BV (V), Alarm
02-AUG-2011 09:15:00, 0.023, 2.0, 25.2, 97302, 1, 39, 0.3, 1, 14.2, 0

The following table defines the possible error codes that can appear in the “alarm” column of the E-Sampler data records:

Code	Error/Alarm Type
0	No alarm
1	Self-Test Failure
2	Not Used
4	Laser Current Failure
8	Pressure Sensor Failure
16	Flow Failure
32	Not Used
64	Internal Hardware (SPI bus) Failure
128	Low Battery

Note: If multiple errors or alarms occur in the same data period, then the alarm code stored in the data array will be the *sum of the two individual code numbers*. This is a rare occurrence.

When the digital error log is retrieved from the E-Sampler using Comet software or ESCAPE commands, the error report will contain the same information about the alarms as described above, only in the following format:

```
E-Sampler Alarm Log Report
02-AUG-2011 14:25:26,
SN,M4373
```

```
20-NOV-2008 20:00:00, Power outage: 0.00:20:17 On: 5.02:30:22
20-NOV-2008 20:00:00, Laser Failure: 26.3 mA
20-NOV-2008 20:00:00, Flow failed: Setpt: 2.0 Flow: 1.4
20-NOV-2008 20:00:00, Low battery: 9.46
```

In each case, the alarm log record indicates the time and date of the error, and the specific parameter which generated the alarm. The measured value of the parameter, compared to the acceptable limits, is also recorded where applicable.

8.2 Contact Closure Alarm Relay Output

The E-Sampler has a single channel contact closure alarm relay output available. This is used to signal an external datalogger that the E-sampler has encountered an unspecified error. The relay contacts are located on the main E-Sampler power input connector (pins 3 and 4), so you will need a special power cable which has a break-out for the relay wires, as the standard power cables do not. The two relay contacts are normally closed (shorted together) when the E-Sampler is operating correctly, and will open up when an error occurs. The relay is rated for up to 100V_{DC} @ 0.5A max. The relay output is very rarely used.

The only alarm flags which do not activate the relay output are the BATTERY WARNING and POWER OUTAGE.

8.3 Basic Problem and Cause/Solution Table

The following table contains information on some of the more common E-Sampler problems which may be encountered, and some steps to identify and remedy the problems. Met One welcomes customer suggestions for new items to include in this section of future manual revisions. If the solution cannot be found in the following table, then contact one of our expert service technicians for help in resolving your problem.

Problem:	The E-Sampler won't start a measurement cycle.
Cause/Solution:	<ul style="list-style-type: none"> You must press the START SAMPLE key to start continuous operation. If the unit is set for a TIMED sample, it will not start until the scheduled time. The main display will show the TIMED soft key where you can view the schedule. The E-Sampler may not start a measurement cycle if it detects a hardware failure, such as a pressure sensor failure or a pump failure. The unit will not start a cycle if the input DC voltage is below the restart threshold, such as 10 volts DC. The unit will usually display an error message on the display if it cannot start a cycle.
Problem:	Flow failures or low flow.
Cause/Solution:	<ul style="list-style-type: none"> Make sure a 47 mm filter disc has not been installed and forgotten. This will eventually block the flow. Clean the 47 mm filter cartridge backing screen, even if no filter is used. Large particles can plug this screen. Check the PUMP and PURGE filters. These must be replaced periodically.

	<ul style="list-style-type: none"> • Try to DEFAULT the flow sensor calibration. If corrupted flow cal parameters are entered into the flow calibration, it may appear that the flow system is not working. • Check for insect debris or other obstructions in the small exhaust port on the bottom of the unit. It is located in the back right corner. • Verify the AT and BP sensors function. Failed sensors can affect the flow. • The sample pump itself will eventually wear out and need to be replaced. It should last at least a year under normal conditions. Check the other possibilities first.
--	---

Problem:	Leak check failures
Cause/Solution:	<ul style="list-style-type: none"> • Make sure that a 47 mm filter holder cartridge is installed correctly, even if no filter is used. It is required to seal the flow system. • Check or replace the 47 mm filter cartridge itself. Some of these can leak at the interface of the two halves of the assembly. • Make sure that the inlet is completely blocked with a rubber or vinyl cap during the leak check. Using a finger to block the inlet is not sufficient. • Make sure the inlet tube is fully seated into the top of the optical module, especially if you installed the inlet heater assembly yourself. You may need to temporarily loosen the weatherproof fitting at the top of the inlet tube to get it seated correctly. • Make sure the PUMP and PURGE filter holders are tightened fully.

Problem:	Optical system alarms and failures
Cause/Solution:	<ul style="list-style-type: none"> • The E-Sampler must be periodically returned to the factory for optical system cleaning. The period will depend on your particulate levels. • Check the PURGE filter and replace it as needed. • Make sure the manual purge valve (inside the battery compartment) is OPEN (parallel to the tubing) during normal operation. If closed, the unit will still function normally, but no purge air will circulate around the optics to keep them clean! • The laser diode has a finite lifetime which will be reduced at high temperatures. It may eventually fail and need to be replaced at the factory. • Never disassemble the MD laser optical subassembly! • Some users reported problems with the laser shutter span solenoid sticking or failing to activate in cold weather. Met One has changed to a different type of solenoid and control logic for units with R2.0.0 or later firmware (late 2012). Contact Met One if difficulty with the self-test auto span is encountered on an older unit.

Problem:	The E-Sampler data does not match BAM or FRM data at the same site
Cause/Solution:	<ul style="list-style-type: none"> • A K-Factor (multiplier) <u>must</u> be established for good accuracy and correlation to collocated instruments. The K-Factor will sometimes be very significant, such as a multiplier of 3 or 5. See Section 5.5. • The E-Sampler is calibrated on latex 0.6 micron micro-spheres. These provide an extremely consistent calibration, but do not generally match the characteristics of ambient particulate. • The K-Factor is only valid at the same site and for the same particulate type. If the local particulate source changes, the K-Factor may no longer be valid. • The E-Sampler TSP inlet is designed for low winds only. High winds may cause a cut-point in the TSP inlet itself. • Make sure the correct cyclone is used on the E-Sampler. The PM₁₀, PM_{2.5} and PM₁ cyclones look very similar. The cyclone cut point must match the cut point used on any collocated instruments. • Clean the TSP inlet and any cyclones at least monthly. • Check the sample RH data and filter RH sensor operation. High sample RH will cause E-Sampler over-reading. The sensor itself can occasionally fail. • Check the E-Sampler for flow leaks and flow calibration problems. • Check the alarm log for optical system alarms.

8.4 Suggested Periodic Maintenance Intervals

The following table shows the Met One recommended periods for routine maintenance items. Some of these items will need to be performed more or less often depending on the exact characteristics of your location. The program administrator should review these items and establish SOPs appropriate for your application.

Maintenance Item	Suggested Period
System leak check	Monthly
Flow, temperature, and pressure audits or calibration	Monthly
Clean sharp-cut cyclone, particle trap, and TSP inlet	Monthly
Check digital alarm log	Monthly
Clean 47 mm filter holder screen	Monthly
Check filter RH sensors	6 Months
Replace PUMP filter and PURGE filter	12 Months
Factory service, recalibration, and optical system cleaning	24 Months
Replace lithium backup battery, as needed	5 Years

8.5 Sample Pump Replacement

The E-Sampler brushless diaphragm sample pump should last at least 10,000 hours or more than one year during continuous operation. The exact lifetime will depend on how harshness of the sampling environment. The E-Sampler has a second smaller diaphragm purge pump which only runs during the self-test zero period. The current design uses a removable flow system subassembly containing both pumps, the flow sensor, and pulsation chamber. *Before replacing the pump, check all filters and flow system calibrations to make sure the problem is actually the pump module.*

Note: Older E-Samplers had a single reversible rotary-vane pump which performed both the sample and zero purge functions. This design was changed because the old pump was not well suited to some environments. These units have completely different flow system routing, and the following photos and steps will not apply. Upgrades to new style must be performed at the factory.

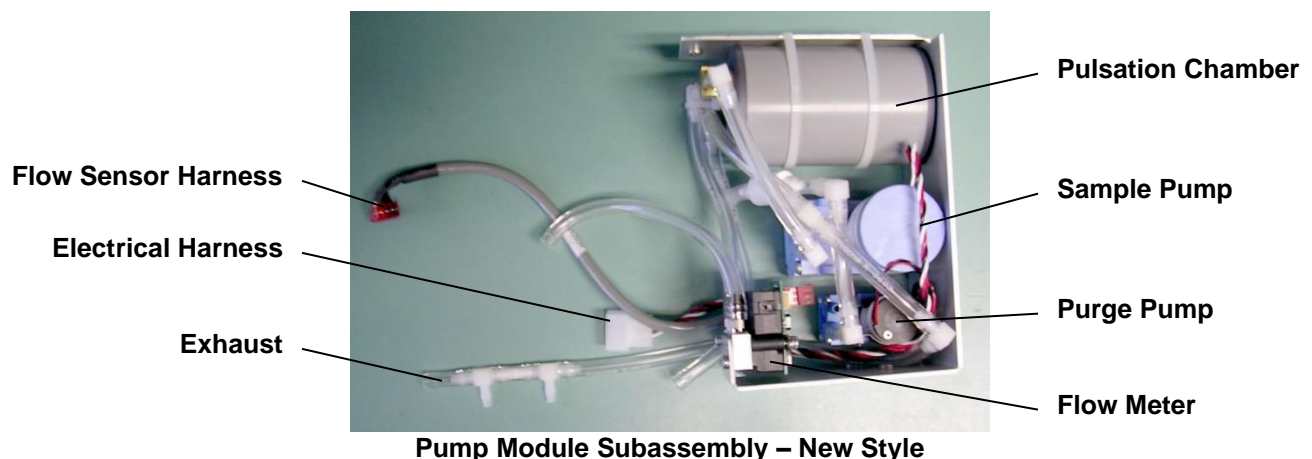

Pump Module Subassembly – New Style

Warning: The E-Sampler is densely assembled, and it can be difficult to service inside. If you are unsure of your technical skills, send the unit in for factory service instead.

1. Disconnect all power from the E-Sampler. Remove the internal battery if used.

2. Remove the inlet heater assembly from the top of the E-Sampler. Remove the three screws from the base of the plastic heater sleeve, then pull the assembly out of the top of the unit. Unplug the heater electrical harness.
3. Unscrew the E-Sampler internal assembly from the enclosure. There are four screws in the front display panel. You will also need to remove the four smaller screws around the connector board in the bottom of the E-Sampler.

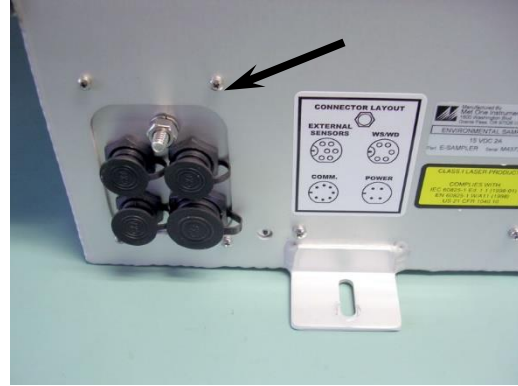

4. Remove the entire E-Sampler internal assembly from the enclosure. You will have to unplug the temperature sensor harness from the PCB, and unplug the exhaust tubing from the exhaust port in the bottom of the enclosure. Note the connector locations.
5. It will be easier to proceed if you unscrew the back panel of the E-Sampler assembly (2 screws), and unscrew the long stand-off support (one flat head screw). This allows the assembly to be opened up slightly.

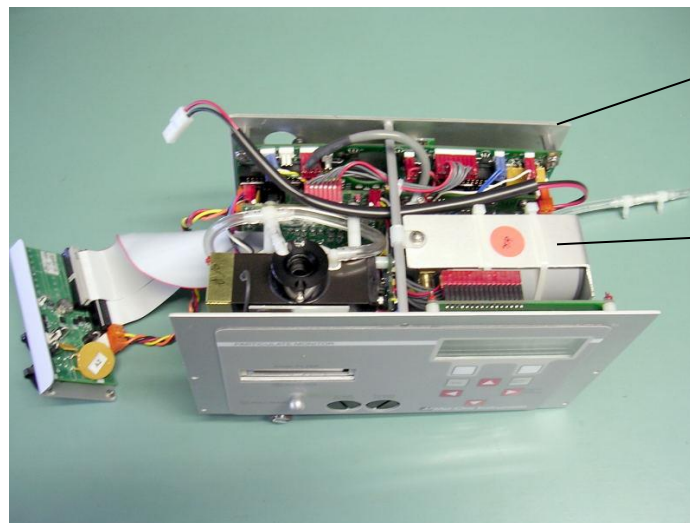

Back Panel
2 screws bottom
1 screw top middle

Pump Module
2 screws bottom
1 screw top plastic clip

6. Unscrew the pump module assembly from the main E-Sampler assembly. There are two screws on the bottom, and one screw through the plastic clip on the top.
7. Unplug the pump module main electrical harness connector, and the flow sensor connector. Unplug the two clear tubes connecting the pump module to the filter block in the E-Sampler. Note which tube goes to which position! You should now be able to remove the pump module. Avoid any further disassembly of the E-Sampler, or unplugging any other connectors.
8. Install the new pump module in the reverse order. Be sure the reconnect all electrical and tubing connections into the correct positions.

9. After reassembly, check for leaks and perform a complete AT, BP, and flow calibration.

8.6 PUMP and PURGE Filter Changes

The E-Sampler PUMP FILTER and PURGE FILTER are the two filter cartridges located in the front panel of the instrument. They can be removed by unscrewing the black aluminum filter holders with a coin using the slot in the face of the holder. The expected lifetime of the two filters is greater than one year, but in heavy particulate areas they may need to be replaced more often.

The 5 micron PUMP filter keeps any large particles from entering the flow sensor or sample pump. The 0.2 micron PURGE filter cleans the recirculated purge air which is used to keep the optics clean during normal operation and the zero self-test. See Section 5.3.

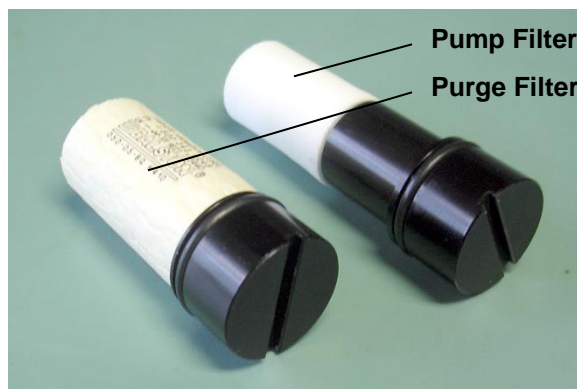

Pump Filter and Purge Filter Replacement

8.7 TSP Inlet and Cyclone Cleaning

All E-Samplers use at least a TSP inlet. In addition to the TSP inlet, sharp-cut cyclones may be used to remove particles greater than the rated cut-point. These inlets need to be periodically cleaned. The time interval between cleanings varies depending on the local particulate levels. Met One recommends cleaning the cyclone particle trap at least once a month. The TSP inlet and cyclone body should be disassembled and cleaned every three months during continuous use.

Clean the cyclone particle trap by unscrewing the knurled cap from the cyclone body, then wipe it out with a cloth or blow it clean with compressed air. Check the o-rings and lubricate if necessary. Full cleaning of the cyclone requires unscrewing the three socket-head Allen screws to access the conical chamber inside. All of the inside surfaces must be cleaned. Isopropyl alcohol and cotton-tipped applicators work well.

The TSP inlet can be disassembled for cleaning by removing the three screws in the cap. Soap and water often work best for cleaning the TSP inlet and debris screen. Do not over-tighten the screws during reassembly or the plastic threads will strip out.

8.8 Factory Service Interval

The E-Sampler needs to be periodically returned to the factory for service and recalibration. The recommended period is typically two years during continuous use. However, some users establish their own interval depending on the harshness of the sampling conditions, particulate levels, and data scrutiny. High concentration operation will often require more frequent factory service.

Factory service primarily consists of optical system cleaning, laser/detector checks, and recalibration. As-found calibration checks can also be requested. Contact the Met One technical service department to schedule E-Sampler service. A Return Authorization (RA) number must be obtained before the unit is returned.

8.9 Operational Logic for Self-Test and Laser/Detector Alarms

18 Nov 2008
E-Sampler Self-Test Logic

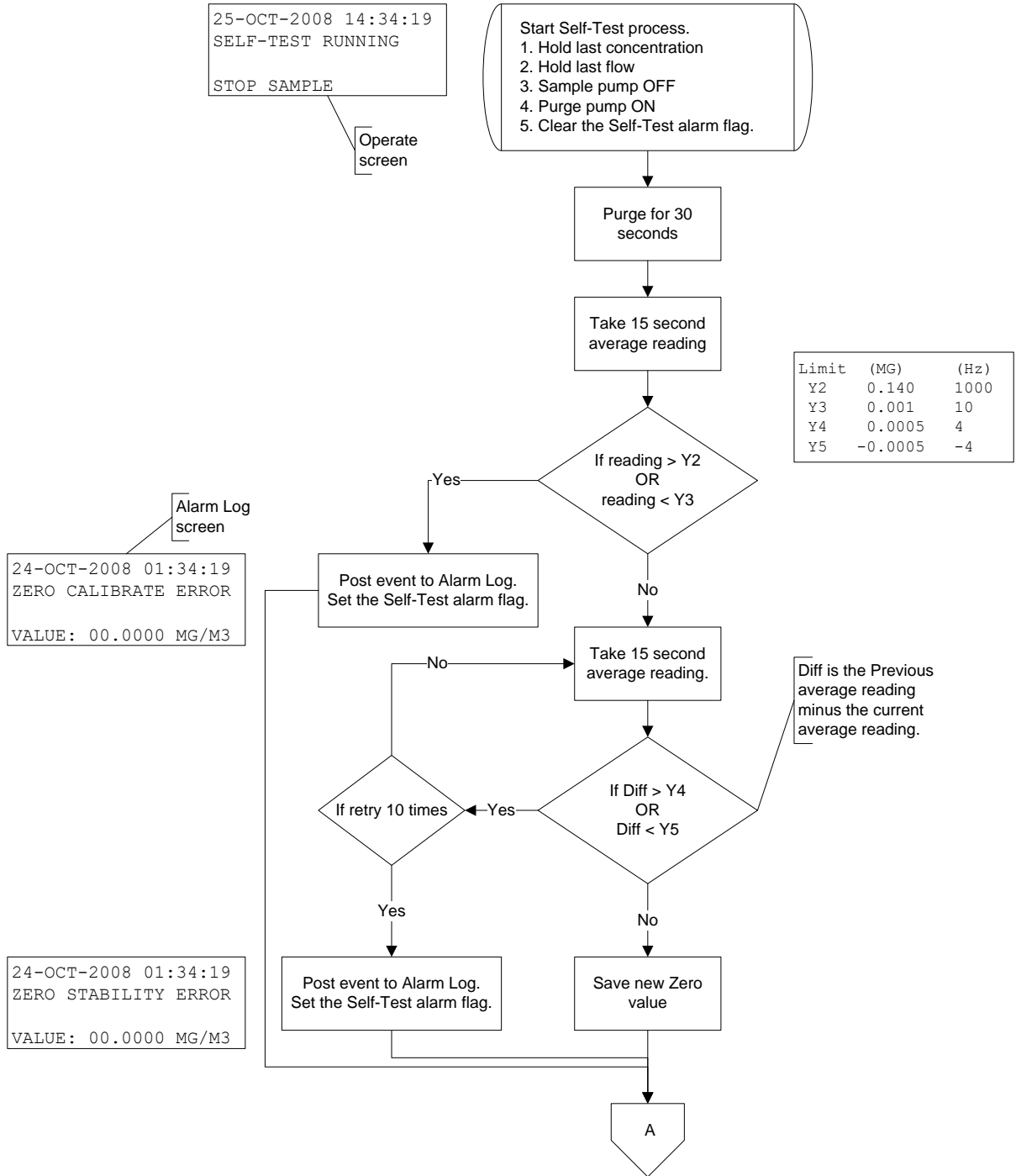

Limit	Y6 (MG)
	Y6 0.200
	Y7 0.005

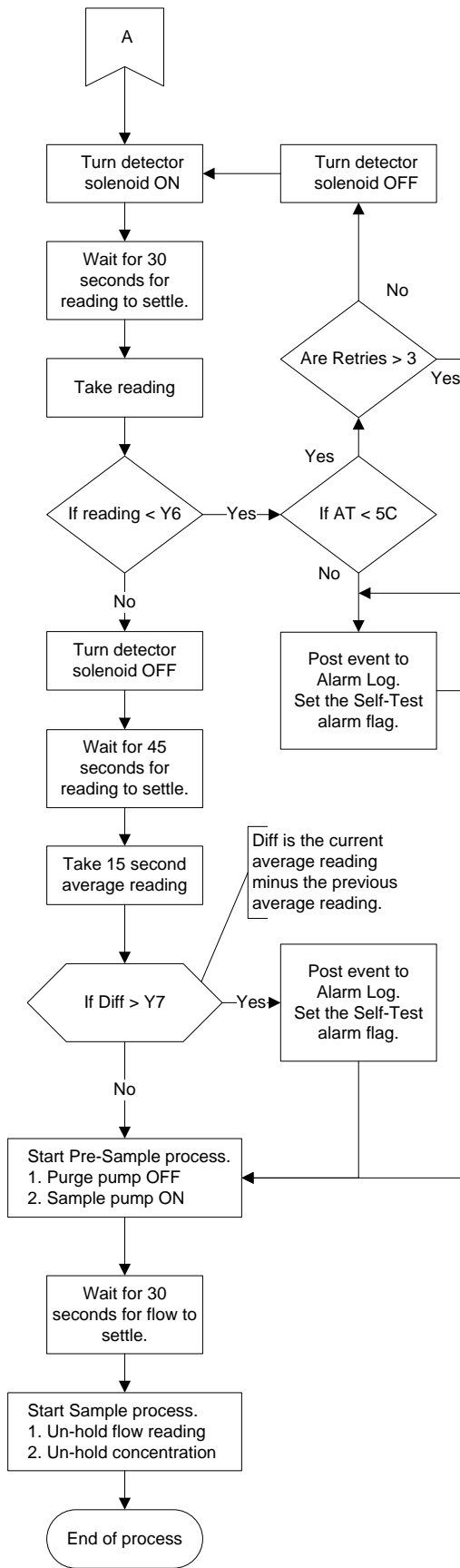

24-JUN-2012 01:34:19
DETECTOR ERROR
VALUE: 00.0000 MG/M3

24-JUN-2012 01:34:19
SOLENOID ERROR
VALUE: 00.0000 MG/M3

Diff is the current average reading minus the previous average reading.

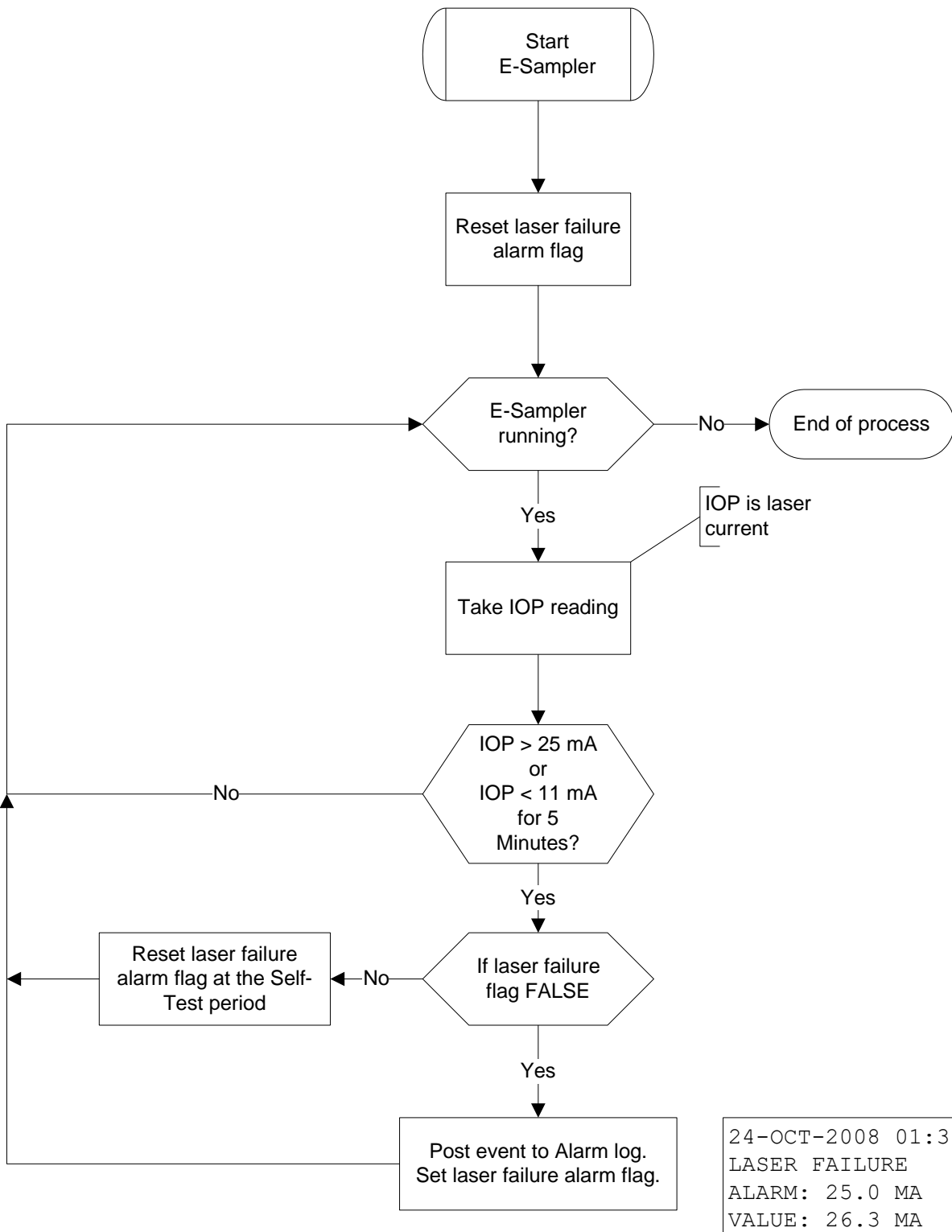

9 DATA RETRIEVAL and COMMUNICATIONS

This section describes the methods used to retrieve data files from the E-Sampler. The unit has an RS-232 two-way serial port which handles all digital data transfer, and may be used with a local computer, laptop, or digital datalogger. The serial port can also be used for remote communications with various modem kits. Access to the data through the serial port is easy using the supplied Comet software or simple terminal or escape commands.

9.1 Analog Voltage Output

The E-Sampler has an analog voltage output available which represents the real-time concentration values. The analog output signal is located on the same connector as the serial data output. The analog output is rarely used because of the portable nature of the E-sampler, so the standard serial cable that comes with the unit does not have access to the analog output signal. If the analog output is to be used, you will need to acquire a special cable which has a breakout for the white voltage output wire (CONC signal) and the black (ground) wire. These two wires are then routed to your analog datalogger input to record the output. The E-Sampler analog output can be set to 0-1, 0-2.5, or 0-5 volts, which represents the user-selected range of concentration. See Section 7.4 for details about how to configure the analog output. See Section 7.5 for instructions about how to test the output voltage.

9.2 Serial Port Connections to a Computer

The E-Sampler can be directly connected through the supplied serial cable to most standard desktop computers that have a 9-pin (DB-9) RS-232 serial port connector (COM 1-4).

The E-Sampler can also be connected to most laptop computers, though newer laptops do not usually have 9-pin serial ports, so a converter may have to be used. The simplest type is a USB-to-RS232 serial adapter. Met One recommends the Belkin F5U109, available from Met One or a local electronics store. You will still need the standard E-Sampler serial cable.

The E-Sampler default settings are 9600 Baud, 8 data bit, no parity, one stop bit. The baud rate may be changed to a faster value. The other communications settings are fixed.

9.3 Modem Options for Remote Data Retrieval

The Met One Instrument EX-996 phone line modem is recommended for use with the E-Sampler, as it is designed to reliably communicate when other modems may not. Other brands of modems must be set in "dumb" or pass-through mode with no handshaking. If you are using one of the Met One Instruments data acquisition programs such as Air Plus, you need only enter the telephone number of the site in the system setup menu of the program. Multiple telephone numbers can be entered for connection to multiple remote sites. See the software manuals.

If you are communicating with a terminal program such as HyperTerminal® you will need to use the terminal program's internal dialing command sequence to dial up the E-Sampler. Verify the connection to the unit by pressing the <Enter> key until the command prompt asterisk (*) appears. If not, verify the cabling and communications settings. Once connected, the access to the E-Sampler is the same command driven interface as used for the direct PC connection.

Cell modems, radio modems, satellite transmitters, and TCP/IP addressable Ethernet modems are also available for the E-Sampler. Because these technologies are always changing, they are handled on a custom basis. Contact Met One for details.

9.4 Comet™ Data Retrieval Software

The E-Sampler is supplied a free copy of the Comet™ program, which is a simple Windows-based communications terminal program developed by Met One Instruments, Inc.. This is the recommended method for all E-Sampler data retrieval, since Comet allows the user to easily download the data logs, error logs, and settings files from the E-Sampler, without having to know any of the underlying communications protocols. The Comet software also contains a very comprehensive pdf user's manual for the program. Install the program onto the computer that you will be using for data retrieval and review the manual for complete data examples.

Note: If you use the Comet software for routine E-Sampler data retrieval, you will not need to use or understand any of the terminal program setups, “AutoMet” commands, or escape commands shown in the rest of this manual subsection.

Warning: A Silicon Labs CP210x Driver for the USB connection must be installed before connecting to the USB Type C port. Driver download weblink:

<https://www.silabs.com/products/development-tools/software/usb-touart-bridge-vcp-drivers>

The Comet program is available from the Met One Instruments website:

<https://metone.com/products/comet/>

Install the program on the computer, then run it from the Programs directory. Create a new nephelometer station for the E-Sampler and then use it to retrieve the data from the E-Sampler monitor.

9.5 Downloading Data Using HyperTerminal

E-Sampler data can also be easily downloaded through the serial port using HyperTerminal® or other simple terminal programs. Most PCs running Microsoft Windows 95® through Windows XP® operating systems already contain the HyperTerminal program. This section describes how to set up HyperTerminal for communication with the E-Sampler:

1. Connect the RS-232 port on the bottom of the E-Sampler to your computer or laptop Com1 serial port using the supplied serial cable. A USB adapter may be required for laptops.
2. Open HyperTerminal. (Usually located in the Programs\Accessories\Communications directory). The program will ask you to type a name for the connection. Type “E-Sampler” or another name of your choice, then click “OK”.
3. The “Connect To” window will open. Select COM1 (or another serial port if used) from the drop-down menu in the “Connect using:” field. Click “OK”. Note: You could also set up the program to dial the E-Sampler through a modem in this window.
4. The “COM1 Properties” window will open. Set the following values in the drop-down menus, then click “Apply” and “OK”.

Bits per second:	9600 (set to match E-Sampler setting)
Data bits:	8
Parity:	None
Stop bits:	1
Flow control:	None

5. The main HyperTerminal connection window should now be open. Press the ENTER (carriage return) key three times. The E-Sampler should respond with an asterisk (*) command prompt indicating that the terminal program has established communication with the unit. Once communication is established, retrieve the desired files from the E-Sampler using the appropriate “AutoMet” ASCII commands shown in the next section. Note: When

using the advanced <ESC> escape commands through a terminal program, you do not need to send asterisks to establish the connection first.

6. HyperTerminal will only display a few lines of data in the window. To capture the files, first select Transfer > Capture Text from the drop-down menu. Select a location for the file, then click the “Start” button. Retrieve the desired files, and HyperTerminal will automatically store them to the text file as they are downloaded. Click the “Stop” button in the same drop-down menu to stop the text capture when finished.
7. When you exit HyperTerminal, it will ask if you want to save your connection. Click “Yes” and a file named “E-Sampler.ht” (or other connection name) will be created in the HyperTerminal folder, which will have all of the communication settings saved. You can use this connection for future communications with the unit.

Importing the raw text file into a spreadsheet:

The data saved in a text file from a terminal download can be viewed by simply opening the text file. However, the data is often hard to view in the raw text format due to the comma-separated layout of the data fields. The easiest way to analyze the data is to import it as a .csv file into a spreadsheet program such as Excel®:

1. Open the text data file, located in the directory you selected for the text capture.
2. Delete all of the unnecessary text rows (menu lists, download date, serial number, etc.) and any empty rows at the top of the file, down to the data header row which defines each of the columns of data. **Do not delete the data header row**, since you will want it to appear in the spreadsheet. There must be no blank spaces or other characters before the data header.
3. Scroll to the end of the data and make sure there are no other files, terminal menus, or empty rows after the last data record. If so, delete them.
4. Save the text file and close it.
5. Rename the file extension from **.txt** to **.csv**. This will change the file from a text file to a “comma-separated values” data file.
6. The .csv file can be opened directly with Excel. Each data parameter should appear in its own spreadsheet column, with the correct data header at the top of each column. You can then save the file as a .xls spreadsheet file if desired.

9.6 “AutoMet” Data Retrieval Commands Through the Serial Port

When a serial connection between the computer terminal program and the E-Sampler has been established, you will have access to the E-Sampler data files by sending the following commands through serial port with keyboard strokes or ASCII characters.

Note: After a few minutes, the E-Sampler will stop waiting for a command and you will have to send another series of three carriage returns to reestablish the command prompt connection.

If you send an “h” character, the E-Sampler will respond with a help menu containing the AutoMet command set descriptions:

```

* E-Sampler Help Menu

2 : Report all AutoMet data
3 : Report new AutoMet data
4 : Report last AutoMet data
? : Report model and firmware version
<Esc>h : <Esc> Help menu
    
```

Command	Function
2	Prints all records in the E-Sampler data log file. This can be a large file!
3	Prints all new records in the E-Sampler data log file, since the last data download.
4	Prints the last record in the data log file only. The newest data array record.
?	Identifies unit firmware info. Example: “E-Sampler 3693-01 R1.19.3”
<Esc>h	Returns the escape command set descriptions. See below.

The following is an example of the data response from the E-Sampler after a “2” command (all data records) was sent to the unit. The report starts with a printout of the time and date of the download, and the station ID and serial number of the E-Sampler. Then a data header row is printed which defines each of the columns in the data field. The columns are separated by commas to make it easy to import the data into a spreadsheet, or to parse out data fields in an automatic data collection system. Each column is a certain data parameter. Each row is one complete data record consisting of all stored parameters.

In this example, the average period is set to 15 minutes, so there was a complete record stored to memory every 15 minutes. Data parameters such as wind speed/direction and external RH will always appear in the data array even if no sensors were connected for those channels. In this example, only a small amount of data was stored in the memory:

```

2

AutoMet Data Log Report
02-AUG-2011 09:22:06,
ID,1
SN,M4373

Time, Conc (MG/M3) , Flow (l/m) , AT (C) , BP (PA) , RHx (%) , RHi (%) , WS (M/S) , WD (Deg) , BV (V) , Alarm
01-AUG-2011 18:15:00,0.008,2.0,26.8,96950,1,39,0.3,1,14.2,0
01-AUG-2011 18:30:00,0.007,2.0,27.2,96969,1,37,0.3,1,14.2,0
01-AUG-2011 18:45:00,0.008,2.0,27.5,96969,1,37,0.3,1,14.2,0
01-AUG-2011 19:00:00,0.010,2.0,27.8,96969,1,36,0.3,1,14.2,0
01-AUG-2011 19:15:00,0.008,2.0,28.0,96969,1,36,0.3,1,14.2,0
    
```

If a “3” command is sent (new data records), the data response from the E-Sampler is formatted the same as shown above, but includes only the data logged since the last time the data was downloaded, based on the position of a data pointer. This command saves time by not retrieving old data that has already been downloaded before. Note: The data pointer for new data can be reset to a different record using an escape command.

If a “4” command is sent (last data record), then the E-Sampler responds with only the latest (newest) data record in memory as shown below. This is often used by digital data loggers which are often programmed to collect data from an array of instruments at frequent intervals:

```

4

AutoMet Data Log Report
02-AUG-2011 09:25:10,
ID,1
SN,M4373

Time, Conc (MG/M3) , Flow (l/m) , AT (C) , BP (PA) , RHx (%) , RHi (%) , WS (M/S) , WD (Deg) , BV (V) , Alarm
02-AUG-2011 09:15:00,0.023,2.0,25.2,97302,1,39,0.3,1,14.2,0

```

The following table defines the E-Sampler data parameters as they appear in the header of any of the AutoMet-style data reports:

Field	Description
Time	Date and time stamp of the data record.
MG/M3	Real-time light scatter average concentration in mg/m3.
Flow (l/m)	Average air flow for the data logging period in actual liters per minute.
AT (C)	Average ambient temperature for the data logging period in °C.
BP (PA)	Average barometric pressure for the data logging period in Pascals.
RHx (%)	Average external RH for the data logging period. (Requires EX-593 option)
RHi (%)	Average sample RH for the data logging period.
WS (m/s)	Average wind speed in meters per second. (Requires EX-034 option)
WD (Deg)	Average wind direction in degrees. (Requires EX-034 option)
BV (V)	Average battery or input voltage in volts.
Alarm	Error code (0 = no errors). See Section 8.1 for error descriptions.

Advanced AutoMet Commands:

In addition to the standard data retrieval ASCII commands, the data system supports some additional advanced commands shown below. Do not use these commands without instruction from a Met One technician:

Command	Function
9	Display AutoMet data pointers (for File 2).
p	Modify modem data pointer.
b	Begin XMODEM download of AutoMet data records (for File 2).
c	Clear AutoMet logger memory (File 2) with password.
d	Set date with password.
t	Set time with password.

9.7 Advanced Communications – Escape Commands

The communications “escape” command set shown in the table below used for advanced data transfer or custom data retrieval software applications. Each command and response string must begin with an Escape character (27, 0x1B) and end with a carriage return (13, 0x0D) and a line feed character (10, 0x0A). An ASCII check sum follows each response (X9999). The hardware protocol is RS-232, 8 data bits, no parity, 1 stop bit.

The E-Sampler supports five data files: The settings file (**E**), the Channel Descriptor file (**1**), the AutoMet data log file (**2**), the Alarm log file (**3**), and the Self-Test data log file (**4**). The lowercase **x** in the following commands specifies one of these five files. File modes can be linear (**L**) or circular (**C**). All files are record based.

Function	Command	Response
Read Model and Version	RV	RV E-Sampler 3693-01 R1.19.0
Read File Info (FCB)	RFI	RFI Then print the FCB.
Read record index.	RFx R	RFx R n L RFx R n C
Read data file starting with absolute record index or the last (-n) records from the current record index.	RFx D n RFx D -n	RFx D n Then XMODEM file transfer
Print File Report starting with absolute record index or the last (-n) records from the current record index.	PFx n PFx -n	PFx n Then print the report.
Stop printing report.	PFS or <enter>	PFS
Clear File Data (x: 2, 3, 4)	WFX C	WFX C
Read Date (mm-dd-yy)	RD	RD 05-10-01
Write Date (mm-dd-yy)	WD 05-10-01	WD 05-10-01
Read Time (hh:mm:ss)	RT	RT 09:08:02
Write Time (hh:mm:ss)	WT 09:08:02	WT 09:08:02

If an <Esc>h command is sent through the E-Sampler serial port, the following escape command help menu will be output. This lists the common escape commands:

```

* E-Sampler <Esc> Help Menu

<Esc>PFE      : Print settings file)
<Esc>PF2 -n   : Print last n-records of AutoMet data
<Esc>PF3 -n   : Print last n-records of Alarm data
<Esc>PF4 -n   : Print last n-records of Self-Test data
<Esc>RV       : Report model and firmware version
<Esc>RD       : Read Date (MM/DD/YY)
<Esc>RT       : Read Time (HH:mm:ss)
<Esc>WD       : Set Date (MM-DD-YY)
<Esc>WT       : Set Time (HH:mm:ss)
<Esc>WFX C    : Clear file x memory
                  x = 2 : AutoMet file
                  x = 3 : Alarm file
                  x = 4 : Self-Test file

```

One of the more useful escape commands is the <Esc>PFE which outputs the E-Sampler settings file as shown below. This is similar to the settings files in the BAM-1020 or E-BAM instruments:

```

E-Sampler EEPROM Report
02-AUG-2011 09:38:24,

      Master:      3693-01 R1.19.3
      Slave:       3694-01 R1.18
      SerialNum:   M4373
      LogPeriod:   900 Sec
      ConcRange:   2 0-10 mg/m3
      DacRange:    0 1.0 V
      K-Factor:    1.000
      SampleMode:  0 CONTINUOUS
      TimeStart:   1312221600 01-AUG-2011 18:00:00
      TimeDur:     43200 Sec
      FlowSetPt:   2.0 LPM
      SelfTestPeriod: 3600 Sec
      Baud:        5 9600
      StationID:   1
      EngrUnits:   1 METRIC
      ConcUnits:   0 MG/M3
      IGain:       700
      PGain:       500
      TempSlope:   -0.00013434
      TempOffset:  1.16106415
      RHSetPt:     50 %
      AlarmSource:  0
      AlarmLevel:  0 mg/m3
      AlarmActive: 10 Sec
      AlarmDelay:  10 Min
  
```

Multi-Drop Network Identification Protocol Using Escape Commands:

E-Sampler firmware R1.19.5 and later has a feature which allows RS-232 serial commands to be addressed to a particular E-Sampler unit, which will be ignored by other E-Samplers on the same serial line. This is primarily intended for use in a system where a central data collection computer with a spread-spectrum radio serial link modem is used to communicate with multiple E-Samplers, in a “one-to-many” wireless RS-232 network. Each E-Sampler in the system needs to be set with a unique LOCATION ID number of between 1 and 99.

The identified command is: <Esc>A99<sp>cmd<cr>.

Command Component	Description
<Esc>	ASCII escape character (0x1B hex, 27 decimal)
A	ASCII character 'A' (0x41 hex, 65 decimal)
99	1 or 2 numeric ASCII characters 0 – 9 (0x30 – 0x39 hex, 48 – 57 decimal). This is the Location ID (1 – 99) set in the E-Sampler unit.
<sp>	ASCII space character (0x20 hex, 32 decimal)
Cmd	The desired AutoMet or <Esc> type command.
<cr>	ASCII carriage return character (0x0D hex, 13 decimal)

The NW command is used to enable the network Identification command address range 1 to 99. The format for enabling is as follows:

<Esc>A0<sp>NW<sp>1<cr>.

The format to disable is as follows:

```
<Esc>A0<sp>NW<sp>0<cr>.
```

Note: The multi-drop network support must be disabled in order for the E-Sampler firmware update utility to operate!

For example, to print all the AutoMet data in the CSV format from a unit with a Location ID of 25, the command string would look like this:

```
<Esc>A25<sp>S<sp>2<cr>
```

Notice that 'S' must preface any AutoMet single character type commands. The Xmodem commands 'b' and 'r' are not allowed.

To print all the AutoMet data in the CSV format from a unit with a Location ID of 25, the command string would look like this:

```
<Esc>A25<sp>PF2<sp>-9999<cr>
```

The Xmodem commands 'WFF' and 'RF' are not allowed.

9.8 Flash Firmware Upgrades





The E-Sampler has the capability for flash firmware upgrades. This allows the field operator to reprogram or update the E-Sampler master flash EEPROM through the serial port using the Firmware Update Utility program. A Met One technician may supply the firmware update files on a CD or by e-mail if a bug fix is released, or if additional features are added to the firmware program. The following tasks must be performed whenever the firmware is upgraded:

1. **Download and save the data log and error log from the E-Sampler before proceeding. These will be cleared from memory during the upgrade process!**
2. Firmware Update Utility is a PC-based utility program which used to update firmware in Met One products equipped with FLASH memory technology. You will need a PC or laptop with an available RS-232 COMM port. Install the Firmware Update Utility program onto the computer by following the prompts after the CD is inserted.
3. Connect the E-Sampler serial port to the computer COMM port (usually COMM 1) with the serial cable that came with the E-Sampler. Note: A special serial cable is required if the separate secondary "slave" firmware file is to be updated.
4. Make sure that the computer and the E-Sampler are both set to the 9600 baud rate.
5. **Take great effort to ensure that the power source to the E-Sampler and the computer will not be interrupted during the update process!** A power interruption may cause the E-Sampler firmware to become inoperative! If this happens the unit will have to be returned to the factory. Be especially careful with laptops and USB serial converters to make sure the serial connection does not come loose for the same reason.
6. Run the Firmware Update Utility. From the computer "Start" menu, go to: Programs/Met One/E-Sampler/E-Sampler Master Program Installer.
7. The program will prompt you for the COMM port number. Enter the number (usually 1) and press ENTER to begin the update.
8. A "Done!" message will be displayed at the end of the update process. Execution time is approximately five to fifteen minutes.
9. The E-Sampler can now be operated with the new firmware.

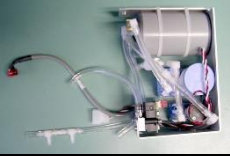

10 ACCESSORIES and PARTS

10.1 Consumables, Replacement Parts, and Accessories

The following parts are available from Met One for maintenance, replacement, service, and upgrades. If unsure about a part you need, please contact the technical service department. Some of these parts may require technical skills or special instructions before use or installation.

Description	Part Number	Graphic
Flow System Components		
Sample Pump Module Assembly	80160	
Flow Sensor, E-Sampler	9049	
Ambient Temperature Thermistor and Harness	9432-1	
Internal Filter RH Sensor	9359	
Purge Filter Holder, Black Aluminum	8912	
Pump Filter Holder, Black Aluminum	8913	
Purge Air Filter, 0.2 micron	580302	
Pump Filter, 5 micron	580345	
O-Ring, For Purge and Pump Filter Holders	720063	
47 mm Filter Cassette, Delrin, With Screen	460128	
47 mm Filters, PTFE, 2 micron, 50 Pack	460137	
47 mm Filters, Quartz Fiber, 100 Pack	460139	
47 mm Filter Cassette Holder and Tray Door	80398	

Inlet Components





PM _{2.5} Sharp Cut Cyclone, 2 LPM	SCC 112	
PM ₁₀ Sharp Cut Cyclone, 2 LPM	SCC 110	
PM ₁ Sharp Cut Cyclone, 2 LPM	SCC 111	
TSP Sampling Inlet Harsh environment, with insect screen and rain cap	9441	
Cross-arm Clamp, 3/4" x 3/4", Aluminum Mounts cross-arms to the E-Sampler tripod	1552	
Cross-arm, 3/4", 18" long, Aluminum Tube	1539-18	

Meteorological Sensors

Wind Speed and Wind Direction Combination Sensor For use with E-BAM and E-SAMPLER. With 191-1 cross-arm kit and 9249 cable.	EX-034	
---	--------	---

Ambient Relative Humidity Sensor Kit with 9249 cable and 9427 cable junction box	EX-593	
---	---------------	---

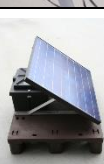
Miscellaneous Accessories

Lithium Battery, Memory Backup	9316	
E-Sampler Main Circuit Board Stack Assembly	80103	
LCD Display, E-Sampler, 4x20 Character (call Met One technical service)	701735	
Pole Mount Bracket for E-Sampler. Mounts the unit enclosure to a mast, post, wall, or other vertical surface.	9425	
Battery, 12V, 12aH, Lead Acid, Yuasa NP-12-12	390048	
Internal Battery Harness, Fused	9423	
Fuse, For Internal Battery Harness, 5 Amp	590807	
Power Supply, E-Sampler, 100 - 240V AC input 15V DC output, Weatherproof.	9438-2	
Solar Power Kit, 160W, 3.7 minimum PSH	730139	
Solar Power Kit, 240W, 2.5 minimum PSH	730140	
Tripod Assembly, E-BAM/E-SAMPLER	EX-905	
Phone Line Modem Kit, Weatherproof	EX-996	
Cellular Modem Kit (Call Met One for Details)	call	
Power Cable, E-Sampler to Battery	9638	
Power Cable, E-Sampler to Battery with alarm relay output wires	9638-1	
Serial Cable, E-Sampler	9321	
Serial Cable, E-sampler with analog output wires	9321-1	
E-Sampler Factory Service and Recalibration	SVC4105	Call Met One