

# MANUAL

---



## Electrostatic Field Meter EFM 235 / 255

---

System Prof. Dr.-Ing. Hans Kleinwächter

## Contents

General information about electrostatics .....	3
Origin of electrostatic charge .....	3
Product description.....	3
Measuring principle .....	3
Application Areas .....	3
Specifications .....	4
Legend .....	4
Start Condition .....	4
Manual .....	5
Startup Menu.....	5
Main Menu.....	5
Sub Menu => MODE.....	6
Sub Menu => ZERO .....	6
Sub Menu => START.....	7
Sub Menu => OFF .....	8
Measure Range.....	9
Tripod Connection.....	9
Battery Supervision.....	9
Grounding.....	10
Electric Field Strength.....	10
Voltage Metering with MK1 / HMK40 .....	10
Scope of Delivery.....	11
Maintenance .....	11
NiMH Storage Battery .....	12
Warranty.....	12
Warning Notices .....	12
Calibration.....	12

## General information about electrostatics

Nowadays ESD<sup>1</sup> is a problem at many workstations, because modern microelectronics<sup>2</sup> are easily destroyed by the sequels of ESD. Other branches of industry like e.g. telecommunications-, plastics-, and explosive material industry are also heavily affected by ESD.

ESD causes losses of time as well as high financial losses and can endanger the human health. Charges of over 10000 Volts can have effects on people, clothes, materials, and equipment. Devices that are sensitive to electrostatics can be damaged by electrostatic discharges of less than 100 Volts.

Charges of 3000 Volts and more can cause sparks. In endangered areas that can cause explosions.

## Origin of electrostatic charge

Triboelectricity<sup>3</sup> is caused by attrition of different materials. Electrons are transferred from one material to the other. As electrons are charged negative the material that releases electrons is charged positive. The material emitting electrons is charged negative. There are different ways to avoid or to discharge electrostatic charges. But to find an effective and reasonable solution first the emitted amount and polarity of the charge must be found. Our devices are suitable for that purpose and for the supervision of desired charge.

## Product description

The unit is housed into an EMV aluminum enclosure. The influence electrode is star shaped. In front of it in a small distance apart a rotating grounded modulation propeller with the same shape as the electrode is located. The influence electrode is enclosed by a ring electrode system that is used as a mechanical shield for the propeller wheel and the sensor plate. Measurement values are displayed on a graphic LC display.

The device has an integrated micro processor with USB 2.0 Interface.

## Measuring principle

The electrostatic field meter is a parametric amplifier. The electric field influences a current proportional to the electrostatic field. The current is amplified and measured with a selective amplifier. No energy is taken from the field over time means.

***No radioactive matters are used!***

---

## Application Areas

*Detection and Control* of electrostatic fields resp. charges, *measuring* of electric charges, electrostatic charges, very high-resistance voltage sources, very low currents, or high resistances.

---

<sup>1</sup> electrostatic discharge

<sup>2</sup> integrated circuits

<sup>3</sup> Greek: tribeia = friction

## Specifications

<b>Dimension (L x W x H):</b>	170mm x 77mm x 73,5mm
<b>Weight:</b>	550gr
<b>Calibration in a plate capacitor:</b>	400mm x 400mm, Distance 100mm
<b>Calibration accuracy:</b>	< 2%
<b>Interface:</b>	Mini USB 2.0 Buchse
<b>Power supply:</b>	Power supply 230V 50Hz sek. 9V 300mA
<b>Battery:</b>	4 xNiMH rechargeable Battery AA
<b>Operating time:</b>	Min. 4h

## Legend

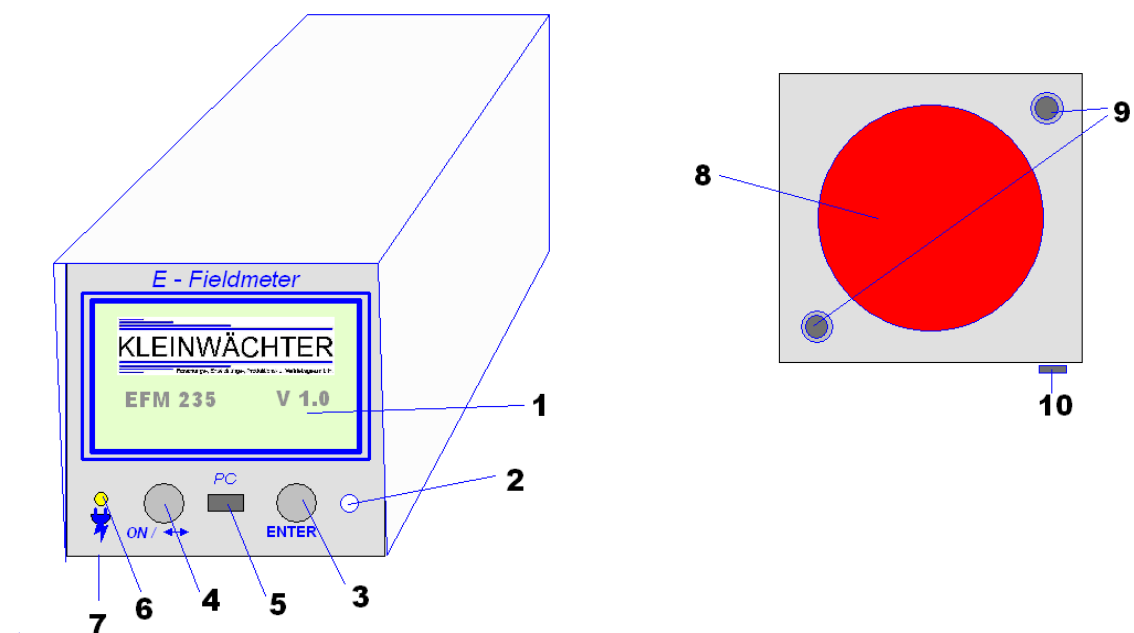

- |   |                      |    |  |
|---|----------------------|----|--|
| 1 | Graphic LC-Display   | 6  | Charge Control-LED                           |
| 2 | Zero - Potentiometer | 7  | Power Interface                              |
| 3 | „ENTER“ Button       | 8  | Modulator System with cover (protective cap) |
| 4 | „On“ „↔“ Button      | 9  | Connection for MK1                           |
| 5 | Mini USB Interface   | 10 | Grounding Jack                               |

## Start Condition

**The protective cap on the modulator system in front must be removed before measuring!**

## Manual

By pressing the «ON» Button (4) on the back of the unit it switches on.

In the display it appears for 3 sec. :

## Startup Menu

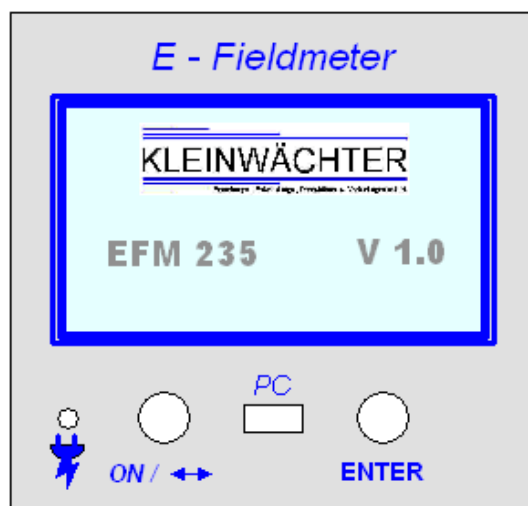

It shows the Type = EFM 235/EFM 255 and the Version Number V X.X

After that, the unit switches to:

## Main Menu

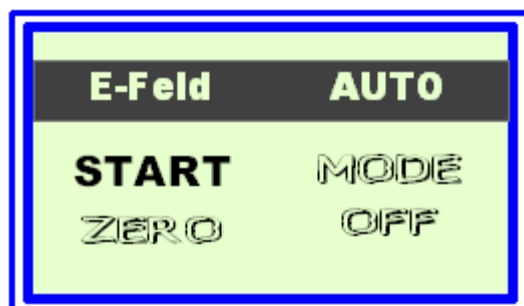

In the dark field it shows the selected Mode.

Press the „ $\leftrightarrow$ “ Button (4) to select the Sub Menu.

Selected Menu is black => ( **START** )

Press the „**ENTER**“ button (3) to go to the selected Sub Menu.

## Sub Menu =&gt; MODE



First the upper line is black. By pressing the „ $\leftrightarrow$ “ Button(4) you can change the Mode. Selection => **E-Feld** => **V-Meter MK1** => **HV-Met.MK40** => E-Feld => etc.

Press the „**ENTER**“ button (3) to choose the selected Mode and the 2nd line becomes black. By pressing the „ $\leftrightarrow$ “ Button(4) you can switch between **AUTO** and **MANUAL** .

Press the „**ENTER**“ button (3) to choose the selection and the 3<sup>rd</sup> line becomes black.

Press the „**ENTER**“ button (3) again to go back to the Main Menu.

By pressing the „ $\leftrightarrow$ “ Button(4) you come back to the 1st. line and you can start a new selection.

## Sub Menu =&gt; ZERO



In the dark field it shows an advice to set the cover (protection cap) onto the modulator system. Press the „ $\leftrightarrow$ “ Button (4) to select **START** or **BACK**.

Press the „**ENTER**“ button (3) by Start the Zero adjustment starts, by Back you switch back to the Main Menu.



The buttons are out of function during the Zero procedure.  
Do not remove the cover during this procedure! Displayed Range 0-3 is in process.

After successful Zero adjustment it displays

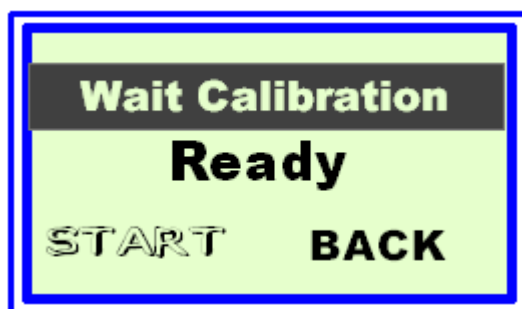

Press the „ENTER“ button (3) to go back to the Main Menu.

By pressing the „ $\leftarrow\rightarrow$ “ Button(4) and select Start then pressing „ENTER“ button (3) you can restart the Zero adjustment.

If no Zero adjustment is possible it appears in the display:

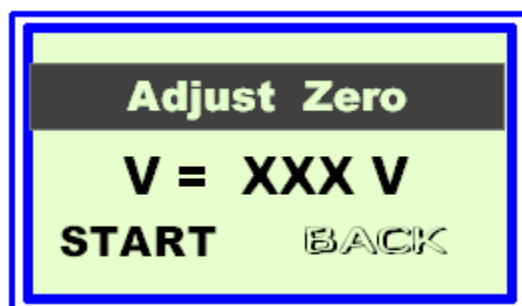

In this case adjust by the Zero Potentiometer on the back the Voltage to  $V < 0,10V$

After that, press the „ENTER“ button (3) to Start the calibration again.

**Sub Menu => START**

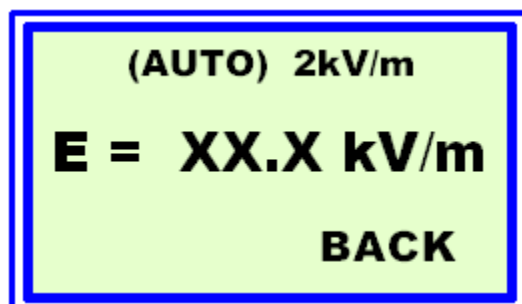

In the 1st. line it shows the selected Measure Mode => **AUTO** and the actual Range => **2kV/m**.  
In the 2nd line it shows by E-Feld Measurement  $\rightarrow E = (\text{actual value}) \text{ kV/m}$

Press the „ENTER“ button (3) to go back to the Main Menu.

In case the "MANUAL" Mode is chosen it appears in the display:

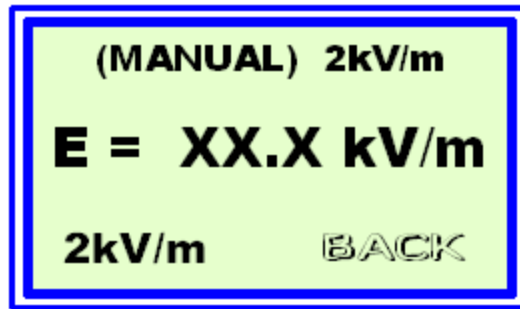

In the 1st. line it shows the selected Measure Mode => **MANUAL** and the Selected Range => **2kV/m**.

In the 2nd line it shows by E-Feld Measurement → **E = (actual value) kV/m**

By pressing the „↔“ Button(4) you can change the Measure Range.

Press the „ENTER“ button (3) to select **BACK** and again to go back to the Main Menu.

By selected Measure Mode => Voltmeter MK1 or HMK40 it appears in the display:

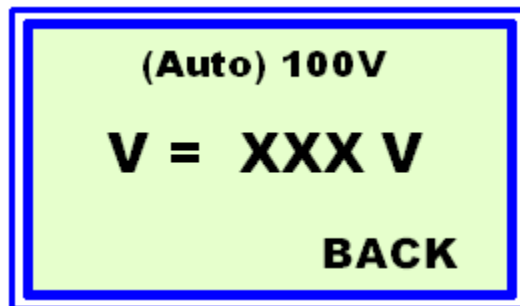

The service is like the E-Field Mode.

Only in the 2nd line it shows the voltage → **V = not E =** and **V not kV/m**.

### Sub Menu => OFF

Press the „↔“ Button (4) in Main Menu to select **OFF**

Then Press the „ENTER“ button (3) to switch off.



After a few seconds the instrument will switch off !



## Measure Range

By E-Field Measurement you can chose the following Ranges:

Range	EFM255	EFM235	Gain Factor
3	200V/m	2kV/m	x 100
2	1kV/m	10kV/m	x 20
1	4kV/m	40kV/m	x 5
0	20kV/m	200kV/m	x 1

By Voltage Measurement with the HV – Measuring Heads you get following ranges:

Range	MK1 255	MK1 235	MK40 235*
3	2 V	20 V	400 V
2	10 V	100 V	2 kV
1	40 V	400 V	8 kV
0	200 V	2 kV	40 kV

\* The Measuring Head HMK 40 is only applicable with the EFM 235..

**In Mode „AUTO“ the ranges switches automatically !**

## Tripod Connection



To use the Instrument on a table (with MK1) you can change the handle to a tripod.

To release the hand grip, loosen the attaching finger screw (wheel).

Then screw the tripod into the recessed thread.



Please notice, that the screw thread in the recessed thread is a M6 thread and the thread on the tripod is an imperial thread.

Screw it until finger tight.

## Battery Supervision

The device has an integrated battery supervision function.

If the battery voltage decreases below 4.8V, in the display appears “Low Battery”.

By decreases below 4.5V it appears in the display “Switch OFF”

To prevent total discharge of the battery the device is automatically powered off. In this case the battery has to be loaded on the power interface (7) with the shipped charger for about 12-14h.

## Grounding

The device must be grounded properly to measure the amount and the polarity of an electrostatic field.

For that purpose, the device must be connected to ground by using the grounding jack (10) on the bottom.

Grounding the device by a grounded person (e.g. over conductive shoes or wrist strap) touching the handle suffices under most circumstances.

## Electric Field Strength

For measuring the electric field strength at first the protective cap must be removed. Afterwards the electrostatic field meter must be adjusted with the modulator system parallel to the object to be measured.

The distance between the EFM 120 and the object to be measured must be kept constant, as the distance is for the voltage calculation. The measured field strength is displayed in kV/m.

The charge in Volt is obtained by multiplying the displayed value with the distance in meters.

**For example:** The distance between the object and the device is  $d=5\text{cm}$  and the measured field strength  $E=1,6\text{kV/m}$ , the surface potential  $U$  is calculated as follows:

Surface charge = field strength x distance  $d$  (m)

$$U = E \times d \text{ (in m)} \Rightarrow U = 1600\text{V/m} \times 0,05\text{m} = 80 \text{ V}$$

Please pay attention to use correct units. To avoid these problems, we recommend using SI units.

## Voltage Metering with MK1 / HMK40

With the optional voltage gauge head MK1/HMK40 voltages up to  $\pm 2\text{kV}/40\text{kV}$  can be measured with an internal resistance  $R_i > 10^{16}\Omega$ . For high voltage measurements the guidelines of the European standard EN 10100 need to be considered.

The voltage gauge head must be mounted on the modulator system of the static meter for measurements

The generated linear voltmeters have the following outstanding properties:

<b>Input capacitance:</b>	approx. 5pF
<b>Input resistance:</b>	$>10^{16}\Omega$ with appropriate gauge head

## Scope of Delivery



The basic equipment of the electrostatic field meter includes the following components:

- Carrying case with ESD foam
- Electro static field meter EFM 235/255
- Measuring diaphragm
- Power supply
- USB cable with mini plug
- tripod
- Grounding spiral cable
- CD with EFM\_ReadOut Software
- Manual
- Declaration of factory calibration

### Optional available:

- Voltage gauge head MK1
- High Voltage gauge head HMK40
- Thread measuring head

By using our BGT 200 Set including MK1, Hand Electrode and 3m PTFE cable you can make a walking test conform to the standard DIN EN 61340-4-5.

## Maintenance

The modulator system or parts of it must not be touched.

Those parts must be protected from dust, isolating impurity layers, color- or paint haze and condensate.

If required, the modulator system can be cleaned with ethyl alcohol and a lint-free cotton cloth.

## NiMH Storage Battery

Even if the device is not used for longer terms, the battery must be charged after 6 months to prevent total discharge.

If the battery cannot be charged anymore, the battery must be changed. For that purpose, the device must be sent to the manufacturer.

## Warranty

We provide a 24-month warranty in case of proper application according to the manual.

Excluded of the guarantee are:

The rechargeable battery, damage by electric shock, wrong grounding, and mechanical damage of the device. The guarantee expires if the device was opened.

## Warning Notices

- The electrostatic field meter must not be opened. By opening the guarantee expires.
- The electrostatic field meter must not be used in explosive areas. No admission for explosive areas.
- If high charges are possible the electrostatic field meter must be grounded. An adequate distance must be kept.
- Flashovers on the modulator system must be avoided!
- The use of the device in power plants or comparable areas is prohibited!
- The device cannot measure alternating fields > 1Hz!

## Calibration

A check of the measurement values is recommended annually.

