

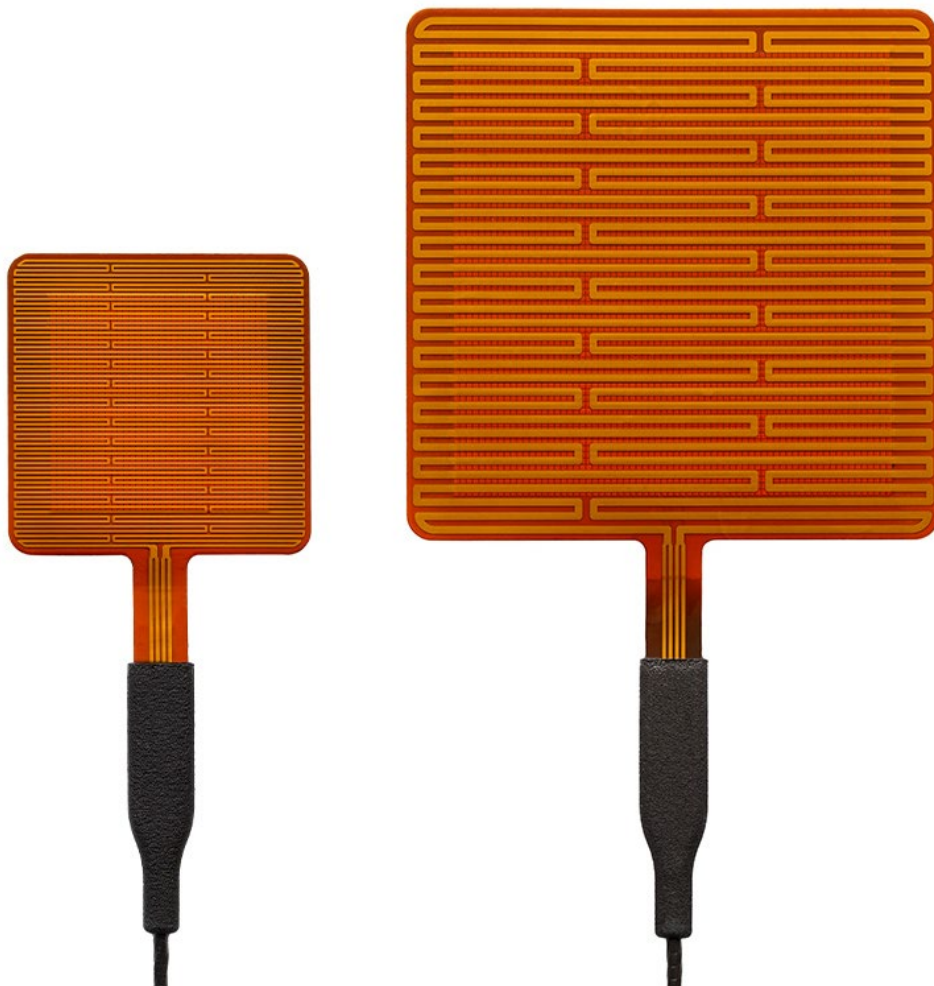

USER MANUAL

FHF05SC series

Self-calibrating foil heat flux sensor with thermal spreaders and heater



Cautionary statements

Cautionary statements are subdivided into four categories: danger, warning, caution and notice according to the severity of the risk.

 DANGER
Failure to comply with a danger statement will lead to death or serious physical injuries.

 WARNING
Failure to comply with a warning statement may lead to risk of death or serious physical injuries.

 CAUTION
Failure to comply with a caution statement may lead to risk of minor or moderate physical injuries.

NOTICE
Failure to comply with a notice may lead to damage to equipment or may compromise reliable operation of the instrument.

Contents

Cautionary statements	2
Contents	3
List of symbols	4
Introduction	5
1 Ordering and checking at delivery	9
1.1 Ordering FHF05SC series	9
1.2 Included items	9
1.3 Quick instrument check	10
2 Instrument principle and theory	11
2.1 Theory of operation	11
2.2 The self-test	14
2.3 Calibration	14
2.4 Application example: stable performance check	15
2.5 Application example: non-invasive core temperature measurement	18
3 Specifications of FHF05SC series	19
3.1 Specifications of FHF05SC series	19
3.2 Dimensions of FHF05SC series	22
4 Standards and recommended practices for use	23
4.1 Heat flux measurement in industry	23
5 Installation of FHF05SC series	24
5.1 Site selection and installation	24
5.2 Installation on curved surfaces	26
5.3 Electrical connection	27
5.4 Requirements for data acquisition / amplification	30
6 Maintenance and trouble shooting	31
6.1 Recommended maintenance and quality assurance	31
6.2 Trouble shooting	32
6.3 Calibration and checks in the field	34
7 Appendices	35
7.1 Appendix on cable extension	35
7.2 Appendix on using FHF05SC series with BLK – GLD sticker series	36
7.3 Appendix on standards for calibration	37
7.4 Appendix on calibration hierarchy	37
7.5 Appendix on correction for temperature dependence	38
7.6 Appendix on measurement range for different temperatures	39
7.7 Appendix on temperature measurement accuracy	40
7.8 EU declaration of conformity	42

List of symbols

Quantities

Heat flux
 Voltage output
 Sensitivity
 Temperature
 Thermal resistance per unit area
 Area
 Electrical resistance
 Electrical power

Symbol

Unit

Φ W/m²
 U V
 S V/(W/m²)
 T °C
 R_{thermal,A} K/(W/m²)
 A m²
 R Ω
 P W

subscripts

property of heatsink
 property of heater
 property of sensor
 maximum value, specification limit

heatsink
 heater
 sensor
 maximum

Introduction

FHF05SC series is a combination of the standard model FHF05 heat flux sensor and a heater. The heater allows the user to perform self-tests, verifying sensor functionality and stability during use, without having to remove the sensor. FHF05SC series are ideal for high-accuracy and long-term heat flux measurement, construction of calorimeters, (zero heat flux) core temperature measurement and thermal conductivity test equipment. Available in two models: size 50X50 mm and a larger size of 85X85 mm.

FHF05SC series measures heat flux through the object in which it is incorporated or on which it is mounted, in W/m^2 . The sensor within is a thermopile. This thermopile measures the temperature difference across FHF05SC's flexible body. A type T thermocouple is integrated as well to provide a temperature measurement. The thermopile and thermocouple are passive sensors; they do not require power.

Multiple small thermal spreaders, which form a conductive layer covering the sensor, help reduce the thermal conductivity dependence of the measurement. With its incorporated spreaders, the sensitivity of FHF05SC series is independent of its environment. Many competing sensors do not have thermal spreaders. The passive guard area around the sensor reduces edge effects and is also used for mounting. Looking for only heat flux and temperature measurement without a heater? See our [FHF05 series](#) heat flux sensors.

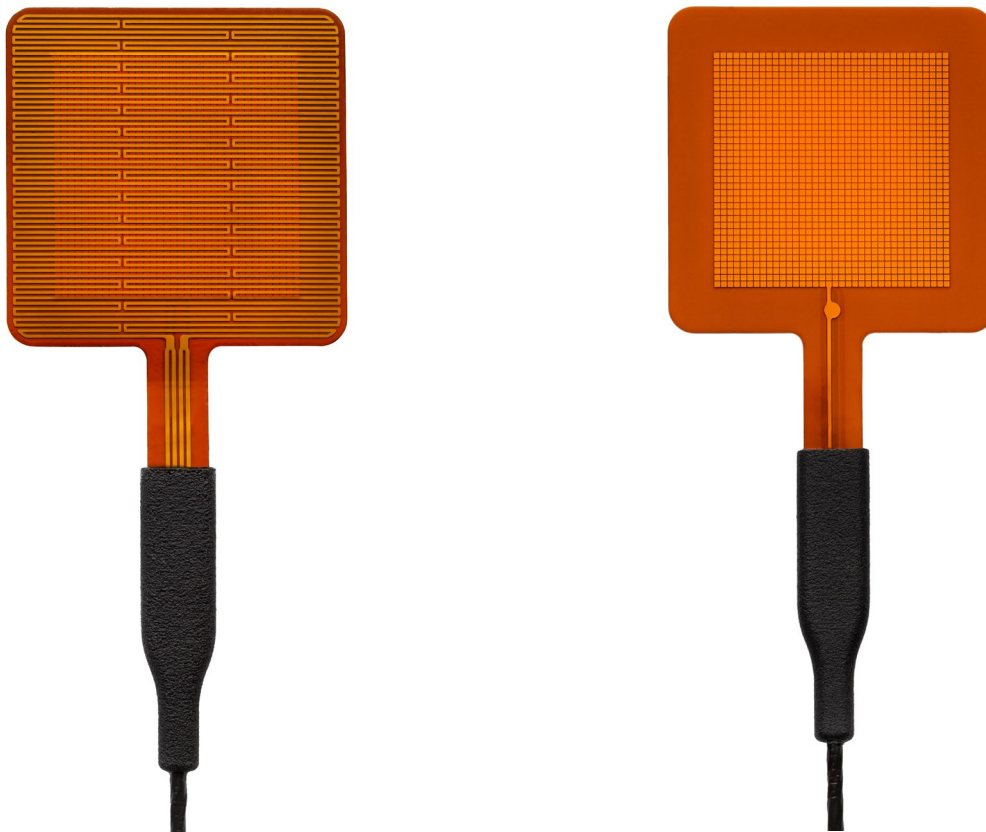

Figure 0.1 Model FHF05SC-50X50 self-calibrating foil heat flux sensor with thermal spreaders and heater, showing its back and front side.

Measuring heat flux, users may wish to regularly check their sensor performance. During use, the film heater is activated to perform a self-test. The heat flux sensor response to the self-test results in a verification of sensor performance. Implicitly also wire connection, data acquisition, thermal connection of the sensor to its environment and data processing are tested. Heat flux sensors are often kept installed for as long as possible. Using self-testing, the user no longer needs to take sensors to the laboratory to verify their stable performance. In a laboratory environment, using a metal heat sink, you may even perform a formal calibration. The heater has a well characterised and traceable surface area and electrical resistance.

The FHF05SC series self-calibrating foil heat flux sensor has unique features and benefits:

- heater for self-test
- flexible (bending radius $\geq 15 \times 10^{-3}$ m)
- low thermal resistance
- wide temperature range
- fast response time
- integrated type T thermocouple
- robustness, including cable and connection block which may be used as strain relief
- IP protection class: IP67 (essential for outdoor application)
- integrated thermal spreaders for low thermal conductivity dependence

FHF05SC series suggested use:

- high-accuracy scientific measurement of heat flux, with a high level of data quality assurance
- study of convective heat transfer mechanisms
- calorimeter prototyping
- (zero heat flux) non-invasive core temperature measurement
- thermal conductivity test equipment



Figure 0.2 Application example: FHF05SC-50X50 being installed to measure heat flux on a pipe. The sensor is mounted on a well-prepared curved surface.

Using FHF05SC series is easy. It can be connected directly to commonly used data logging systems. The heat flux in W/m^2 is calculated by dividing the sensor output, a small voltage, by the sensitivity. The sensitivity is provided with FHF05SC series on its product certificate.

Equipped with a protective potted connection block, which may serve as strain relief so that moisture does not penetrate, FHF05SC series has proven to be very robust and stable.

FHF05SC series calibration is traceable to international standards. The factory calibration method follows the recommended practice of ASTM C1130 - 21. When used under conditions that differ from the calibration reference conditions, the FHF05SC series sensitivity to heat flux may be different than stated on its certificate. See Chapter 2 in this manual for suggested solutions.

Would you like to study energy transport / heat flux in detail? Hukseflux helps taking this measurement to the next level: order FHF05SC series with radiation-absorbing black and radiation-reflecting gold stickers. You can then measure convective + radiative flux with one, and convective flux only with the other. Subtract the 2 measurements and you have radiative flux. They can be applied to the sensor by the user or at the factory; see the BLK - GLD sticker series user manual and [installation video](#) for instructions.

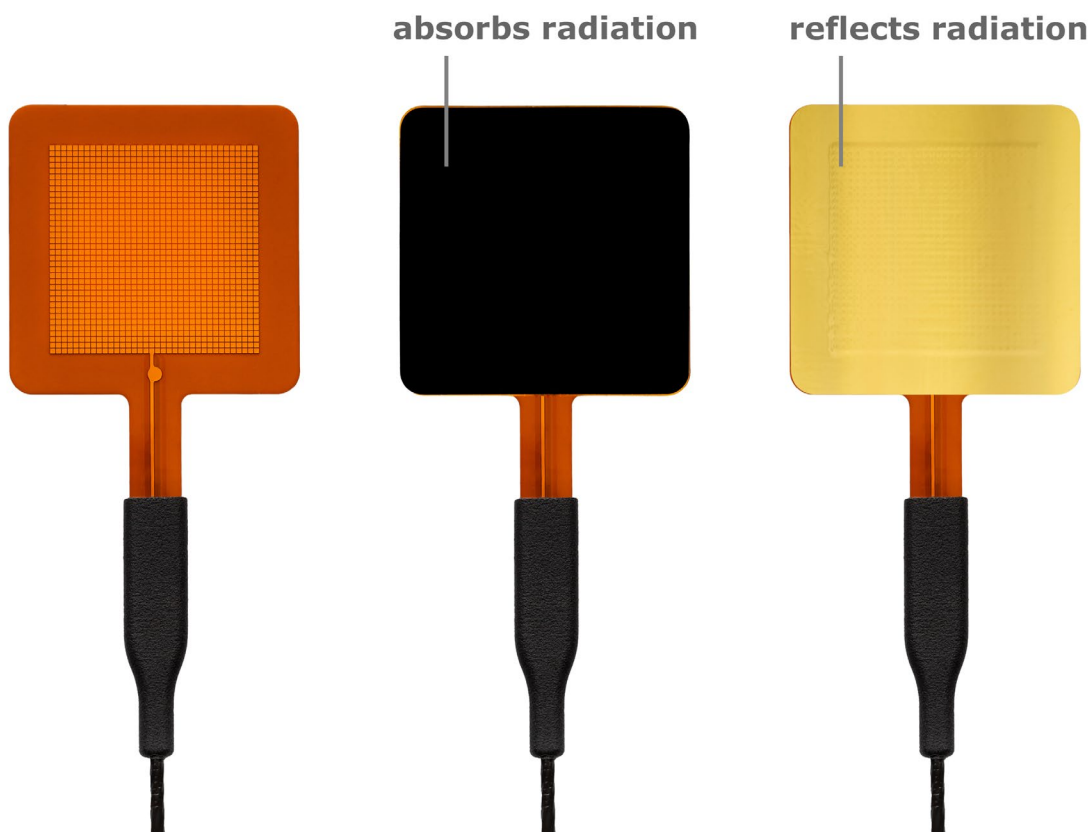

Figure 0.3 FHF05SC-50X50 heat flux sensor: with BLK-5050 and GLD-5050 stickers.

See also:

- **FHF05 series**, our standard model for general-purpose heat flux measurement
- model **HFP01** for increased sensitivity (also consider putting two or more FHF05s in series)
- **HTR02 series heater**, for calibration and verification of performance of FHF-type sensors.
- **BLK - GLD sticker series** to separate radiative and convective heat fluxes
- Hukseflux offers a complete range of **heat flux sensors** with the highest quality for any budget

1 Ordering and checking at delivery

1.1 Ordering FHF05SC series

The standard configuration of FHF05SC series is FHF05SC-50X50-02, model 50X50 with 2 metres of cable. Common options are:

- model FHF05SC-85X85
- change -02 to -05 or -10 metres cable length
- with a separate cable in 2, 5 or 10 metres cable length
- with LI19 hand-held read-out unit / datalogger; NOTE: LI19 does not measure temperature, only heat flux and does not support self-test functionality
- BLK black sticker (to measure radiative as well as convective heat flux)
- GLD gold sticker (to measure convective heat flux only)
- BLK - GLD sticker series can also be ordered pre-applied at the factory for every sensor dimension

1.2 Included items

Arriving at the customer, the delivery should include:

- heat flux sensor FHF05SC with cable of the length as ordered
- product certificate matching the instrument serial number

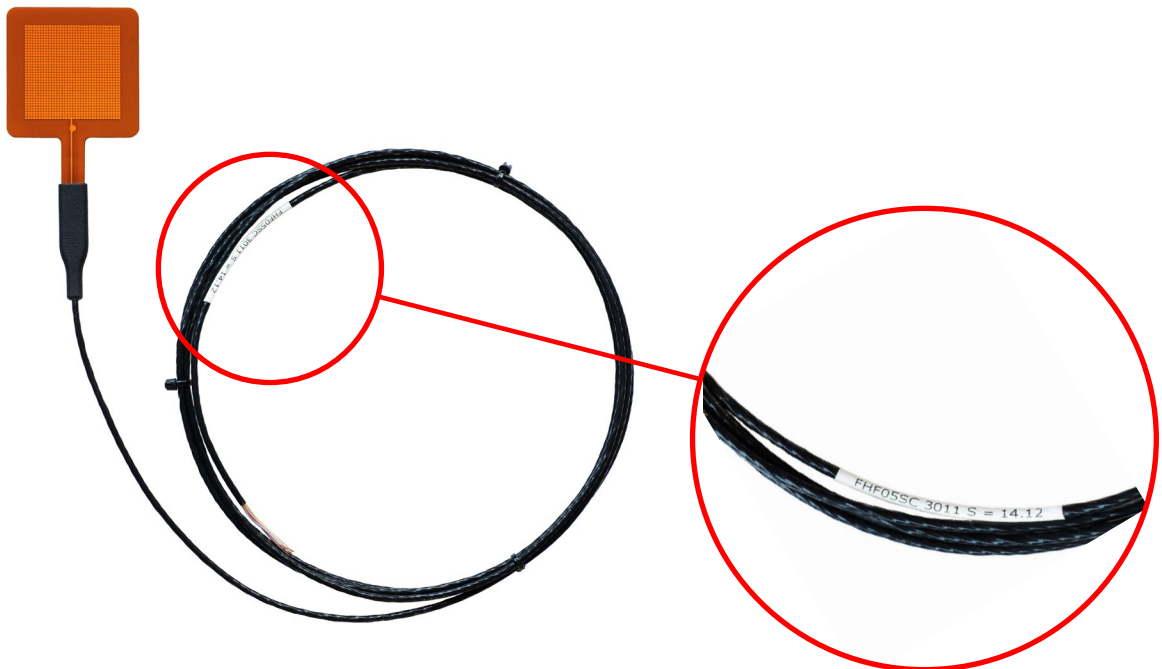

Figure 1.2.1 Model FHF05SC-50X50 with serial number and sensitivity shown at the end of the cable.

1.3 Quick instrument check

A quick test of the instrument can be done by connecting it to a multimeter.

1. Check the sensor serial number and sensitivity on the sticker on the potted connection block against the product certificate provided with the sensor.
2. Inspect the instrument for any damage.
3. Check the electrical resistance of the sensor between the red [+] and black [-] wires. Use a multimeter at the 1k Ω range. Measure the sensor resistance first with one polarity, then reverse the polarity. Take the average value. The typical resistance of the wiring is 0.3 Ω /m. Typical resistance should be the nominal sensor resistance mentioned in table 3.1.1 plus 0.6 Ω for the total resistance of two wires for each metre (back and forth). Infinite resistance indicates a broken circuit; zero or a lower than 1 Ω resistance indicates a short circuit.
4. Check the electrical resistance of the thermocouple between the brown [+] and white [-] wires. Use a multimeter at the 100 Ω range. Measure the thermocouple resistance first with one polarity, then reverse the polarity. Take the average value. The typical resistance of the copper wiring is 0.3 Ω /m, for the constantan wiring this is 6.5 Ω /m. Typical resistance should be the nominal thermocouple resistance of 2.5 Ω plus 6.8 Ω for the total resistance of the two wires of each metre (back and forth). Infinite resistance indicates a broken circuit; zero or a lower than 1 Ω resistance indicates a short circuit.
5. Check if the sensor reacts to heat: put the multimeter at its most sensitive range of DC voltage measurement, typically the 100×10^{-3} VDC range or lower. Expose the sensor to heat. Exposing the back side (the side with the heater) to heat should generate a positive signal between the red [+] and black [-] wires. Doing the same at the front side (the side with the dot), reverses the sign of the output.
6. Check the electrical resistance of the heater between purple or yellow wire and pink or green wire. Use a multimeter at the 1 k Ω range. Typical resistance should be around 120 Ω for model -50X50 and around 40 Ω for model -85X85 . Infinite resistance indicates a broken circuit; zero or a lower than 1 Ω resistance indicates a short circuit.
7. Check the electrical resistance between the purple and yellow wires. . These resistances should be in the 0.1 Ω /m range, so 0.2 Ω in case of the standard 2 m wire length. Higher resistances indicate a broken circuit. Repeat this measurement for the pink and green wire.

2 Instrument principle and theory

FHF05SC series' scientific name is heat flux sensor. A heat flux sensor measures the heat flux density through the sensor itself. This quantity, expressed in W/m^2 , is usually called "heat flux".

FHF05SC series users typically assume that the measured heat flux is representative of the undisturbed heat flux at the location of the sensor. Users may also apply corrections based on scientific judgement. FHF05SC series has an integrated film heater. At a regular interval the film heater can be activated to perform a self-test. The self-test results in a verification of sensor performance. See the next chapters for examples how the self-test may be used. Implicitly also wire connection, data acquisition and data processing are tested.

2.1 Theory of operation

The sensor in FHF05SC series is a thermopile. This thermopile measures the temperature difference across the polyimide body of the sensor. Working completely passive, the thermopile generates a small voltage that is a linear function of this temperature difference. The heat flux is proportional to the same temperature difference divided by the effective thermal conductivity of the heat flux sensor body.

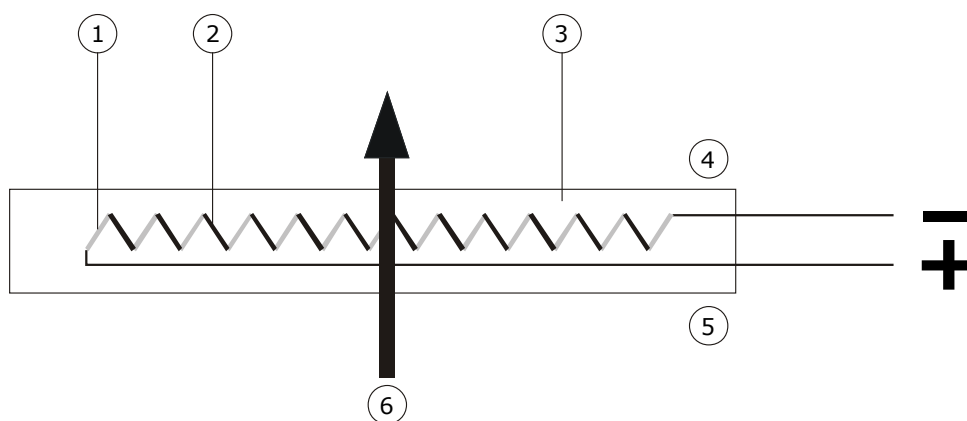

Figure 2.1.1 The general working principle of a heat flux sensor. The sensor inside FHF05SC series is a thermopile. A thermopile consists of a number of thermocouples, each consisting of two metal alloys (marked 1 and 2), electrically connected in series. A single thermocouple generates an output voltage that is proportional to the temperature difference between its hot- and cold joints. Putting thermocouples in series amplifies the signal. In a heat flux sensor, the hot- and cold joints are located at the opposite sensor surfaces (4 and 5). In steady state, the heat flux (6) is a linear function of the temperature difference across the sensor and the average thermal conductivity of the sensor body (3). The thermopile generates a voltage output proportional to the heat flux through the sensor. The exact sensitivity of the sensor is determined at the manufacturer by calibration and can be found on the product certificate that is supplied with each sensor.

Using FHF05SC series is easy. For readout the user only needs an accurate voltmeter that works in the millivolt range. To convert the measured voltage, U , to a heat flux Φ , the voltage must be divided by the sensitivity S , a constant that is supplied with each individual sensor.

$$\Phi = U/S \quad \text{(Formula 2.1.1)}$$

FHF05SC series is designed in such a way that heat flux from the back side to the front side generates a positive voltage output signal. The dot on the foil indicates the front side.

Unique features of FHF05SC series include flexibility (bending radius $\geq 15 \times 10^{-3}$ m), high sensitivity, low thermal resistance, a wide temperature range, a fast response time, IP67 protection class rating (essential for outdoor application), and the inclusion of thermal spreaders to reduce thermal conductivity dependence.

FHF05SC' are calibrated under the following reference conditions:

- conductive heat flux (as opposed to radiative or convective heat flux)
- homogeneous heat flux across the sensor and guard surface
- room temperature
- heat flux in the order of 300 to 600 W/m²
- mounted on aluminium heat sink

FHF05SC series has been calibrated using a well-conducting metal heat sink, representing a typical industrial application, at 20 °C and exposing it to a conductive heat flux. When used under conditions that differ from the calibration reference conditions, for example at extremely high or low temperatures, or exposed to radiative flux, the FHF05SC series sensitivity to heat flux may be different than stated on the certificate. In such cases, the user may choose:

- not to use the sensitivity and only perform relative measurements / monitor changes
- reproduce the calibration conditions by mounting the sensor on or between metal foils
- design a dedicated calibration experiment, using the integrated heater
- apply our BLK black sticker to the sensor surface to absorb radiation
- apply our GLD black sticker to the sensor surface to reflect radiation

The user should analyse his own experiment and make his own uncertainty evaluation. The FHF05SC series rated operating temperature range for continuous use is -70 to +120 °C, for short intervals a peak temperature of +150 °C is allowed. Prolonged exposure to temperatures near +150 °C can accelerate the aging process.



Figure 2.1.2 Heat flux from the back side to the front side generates a positive voltage output signal. The dot on the foil indicates the front side. The backside of the FHF05SC has a heater.

2.2 The self-test

A self-test is started by switching on FHF05SC's heater, while recording the sensor output signal and the heater power and is finalised by switching the heater off. During the heating interval a current is fed through the film heater, which generates a known heat flux. To calculate this heat flux, the heater power P_{heater} must be measured accurately. This power can be measured in several different ways;

- heater voltage and current, $P_{\text{heater}} = U_{\text{heater}} \cdot I_{\text{heater}}$ (Formula 2.2.1)
- heater voltage and known heater resistance, $P_{\text{heater}} = U_{\text{heater}}^2 / R_{\text{heater}}$ (Formula 2.2.2)
- heater current and known heater resistance, $P_{\text{heater}} = I_{\text{heater}}^2 \cdot R_{\text{heater}}$ (Formula 2.2.3)

The user must interrupt the normal measurement of the heat flux during the self-test.

Analysis of the heat flux sensor response to the heating, the self-test, serves several purposes:

- first, the amplitude and response time under comparable conditions are indicators of the sensor stability. See Section 2.4 and 2.5 for application examples.
- second, the functionality of the complete measuring system is verified. For example: a broken cable is immediately detected.
- third, under the right conditions, after taking the sensor out of its normal environment, the self-test may be used as calibration. See Section 2.3 for more details.

2.3 Calibration

FHF05SC series calibration is traceable to international standards. The factory calibration method follows the recommended practice of ASTM C1130 - 21. When used under conditions that differ from the calibration reference conditions, the FHF05SC series sensitivity to heat flux may be different than stated on its certificate.

In a typical calibration setup as shown in the next figure, the FHF05SC series is positioned between an insulating material and a heatsink with the FHF05SC series heater on the side of the insulating material. In such a setup, the heat losses through the insulation may be ignored. In this case all heat generated by the heater flows through the heat flux sensor to the heat sink. Measuring the heater power P_{heater} , and dividing by the surface area A_{heater} , gives the applied heat flux:

$$\Phi = P_{\text{heater}} / A_{\text{heater}} \quad (\text{Formula 2.3.1})$$

The heat flux sensor sensitivity S is the voltage output U_{sensor} divided by the applied heat flux Φ :

$$S = U_{\text{sensor}} / \Phi \quad (\text{Formula 2.3.2})$$

The reproducibility of this test is much improved when using contact material (such as glycerol or a thermal paste) between sensor and heat sink.

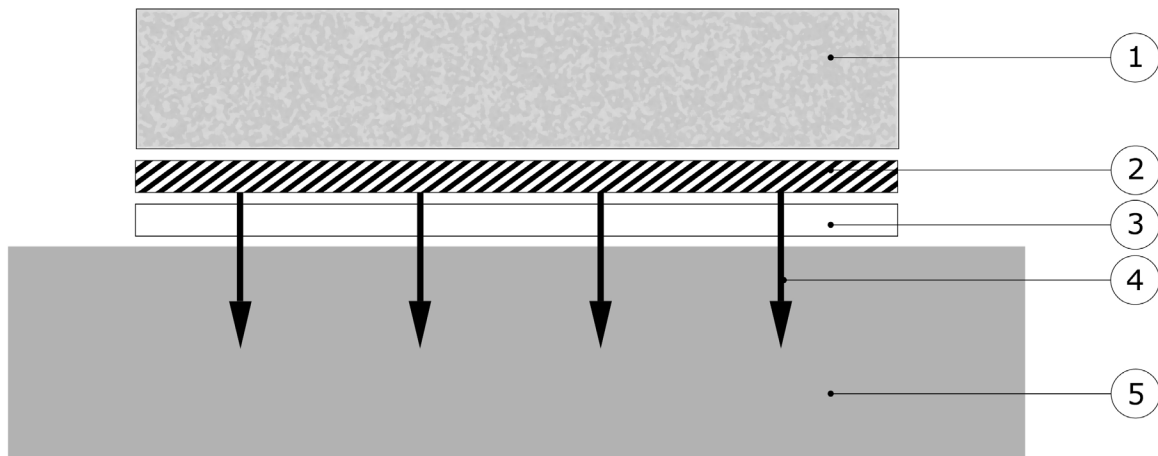

Figure 2.3.1 Calibration of FHF05SC series; a typical stack used for calibration consists of a block of metal (mass > 1 kg), for example aluminium (5), the heat flux sensor (3), with heater (2) and an insulation foam (1). Under these conditions, heat losses through the insulation are negligible. Heat flux (4) flows from hot to cold.

2.4 Application example: stable performance check

The FHF05SC series heater can be used to check for stable performance of the sensor at regular intervals without the need to uninstall the sensor from its application.

A typical stability check is performed based on the step response of the measured heat flux and sensor temperature to a heat flux applied by the heater. Upon installing the sensor, a reference measurement should be made. A time trace of the heater power, the measured heat flux and the measured sensor temperature should be stored as reference data. Stable operation of the sensor can then be confirmed at any time by comparing to the reference measurement. The test protocol consists of the following steps:

1. Make sure that the absolute temperature is similar to that during the reference measurement.
2. Check the heater resistance stability. This can be done accurately by using the four heater wires to conduct a four-point resistance measurement.
3. Record a time trace of the heater power, the measured heat flux and the sensor temperature; the same parameters as in the reference data. Normalise the data by the heater power. Under normal circumstances (if the heater is stable) this process scales with U_{heater}^2 .
4. Compare patterns of heat flux and temperature rise and fall. In both cases relative to the values just before heating.
 - When the signal patterns match, amplitude differences, after correction for heater power, point towards sensor instability. In this case recalibration of the sensor may be required (Figure 2.4.1).

- Non-matching patterns point towards changes in sensor environment. This can for example be the result of a loss of thermal contact between sensor and object (Figure 2.4.2) or the presence of convective heat losses (Figure 2.4.3).

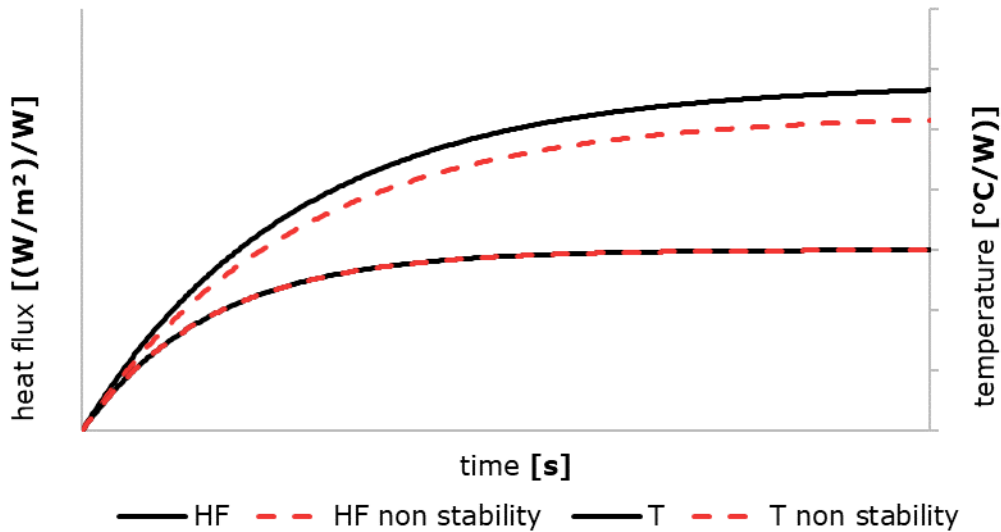

Figure 2.4.1 In-situ sensor stability check. Comparison of responses to stepwise heating relative to reference curves. Normalised to heater power (P) and relative to the heat flux and the temperature just before heating. Solid graphs show heat flux, dotted graphs show temperature. The black HF and T signals are the reference curves at installation. The sensor shows non-stability, loses sensitivity over time, which results in the red responses: equal response times, lower heat flux and equal temperature rise.

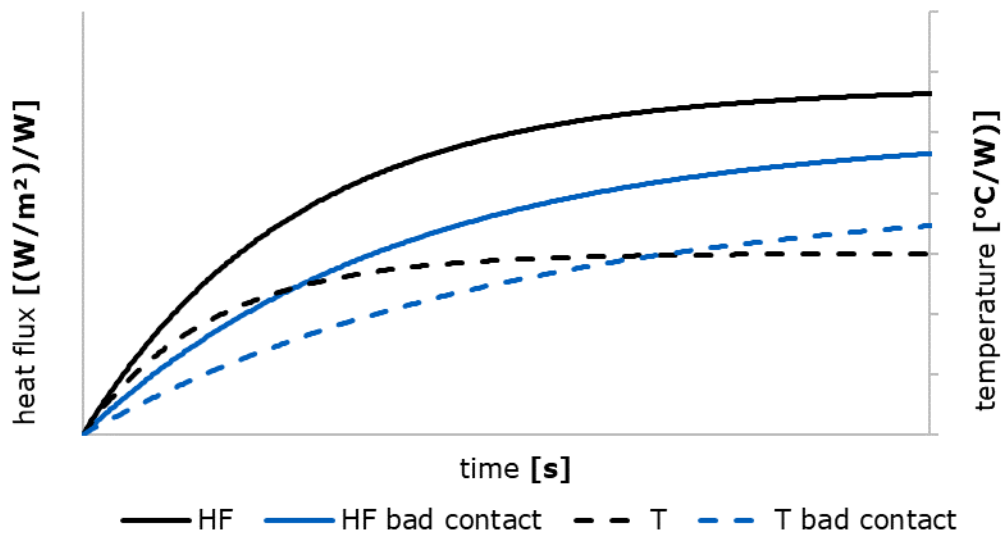

Figure 2.4.2 In situ sensor stability check. Comparison of responses to stepwise heating relative to reference curves. Normalised to heater power (P) and relative to the heat flux and the temperature just before heating. Solid graphs show heat flux, dotted graphs show temperature. The black HF and T signals are the reference curves at good thermal contact. The sensor loses thermal contact, which results in the blue responses: slower response times, lower heat flux and higher temperature rise.

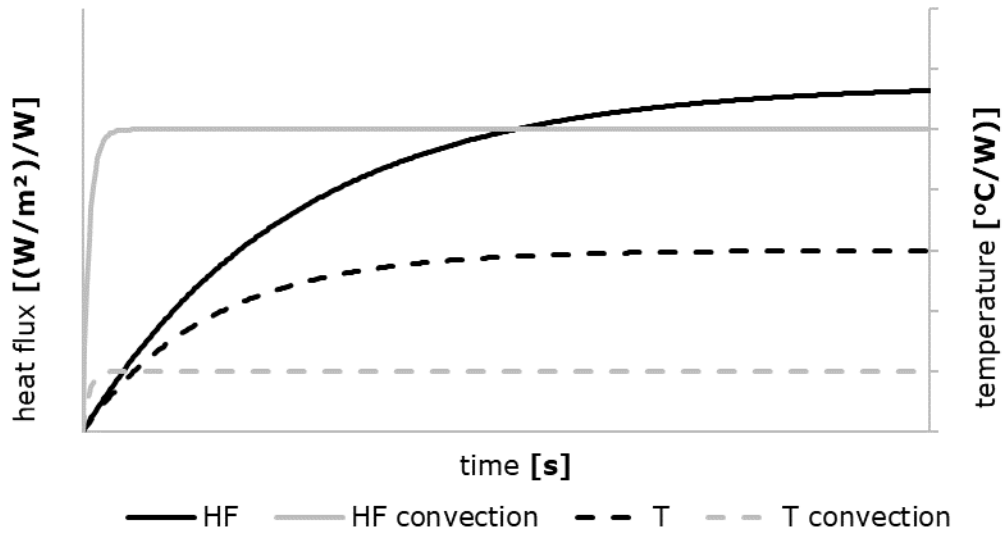

Figure 2.4.3 *In-situ sensor stability check. Comparison of responses to stepwise heating relative to reference curves. Normalised to heater power (P) and relative to the heat flux and the temperature just before heating. Solid graphs show heat flux, dotted graphs show temperature. The black HF and T signals are the reference curves at zero wind speed. The sensor is exposed to convection, which results in the grey responses: faster response times at lower heat flux and lower temperature rise.*

2.5 Application example: non-invasive core temperature measurement

FHF05SC series may be used for non-invasively measuring the core temperature of objects, for example of human beings.

The measurement is done by securely fixate the sensor on the object under test. The side of the heater should be surrounded with insulation material. All the heat is forced through the sensor. To determine the core temperature, the heater power should be adjusted such that the heat flux equals zero. When zero heat flux is attained, the temperature gradient equals zero and the measured temperature equals the core temperature.

To perform such a measurement a PID controller can be used to regulate the heating power. The setpoint of the PID controller should be set to zero heat flux. The PID controller can regulate the heater power either through a 0 – 12 V programmable power supply or via a solid-state relay controlled with a pulse-width-modulated signal.

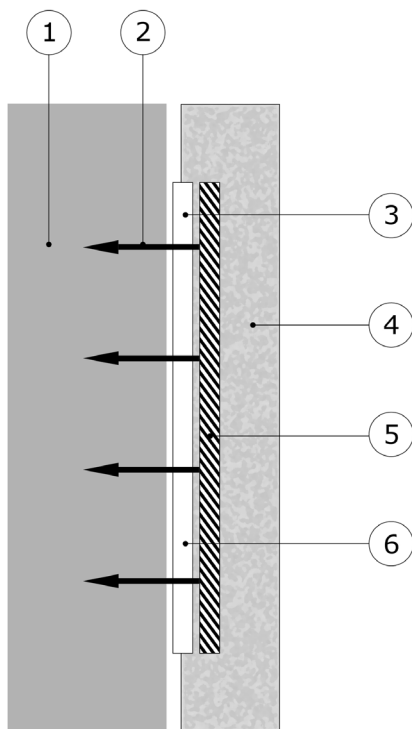

Figure 2.5.1 FHF05SC series in a non-invasive core-temperature measurement. For measurement of the core temperature (1), the heater (5) is controlled to a setpoint of zero heat flux (2) measured by the heat flux sensor (3). At zero heat flux, the temperature of the core (1) and the temperature sensor (6) are equal. Insulation material (4) is attached to work at stable boundary conditions.

3 Specifications of FHF05SC series

3.1 Specifications of FHF05SC series

FHF05SC series measures the heat flux density through the surface of the sensor. This quantity, expressed in W/m^2 , is called heat flux. Working completely passive, using a thermopile sensor, FHF05SC series generates a small output voltage proportional to this flux. It can only be used in combination with a suitable measurement system.

Table 3.1.1 Specifications of FHF05SC series (continued next pages).

FHF05SC SERIES SPECIFICATIONS	
Sensor type	self-calibrating foil heat flux sensor
Sensor type according to ASTM	heat flow sensor or heat flux transducer
Measurand	heat flux
Measurand in SI units	heat flux density in W/m^2
Measurement range	$(-10 \text{ to } +10) \times 10^3 \text{ W/m}^2$ at heat sink temperature $20 \text{ }^\circ\text{C}$ see appendix for detailed calculations
Sensitivity range (nominal)	
	FHF05SC-50X50 $13 \times 10^{-6} \text{ V}/(W/m^2)$
	FHF05SC-85X85 $50 \times 10^{-6} \text{ V}/(W/m^2)$
Directional sensitivity	heat flux from the back side (side with the heater) to the front side (side with the dot) generates a positive voltage output signal
Increased sensitivity	multiple sensors may be put electrically in series. The resulting sensitivity is the sum of the sensitivities of the individual sensors
Expected voltage output	$(-100 \text{ to } +100) \times 10^{-3} \text{ V}$ turning the sensor over from one side to the other will lead to a reversal of the sensor voltage output
Required readout	1 differential voltage channel or 1 single ended voltage channel, input resistance $> 10^6 \text{ } \Omega$
Optional readout	1 temperature channel
Rated load on cable	$\leq 1.6 \text{ kg}$
Rated bending radius	$\geq 15 \times 10^{-3} \text{ m}$
Rated operating temperature range, continuous use	$-70 \text{ to } +120 \text{ }^\circ\text{C}$
Rated operating temperature range, short interval	$-160 \text{ to } +150 \text{ }^\circ\text{C}$ (contact Hukseflux when measuring at $-160 \text{ }^\circ\text{C}$)
Temperature dependence	$< 0.2 \text{ } \%/^\circ\text{C}$
Non-linearity	$< 5 \text{ } \%$ ($0 \text{ to } 10 \times 10^3 \text{ W/m}^2$)
Solar absorption coefficient	0.75 (indication only)
Thermal conductivity dependence	Negligible, $< 3 \text{ } \%/(\text{W}/(\text{m}\cdot\text{K}))$ from $270 \text{ to } 0.3 \text{ W}/(\text{m}\cdot\text{K})$
Sensor length and width	
	FHF05SC-50X50 $(50 \times 50) \times 10^{-3} \text{ m}$
	FHF05SC-85X85 $(85 \times 85) \times 10^{-3} \text{ m}$
Sensor sensing area	
	FHF05SC-50X50 $12.96 \times 10^{-4} \text{ m}^2$
	FHF05SC-85X85 $47.70 \times 10^{-3} \text{ m}^2$
Sensing area length and width	
	FHF05SC-50X50 $(36 \times 36) \times 10^{-3} \text{ m}$
	FHF05SC-85X85 $(70 \times 71) \times 10^{-3} \text{ m}$
Sensor passive guard area	
	FHF05SC-50X50 $12.04 \times 10^{-4} \text{ m}^2$
	FHF05SC-85X85 $22.55 \times 10^{-4} \text{ m}^2$
Guard width to thickness ratio	

	FHF05SC-50X50	17.5
	FHF05SC-85X85	18.25
Sensor thickness		0.7×10^{-3} m
Sensor thermal resistance		24×10^{-4} K/(W/m ²)
Sensor thermal conductivity		0.29 W/(m·K)
Response time (95 %)		6 s
Sensor resistance range per dimension		
	FHF05SC-50X50	200 – 300 Ω
	FHF05SC-85X85	800 – 1300 Ω
Required sensor power		zero (passive sensor)
Temperature sensor		type T thermocouple
Temperature sensor accuracy		± 5 % (of temperature in °C), see appendix 7.8 for directions how to reduce the uncertainty to ± 2 % which is the normal specification for Class 2 thermocouples
Standard cable length		2 m
Optional cable length		0, 5 or 10 m
Wiring		7 x copper and 1 x constantan wire, AWG 28, solid core, bundled with a PFA sheath
Cable diameter		2.7×10^{-3} m
Marking		dot on foil indicating front side of the heat flux sensor; 1 x label at the end of FHF05SC's cable, showing serial number and sensitivity
IP protection class		IP67
Rated operating relative humidity range		0 to 100 %
Use under water		FHF05SC is not suitable for continuous use under water
Gross weight including 2 m wires		approx. 0.5 kg
Net weight including 2 m wires		approx. 0.5 kg

HEATER

Heater length and width per dimension		
	FHF05SC-50X50	$(48 \times 47.6) \times 10^{-3}$ m
	FHF05SC-85X85	$(83 \times 82.6) \times 10^{-3}$ m
Heater area		
	FHF05SC-50X50	2381×10^{-6} m ²
	FHF05SC-85X85	7022×10^{-6} m ²
Passive guard area		
	FHF05SC-50X50	2152×10^{-4} m ²
	FHF05SC-85X85	3692×10^{-4} m ²
Heater resistance (nominal) per dimension (measured value supplied with each sensor in the production report)		
	FHF05SC-50X50	120 Ω
	FHF05SC-85X85	40 Ω
Heater rated power supply		24 VDC
Heater power supply		12 VDC (nominal)
Suggested current sensing resistor		10 Ω ± 0.1 %, 0.25 W, < 15 ppm/°C

SELF-TEST

Power consumption during heating interval (nominal)		
	FHF05SC-50X50	1.20 W (@ 12 VDC)
	FHF05SC-85X85	3.60 W (@ 12 VDC)
Nominal heat flux at 12 VDC per dimension		
	FHF05SC-50X50	500 W/m ²
	FHF05SC-85X85	500 W/m ²

INSTALLATION AND USE

Typical conditions of use		in experiments, in measurements in laboratory and industrial environments. Exposed to heat fluxes for periods of several minutes to several years.
---------------------------	--	--

	Connected to user-supplied data acquisition equipment. Regular inspection of the sensor. Continuous monitoring of sensor temperature. No special requirements for immunity, emission, chemical resistance.
Recommended number of sensors	2 per measurement location
Installation	see recommendations in this user manual
Bending	see chapter on installation on curved surfaces
Wire extension	see chapter on cable extension or order sensors with longer cable length

CALIBRATION

Calibration traceability	to SI units
Product certificate	included (showing calibration result and traceability)
Calibration method	method HFPC, according to ASTM C1130 - 21
Calibration hierarchy	from SI through international standards and through an internal mathematical procedure
Calibration uncertainty	$< \pm 5\%$ ($k = 2$)
Recommended recalibration interval	2 years
Calibration reference conditions	20 °C, heat flux of 300 (model -50X50) or 600 (model -85X85) W/m ² , mounted on aluminium heat sink, thermal conductivity of the surrounding environment 0.0 W/(m·K)
Validity of calibration	based on experience the instrument sensitivity will not change during storage. During use the instrument "non-stability" specification is applicable. When used under conditions that differ from the calibration reference conditions, the FHF05SC sensitivity to heat flux may be different than stated on its certificate. See the chapter on instrument principle and theory for suggested solutions
Field calibration	is possible by comparison to a calibration reference sensor. Usually mounted side by side, alternative on top of the field sensor. Preferably reference and field sensor of the same model and brand. Typical duration of test > 24 h

MEASUREMENT ACCURACY

Uncertainty of the measurement	statements about the overall measurement uncertainty can only be made on an individual basis.
--------------------------------	---

VERSIONS / OPTIONS

With longer cable length	option code = cable length in metres
With black sticker applied	BLK sticker applied to the sensor at the factory to absorb radiation
With gold sticker applied	GLD sticker applied to the sensor at the factory to reflect radiation

ACCESSORIES

Hand-held read-out unit	LI19 handheld read-out unit / datalogger NOTE: LI19 does not measure temperature, only heat flux and does not support self-test functionality
Separate black stickers	BLK sticker to absorb radiation, to be applied by the user
Separate gold sticker	GLD sticker to reflect radiation, to be applied by the user

3.2 Dimensions of FHF05SC series

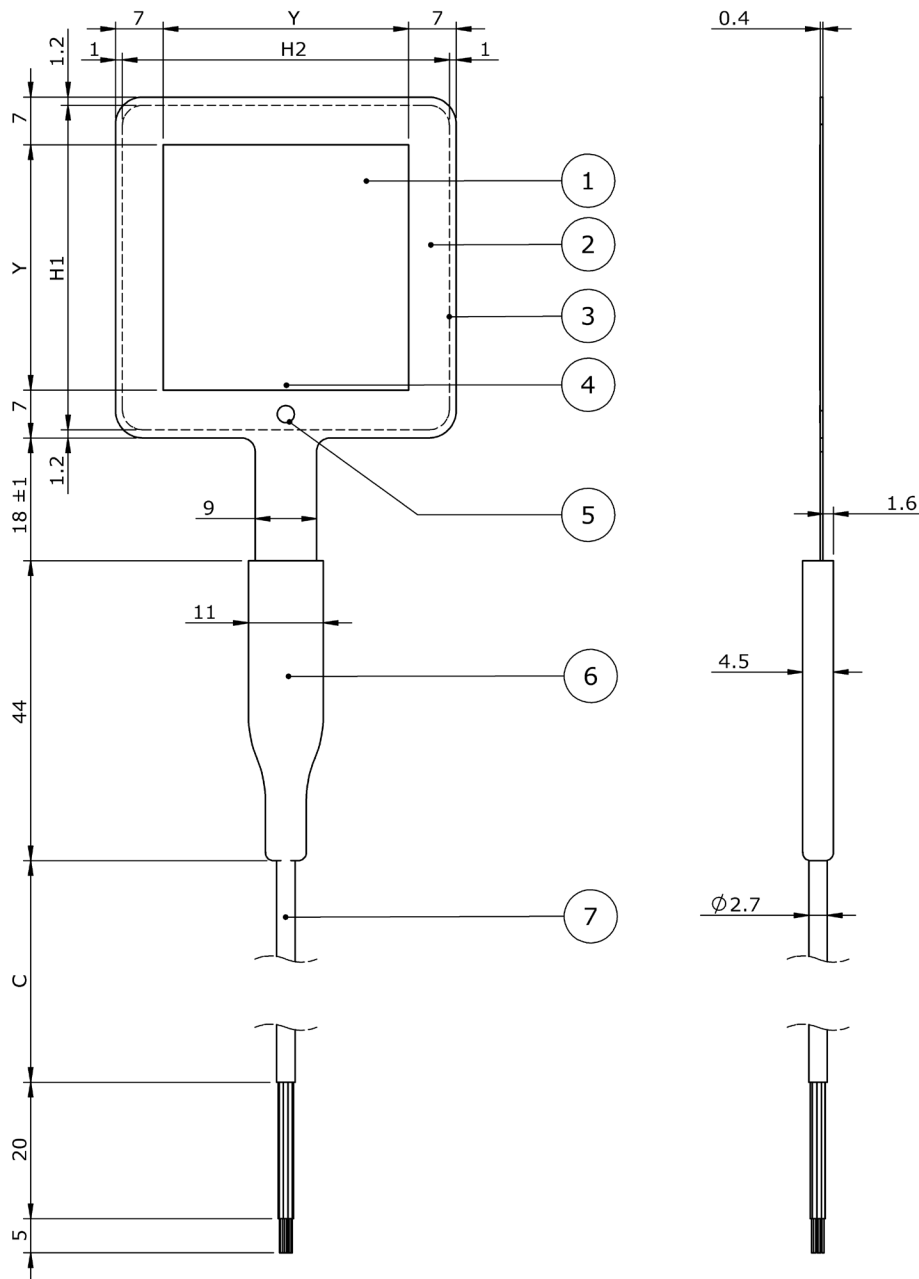

Figure 3.2.1 FHF05SC series models -50X50 and -85X85 heat flux sensor; $Y = 36$ or 70 , $H1 = 47.6$ or 82.6 and $H2 = 48$ or 83 . All dimensions in $\times 10^{-3}$ m

- (1) sensing area with thermal spreaders
- (2) passive guard
- (3) contour of the heater area for self-test
- (4) type T thermocouple
- (5) dot indicating front side
- (6) connection block for strain relief
- (7) wires, standard length $C = 2$ m

4 Standards and recommended practices for use

FHF05SC series should be used in accordance with recommended practices.

4.1 Heat flux measurement in industry

FHF05SC series sensors are often used to measure on industrial walls and metal surfaces, estimating the installation's energy balance and the thermal transmission of walls. Typically, the total measuring system consists of multiple heat flux- and temperature sensors. In many cases heat flux sensors are used for trend-monitoring. In such cases reproducibility is more important than absolute measurement accuracy.



Figure 4.1.1 Example of model FHF05SC-85X85 foil heat flux sensor being installed for measurement on an object. The sensor is mounted on a well-prepared flat surface.

5 Installation of FHF05SC series

5.1 Site selection and installation

Table 5.1.1 Recommendations for installation of FHF05SC series heat flux sensors.

Location	choose a location that is representative of the process that is analysed if possible, avoid exposure to sun, rain, etc. do not expose to drafts and lateral heat fluxes do not mount in the vicinity of thermal bridges, cracks, heating or cooling devices and fans
Performing a representative measurement	we recommend using > 2 sensors per measurement location. This redundancy also improves the assessment of the measurement accuracy
Mounting	when mounting a FHF05SC model, keep the directional sensitivity in mind orient the heater away from the object on which it is mounted heat flux from the back side (side with heater) to the front side (side with dot) generates a positive voltage output signal fix the connection block to the object of interest so that the temperature or the connection block remains as close as possible to that of the heat flux sensor. This is a way to achieve the highest accuracy temperature measurement (see appendix).
Surface cleaning and levelling	create a clean and smooth surface of at least the outer dimensions of the sensor in use
Mechanical mounting: avoiding strain on the sensor to wire transition	during installation as well as operation, the user should provide proper strain relief on the cable so that the connection block is not exposed to significant force first install the sensor by providing strain relief on the connection block and after that install the wires including additional strain relief
Short term installation	avoid any air gaps between sensor and surface. Air thermal conductivity is in the 0.02 W/(m·K) range, while a common glue has a thermal conductivity around 0.2 W/(m·K). A 0.1×10^{-3} m air gap increases the effective thermal resistance of the sensor by 200 % to avoid air gaps, we recommend thermal paste or glycerol for short term installation use tape to fixate the sensor on the surface. If possible, tape only over the passive guard area (surrounding the sensing area). See Figure 3.2.1 use tape to fixate the connection block of the sensor usually, the cable is fixated with an additional strain relief, for example using a cable tie mount as in Figure 5.1.1
Permanent installation	for long-term installation fill up the space between sensor and object with silicone construction sealant, silicone glue or silicone adhesive, that can be bought at construction depots. we discourage the use of thermal paste for permanent installation because it tends to dry out. silicone glue is more stable and reliable
Signal amplification	see the paragraph on electrical connection

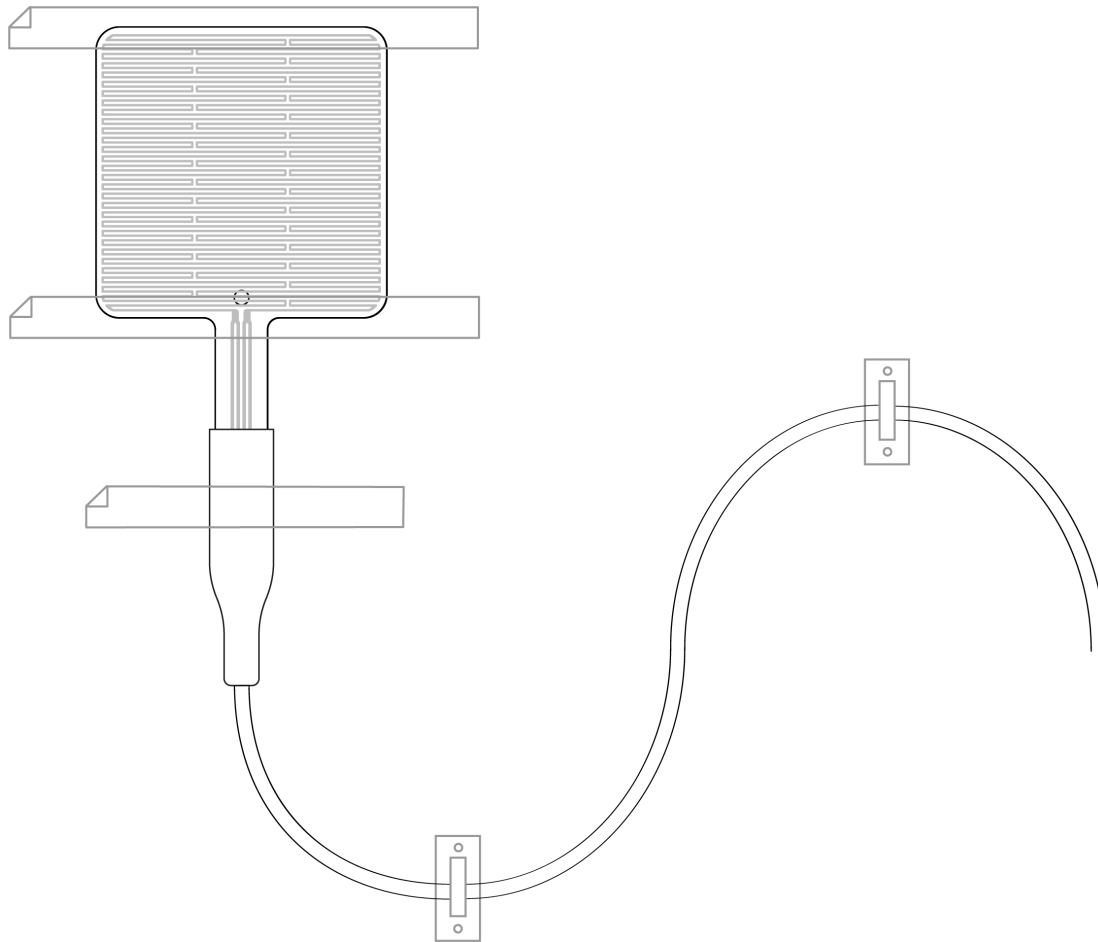

Figure 5.1.1 *Installation of model FHF05SC-50X50 using tape to fixate the sensor and the connection block. Extra strain relief on the wires is provided using cable tie mounts equipped with double sided tape as adhesive. As indicated in Table 5.1.1, tapes fixating the sensor are preferably taped over the passive guard area and not on the sensing area (the latter indicated by grey shading in Figure 5.1.1). Please note we are viewing the back side (heater side) and that the other side, the front side, is attached on the object on which the sensor is mounted, as explained in Chapter 2.*

See also our application note on [how to install a heat flux sensor](#).

5.2 Installation on curved surfaces

The flexibility of the FHF05SC series makes it perfectly suitable to be installed on singly curved surfaces. The sensor can be bent around any axis.



Figure 5.2.1 *Bending of model FHF05SC-50X50 foil heat flux sensor, in this image on a pipe.*

When measuring on curved surfaces, the same recommendations of the previous chapter apply, except that the use of thermal paste is recommended over glycerol. For installation on curved surfaces, it is usually not achievable to tape only over the passive guard area. Use sufficient tape to make sure the sensor remains fixed and in good thermal contact with curved surface. Avoid air gaps. Tape can be used over the sensing area when necessary.

Table 5.2.1 *Extra recommendations for installation of FHF05SC series foil heat flux sensors on curved surfaces.*

Bending	Sensor can be bent in both directions
Rated bending radius	$\geq 15 \times 10^{-3} \text{ m}$
Effect on sensitivity	No significant influence on sensitivity

5.3 Electrical connection

5.3.1 Normal connection

FHF05SC series has one bundled cable. It contains two sets of wires, one set for the heat flux signal, and one set for the heater. The latter are yellow, purple, pink and green.

To read out the heat flux sensor, FHF05SC series should be connected to a measurement system, such as a voltmeter, an amplifier, a datalogger or a data-acquisition (DAQ) system. The FHF05SC series electrical connections are explained in Table 5.4.1.1.

FHF05SC series heat flux sensor is a passive sensor that does not require any power. FHF05SC's heater does require power.

Wires may pick up capacitive noise, which can lead to signal distortion. Therefore, we recommend keeping the electrical connections between the measurement system and the FHF05SC series as short as possible and to keep the signal wires close to each other. For instructions on wire extension please refer to Appendix 7.1.

Table 5.3.1.1 *The electrical connection of FHF05SC series.*

WIRE	FHF05SC
Red	heat flux signal [+]
Black	heat flux signal [-]
White	thermocouple type T [-]
Brown	thermocouple type T [+]
Yellow	heater power [+]
Purple	heater measure [+]
Pink	heater power [-]
Green	heater measure [-]

The sensor serial number and sensitivity of the individual sensors are shown on the FHF05SC series product certificate and at the end of FHF05SC's cable.

NOTICE
Putting more than 24 Volt across the sensor wiring can lead to permanent damage to the sensor.

To apply power to the FHF05SC series heater, it should be connected to a 12 V power supply.

To measure the power P_{heater} , the heater can be connected in several different ways, measuring:

- heater voltage and current, $P_{\text{heater}} = U_{\text{heater}} \cdot I_{\text{heater}}$ (Formula 5.3.1.1)
- heater voltage and known heater resistance, $P_{\text{heater}} = U_{\text{heater}}^2 / R_{\text{heater}}$ (Formula 5.3.1.2)

- heater current and known heater resistance, $P_{\text{heater}} = I_{\text{heater}}^2 \cdot R_{\text{heater}}$ (Formula 5.3.1.3)

To apply a variable controlled heat flux, the heater can either be connected via a solid-state relay controlled by a pulse-width modulated (PWM) signal or to a 0 – 12 V programmable power supply. The power generated by the heater can be accurately measured by making a four-point measurement. To this end the heater has a four-wire connection.

5.3.2 Increasing sensitivity, connecting multiple sensors in series

Multiple sensors may be electrically connected in series. The resulting sensitivity is the sum of the sensitivity of the individual sensors. Below the equations in case two sensors are used. If needed, more than two sensors may be put in series, again increasing the sensitivity.

$$\Phi = U / (S_1 + S_2) \quad \text{(Formula 5.3.2.1)}$$

and

$$U = U_1 + U_2 \quad \text{(Formula 5.3.2.2)}$$

Table 5.3.2.1 *The electrical connection of two FHF05SC series models, 1 and 2, in series. In such case the sensitivity is the sum of the two sensitivities of the individual sensors. More sensors may be added in a similar manner.*

SENSOR	WIRE		MEASUREMENT SYSTEM
1	Red	signal 1 [+]	voltage input [+]
1	Black	signal 1 [-]	connected to signal 2 [+]
1	Brown	thermocouple type T [+]	
1	White	thermocouple type T [-]	
2	Red	signal 2 [+]	connected to signal 1 [-]
2	Black	signal 2 [-]	voltage input [-] or ground
2	Brown	thermocouple type T [+]	
2	White	thermocouple type T [-]	

The serial number and sensitivity of the individual sensors are shown on the FHF05SC series product certificate and on the sticker.

5.3.3 Connection to read out half signals

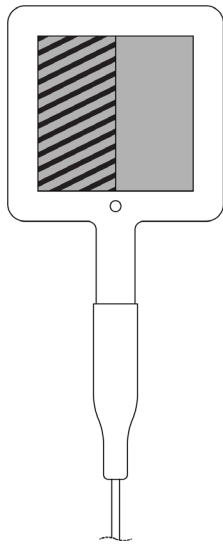

See the figure on the left: FHF05SC series can be connected to read out only the heat flux through the left half of the sensing area or the heat flux through the right half of the sensing area. This feature may be used for quality assurance purposes; if the sensor is correctly installed, a constant percentage of the signal will be generated by the left – and right.

Figure 5.3.3.1 FHF05SC-50X50 with left half indicated by diagonal lines.

Table 5.3.3.1 The electrical connection of FHF05SC series for 100 % signal.

WIRE	MEASUREMENT SYSTEM	
Red	heat flux signal [+]	voltage input [+]
Black	heat flux signal [-]	voltage input [-] or ground
Brown	thermocouple type T [+]	
White	thermocouple type T [-]	

Table 5.3.3.2 The electrical connection of FHF05SC series for left 50 % signal.

WIRE	MEASUREMENT SYSTEM	
Red	heat flux signal [+]	voltage input [+]
Black	heat flux signal [-]	
Brown	thermocouple type T [+]	voltage input [-] or ground
White	thermocouple type T [-]	

Table 5.3.3.3 The electrical connection of FHF05SC series for right 50 % signal.

WIRE	MEASUREMENT SYSTEM	
Red	heat flux signal [+]	
Black	heat flux signal [-]	voltage input [-] or ground
Brown	thermocouple type T [+]	voltage input [+]
White	thermocouple type T [-]	

5.4 Requirements for data acquisition / amplification

The selection and programming of dataloggers is the responsibility of the user. Please contact the supplier of the data acquisition and amplification equipment to see if directions for use with the FHF05SC series are available. In case a program for similar instruments is available, this can be used. FHF05SC series can be treated in the same way as other heat flux sensors and (analogue) thermopile pyranometers.

NOTICE

Do not use "open circuit detection" when measuring the sensor output.

Table 5.4.1 Requirements for data acquisition and amplification equipment for FHF05SC series in the standard configuration.

Capability to measure small voltage signals	preferably: $< 5 \times 10^{-6}$ V uncertainty minimum requirement: 20×10^{-6} V uncertainty (valid for the entire expected temperature range of the acquisition / amplification equipment)
Capability for the data logger or the software	to store data, and to perform division by the sensitivity to calculate the heat flux. $\Phi = U/S$
Capability to measure thermocouple type T	preferably: $< \pm 3$ °C uncertainty
Data acquisition input resistance	$> 1 \times 10^6 \Omega$
Open circuit detection (WARNING)	open-circuit detection should not be used, unless this is done separately from the normal measurement by more than 5 times the sensor response time and with a small current only. Thermopile sensors are sensitive to the current that is used during open circuit detection. The current will generate heat, which is measured and will appear as a temporary offset.

6 Maintenance and trouble shooting

6.1 Recommended maintenance and quality assurance

FHF05SC series measures reliably at a low level of maintenance. Unreliable measurement results are detected by scientific judgement, for example by looking for unreasonably large or small measured values. The preferred way to obtain a reliable measurement is a regular critical review of the measured data, preferably checking against other measurements.

Table 6.1.1 *Recommended maintenance of FHF05SC series. If possible, the data analysis is done daily.*

MINIMUM RECOMMENDED HEAT FLUX SENSOR MAINTENANCE			
	INTERVAL	SUBJECT	ACTION
1	1 week	data analysis	compare measured data to the maximum possible or maximum expected heat flux and to other measurements for example from redundant instruments. Look for any patterns and events that deviate from what is normal or expected. Compare to acceptance intervals.
2	6 months	inspection	inspect wire quality, inspect mounting, inspect location of installation
3	2 years	recalibration	recalibration by comparison to a calibration standard instrument in the field, see Paragraph 6.3. recalibration by the sensor manufacturer
4	2 years	lifetime assessment	judge if the instrument will be reliable for another 2 years, or if it should be replaced

6.2 Trouble shooting

Table 6.2.1 *Trouble shooting for FHF05SC series.*

General	<p>Inspect the sensor for any damage. Inspect the quality of mounting / installation. Inspect if the wires are properly attached to the data logger.</p> <p>Check the condition of the wires.</p> <p>Check the datalogger program in particular if the right sensitivity is entered. FHF05SC series sensitivity and serial number are shown on the product certificate and on the sticker.</p> <p>Check if the correct thermocouple type is chosen in the datalogger program. See specifications table 3.1.1 for the nominal sensitivities per dimension. Measure the sensor resistance first with one polarity, then reverse the polarity. Take the average value. The typical resistance of the wiring is 0.3 Ω/m. Typical resistance should be the nominal sensor resistances stated in table 3.1.1 plus 0.6 Ω for the total resistance of two wires (back and forth) of each m. Infinite resistance indicates a broken circuit; zero or a lower than 1 Ω resistance indicates a short circuit.</p>
The sensor does not give any signal	<p>Check if the sensor reacts to heat: put the multimeter at its most sensitive range of DC voltage measurement, typically the 100 x 10⁻³ VDC range or lower. Expose the sensor to heat. Exposing the back side (the side with the heater) to heat should generate a positive signal between the red [+] and black [-] wires, doing the same at the front side (the side with the dot), the sign of the output reverses. Check the data acquisition by replacing the sensor with a spare unit.</p>
The sensor signal is unrealistically high or low	<p>Check the wire condition.</p> <p>Check the data acquisition by applying a 1 x 10⁻⁶ V source to it in the 1 x 10⁻⁶ V range. Look at the measurement result. Check if it is as expected.</p> <p>Check the data acquisition by short circuiting the data acquisition input with a 10 Ω resistor. Look at the output. Check if the output is close to 0 W/m².</p>
The sensor signal shows unexpected variations	<p>Check the presence of strong sources of electromagnetic radiation (radar, radio).</p> <p>Check the condition of the sensor wires.</p> <p>Check if the wires are not moving during the measurement.</p>
The temperature measurement shows unrealistic values	<p>Check if the correct thermocouple type (Type T) is chosen in the datalogger program</p> <p>Check if a correct reference temperature is chosen in the program</p> <p>Check the electrical resistance of the thermocouple between the brown [+] and white [-] wires. Use a multimeter at the 100 Ω range. Measure the thermocouple resistance first with one polarity, then reverse the polarity. Take the average value. The typical resistance of the copper wiring is 0.3 Ω/m, for the constantan wiring this is 6.5 Ω/m. Typical resistance should be the nominal thermocouple resistance of 2.5 Ω plus 6.8 Ω for the total resistance of the two wires of each metre (back and forth). Infinite resistance indicates a broken circuit; zero or a lower than 1 Ω resistance indicates a short circuit.</p> <p>Make sure the temperature of the connection block remains as close as possible to that of the heat flux sensor. See appendix on temperature measurement accuracy for more information.</p>
Check heater	<p>Check the electrical resistance between the yellow and purple wires. These resistances should be in the 0.1 Ω/m range, so 0.2 Ω in case of the standard 2 m wire length. Higher resistances indicate a broken circuit. Repeat this measurement for the pink and green wire.</p> <p>Check the resistance between the yellow or purple wires and the green or pink wires.</p> <p>Use a multimeter at the 1 kΩ range. Typical resistance should be around 100 Ω. Infinite resistance indicates a broken circuit; zero or a lower than 1 Ω resistance indicates a short circuit.</p>

6.3 Calibration and checks in the field

The recommended calibration interval of heat flux sensors is 2 years.
Recalibration of field heat flux sensors is ideally done by the sensor manufacturer.

On-site field calibration is possible by comparison to a calibration reference sensor.
Usually mounted side by side, alternatively mounted on top of the field sensor.

Hukseflux main recommendations for field calibrations are:

- 1) to compare to a calibration reference of the same brand and type as the field sensor
- 2) to connect both to the same electronics, so that electronics errors (also offsets) are eliminated
- 3) to mount all sensors on the same platform, so that they have the same body temperature
- 4) typical duration of test: > 24 h
- 5) typical heat fluxes used for comparison: > 200 W/m²
- 6) to correct deviations of more than ± 20 %. Lower deviations should be interpreted as acceptable and should not lead to a revised sensitivity

Users may also design their own calibration experiment, using the integrated heater

7 Appendices

7.1 Appendix on cable extension

FHF05SC series is equipped with a cable with eight wires. Standard cable length is 2 m. It is possible to order FHF05SC series with longer cable lengths.

Cables may act as a source of distortion by picking up capacitive noise. Keep the distance between data logger or amplifier and sensor as short as possible.

In an electrically “quiet” environment the FHF05SC series wires may be extended without problem. If done properly, the sensor signal, although small, will not significantly degrade because the sensor resistance is very low (which results in good immunity to external sources) and because there is no current flowing (so no resistive losses).

Wire and connection specifications are summarised below.

Table 7.1.1 Preferred specifications for cable extension of FHF05SC series.

Wire	7x copper and 1 x constantan wire, AWG 28, stranded, solid core, bundled with a PFA sheath
Separate cable	Available in 2, 5 or 10 m length
Extension sealing	make sure any connections are sealed against humidity ingress
Conductor resistance	< 0.3 Ω /m (copper wire)
Outer cable diameter	typically 2.7×10^{-3} m
Length	wires should be kept as short as possible, in any case the total wire length should be less than 100 m
Connection	either use gold plated waterproof connectors, or solder the new wire conductors and shield to those of the original sensor wire, and make a waterproof connection using heat-shrink tubing with hot-melt adhesive when using connectors, use dedicated type T thermocouple connectors for extending the thermocouple wires

7.2 Appendix on using FHF05SC series with BLK – GLD sticker series

BLK black and GLD gold stickers are accessories to FHF05 series and FHF05SC series heat flux sensors. A sensor equipped with a BLK black sticker is sensitive to both radiative and convective heat flux. A sensor equipped a GLD gold sticker reflects radiation and measures convective heat flux only. To calculate the radiative heat flux, subtract the two measurements.

There are BLK – GLD stickers for every sensor in FHF05 series and FHF05SC series.

BLK - GLD stickers are designed to be applied by the user. Optionally, it is also possible to order FHF05(SC) with stickers pre-applied at the factory. For more details, see the BLK – GLD sticker series user manual.

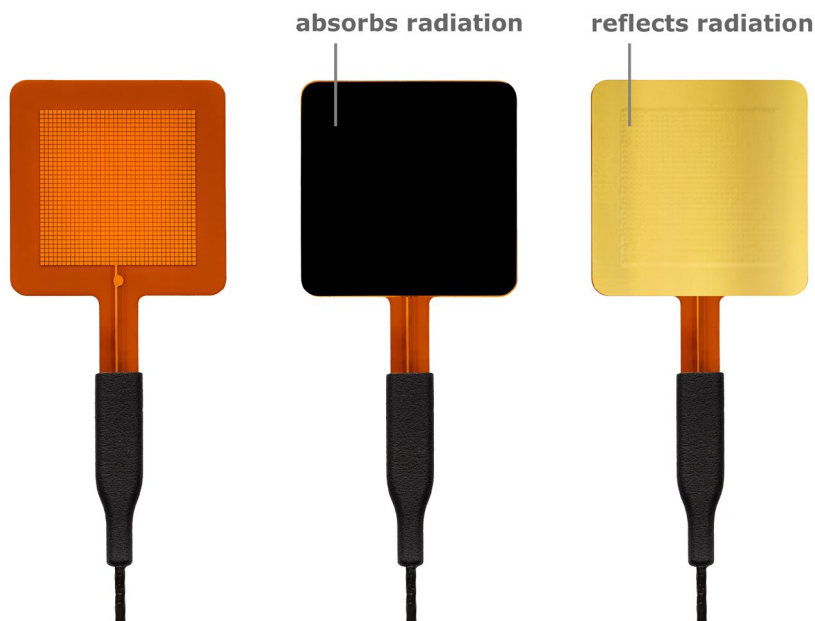

Figure 7.2.1 Models FHF05SC-50X50 heat flux sensor: with BLK-5050 and GLD-5050 stickers.

Table 7.2.1 Recommendations for use of FHF05SC heat flux sensors with BLK – GLD stickers.

Mounting	when mounting an FHF05SC with a BLK or GLD sticker, keep the directional sensitivity in mind heat flux from the back side to the front side (side with dot, side without the heater) generates a positive voltage output signal.
Mounting on curved surfaces	apply BLK – GLD stickers before mounting the sensor
Location	avoid direct exposure to the sun
Effect on sensitivity	BLK-GLD stickers have no significant influence on sensitivity

7.3 Appendix on standards for calibration

The standard ASTM C1130 – 21 Standard Practice for Calibrating Thin Heat Flux Transducers specifies in chapter 6 that a guarded hot plate, a heat flowmeter, a hot box or a thin heater apparatus are all allowed. Hukseflux employs a thin heater apparatus, uses a linear function according to X1.1 and uses a nominal temperature of 20 °C, in accordance with X2.2.

The Hukseflux HFPC method relies on a thin heater apparatus according to principles as described in Paragraph 4 of ASTM C1114 - 06, used in the single sided mode of operation described in Paragraph 8.2 and in ASTM C1044 - 16.

ISO does not have a dedicated standard practice for heat flux sensor calibration. We follow the recommended practice of ASTM C1130 - 21.

Table 7.3.1 Heat flux sensor calibration according to ISO and ASTM.

STANDARDS ON INSTRUMENT CLASSIFICATION AND CALIBRATION	
ISO STANDARD	EQUIVALENT ASTM STANDARD
no dedicated heat flux calibration standard available.	<p>ASTM C1130 - 21 Standard Practice for Calibrating Thin Heat Flux Transducers</p> <p>ASTM C 1114 - 06 Standard Test Method for Steady-State Thermal Transmission Properties by Means of the Thin-Heater Apparatus</p> <p>ASTM C1044 - 16 Standard Practice for Using a Guarded-Hot-Plate Apparatus or Thin-Heater Apparatus in the Single-Sided Mode</p>

7.4 Appendix on calibration hierarchy

FHF05SC series factory calibration is traceable from SI through international standards and through an internal mathematical procedure that corrects for known errors. The formal traceability of the generated heat flux is through voltage and current to electrical power and electric power and through length to surface area.

The Hukseflux HFPC method follows the recommended practice of ASTM C1130 - 21. It relies on a thin heater apparatus according to principles as described in paragraph 4 of ASTM C1114 - 06, in the single sided mode of operation described in paragraph 8.2 and in ASTM C1044 - 16. The method has been validated in a first-party conformity assessment, by comparison to calibrations in a guarded hot plate.

7.5 Appendix on correction for temperature dependence

The sensitivity of a FHF05SC series depends on the temperature of the sensor. The temperature dependence of the FHF05SC series is specified as $< 0.2 \text{ \%/}^\circ\text{C}$.

The calibration reference temperature is $20 \text{ }^\circ\text{C}$.

Users that measure at temperatures that deviate much from $20 \text{ }^\circ\text{C}$, or users that measure over a wide range of temperatures, may wish to correct for this temperature dependence.

To correct for the temperature dependence of the sensitivity, use the measurement function

$$\Phi = U / (S \cdot (1 + 0.002 \cdot (T - 20))) \quad (\text{Formula 7.5.1})$$

with Φ the heat flux in W/m^2 , U the FHF05SC series voltage output in V , S the sensitivity in $\text{V}/(\text{W/m}^2)$ at $20 \text{ }^\circ\text{C}$ and T the FHF05SC temperature.

S is shown on the product certificate and at the end of FHF05SC's cable.

7.6 Appendix on measurement range for different temperatures

The measurement range of FHF05SC series is specified as $(-10 \text{ to } +10) \times 10^3 \text{ W/m}^2$ at 20 °C heat sink temperature. This is a very conservative specification.

In reality, the rated operating temperature continuous range of +120 °C is the limiting specification. The sensor temperature T in °C in a specific application depends on the heatsink temperature T_{heatsink} in °C, the heat flux Φ in W/m^2 and the thermal resistance per unit area $R_{\text{thermal,A}}$ of the sensor in $\text{K}/(\text{W/m}^2)$.

$$T = T_{\text{heatsink}} + \Phi \cdot R_{\text{thermal,A}} \quad (\text{Formula 7.6.1})$$

This means the measurement range is lower for higher heat sink temperatures.

$$\Phi_{\text{maximum}} = (120 - T_{\text{heatsink}}) / R_{\text{thermal,A}} \quad (\text{Formula 7.6.2})$$

Table 7.5.1 shows measurement ranges for different heat sink temperatures. For applications where the sensor is not mounted on a heatsink, use the ambient temperature instead of heatsink temperature.

Table 7.6.1 Measurement range for different heat sink temperatures.

HEATSINK TEMPERATURE	MEASUREMENT RANGE
20 °C	$43 \times 10^3 \text{ W/m}^2$
40 °C	$35 \times 10^3 \text{ W/m}^2$
60 °C	$26 \times 10^3 \text{ W/m}^2$
80 °C	$18 \times 10^3 \text{ W/m}^2$
100 °C	$9 \times 10^3 \text{ W/m}^2$

7.7 Appendix on temperature measurement accuracy

All FHF05SC's have an integrated thermocouple to measure temperature of the object under test. This thermocouple is supplied as a secondary measurement, in addition to the main heat flux measurement.

Expanded uncertainty

The total measurement uncertainty is the sum of the thermocouple measurement uncertainty + the cold junction uncertainty. The cold junction uncertainty can be found in the specifications of electronics. Typically, this is ± 1 °C.

Thermocouple measurement uncertainty

The FHF05SC series has a cable with thermocouple extension wires specified as a type T thermocouple, IEC 60584-1:2013 class 2. They consist of a brown positive copper (Cu) wire and a negative white constantan (Cu₅₅Ni₄₅) wire. Accuracy is ± 2 % for temperature differences between T₂ and T₃ (see figure 7.8.1).

In the FHF05SC sensor itself, the thermocouple junction (T₁) consists of copper and constantan traces that are extended from the connection block to the edge of the heat flux sensor sensitive area. These traces have slightly different Seebeck coefficients compared to the wires, which results in a higher measurement uncertainty of ± 5 % for temperature differences between T₁ and T₂ junctions.

Take home: make sure T₁ = T₂. If that is the case then:

$$u_c(T_1) = \text{cold junction} + 2\% (\Delta T_1 + \Delta T_2)$$

The total expanded uncertainty in T₁ (U_c(T₁) in °C, coverage factor of 2) based on the of uncertainty in the measurement of the temperature differences between T₁ and T₂, ΔT_1 , and between T₂ and T₃ or ΔT_2 and the error in their Seebeck coefficients.

If T₁ \neq T₂ the combined standard uncertainty can be calculated by the law of propagation of uncertainty:

$$u_c(T_1) = 5\% \cdot \Delta T_1 + 2\% \cdot \Delta T_2 \quad (\text{Formula 7.8.1})$$

For simplicity, the worst-case scenario of ± 5 % accuracy of the absolute temperature measurement in °C is given as specification for the measurement uncertainty.

It is clear from formula 7.8.1 that the accuracy is best, i.e., in the 2 % range, T₁ is kept close to the temperature T₂. If the temperature measurement is critical, consider using a separate temperature sensor.

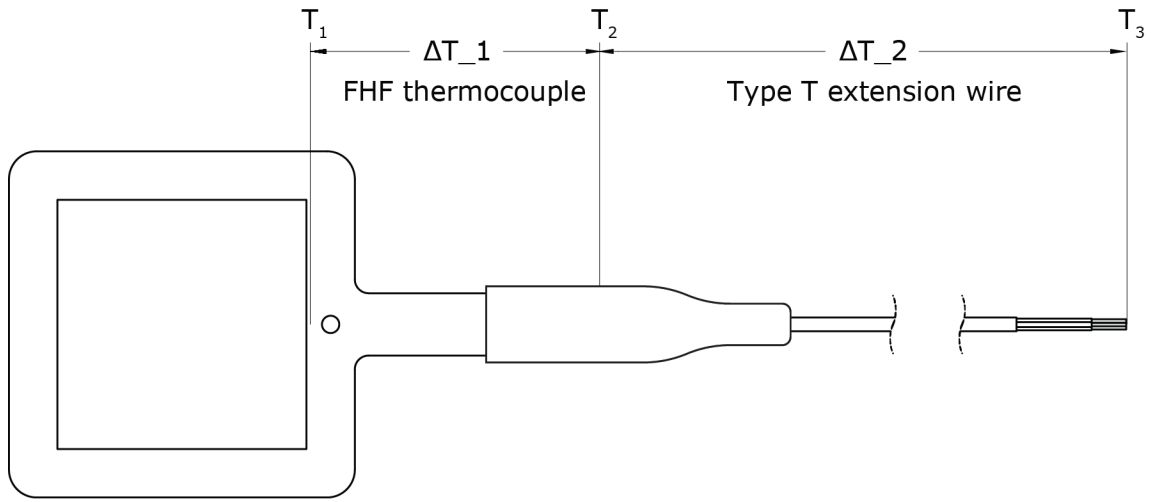

Figure 7.7.1 Model FHF05SC-50X50 with its thermocouple junctions. To minimise uncertainty, please make sure that ΔT_1 is close to zero.

7.8 EU declaration of conformity



We, Hukseflux Thermal Sensors B.V., Delftechpark 31, Delft,
The Netherlands

hereby declare under our sole responsibility that:

Product model FHF05SC series, all models
Product type foil heat flux sensor

is in conformity with the following directives:

2011/65/EU, EU 2015/863 The Restriction of Hazardous Substances Directive

This conformity is declared using the relevant sections and requirements of the following standards:

Hazardous substances RoHS 2 and 215/863 amendment known as RoHS 3

A handwritten signature in blue ink, appearing to be 'E. Hoeksema', written over a faint, light blue grid background.

Eric HOEKSEMA
Director
Delft, 15 November 2022

