



A **Halma** company

The Fastest Flow Controller Company in the World!

OPERATING MANUAL

MC · MCW · MCR · MCV



Thank you for purchasing an Alicat flow controller.

If you have any questions about operating it, or if something is not working as expected, please let us know. We are eager to help you in any way possible.

Alicat Scientific, Inc.

info@alicat.com • alicat.com

7641 N Business Park Drive, Tucson, AZ 85743 USA

1-888-290-6060

Serial Number: _____

Next Calibration (Month/Day) : _____

Recalibrate your flow controller every year.

Alicat recommends that you have your flow meter calibrated every year in order to ensure the continued certainty of your readings and extend the Limited Lifetime Warranty. When it's time for your flow meter's annual recalibration, contact us by phone, email or live chat to set it up, or fill out the Service Request Form at alicat.com/service.

NIST

This Alicat device comes with a NIST traceable calibration certificate.

RoHS

This Alicat flow controller conforms to the European Union's Restriction of Use of Hazardous Substances in Electrical and Electronic Equipment (RoHS) Directive 2011/65/EU.

CE

This Alicat flow controller complies with the requirements of the Low Voltage Directive 2014/35/EU and the EMC Directive 2014/30/EU and carries the CE Marking accordingly.



This Alicat flow controller complies with the requirements of the European Union's Waste Electrical & Electronic Equipment (WEEE) Directive 2002/96/EC.

DOC-MANUAL-MC Rev. 0 • 2020.02.05

Introduction

You're busy, and the last thing you want to do is waste time wrestling with your flow controller. We're here to make your life a little easier so you can do what you do best. It's our pleasure to introduce you to your new Alicat:

- **High-accuracy performance for all your gases.** Use your flow controller with any of the 98 or more gases that are part of Gas Select™, **page 34.**
- **Control pressure while monitoring flow rate.** Set the closed loop control algorithm for pressure control, **page 23.**
- **Backlit display with adjustable contrast** is easy to read in direct sunlight. In dimly lit areas, press the Alicat logo to turn on the backlight, **page 7.**
- **Change your STP** to match any standard temperature and pressure reference, **page 38.**
- **Log data to your PC.** Talk to the flow controller serially to capture all flow data for logging and analysis, **page 42.**

This manual covers the following Alicat Scientific instruments:

- **MC, MCP, and MCR-Series** Mass Gas Flow Controllers
- **MCD and MCRD-Series** Dual Valve Mass Gas Flow Controllers
- **MCE and MCES-Series** Mass Gas Flow Controllers
- **MCQ and MCRQ-Series** High Pressure Mass Gas Flow Controllers
- **MCS and MCRS-Series** Anti-Corrosive Mass Gas Flow Controllers
- **MCV and MCVS-Series** Vacuum Mass Gas Flow Controllers
- **MCW and MCRW (WHISPER)**
Low Pressure Drop Mass Flow Controllers

This includes Alicat flow controllers labeled as approved for CSA Class 1 Div 2 and ATEX Class 1 Zone 2 hazardous environments. See **page 60** for Special Conditions regarding the use of CSA/ATEX labeled devices.

Please contact Alicat at 1-888-290-6060 or info@alicat.com if you have any questions regarding the use or operation of this device.

Contents

Quick Start Guide	6
Getting Started	7
Getting to Know Your Alicat	7
Connectors and Buttons	7
The Flow Controller Display	8
Status Messages	8
Mounting	9
Filters	9
Device Ports	9
Connecting Plumbing to Your Gas Flow Controller	10
MCV Controller Operating Notes	11
MCD Dual Valve Controller Operating Notes	12
Power and Signal Connections	13
Standard 8-Pin Mini-DIN Pinout	13
Analog Signals	14
Option: Color TFT Display	15
Navigation and Customization	16
Flow Controller Menu Map	16
Displaying Live Flow Data	17
Choosing Engineering Units	18
Option: Totalized Flow Data and Batch Dispensing	19
Dispensing Gas in Batches	20
Menu	22
Taring Your Flow Controller	22
Control Menus	23
Changing the Setpoint	24
Changing Between Setpoint Sources	24
Changing the Control Loop Variable	24
Establishing Setpoint Limits	25
Using Setpoint Ramping	26
Limiting Flow Rate While Controlling Pressure	28
Adjusting the Closed Loop Controller	29
Using a Control Deadband for MCDs	31

About	32
Diagnostic Information	32
Basic Configuration Menu	33
Choosing Engineering Units from the Basic Configuration	33
Serial Communication	42
Establishing Communications	42
Serial Terminal Application	42
Polling Mode	43
Streaming Mode	43
Taring	44
Collecting Flow Data	44
Commanding a New Setpoint	45
Sending Setpoints as Floating Point Numbers	45
Sending Setpoints as Integers	45
Using Gas Select™ and COMPOSER™	46
Quick Command Guide	47
Troubleshooting	48
Maintenance	51
Gas List	52
Engineering Units	54
Flow Units	54
Pressure Units	55
Optional Pinouts	56
Locking Industrial Connector Pinouts	56
M12 Connector Pinouts	57
9 pin D-Sub Common Pinouts	58
15 pin D-Sub Common Pinouts	59

Quick Start Guide

Setup

- **Connect your flow controller.** Ensure that flow through your device will be in the same direction as the arrow on the flow body (usually left to right).
- **Tare your flow controller.** Before you connect the flow meter, ensure that no air is flowing through the device and give it a zero setpoint for at least 2 seconds. **Note:** Whisper flow controllers are sensitive enough to measure the lightest of breezes, so ensure that one end is plugged before selecting tare.
- **Choose your engineering units.** Press the button above or below any parameter to enlarge it in the middle of the display. If you select that same item a second time, you can change the engineering unit for that parameter. You can choose units for all of the parameters at once by selecting **MENU** → **BASIC CONFIG** → **DEVICE UNITS** (see **page 18**).

Operation: Flow Verification

- **Monitor live flow readings.** You can monitor live readings of flow, pressure, and temperature by viewing the screen. Readings are updated in real time. See **page 17**.
- **Tare your flow controller** before you begin another round of measurements. Ensure that no flow is passing through your controller and wait for it to auto-tare. See **page 22**.
- (Optional) **Capture a totalized reading.** The totalizer option displays the total flow that has passed through the device since the last time the totalizer was reset. Press **TOTAL/MENU** to access the totalizer. See **page 19**.

Backlight

Your Alicat monochrome display comes equipped with a backlight. **To activate the backlight, press the center of the Alicat logo on the front of your device.** To turn the backlight off press the button again. For color displays, pressing this button will turn off the display to conserve power.

Maintenance and Care

- If your gas is clean, your flow meter will require no periodic cleaning. Read more about maintenance on **page 51**.
- Calibrate your flow meter annually. Request an Alicat factory calibration at alicat.com/service or by calling **1-888-290-6060**.

Getting Started

Getting to Know Your Alicat

Connectors and Buttons

The drawings below represent the default configuration of a standard Alicat mass flow controller (MC series) with an upstream valve. **Your flow controller's appearance and connections may differ**, especially if it has been ordered with a large Rolamite valve or a downstream valve.

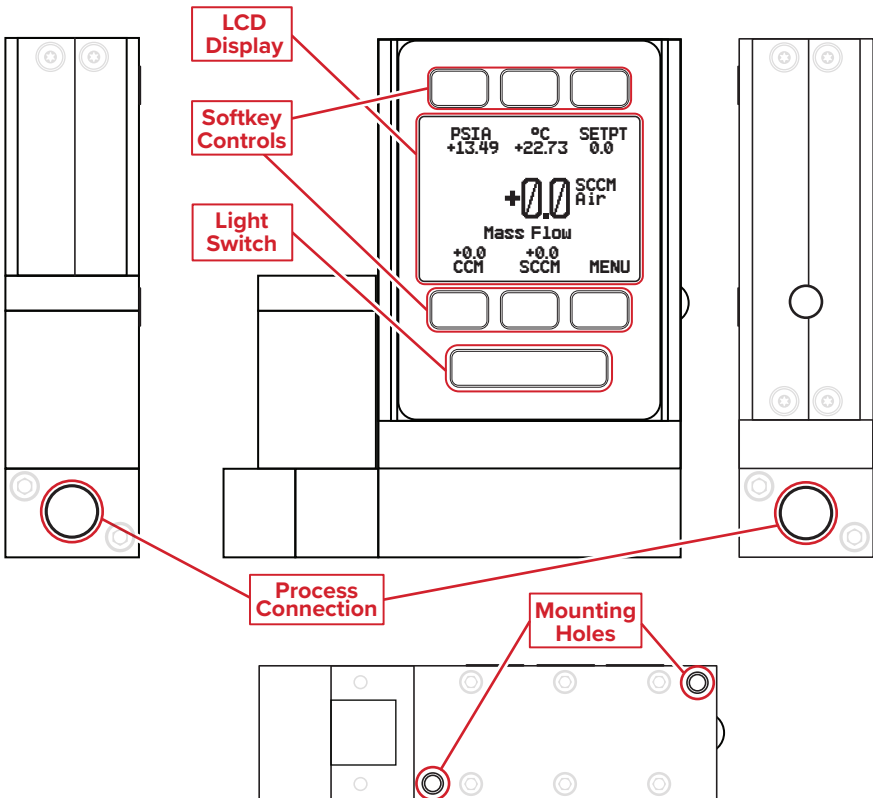
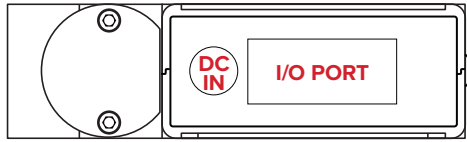

The Flow Controller Display

The figure below identifies the various features of the flow controller display. Press the large button with the Alicat logo to toggle the backlight on and off. For more details, see the Menu Map on **page 16** and the menu-by-menu descriptions that follow it.

Engineering units are used by the controller in its serial communications and calculations. These can be different from **button units**, which are the units being displayed. These are individually configurable. See **page 18**.

- 1 Highlights **pressure** in the center of the meter. Push a second time to choose the pressure parameter (if available), or to select pressure engineering units.
- 2 Highlights **temperature**. Push a second time to select temperature engineering units.
- 3 SETPT sets the **flow or pressure control setpoint** (see **page 24**).
- 4 Highlights **volumetric (actual) flow** rate. Push a second time to select volumetric flow rate engineering units.
- 5 Highlights **mass flow** rate. Push a second time to select mass flow (normal mass flow) or true mass flow engineering units.
- 6 TOTAL Accesses **flow totalizer** (optional) (**page 19**). MENU enters the Menu system (**page 22**)

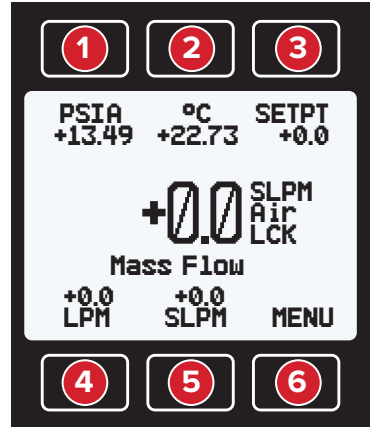

Status Messages

ADC	Analog-digital converter error	OVR	Totalizer rolled over to zero
EXH	Valve exhaust is active	POV	Pressure over range of device
HLD	Valve hold is active	TMF	Totalizer missed out of range flow
LCK	Front display is locked (in the example above)	TOV	Temperature over range of device
MOV	Mass flow over range of device	VOV	Volumetric flow over range of device
OPL	Overpressure limit exceeded (optional)		

Mounting

No straight runs of pipe are required upstream or downstream of the flow controller. Most Alicat flow controllers can be mounted in any position, including upside-down. MCS and MCRS series flow controllers use media-isolated sensors that must be tared after changing orientation.



Caution: *Flow controllers that use large Rolamite valves (MCR, MCRW, MCRQ, MCRS) should be mounted with their valve oriented vertically (right-side up). If another orientation is desired, please contact Alicat.*

Filters

When pressure drop is not an issue, use in-line sintered filters to prevent large particulates from entering the flow controller. Suggested maximum particulate sizes are as follows:

- **5 microns** for units with flow ranges of 1 SCCM or less.
- **20 microns** for units with flow ranges between 2 SCCM and 1 SLPM.
- **50 microns** for units with flow ranges of 1 SLPM or more.

Device Ports

Your controller has been shipped with plastic plugs fitted into its ports. To lessen the chance of contaminating the flow stream, do not remove these plugs until you are ready to install the device.

Standard Alicat Gas Flow controllers have female inlet and outlet ports. Welded VCR and other specialty fittings may have male connections.

- If you are using a fitting that does not have a face seal, use thread-sealing Teflon tape to prevent leakage around the port threads, but do not wrap the first two threads. This will minimize the possibility of getting tape into the flow stream and clogging the laminar flow elements (LFEs).
- If you are using a fitting that has a face seal, there is no need to apply Teflon tape to the threads.



Warning: *It is not recommended to use pipe dopes or sealants on the process connections as these compounds can cause permanent damage to the controller should they get into the flow stream.*

Connecting Plumbing to Your Gas Flow Controller

Your Alicat flow controller can measure and control flow generated by positive pressure and/or suction. Connect the controller so that the flow travels in the same direction as the flow arrow, usually from left to right as you look at the front of the device.

Note: On instruments set up for vacuum or gas mixing, the control valve will be situated in the down-stream position.

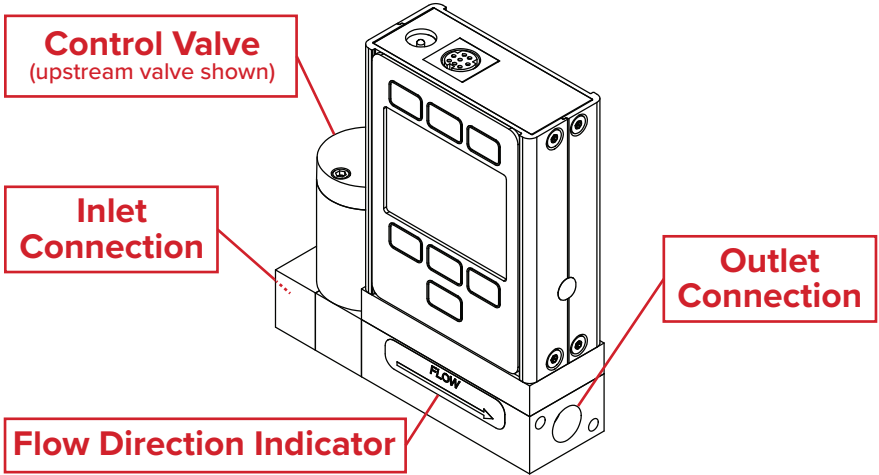

Warning: Using the flow controller above the maximum specified internal line pressure, or above the maximum recommended differential pressure between the inlet and outlet, will result in permanent damage to the internal pressure sensors.

A common cause of this problem is the instantaneous application of high-pressure gas, as from a snap-acting solenoid valve either upstream or downstream of the flow controller. If you suspect that your pressure sensor is damaged, please discontinue use of the device and contact Alicat. See the chart below for pressure limits.

Model	Max Common Mode Pressure	Max Differential Pressure
MC, MCR, MCS, MCE, MCP, MCV	175 PSIA	75 PSID
MCW, MCRW	80 PSIA	15 PSID
MCQ, MCRQ	400 PSIA	75 PSID

MCV Controller Operating Notes

Alicat's MCV mass flow controller is equipped with an integrated Swagelok® positive shutoff valve. The normally closed valve is opened by supplying with 60–120 PSIG of air pressure. The shut-off valve closes again when this pressure is removed.

A common method for actuating the shutoff valve incorporates a three-way solenoid valve (below). Pressure is applied to one side of the solenoid valve while the other side of the solenoid is left open to atmosphere. When the solenoid is energized, pressure is delivered to the shutoff valve, causing it to open. When the solenoid is returned to a relaxed state, the gas vents to atmosphere, allowing the shut-off valve to close.



All standard MC-Series device features and functions are available on the MCV Series and operate in accordance with the standard MC Series operating instructions.

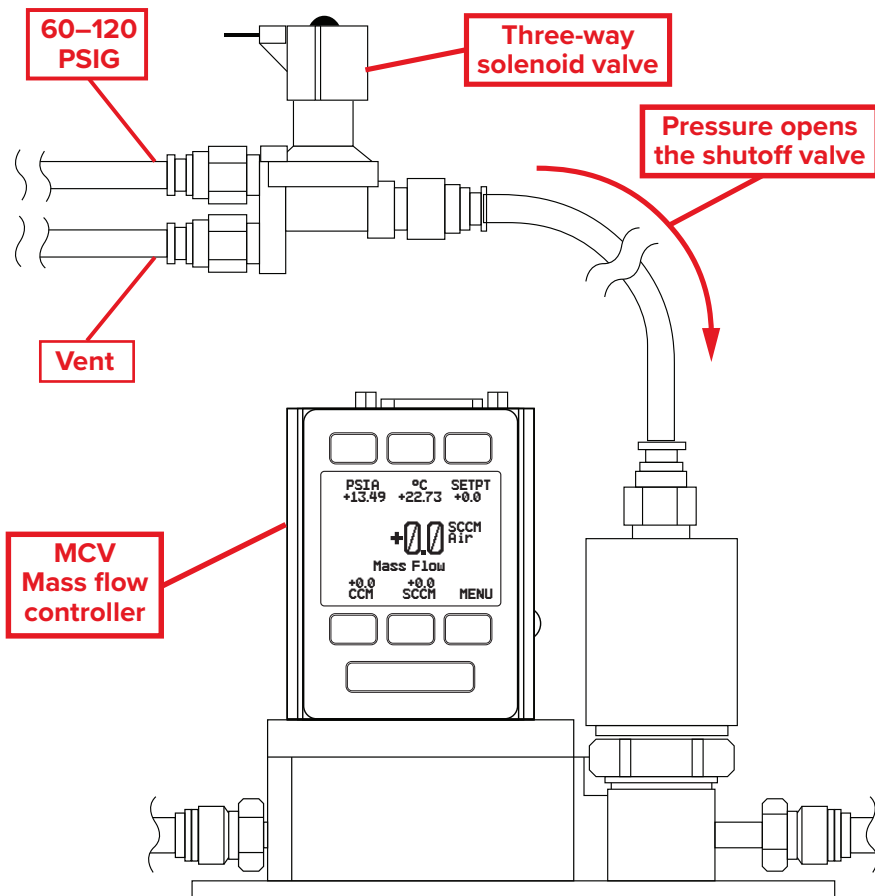

MCD Dual Valve Controller Operating Notes

The MCD is a versatile Dual-Valve Mass Flow and Pressure Controller. It can be used to:

- Measure mass flow and volumetric flow in both directions, plus absolute pressure and temperature.
- Control mass or volumetric flow from a pressurized source or to vacuum.
- Control pressure in a flowing process.
- Control pressure in a closed volume with automatic venting.

Please contact Alicat if you have any questions regarding MCD use.

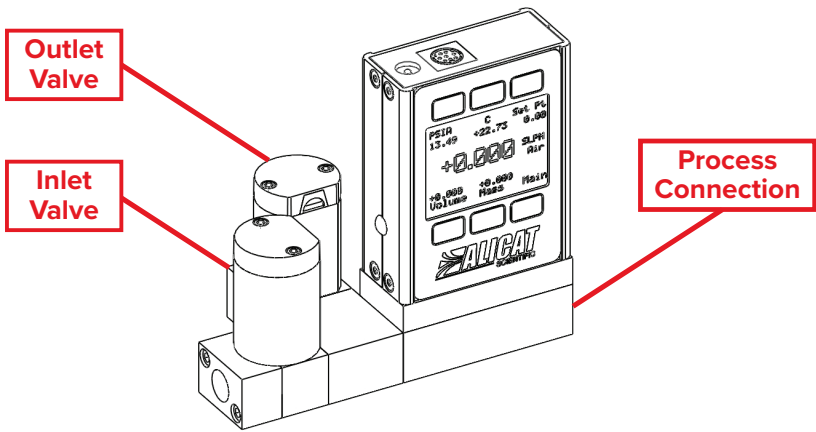

Bidirectional Mass or Volumetric Flow Control

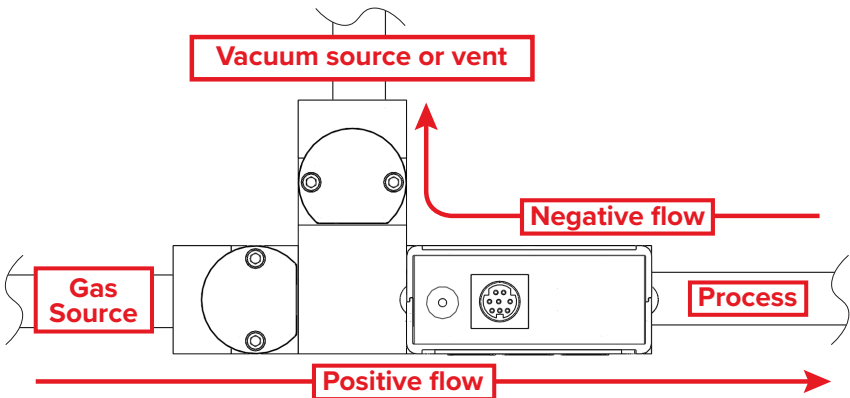

Power and Signal Connections

Power can be supplied to your controller through either the power jack or the multi-pin connector on top of your device.



Small valve controller power jacks require a 12–24 Vdc power supply with a 2.1 mm female positive center plug capable of supplying at least 250 mA. 4–20 mA analog signal outputs require at least 15 Vdc, and 0–10 Vdc outputs require at least 10 Vdc.

Large valve controllers (MCR models) require a 24 Vdc power supply with a 2.1 mm female positive center plug capable of supplying at least 1 A.

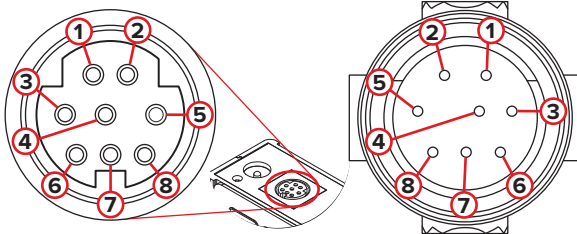

Female Connector: Device

Male Connector: Cable

Standard 8-Pin Mini-DIN Pinout

Pin	Function	Cable color
1	Not Connected (or optional 4–20 mA Primary Output Signal)	Black
2	Static 5.12 Vdc by default. Optional: Secondary Analog Output (4–20 mA, 0–5 Vdc, 1–5V dc, 0–10 Vdc) or Basic Alarm	Brown
3	Serial RS-232 RX / RS-485(-) Input Signal (receive)	Red
4	Analog Setpoint Input	Orange
5	Serial RS-232 TX / RS-485(+) Output Signal (send)	Yellow
6	0–5 Vdc (or optional 1–5 Vdc or 0–10 Vdc) Output Signal	Green
7	Power In (as described above)	Blue
8	Ground (common for power, digital communications, analog signals and alarms)	Purple

Note: The above pinout is applicable to all the flow controllers and controllers with the Mini-DIN connector. The availability of different output signals depends on the options ordered. Optional configurations are noted on the unit's calibration sheet.



Caution: Do not connect power to pins 1 through 6, as permanent damage can occur. It is common to mistake Pin 2 (labeled 5.12 Vdc Output) as the standard 0–5 Vdc analog output signal. Pin 2 is normally a constant 5.12 Vdc that reflects the system bus voltage.

For 6-pin locking industrial connector, M12, DB9, and DB15 pinouts, see [page 56](#) to [page 59](#) or visit alicat.com/pinout.

Analog Signals

Primary Analog Output Signal

Most Alicat instruments include a primary analog output signal, which is linear over its entire range. For both standard 0–5 Vdc and optional 0–10 Vdc output signals, a zero flow condition is usually in the range of 0.010 Vdc. Zero flow for the optional 1–5 Vdc and 4–20 mA output signals is 1 Vdc and 4 mA, respectively. Full scale flow is 5 Vdc for 0–5 Vdc and 1–5 Vdc signals, 10 Vdc for 0–10 Vdc signals and 20 mA for 4–20 mA signals.

Alicat’s default 8-pin mini-DIN connector places the primary analog output on Pin 6 for voltage signals and Pin 1 for 4–20 mA current signals. Ground for these signals is common on Pin 8.

Option: Second Analog Output Signal

Alicat’s default 8-pin mini-DIN connector places the secondary analog output on Pin 2 for both voltage and current signals. Your device’s secondary analog signal may differ from its primary output signal.



See the calibration sheet that shipped with your controller to determine which output signals were ordered.

Option: 4–20 mA Current Output Signal

If your controller has a 4–20 mA current primary or secondary output signal, your flow controller will require 15–30 Vdc power.



Caution: *Do not connect 4–20 mA devices to “loop powered” systems, as this will destroy portions of the circuitry and void the warranty. If you must interface with existing loop powered systems, always use a signal isolator and a separate power supply.*

Option: Color TFT Display

Instruments ordered with a color display function the same as standard backlit monochrome instruments, but color is used to provide additional on-screen information.

Multi-Color Display Indicators

- **GREEN:** Parameter labels and adjustments associated with the button directly above or below the label are presented in green.
- **WHITE:** A parameter is displayed in white while operating under normal conditions.
- **RED:** A parameter is displayed in red when its value exceeds 128% of the device's specifications.
- **YELLOW:** Menu items that are ready to be selected appear in yellow. This color replaces the symbol (>) in selections on monochrome display.



Press the Alicat logo button to turn off the color display backlight. The flow controller remains in operation while the backlight is off.

LCD Contrast

LCD contrast is ranged from 0 to 11 on color displays, with 11 indicating the greatest contrast. See “Display Setup” on **page 39**.

Specifications for Instruments with Color Displays

Color displays will require an additional 40 mA when using a 24 Vdc power supply. All other specifications from your device's specification sheet remain in effect.

Navigation and Customization

Start Here

* Main Display

Flow Controller Menu Map

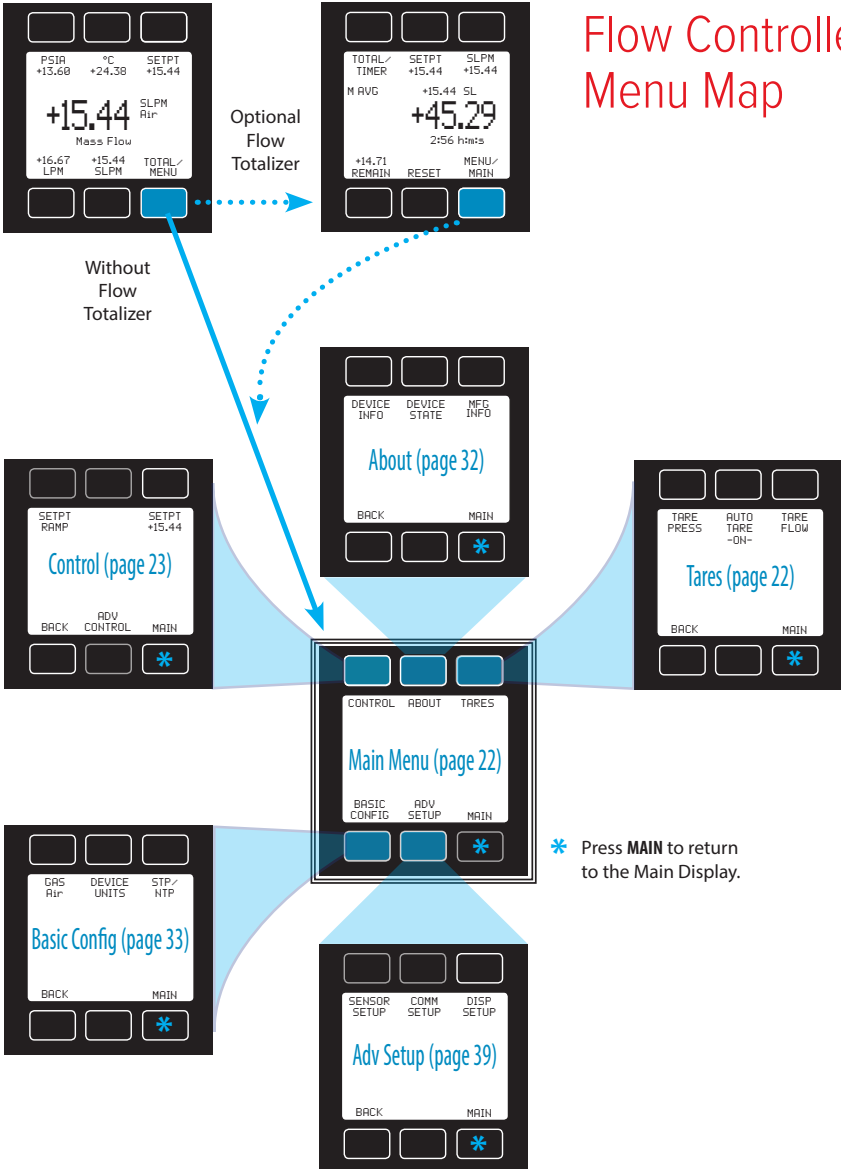

* Press MAIN to return to the Main Display.

Displaying Live Flow Data

The Main Display has three primary functions:

- Displaying live temperature, pressure, and flow data (see below)
- Changing engineering units for temperature, pressure, and flow (**page 18**)
- Changing the flow or pressure control setpoint (**page 24**)

This screen displays live data for all flow parameters simultaneously. Live data is measured 1000 times per second and typically displayed 10 times per second on the device LCD screen. Press the button next to any of the four flow parameters once to highlight its value in the center of the screen. Press the same button again to enter the engineering unit selection menu for that parameter (**page 18**), which can optionally be different from units being displayed (see "Button engineering units" on **page 18**).

Main Display

1 Highlights **pressure** in the center of the meter. Push a second time to select pressure engineering units, or choose the pressure parameter:

- Internal absolute pressure
- Internal gauge pressure (optional)
- Barometric pressure (optional)

2 Highlights **temperature**. Push a second time to select temperature engineering units.

3 SETPT sets the **flow or pressure control setpoint** (see **page 24**).

4 Highlights **volumetric (actual) flow** rate. Push a second time to select volumetric flow rate engineering units.

5 Highlights **mass flow** rate. Push a second time to select mass flow engineering units and switch between standardized, normalized, and true mass flow.

6 TOTAL Accesses **flow totalizer** (optional) (see **page 19**). MENU enters the Menu system (see **page 22**).

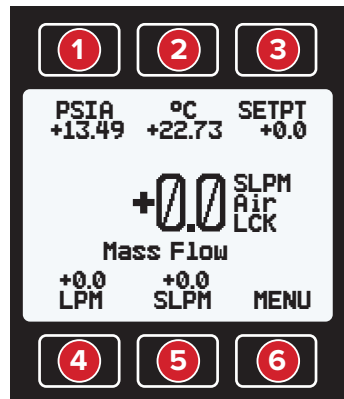

Choosing Engineering Units

Press the button next to any of the four flow parameters twice to enter its unit selection menu. You can change units in two ways:

Button engineering units alter the display only, not the serial data:

- Select **Set button eng units** and press **SELECT** to change the engineering unit on the display only. This does not alter the controller serial data.

Device engineering units alter both the display and the serial data frame:

- Select **Set device eng units** and then choose the **engineering** unit as above. An additional confirmation screen asks you to confirm the serial change.
- If the button engineering unit is different than the device engineering unit, **Set device eng units** will not appear. First select **Show device eng units** to revert the button to the current device unit for that parameter. Enter the unit selection menu again to change the device engineering unit.

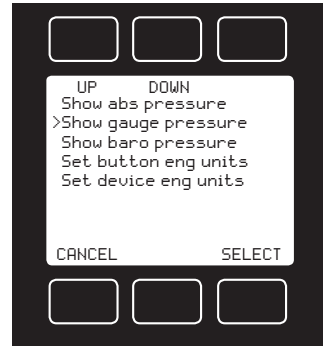

The example above shows the unit selection menu for a device that has the internal barometer option.

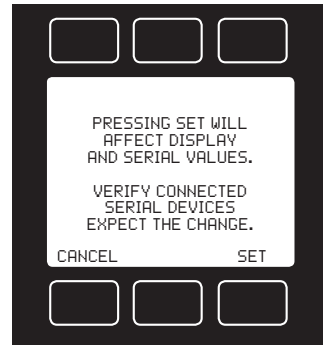

Examples of changing device engineering units:

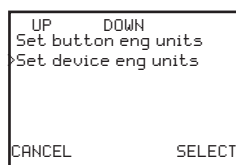
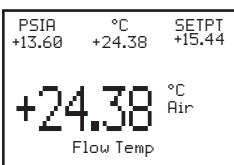
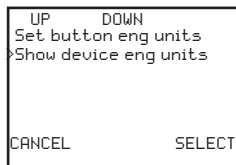
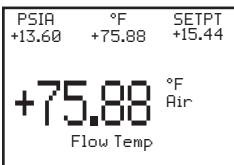

Changing device units:

In the example on the left, °F is not the existing device engineering unit, so the unit selection menu displays **Show device eng units**. Select this to revert the button unit to the device engineering unit for this parameter.

Changing device units:

After the change, °C is the existing device engineering unit, so the unit selection menu displays **Set device eng units**. Select this to choose a new unit.

Option: Totalized Flow Data and Batch Dispensing

Your flow controller may have an optional flow totalizer, which enables batch dispensing. The totalizer displays the total amount of mass or volume that has flowed through the instrument since its last reset, like a gasoline pump. Access the totalizer screen by pressing **TOTAL/MENU** on the Main Display.

Totalizer – Main Screen Totalizer Rollover Functions

TOTAL/TIMER Toggles between totalized flow and elapsed time as the parameter highlighted in the center.

SETPT Displays the current setpoint. Press to set a new setpoint or to clear the setpoint.

Displays live flow rate. Press to select engineering units.

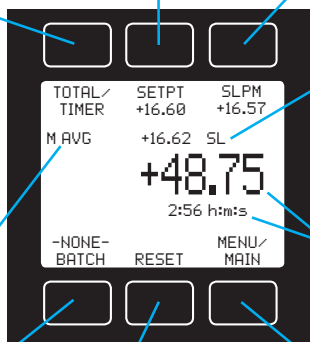
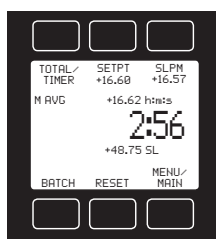

Alternating display of:

- Selected engineering unit for totalized flow or time (page 33).
- Selected gas calibration (page 34).

M AVG or **V AVG** Optional totalizer averaging: Displays average flow rate since last reset, updated live.

Displays totalized flow and elapsed time since last reset. These units alternate with status messages when any are present (page 8).

BATCH Selects the quantity to be dispensed in each batch. Displays **-NONE-** when no batch volume is configured.

RESET Clears all totalized data and resets the timer to 0. The next batch, if set, begins immediately.

MENU/MAIN Enters the Menu system (page 17). From there, press **MAIN** to exit to the Main Display of live data.

Your flow totalizer has been configured to report a maximum of 7 digits. By default, the placement of the decimal is the same as the live flow rate. The totalizer can be configured at the time of order for the following behaviors. (By default, the totalizer rolls over and displays **OVR**.)

- **Rollover:** Totalizer resumes counting from 0 as soon as the maximum count has been reached.
- **Freeze:** Totalizer stops counting at max count, until it is reset manually.
- **Error:** Displays **OVR** status message when maximum count has been reached; compatible with Rollover and Freeze.

The elapsed time counter has a maximum value of 9999:59:59 (h:m:s) (416 days, 16 hours). If flow is still being totalized at that point, the timer freezes, regardless of the behavior chosen above for the totalized flow readings.

Dispensing Gas in Batches

Batch dispensing allows you to choose a desired total volume to flow, after which the valve closes. You can repeat batches with a single button press.

Totalizer – Batch Mode

SETPT Displays the current setpoint. Batch dispensing can begin only when there is a non-zero setpoint.

Flow stops as soon as the batch completes.

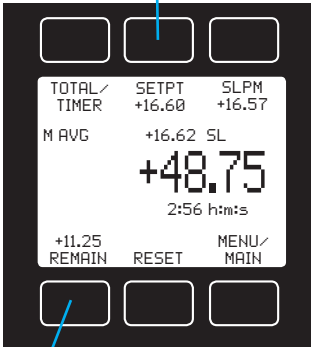

REMAIN Displays the remaining quantity yet to be dispensed. Press to select a new quantity.

DONE BATCH Appears when the batch is complete. Press to select a new quantity to be dispensed.

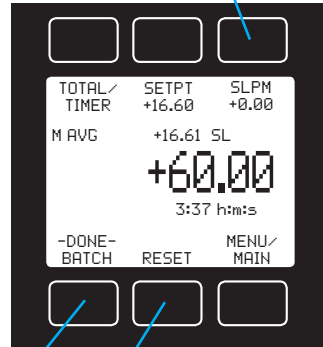

RESET Clears all totalized data and resets the timer to 0. The next batch begins immediately.

How to start batch dispensing

1. From the totalizer screen, press **BATCH**. Choose the total quantity to be dispensed in each batch. Press **SET** to accept the new batch size.
2. From the totalizer screen, press **SETPT** to choose a non-zero setpoint. Flow begins as soon as you press **SET**.



Note: Batch dispensing requires an active batch size and a non-zero setpoint. If your controller already has a non-zero setpoint, flow begins as soon as you press **SET** from the batch size screen.

3. While a new batch is being dispensed, the **BATCH** button changes to show the quantity that remains to be dispensed. When the batch size has been achieved, the **BATCH** button displays **-DONE-** and flow stops automatically.

The batch size can be changed while a batch is in progress. If the new batch size is larger than the current totalized flow, then flow continues until the new value is reached. If the new batch size is smaller than the current totalized flow, then the flow stops immediately. Press **RESET** to start the new batch.

How to repeat a batch

- For a new batch of identical size, simply press **RESET**. Flow begins immediately.
- For a new batch of a different size, press **BATCH**, and then select the new batch size. Flow begins as soon as you press **SET**.

How to cancel a batch

1. To pause a batch in progress, set the mass flow setpoint to 0 by pressing **SETPT** → **CLEAR** → **SET**. Resume with a non-zero set point.
2. To remove a batch setting, press **TOTAL/MENU** → **BATCH** → **CLEAR** → **SET** and then select a batch size of 0. Deleting the batch has no effect on the flow setpoint, so unless the controller's flow is interrupted (as in step 1 above) the controller will continue to allow flow at the setpoint's rate.



Caution: *If your controller has a non-zero setpoint when batch dispensing is turned off, flow will resume immediately at the current setpoint.*



Note: *The batch size is retained across power cycles of your flow controller. It must be manually cleared when no longer desired.*

When batch mode is off, **-NONE-** appears above the **BATCH** button.

Using the Totalizer or Batch Dispensing while Controlling Pressure

While using a mass flow controller in pressure control mode, it is possible for the flow rate to exceed the maximum measurable flow (128% of full scale) when making an abrupt pressure change. In this case, the totalized flow value will flash, and the controller will report a **TMF** message to indicate that the totalizer missed flow data. Please reset the totalizer to clear the incomplete data.



Caution: *In certain situations, it is possible to exceed the desired batch size. For example, if the feed pressure is too low to achieve the flow setpoint and then pressure is suddenly increased, the batch size may be exceeded before the valve reacts to the sudden burst of pressure.*

Menu

Enter the menu system by pressing the **MENU** button from the Main Display.

ABOUT Enters the About Menu (page 32).

TARES Enter the Tares Menu (page 22)

CONTROL Enters the Control Menu (page 23).

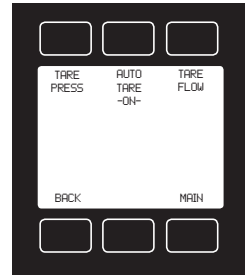
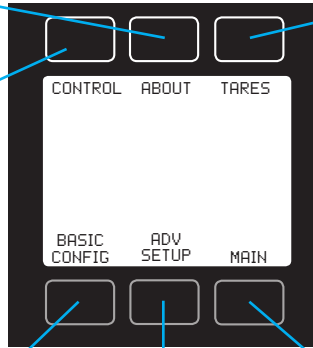

BASIC CONFIG Enters the Basic Configuration Menu (page 33).

ADV SETUP Enters the Advanced Setup Menu (page 39).

MAIN Exits to the Main Display (page 17).

Taring Your Flow Controller

Taring is an important practice that ensures that your flow controller is providing the most accurate measurements possible. This function gives the flow controller a good zero reference for flow measurements. For controllers with a barometer, taring can also be used to align the internal absolute pressure sensor with the barometric pressure reading.

How to Tare

When auto tare is **-ON-** your flow controller automatically tares its flow rate whenever it has a zero setpoint for more than two seconds. For manual tares, follow these steps:

1. Ensure that nothing is flowing through the device, usually by giving the controller a zero setpoint.
2. **MENU** → **TARES** → **TARE FLOW**. Flow tares should occur at the expected process pressure, as long as there is no flow.
3. **MENU** → **TARES** → **TARE PRESS**. Absolute pressure tares must be done with the controller open to atmosphere. (Optional barometer required.)

When to tare

- After significant changes in temperature or pressure.
- After installing the controller in a different orientation.
- After dropping or bumping the flow controller.

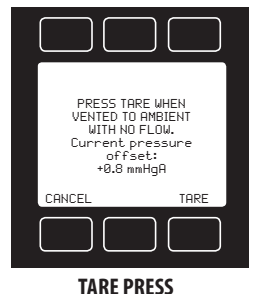
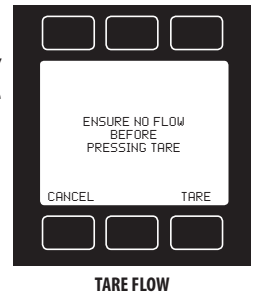

Control Menus

The **CONTROL** and **ADV CONTROL** menus allow you to command new setpoints, change the setpoint control loop, and adjust proportional integral and derivative (PID) control settings, among other options.

Menu → Control

SETPT RAMP Activates and sets the speed of setpoint ramping (page 26).

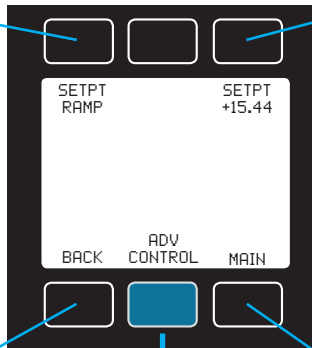

SETPT Displays the current setpoint. Press to command a new setpoint or clear the existing one.

Setpoints are not editable via the display if the setpoint source is **Analog**.

BACK Returns to the top-level Menu (page 17).

MAIN Exits to the Main Display (page 17).

Menu → Control → Advanced Control

SETPT SOURCE Toggles the setpoint input between serial and analog sources.

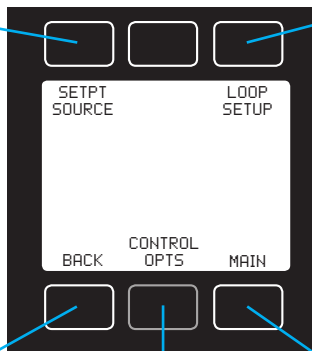

LOOP SETUP Selects the type of closed loop control and adjusts PID settings (page 29).

BACK Returns to the Control Menu (above).

CONTROL OPTS Sets options for setpoint ramping, setpoint limits and flow limiting for pressure control (page 25–page 28).

MAIN Exits to the Main Display (page 17).

Changing the Setpoint

Press the **SETPT** button from either the Main Display or the Control Menu (**MENU CONTROL**) to choose a new setpoint. The setpoint selection screen indicates the engineering units and maximum allowable setpoint (e.g., **SLPM 20.00 Max**). To cancel a setpoint, press **CLEAR**.

Changing Between Setpoint Sources

Mass flow controllers with RS-232/RS-485 and/or Modbus RTU communication will accept setpoints from the front panel, a serial connection, or an analog signal. Change the setpoint source by selecting **MENU → CONTROL → ADV CONTROL → SETPT SOURCE**.

- When the source is set to **Serial/Front Panel**, the controller will accept input from either the front panel, or an RS-232/RS-485 connection. Neither source is a slave of the other, so the controller will accept the most recent command from either source.
- When the source is set to **Analog**, the controller will ignore serial setpoint commands and will prevent input from the front panel.

Adjusting the setpoint with the optional IPC (Integrated Potentiometer Control)

If your controller has been ordered with a potentiometer control knob (IPC), the setpoint source must be set to Analog for the controller to accept setpoint commands from the IPC.



When using an analog setpoint signal with a controller that has an IPC, leave the IPC knob at the midpoint when it is not in use.

Changing the Control Loop Variable

Your mass flow controller can control the flow rate or the pressure in your process. Change the control loop variable by selecting **MENU → CONTROL → ADV CONTROL → LOOP SETUP → LOOP VAR**. Loop variables include mass flow, volumetric flow, and absolute pressure. Devices with internal barometers also allow control of gauge pressure.



Note: *When pressure is selected as the control loop variable, flow controllers with upstream valves will control the outlet pressure. Those with downstream valves can control upstream back-pressure, but these must be configured for this type of control.*



*When changing the control loop from mass or volumetric flow to absolute or gauge pressure, you may need to adjust the PID settings for optimal stability and speed of response. (See PID on **page 29**.)*

Establishing Setpoint Limits

The Setpoint Limits Menu lets you set up upper and lower limits for selecting a flow or pressure control setpoint. To access this menu, select **MENU → CONTROL → ADV CONTROL → CONTROL OPTS → SETPT LIMITS**.

- When using the front panel, if you try to command a new setpoint that is outside of the upper and lower limits, the display notifies you that the requested setpoint is out of range.
- Over a serial connection, a setpoint outside the limit will be rejected with an error. When using an analog setpoint signal, setpoints that are outside of the setpoint limits are treated as if they were at the nearest limit. If you request a setpoint that is below the lower limit, the controller makes the setpoint to be at the lower limit. Likewise, if you request a setpoint that is above the upper limit, the controller sets the setpoint at the upper limit.



Flow controllers that have non-zero lower setpoint limits cannot be set to stop flow until the lower limit has been cleared.



Note: *When changing from one control loop variable to another, the flow controller remembers setpoint limits as percentages of full scale. For example, a 10-SLPM limit on a unidirectional 20-SLPM controller (50% full scale) will become a limit of 80 PSIA (50% of 160 PSIA) if the control loop is changed to absolute pressure.*

Menu → Control → Advanced Control → Control Options → **Setpoint Limits**

REMOVE LIMITS Clears the minimum and maximum setpoint limits.

USER MIN Sets the lower (minimum) setpoint limit.

USER MAX Sets the upper (maximum) setpoint limit.

BACK Returns to the Control Options Menu (page 31).

MAIN Exits to the Main Display (page 17).

USER MIN	REMOVE LIMITS	USER MAX
-None-		10.000
BACK		MAIN

Using Setpoint Ramping

Setpoint ramping regulates how quickly your mass flow controller will reach the requested flow or pressure setpoint. This feature is especially useful when you need to prevent sudden bursts of pressure or flow from hitting delicate instruments when you start up your process.

To activate setpoint ramping, you need to set a maximum ramp rate, and you need to configure when to enable the ramping function.

Setting a Maximum Setpoint Ramp Rate

With ramping enabled in at least one direction, set up the maximum ramp rate by selecting **MENU** → **CONTROL** → **SETPT RAMP**. Press **DELTA** to define the maximum allowable change in flow rate or pressure. Press **TIME** to define the amount of time within which that change occurs. The flow controller will display the resulting maximum ramp rate in the center of the display.



Note: *Setpoint ramping can be used with flow or pressure setpoints, depending on the control loop selected. Ramping for pressure control limits how quickly pressure changes before reaching the setpoint. To limit flow rates directly while controlling pressure, see “Limiting flow rate while controlling pressure” on page 28.*

Menu → Control → Setpoint Ramp

The diagram shows a control panel interface for the Setpoint Ramp menu. The screen displays the following information:

DELTA	TIME	TIME
5.000	UNITS	10.000
SLPM		s

Current Max Ramp Rate
0.49999999
SLPM / s

BACK MAIN

Callouts from the diagram:

- DELTA** Sets the change in flow rate or pressure that will be allowed in the time interval.
- TIME UNITS** Selects the unit of time to be used in calculating the ramp rate.
- TIME** Sets the time interval over which the flow or pressure can change by the given DELTA.
- BACK** Returns to the Control Menu (page 23).
- MAIN** Exits to the Main Display (page 17).

Enabling the Setpoint Ramping Function

Your flow controller enables the ramping function independently for changes that require increases or decreases to achieve the new setpoint. For example, you can enable ramping up to a flow setpoint to prevent flow from building too quickly, but disable ramping down so that you can stop flow immediately. Enable these ramping directions by selecting **MENU** → **CONTROL** → **ADV CONTROL** → **CONTROL OPTS** → **RAMP ENABLE**. Each direction toggles on and off.

Menu → Control → Advanced Control → Control Options → **Ramp Enable**

RAMP UP Toggles ramping up to the flow or pressure setpoint

RAMP DOWN Toggles ramping down to the flow or pressure setpoint

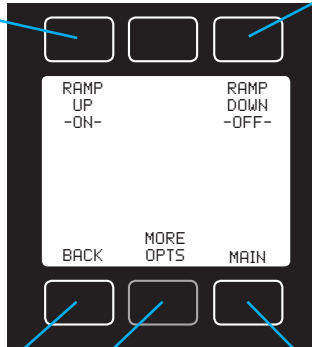

BACK Returns to the Control Options Menu (page 31).

MORE OPTS Enables overrides for power on and 0 setpoint scenarios.

MAIN Exits to the Main Display (page 17).

Enabling setpoint ramping overrides

The **MORE OPTS** button in the Ramp Enable Menu lets you set up overrides for the ramping function for two independent scenarios:

- **POWER ON** applies an override where the controller ignores any enabled ramping whenever it is powered on. If it had a non-zero setpoint when it was turned off, it immediately reapplies this former setpoint. All setpoints after power up honor the enabled ramping options. This override is indicated by “Setpt at power on is instantly applied”.
- **ZERO CMD** applies an override where controller ignores any enabled ramping whenever a 0 setpoint has been commanded. This override is indicated by “Zero setpt command instantly zeroes”.



Note: The two ramping options above either honor or override the ramp settings established in the Ramp Enable Menu. If ramping is not enabled for either direction, the override options have no effect.

Limiting Flow Rate While Controlling Pressure

When the control loop variable is set to control pressure, setpoint ramping regulates how quickly it reaches the pressure setpoint by limiting how quickly the measured pressure can change. This provides direct control of pressure.

To limit flow rates directly while controlling pressure, set up flow limiting for pressure control by selecting **MENU → CONTROL → ADV CONTROL → CONTROL OPTS → CLP MAX FLOW**. Press **FLOW TYPE** to select a flow control loop based on mass flow or volumetric flow. Press **CLP MAX FLOW** to set the desired maximum flow rate.

The **LIMIT GAIN** option determines how aggressively the proportional control function will correct the error when the flow rate exceeds the defined maximum flow setting. Be sure to record the initial value before attempting any changes to this variable.



Note: *If both flow limiting and pressure setpoint ramping are active when controlling pressure, the more restrictive function will regulate the controller's operation as it attempts to attain the setpoint.*

Menu → Control → Advanced Control → Control Options → **CLP Max Flow**

CLP MAX FLOW Sets the maximum flow rate limit during pressure control.

FLOW TYPE Sets the controller to limit flow based on a Mass or Volumetric reference.

LIMIT GAIN Adjusts the gain of the proportional control function for flow limiting. Contact Alicat about adjusting this.

CLP MAX FLOW	FLOW TYPE	LIMIT GAIN
2.000		1000

BACK MAIN

BACK Returns to the Advanced Control Menu (page 23).

MAIN Exits to the Main Display (page 17).

Adjusting the Closed Loop Controller

Your mass flow controller uses an electronic closed loop controller to determine how to actuate its valve(s) in order to achieve the commanded setpoint. We have tuned these settings for your specific operating conditions, but changes to your process sometimes require on-site adjustments to maintain optimal control performance. If you encounter issues with control stability, oscillation or speed of response, fine-tuning your closed loop control may help.

The **LOOP SETUP** menu (**MENU** → **CONTROL** → **ADV CONTROL** → **LOOP SETUP**) lets you choose the closed loop control algorithm and adjust the gain settings for the proportional, integral, and derivative variables.

Tuning the PD/PDF control algorithm

Alicat's default control algorithm (PD) employs pseudo-derivative feedback (PDF) control, which uses two editable variables:

- The larger the **D** gain, the slower the controller will correct errors between the commanded setpoint and the measured process value. This is equivalent to the P variable in common PDF controllers.
- The larger the **P** gain, the faster the controller will correct for offsets based on the size of the errors and the amount of time they have occurred. This is equivalent to the I variable in common PDF controllers.



Note: The D and P variables in Alicat's PD/PDF control algorithm are more typically referred to as P and I, respectively, in PDF controllers.

Menu → Control → Advanced Control → Loop Setup

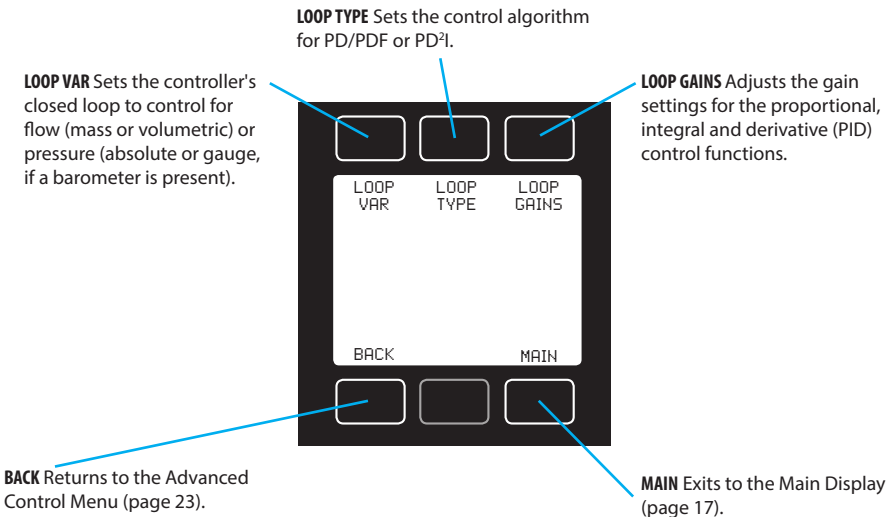

Tuning the PD²I control algorithm

Alicat's PD²I control algorithm (also called PDDI) is used to provide faster response, most commonly in dual-valve flow and pressure controllers. This algorithm uses typical PI terms and adds a squared derivative term (D):

- The larger the **P** gain, the more aggressively the controller will correct errors between the commanded setpoint and the measured process value.
- The larger the **I** gain, the faster the controller will correct for offsets based on the size of the errors and the amount of time they have occurred.
- The larger the **D** gain, the faster the controller will predict needed future corrections based on the current rate of change in the system. This often results in slowing the system down to minimize overshoot and oscillations.

Troubleshooting valve performance with PID tuning

The following issues can often be resolved by adjusting the PID gain values for your mass flow controller.

Fast oscillation around the setpoint

- PD: Reduce the P gain in decrements of 10%
- PD²I: Increase the P gain in increments of 10%, and then adjust the I gain to fine-tune.

Overshot setpoint

- PD: Reduce the P gain in decrements of 10%.
- PD²I: If D is not 0, increase the P gain in increments of 10%.

Delayed or unattained setpoint

- PD: Increase the P gain in increments of 10%, and then decrease the D gain by small amounts to fine-tune.
- PD²I: Increase the P gain in increments of 10%, and then increase the I gain to fine-tune.



For help with configuring PD²I for the first time, visit alicat.com/pd2i for tuning instructions.



Valve tuning can be complex. Please give us a call, and we'll be happy to guide you through the process. Or, visit alicat.com/pid for more detailed instructions.

Using a Control Deadband for MCDs

The control deadband is designed for use with closed-volume pressure control applications to minimize the amount of gas exhausted. The deadband defines a region above and below the setpoint within which the process variable is permitted to deviate from the setpoint.

Example: When controlling pressure in a closed volume with a setpoint of 30 PSIA, a deadband of ± 1 PSIA would allow the absolute pressure to vary between 29 and 31 PSIA before actively controlling the valves to the setpoint.

To turn on the control deadband, enter a non-zero value in **MENU** → **CONTROL** → **ADV CONTROL** → **CONTROL OPTS** → **DEAD BAND**. In order for the deadband to activate, the setpoint must first be achieved by the controller. If the process variable drifts to a deadband limit, active control resumes until the setpoint is achieved again.



Note: Deadband settings for a **pressure control loop** close the valve(s) when activated.

Deadband settings for a **flow control loop** freeze the valve(s) in its current position.



CAUTION: Control deadband is also available on single valve mass flow controllers, however they do not have an exhaust valve to reduce pressure when pressure exceeds the deadband.

Menu → Control → Advanced Control → Control Options

DEAD BAND Sets the size of the control deadband.

RAMP ENABLE Defines the conditions when setpoint ramping will be active (page 26).

CLP MAX FLOW Limits flow rate when controlling pressure (page 28).

BACK Returns to the Advanced Control Menu (page 23).

SETPT LIMITS Sets upper and lower setpoint limits (page 25).

MAIN Exits to the Main Display (page 17).

RAMP ENABLE	DEAD BAND 0.050	CLP MAX FLOW
BACK	SETPT LIMITS	MAIN

About

We hope you don't run into trouble using your flow controller, but if you do, the **ABOUT** menu contains information that can make the troubleshooting process easier. Select **MFG INFO** to look up Alicat's phone number and web address. **DEVICE INFO** shows you the serial number and firmware version (**SW:**) for your specific device. It also gives you the original manufacturing date and the last calibration date, as well as the initials of the Alicat calibration technician.

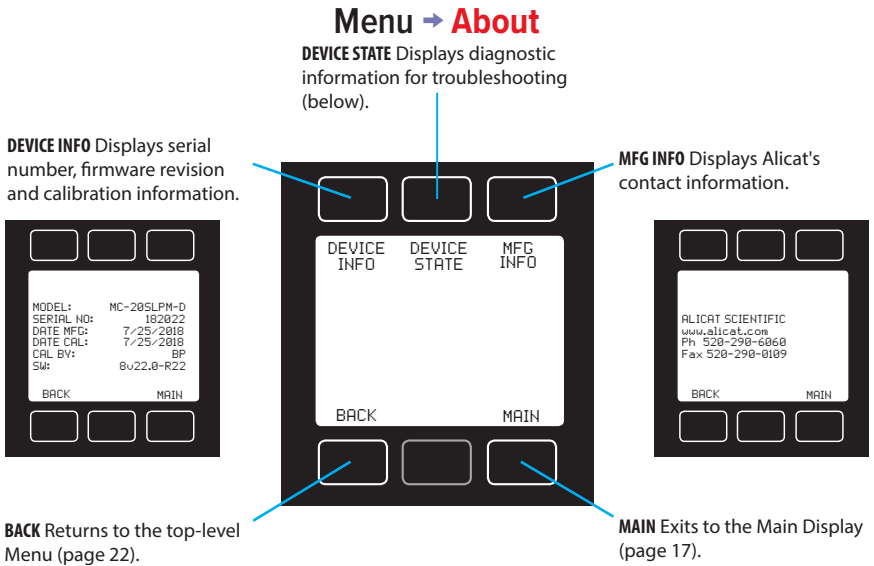

Diagnostic Information

The **DEVICE STATE** screen displays live values for the internal device registers.

Many of these values can help an Alicat applications engineer diagnose operational issues over the phone. Some register values clearly distinguish between hardware and operational problems, which speeds up the troubleshooting process.

Within the **DEVICE STATE** screen (**MENU → ABOUT → DEVICE STATE**), press **PAGE** to advance to the next page of register values.

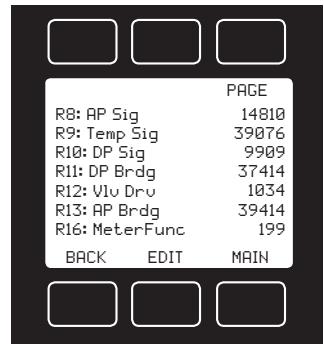

Basic Configuration Menu

The Basic Configuration Menu contains options for choosing the gas calibration, device engineering units and STP/NTP mass flow references.

Menu → Basic Configuration

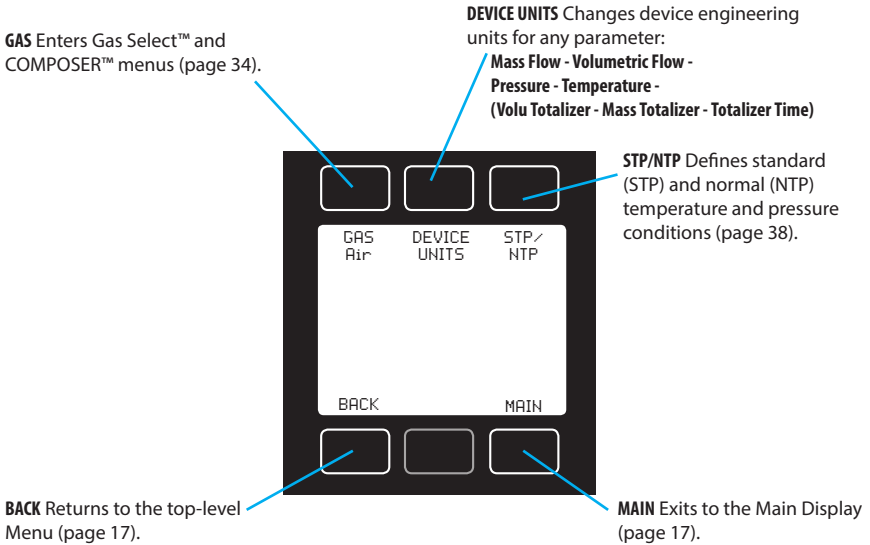

Choosing Engineering Units from the Basic Configuration

Your flow controller will come with preselected engineering units based on the full scale range of your device, usually SLPM or SCCM. Changing device engineering units alters both the display and the data frame. First choose the parameter whose unit you want to change, and then select your desired engineering unit, confirming the change on the last screen. If your controller has been configured with a flow totalizer, this screen will also include units for totalized volumetric and mass flow, plus elapsed time.

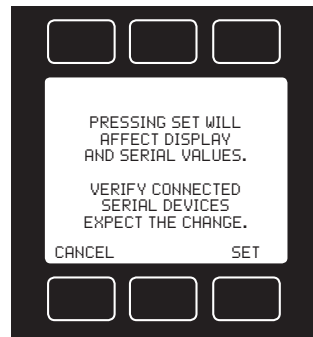
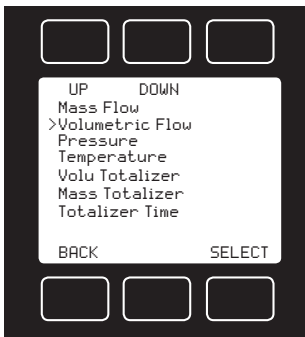

Gas Select™

In most cases, your flow controller was physically calibrated on air at Alicat's factory. Gas Select™ allows you to reconfigure the flow controller to flow a different gas without sending it back to Alicat for a physical recalibration.

To use Gas Select™, simply choose a gas or gas mix from one of the listed categories. As soon as you press **SELECT** from the gas listing, your flow controller will reconfigure itself to accurately measure the flow of your chosen gas. There is no need to restart the flow controller.

Your current gas selection appears just below the unit's indicator on the right side of the Main Display:

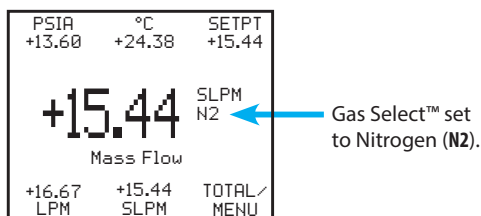

Menu → Basic Config → Gas → Category Listing

UP/DOWN Moves the selection arrow up or down the listing of gas categories.

PAGE Advances the view to the next page of categories.

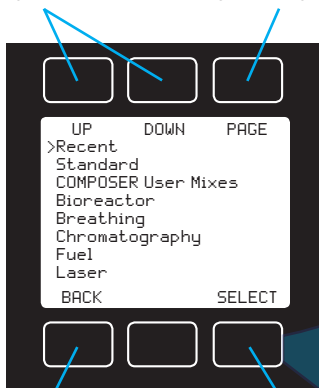

BACK Returns to the Basic Configuration Menu (page 22).

SELECT Opens the category to view its gases.

UP/DOWN Moves the selection arrow up or down the listing of gases.

PAGE Advances the view to the next page of gases.

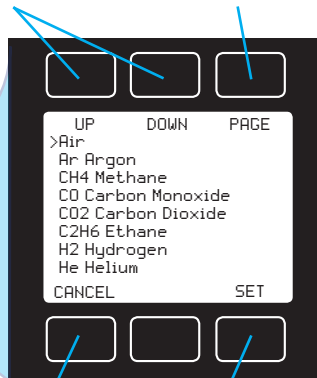

CANCEL Returns to the listing of gas categories.

SET Loads the gas properties data for the selected gas and exits to the Main Display (page 17).

Gas List

Your Alicat is preloaded with gas properties data for the following gases:

Pure Non-Corrosive Gases

Acetylene (C₂H₂)
Air (Clean Dry)
Argon (Ar)
Isobutane (i-C₄H₁₀)
Normal Butane (n-C₄H₁₀)
Carbon dioxide (CO₂)
Carbon monoxide (CO)
Deuterium (D₂)
Ethane (C₂H₆)
Ethylene (Ethene) (C₂H₄)
Helium (He)
Hydrogen (H₂)
Krypton (Kr)
Methane (CH₄)
Neon (Ne)
Nitrogen (N₂)
Nitrous Oxide (N₂O)
Oxygen (O₂)
Propane (C₃H₈)
Sulfur Hexafluoride (SF₆)¹
Xenon (Xe)

Breathing Gases

Metabolic Exhalant
EAN-32 EA-80 Heliox-50
EAN-36 Heliox-20 Heliox-60
EAN-40 Heliox-21 Heliox-80
EA-40 Heliox-30 Heliox-80
EA-60 Heliox-40 Heliox-99

Bioreactor Gas Mixes

5%–95% CH₄/CO₂ in 5% increments

Refrigerants²

R-11 ³	R-116	R-152a
R-14	R-124 ³	R-318
R-22 ³	R-125 ³	R-404A ³
R-23 ³	R-134a ³	R-407C ³
R-32 ³	R-142b ³	R-410A ³
R-115 ³	R-143a ³	R-507A ³

Welding Gases

C-2	C-25	He-75
C-8	C-50	He-90
C-10	C-75	
C-15	He-25	A 1025
C-20	He-50	Stargon CS

Chromatography Gas Mixes

P-5	P-10
-----	------

Oxygen Concentrator Gas Mixes

89% O₂, 7% N₂, 4% Ar
93% O₂, 3% N₂, 4% Ar
95% O₂, 1% N₂, 4% Ar

Stack/Flue Gas Mixes

2.5% O₂, 10.8% CO₂, 85.7% N₂, 1% Ar
2.9% O₂, 14% CO₂, 82.1% N₂, 1% Ar
3.7% O₂, 15% CO₂, 80.3% N₂, 1% Ar
7% O₂, 12% CO₂, 80% N₂, 1% Ar
10% O₂, 9.5% CO₂, 79.5% N₂, 1% Ar
13% O₂, 7% CO₂, 79% N₂, 1% Ar

Laser Gas Mixes

4.5% CO₂, 13.5% N₂, 82% He
6% CO₂, 14% N₂, 80% He
7% CO₂, 14% N₂, 79% He
9% CO₂, 15% N₂, 76% He
9.4% CO₂, 19.25% N₂, 71.35% He
9% Ne, 91% He

Fuel Gas Mixes

Coal Gas 50% H₂, 35% CH₄, 10% CO, 5% C₂H₄
Endothermic Gas 75% H₂, 25% N₂
HHO 66.67% H₂, 33.33% O₂
LPG HD-5 96.1% C₃H₈, 1.5% C₂H₆, 0.4% C₃H₆, 1.9% n-C₄H₁₀
LPG HD-10 85% C₃H₈, 10% C₃H₆, 5% n-C₄H₁₀

Natural Gases

93% CH₄, 3% C₂H₆, 1% C₃H₈, 2% N₂, 1% CO₂
95% CH₄, 3% C₂H₆, 1% N₂, 1% CO₂
95.2% CH₄, 2.5% C₂H₆, 0.2% C₃H₈, 0.1% C₄H₁₀, 1.3% N₂, 0.7% CO₂

Synthesis Gases

40% H₂, 29% CO, 20% CO₂, 11% CH₄
64% H₂, 28% CO, 1% CO₂, 7% CH₄
70% H₂, 4% CO, 25% CO₂, 1% CH₄
83% H₂, 14% CO, 3% CH₄

Pure Corrosive Gases²

Ammonia (NH ₃)	Dimethylether (DME)
Butylene (1-Buten)	Hydrogen Sulfide (H ₂ S)
Cis-Butene (c-Buten)	Nitrogen Trifluoride (NF ₃)
Isobutane (i-Buten)	Nitric Oxide (NO)
Trans-Butene (t-Buten)	Propylene (C ₃ H ₆)
Carbonyl Sulfide (COS)	Silane (SiH ₄)
Chlorine (Cl ₂) ⁴	Sulfur Dioxide (SO ₂) ⁴

¹ Sulfur hexafluoride is a highly potent greenhouse gas monitored under the Kyoto Protocol.

² S-series units only

³ Under the Montreal Protocol and Kigali Amendment, the production and consumption of these ozone-depleting substances (ODS) is being or has been phased out. It is recommended you ensure compliance with this universally ratified treaty before attempting to use these gases, in addition to R113, R-123, and R-141b.

⁴ S-series with PCA valves only

Using COMPOSER™ to Create Custom Gas Mix Compositions

To remain accurate, your flow controller needs to know the viscosity of the gas you are flowing through it. The more closely you can define your actual gas composition, the more accurate your flow readings will be. Alicat's COMPOSER™ is an included feature of Gas Select™ that lets you define new mixed gas compositions to reconfigure your flow controller on the fly.

COMPOSER™ uses the Wilke method to define a new gas mixture based on the molar (volumetric) ratios of the gases in the mixture. You can define these gas compositions to 0.01% for each of up to five constituent gases in the mixture. Once you define and save a new COMPOSER™ gas mix, it becomes part of the Gas Select™ system and is accessible under the gas category COMPOSER™ User Mixes. You can store 20 COMPOSER™ gas mixes on your flow controller.



Note: COMPOSER™ does not physically mix any gases, it configures your flow controller to report flow readings accurately based on the constituent gases of your mixture. If you require turnkey gas mixing, please contact Alicat.

Menu → Basic Config → Gas → COMPOSER User Mixes

To access COMPOSER™, select **COMPOSER User Mixes** from the Gas Select™ category listing. Select any existing mix to reconfigure your flow controller to flow that gas mixture. Select **Delete Mix** to permanently remove a gas mix.

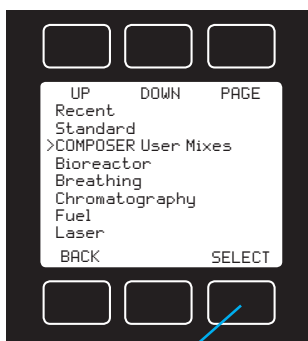

SELECT Enters the COMPOSER™ Menu.

To access COMPOSER™, select **COMPOSER™ User Mixes** from the Gas Select™ category listing. Select any existing mix to reconfigure your flow controller to flow that gas mixture. Select **Delete Mix** to permanently remove a gas mix.

Add Mix Creates a new COMPOSER™ gas mix.

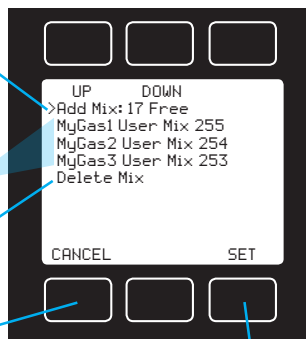

COMPOSER™ Mixes Selects an existing gas mix to use.

Delete Mix Deletes an existing gas mix. (Option appears if at least 1 mix exists.)

CANCEL Returns to the Gas Select™ Menu (page 34).

SET Confirms your selection and exits to the Main Display (page 17).



Note: Your Alicat device does not store the composition of saved gas mixes, only the required viscosity and density as a function of temperature and pressure. It might be helpful to write it down.

Adding a new COMPOSER™ mixed gas composition

Generate and store a new COMPOSER™ mix in 3 easy steps.



Note: You cannot save your mix until the total is 100%.

Saved gas compositions can be deleted, but not modified.

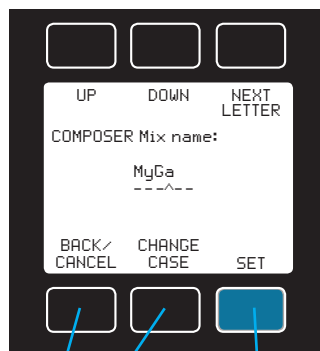

1 Name the mix.

CHANGE CASE
Toggles upper/lower case.

SET Accepts the name.

BACK/CANCEL Exits to the COMPOSER™ Menu.

CREATE NEW/SIMILAR Restarts at Step 1. After saving a name, **CREATE SIMILAR** duplicates the mix you just saved. *Note: CREATE SIMILAR is not accessible after leaving this screen.*

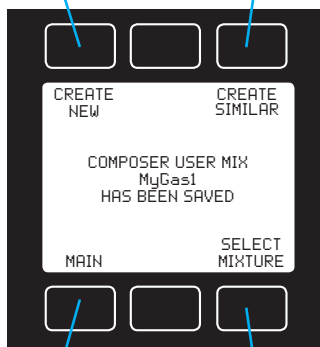

3 Save the mix.

MAIN Exits to the Main Display and keeps your existing gas selection. **SELECT MIXTURE** also activates the new COMPOSER™ mix.

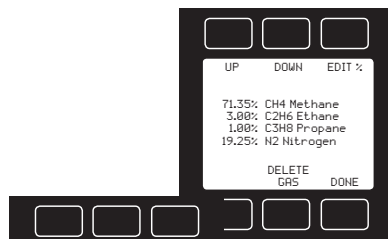

GAS OPTNS Edits the non-final gas mix composition. You can delete a gas or change its composition percentage.

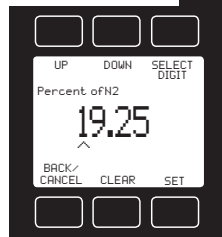

ADD GAS Enters GAS SELECT™ listing to choose a gas, then asks you to set its composition percentage.

EDIT NAME Returns to Step 1.

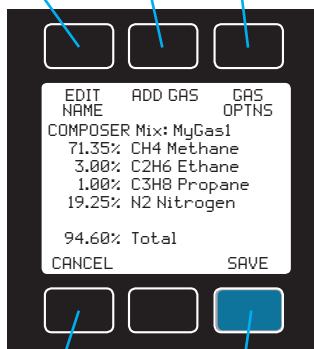

2 Define the mix.

CANCEL Exits to the COMPOSER™ Menu.

SAVE Adds the new mix to COMPOSER™.

Defining STP/NTP Reference Values

Standardized flow rates are reported in “standard” or “normal” volumetric flow units that reference a given temperature and pressure combination. This reference is called an STP (standard temperature and pressure) or, typically in Europe, an NTP (normal temperature and pressure).

Menu → Basic Config → **STP/NTP**

Stan T: Standard Temperature
Stan P: Standard Pressure
Norm T: Normal Temperature
Norm P: Normal Pressure

Ref temp units Changes the temperature units used for STP and NTP calculations.

Ref pressure units Changes the pressure units used for STP and NTP calculations.

BACK Returns to the Basic Configuration Menu (page 33).

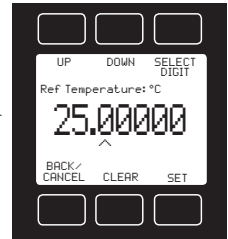
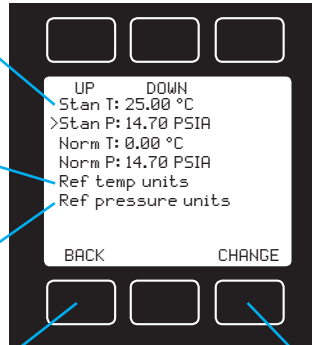

CHANGE Enters the value or unit selection screen for the selected parameter.

Using the STP/NTP menu, you can independently change the temperature or pressure references for STP and NTP. Your flow controller ships with Alicat default STP of 25°C and 1 atm (for flow units beginning with “S”), and an NTP of 0°C and 1 atm (for flow units beginning with “N”).

To make changes, follow these steps:

1. Select the desired pressure or temperature reference engineering unit by selecting **Ref temp units** or **Ref pressure units** and pressing **CHANGE**. Both normal and standard references use the same engineering units.
2. Select the temperature or pressure value you wish to modify, and press **CHANGE**.
3. At the confirmation screen, press **SET** to confirm your desired change.



Caution: Changes to STP/NTP references will alter your mass flow readings.

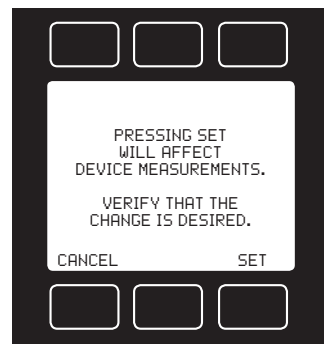

Advanced Setup

The Advanced Setup Menu lets you configure the display, zero band, averaging (for flow and pressure), and serial communications.

Menu → **Advanced Setup**

SENSOR SETUP Enters the Sensor Setup Menu (page 40).

COMM SETUP Enters the Communications Setup Menu (page 41).

DISP SETUP Enters the Display Setup Menu (below).

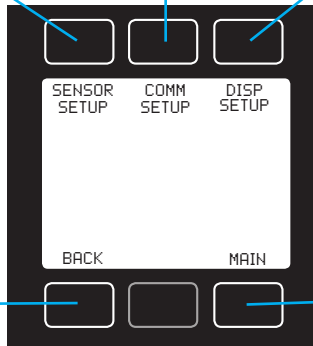

BACK Returns to the top-level Menu (page 17).

MAIN Exits to the Main Display (page 17).

Display Setup

The options in the Display Setup Menu adjust the contrast of the display and enable screen rotation.

Menu → Advanced Setup → **Display Setup**

LCD CONTRAST Sets the contrast level of the display. Press reset to revert to the default contrast level.

POWERUP -LIT- Automatically turns the backlight on when LIT is selected.

ROTATE DISP Rotates the display and buttons 180° for inverted installations.

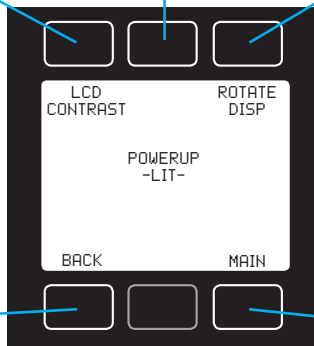
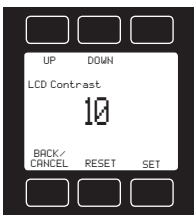

BACK Returns to the Setup Menu (above).

MAIN Exits to the Main Display (page 17).

Sensor Setup

The **Sensor Setup** Menu contains advanced settings that govern how the flow and pressure sensors report their data.

Menu → Advanced Setup → **Sensor Setup**

DISPLAY AS ZERO Defines the deadband threshold under which flow values are displayed as 0. (Max: 6.375%)

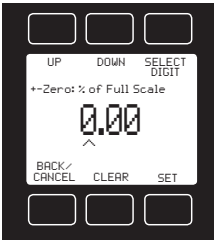

NUM OF DIGITS Sets the number of significant digits to display flow readings on-screen and in the serial data frame.

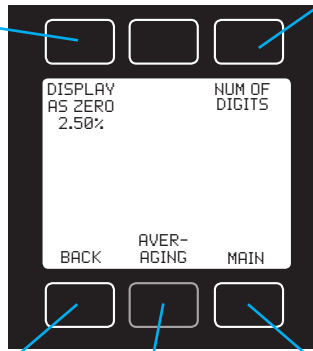

BACK Returns to the Advanced Setup Menu (page 39).

AVERAGING Adjusts the time constants of the geometric running averages for flow and pressure (1-255 ms).

MAIN Exits to the Main Display (page 17).

The zero band threshold (**DISPLAY AS ZERO**) is the value below which the flow controller displays all flow readings as “0” (no flow). This function also applies to gauge pressure readings when using the optional barometer. The default deadband is optimized for the model and range of the mass flow controller to ignore common noise sources. This can be changed to accommodate a zero dead band up to 6.375% of full scale and is rounded on the display. For example, if you set a deadband value of 0.25%, so on a 20-SLPM instrument, all readings below 0.05 SLPM would display as 0 SLPM.



Note: *Deadband settings do not affect the values reported in serial data.*

The **AVERAGING** button opens a submenu for adjusting the flow and pressure averaging, which are changed independently. Values roughly correspond to the time constant (in milliseconds) of the averaged values. Higher numbers generate a greater smoothing effect on rapidly fluctuating readings.

The maximum averaging time is 255 ms.

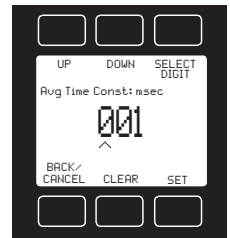

Configuring Serial Communications

You can operate the flow controller remotely via serial communication for easy streaming and logging of all data. Before connecting the flow controller to a computer, ensure that it is ready to communicate with your computer by checking the options in the **COMM SETUP** menu.

Menu ► Advanced Setup ► **Comm Setup**

UNIT ID Sets the serial unit ID (below):

@ = streaming mode
A-Z = polling mode

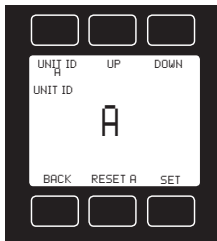

BACK Returns to the Advanced Setup Menu (page 39).

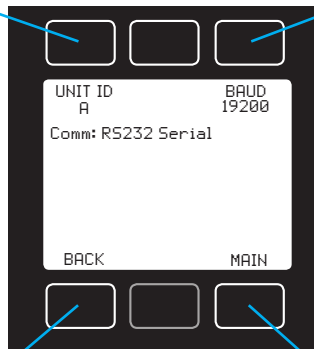

BAUD Sets the serial baud rate (below). Baud rates include: 2400, 9600, 19200, 38400, 57600 and 115200.

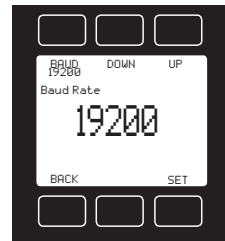

MAIN Exits to the Main Display (page 17).

Unit ID

The unit ID is the identifier that a computer uses to distinguish your flow controller from other Alicat devices when it is connected to a network. Using the unit ID letters A–Z, you can connect up to 26 devices to a computer at the same time via a single COM port. This is called polling mode (**page 43**). Unit ID changes take effect when you select **SET**.

If you select @ as the Unit ID, the flow controller enters streaming mode when you exit the menu (see **page 43**).



NOTE: Devices equipped with Modbus RTU will also have a Modbus ID that can be set separately from the unit ID.

Baud Rate

Baud rate is the speed at which digital devices transfer information. The flow controller defaults to a baud rate of 19200 baud (bits per second). If your computer or software uses a different baud rate, you must change the flow controller baud rate in the **BAUD** menu to match. Alternatively, you can change your computer's baud rate in Device Manager. Baud rate changes take effect once you press **SET**, but you may need to restart your computer software.

Serial Communication

Connecting your flow controller to a computer allows you to log the data that it generates. The flow controller communicates digitally through its communications connector and cable using a real or virtual COM port on your computer. This section of the manual shows you how to operate the flow controller using ASCII commands.

Establishing Communications

After connecting your flow controller using a communications cable, you will need to establish serial communications through a real or virtual COM port on your computer or programmable logic controller (PLC).

- If you have connected your device to a serial port, note its COM port number. This can be found in Windows Device Manager.
- If you have used a USB cable to connect your device to a Windows computer, in most cases it will recognize your USB as a virtual COM port. If it does not, download the appropriate USB device driver at alicat.com/drivers and note the COM port number as found in Windows Device Manager.
- The controller unit will be configured with the following settings:
 - **Baud:** 19200 (default; others can be used if the computer, its software and the Alicat device are set for the same rate)
 - **Data bits:** 8
 - **Stop bits:** 1
 - **Parity:** none
 - **Flow control:** none

Serial Terminal Application

Alicat's Serial Terminal is a preconfigured program for serial communications that functions much like the older Windows' HyperTerminal program.

Download Serial Terminal for free at alicat.com/drivers. Once downloaded, simply run SerialTerminal.exe. Enter the COM port number to which your device is connected and the baud rate of the flow controller. The default baud rate is 19200, but this is adjustable by entering the **SERIAL COMM** menu on your flow controller: **MENU** → **ADV SETUP** → **COMM SETUP** → **BAUD** (page 41).

Serial Streaming vs Polling



Note: In what follows, ↵ indicates an ASCII carriage return (decimal 13, hexadecimal D). For many devices, this is the same as hitting the Enter key. Serial commands are not case-sensitive.

Polling Mode

Your flow controller was shipped to you in polling mode with a unit ID of A, unless requested otherwise. Polling the flow controller returns a single line of data each time you request it. To poll your flow controller, simply enter its unit ID.

Poll the device: [unit ID]↵

Example: a↵ (polls unit A)

You can change the unit ID of a polling device by typing:

Change the unit ID: [current unit ID]@[desired unit ID]↵

Example: a@=b↵ (changes unit A to unit B)

You can also do this via the flow controller menu: **MENU** → **ADV SETUP** → **COMM SETUP** → **UNIT ID (page 41)**. Valid unit IDs are letters A–Z, and up to 26 devices may be connected at any one time, as long as each unit ID is unique.

Streaming Mode

In streaming mode, your flow controller continuously sends a line of live data at regular intervals without you having to request the data each time. Only one unit on a given COM port may be in streaming mode at a time. To put your flow controller into streaming mode, type:

Begin streaming: [unit ID]@=@↵

This is equivalent to changing the unit ID to “@”. To take the flow controller out of streaming mode, assign it a unit ID by typing:

Stop streaming: @@=[desired unit ID]↵

Example: @@=a↵ (stops and assigns unit ID of A)

When sending a command to a flow controller in streaming mode, the flow of data will not stop while the user is typing. This may make the commands you type unreadable. If the device does not receive a valid command, it will ignore it. If in doubt, simply hit ↵ and start again.

Note: The default streaming interval is 50 ms, but this can be increased by changing Register 91 while the device is in polling mode:

Set streaming interval: [unit ID] w91=[number of ms]↵

Example: aw91=500↵
(streams new data every 500 ms)

Taring

Before collecting flow data, be sure to tare your flow controller. If auto-tare is enabled, this can be accomplished by provided a setpoint of 0 for at least 2 seconds.

Manual taring can be accomplished serially through two separate commands. Taring flow sets the zero flow reading and must be done when no flow is passing through the flow controller:

Tare flow: [unit ID]v←

Example: av← (sets flow reading to zero)

For devices equipped with a barometer, the second tare aligns the internal absolute pressure sensor with the current barometer reading and must be done with the flow controller open to atmosphere:

Tare absolute pressure: [unit ID]pc←

Example: apc←

(aligns internal pressure to barometer)

Collecting Flow Data

Collect live flow data by typing the [unit ID] ← command or by setting your flow controller to streaming. Each line of data for live flow measurements appears in the format below, but unit ID is not present in streaming mode.

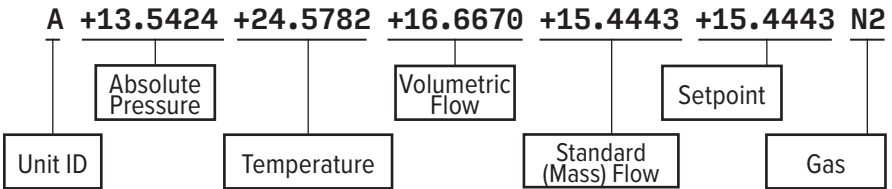

Single spaces separate each parameter, and each value is displayed in the chosen device engineering units, which may differ from the engineering units visible on the flow controller display (see “Choosing Engineering Units” on page 18). You can query the engineering units of the instant data frame by typing:

Query live data info: [unit ID]??d*←

Example: a??d*←

(returns the data frame descriptions)

Additional columns, including status codes (see “Status Messages” on page 8), may be present to the right of the gas label column. The unit ID appears in the data frame only when the flow controller is in polling mode.

Commanding a New Setpoint

Before attempting to send setpoints to your mass flow controller serially, confirm that its setpoint source is set to **Serial/Front Panel** by selecting **MENU → CONTROL → ADV CONTROL → SETPT SOURCE**.

There are two ways to command a new setpoint over a serial connection, as described below. In either of these methods, the data frame returns the new setpoint value when it has been accepted as a valid setpoint.

Sending Setpoints as Floating Point Numbers

This is how to send the desired setpoint value as a floating point number in the engineering units selected:

New setpoint: `as[setpoint as floating point number]↵`

Example: `as15.44↵` (setpoint of +15.44 SLPM)

When using a bidirectional mass flow controller, negative setpoints are sent by adding the minus sign (-):

Example: `as-15.44↵` (setpoint of -15.44 SLPM)

Sending Setpoints as Integers

In this method, your controller's **full scale range (FS)** is represented by a value of 64000, and a zero setpoint is represented by 0. To calculate your intended setpoint, use the following formula:

Integer value = $64000 \times [\text{desired setpoint}] / [\text{device FS}]$

Example 1: A desired setpoint of +15.44 SLPM on a 20-SLPM mass flow controller is calculated as $64000 \times 15.44 / 20.00 = 49408$. The command to assign the setpoint based on this integer value is:

New setpoint: `a[setpoint as integer where 64000 is FS]↵`

Example 1: `a49408↵` (setpoint of 15.44 SLPM)

Example 2: When using a bidirectional mass flow controller, 0 represents -100% of full scale, 32000 represents 0, and 64000 represents +100% of full scale. Use the following formula to calculate the integer value:

Integer value = $64000 \times [\text{desired setpoint} + \text{FS}] / [\text{device FS} \times 2]$

A desired setpoint of +15.44 SLPM on a 20-SLPM bidirectional mass flow controller is calculated as $64000 \times (15.44 + 20.00) / 40.00 = 56704$.

Example 3: A desired setpoint of -15.44 SLPM on the same bidirectional mass flow controller is calculated as:

Integer value = $64000 \times (-15.44 + 20.00) / 40.00 = 7296$

Using Gas Select™ and COMPOSER™

To reconfigure your flow controller to flow a different gas, look up its Gas Number (see “Gas List” on **page 52**). Then type:

Choose a gas: [unit ID]g[Gas Number]↵

Example 1: ag8↵ (reconfigures to flow nitrogen)

Example 2: ag206↵ (reconfigures to flow P-10)

COMPOSER™ user mixes are selected in the same way. All COMPOSER™ gas mixes have a Mix Number between 236 and 255.

Choose a user mix: [unit ID]g[Gas Number]↵

Example: ag255↵ (reconfigures for user mix 255)

Defining a new COMPOSER™ gas mix is faster using serial commands than using the front panel. The basic formula for this is:

[unit ID]gm [Mix Name] [Mix Number] [Gas1 %] [Gas1 Number] [Gas2 %]
[Gas2 Number]...↵

[Mix Name] Use a maximum of 6 letters (upper and/or lower case), numbers and symbols (space, period or hyphen only).

[Mix Number] Choose a number from 236 to 255. If a user mix with that number already exists, it will be overwritten. Use the number 0 to assign the next available number to your new gas. Gas numbers are assigned in descending order from 255.

[Gas1 %] [Gas1 Number]... For each gas, enter its molar percentage up to 2 decimal places, then its Gas Number (**page 52**). COMPOSER™ requires 2–5 gases, and the sum of all gas constituent percentages must equal 100.00%. After creating a mix, the controller will confirm the new gas:

Example 1: Create a mix of 71.35% helium, 19.25% nitrogen, and 9.4% carbon dioxide as Gas 252, called “MyGas1”.

Command:

agm MyGas1 252 71.35 7 19.25 8 9.4 4↵

Response: A 252 71.35% He 19.25% N2 9.40% CO2

Example 2: Create a mix of 93% methane, 3% ethane, 1% propane, 2% nitrogen, and 1% CO₂, using the next available gas number, called “MyGas2”.

Command:

agm MyGas2 0 93 2 3 5 1 12 2 8 1 4↵

Response: A 253 93.00% CH4 3.00% C2H6 1.00% C3H8 2.00% N2 1.00% CO2

Quick Command Guide



Note: Serial commands are not case-sensitive. For simplicity, we assume that the unit ID of the flow controller when not streaming is **a** in the listing that follows.

Change the unit ID: a@[desired unit ID]↵

Tare flow: av↵

**Tare absolute pressure
with barometer:** apc↵

(barometers are optional to controllers)

Poll the live data frame: a↵

Begin streaming data: a@=@↵

Stop streaming data: @@=[desired unit ID]↵

Set streaming interval: aw91=[number of milliseconds]↵

New setpoint: as[setpoint as floating point num.]↵

New setpoint: a[setpoint as integer where
64000 is full scale]↵

**Hold valve(s) at
current position:** ahp↵

Hold valve(s) closed: ahc↵

Cancel valve hold: ac↵

Query gas list info: a??g*↵

Choose a different gas: ag[Gas Number]↵

New COMPOSER™ mix: agm [Mix Name] [Mix Number] [Gas1 %]
[Gas1 #] [Gas2 %] [Gas2 #]...↵

Delete COMPOSER™ mix: agd [Mix #]↵

Query live data info: a??d*↵

Manufacturer info: a??m*↵

Firmware version: a??m9↵ or ave↵

Lock the front display: al↵

Unlock the display: au↵



If you have need of more advanced serial communication commands, please contact us or refer to the Serial Communications Primer: documents.alicat.com/alicat-serial-primer.pdf.

Troubleshooting

If you run into any trouble with your Alicat's installation or operation, please get in touch with us by phone, chat, or email. You'll also find help on our website alicat.com and in the pages that follow.

General Use

Issue: My Alicat does not turn on, or has trouble staying on.

Action: Check power and ground connections. Please reference the technical specifications to ensure you have the proper power for your model.

Issue: The buttons do not work, and the screen shows **LCK**.

Action: The flow controller buttons were locked out via a serial command. Press and hold all four outer buttons to unlock the interface.

Issue: I can't read the display easily.

Action: During the day, you can increase the visibility of the display by increasing the contrast (**MENU** → **ADV SETUP** → **DISP SETUP** → **LCD CONTRAST**). If you are working under low-light conditions, push the large Alicat button (located below the display) to turn on the backlight.

Issue: The analog output signal indicates values lower than what appears on my instrument's display .

Action: Analog signal voltage degrades over long distances. You can minimize this effect by using wires with a heavier gauge, especially in the ground wire.

Issue: How often do I need to calibrate my Alicat?

Action: Alicat recommends annual recalibrations. Check your flow controller's last calibration date by selecting **MENU** → **ABOUT** → **DEVICE INFO**. If it is time to recalibrate, request a recalibration at alicat.com/service.

Issue: I dropped my Alicat. Is it OK? Do I need to recalibrate?

Action: If it turns on and appears to respond normally, then it is probably OK. It may or may not need a recalibration. Give it a tare, and compare it against a known-good flow standard. If it checks out, keep using it, but tell us about the drop at your next annual recalibration so we can check it out for you.

Issue: How can I see temperature, pressure, or flow in different units?

Action: From the main menu, select **BASIC CONFIG** → **DEVICE UNITS**. From this menu, you can adjust temperature, pressure, or flow units. For more information, see [page 33](#).

Flow Readings

Issue: The live flow readings won't settle down.

Action: The flow controller is very fast, so it can detect subtle variations in flow that may go unnoticed by your other flow devices. This sensitivity can help detect problems with pumps or flow controllers. You can lessen this sensitivity by increasing the flow averaging (press **MENU** → **ADV SETUP** → **SENSOR SETUP** → **FLOW AVG**). Alicat mass flow controllers use PD or PD²I control loop algorithms to reach the setpoint given. These parameters are adjustable in the field. See **page 29** for a quick guide on tuning.

Issue: My controller won't reach its setpoint.

Action: The flow rate is related linearly to the pressure drop across the device. If there isn't enough of a pressure difference between the inlet and outlet, the controller may not be able to reach setpoint. Often, increasing the inlet pressure will fix this issue.

If increasing the pressure doesn't help, check to see if there is a clog. Teflon tape can often get stuck in the flow channel and block flow. Make sure to clean out any loose Teflon tape and never tape the last two threads to help avoid this issue.

Issue: My flow readings are negative.

Action: Request a zero setpoint to see if the flow returns to 0 after 2 seconds. Under conditions of no flow, a negative flow reading can indicate a poor tare. Ensure that auto tare is enabled and give the controller a zero setpoint for at least 2 seconds.

Issue: Does the Alicat work if it is laying down? Will it be accurate?

Action: Yes to both for small valve controllers! The flow controller is internally compensated for any changes in orientation, so you can use it sideways, on its back, or upside-down. S-series devices should be tared again after changing their orientation. Large valve controllers (MCR and MCRH-series) should be operated with the valve cylinder vertical and upright.

Issue: Can I put the Alicat on top of a vibrating device? Will it be accurate?

Action: Yes for small valve controllers. The flow controller is internally compensated for any changes in orientation. Noise will increase if the flow controller is vibrating. Large valve controllers (MCR and MCRH-series) are not recommended for use on vibrating surfaces.

Issue: My controller does not agree with another mass flow meter I have in line.

Action: Check the STP or NTP settings (**MENU → BASIC CONFIG → STP/NTP**) to ensure that your standardized temperature and pressure references match those of your other flow calibrator. Also check that your device's Gas Select™ is set to the right gas or mixture.

Issue: My flow readings won't change when flow changes.

Action: If your flow readings won't change regardless of actual flow, your flow sensor may be damaged. Please contact Alicat to troubleshoot.

Issue: Can I use the Alicat with other gases?

Action: Yes! Your flow controller is designed specifically to work with many different gases. Gas Select™ (**MENU → BASIC CONFIG → GAS**) includes up to 130 preloaded gases and gas mixes, or you can define your own using COMPOSER™. If your desired gas is not listed, please contact Alicat to ensure compatibility.

Serial Communications

Issue: I can't communicate to the Alicat when it is connected to my PC.

Action:

1. Make sure the baud rate your software and COM Port require is the one your flow controller is using (**MENU → ADV SETUP → COMM SETUP → BAUD**).
2. Check the flow controller unit ID (**MENU → ADV SETUP → COMM SETUP → UNIT ID**) to make sure you are addressing it properly with your serial commands.
3. Check the pinout (see **page 56** or alicat.com/pinouts)
4. Make sure the COM number matches the one your software is using to connect to the flow controller.
5. On the external serial communications device (PC, PLC, etc.), be sure that the flow control (hand-shaking) settings are set as on **page 42**.

Still experiencing issues?

Issue: None of the above helped.

Action: We're here to help! Give us a call (**1-888-290-6060**) during our normal business hours (7am–5pm Mountain Standard Time) to get help from a friendly and capable applications engineer. Or, go to alicat.com and start a live chat. Is it after hours? Send an email to info@alicat.com, and we'll get in touch with you as soon as we can.

Additionally, our troubleshooting resources online are more detailed than the manual. Please visit alicat.com/support.

Maintenance

Cleaning

Your flow controller requires no periodic cleaning, provided that it has been flowing clean, dry gas. If necessary, the outside of the device can be cleaned with a soft dry cloth. Alicat also offers remote panels and ingress protection for some models used in hazardous or remote applications.



If you suspect that debris or other foreign material has entered your device, do not take apart the flow body to clean it, as this will negate its NIST-traceable calibration. Please contact Alicat for cleaning.

Recalibration

The recommended period for recalibration is once every year. A label located on the back of the device lists the most recent calibration date. This date is also stored inside your flow controller and is visible by selecting **MENU** → **ABOUT** → **DEVICE INFO**.

When it is time for your flow controller's annual recalibration, contact us by phone or live chat to set it up. Or, send an email to service@alicat.com, or fill out the form at alicat.com/service. We'll ask for your device's serial number and your contact information and send you an email with instructions for returning the flow controller to us.

Replacement Accessories

Please contact Alicat to order replacements for any accessories.

For repair, recalibration, or recycling of this product contact:

Alicat Scientific, Inc.

service@alicat.com • alicat.com

7641 N Business Park Drive Tucson, AZ 85743 USA

1-888-290-6060

Technical Specifications and Dimensional Drawings

Please visit alicat.com/specs to find the complete operating specifications and dimensional drawings for your Alicat mass flow meter.

Gas List

#	Short Name	Long Name
0	Air	Air (Clean Dry)
1	Ar	Argon
2	CH4	Methane
3	CO	Carbon Monoxide
4	CO2	Carbon Dioxide
5	C2H6	Ethane
6	H2	Hydrogen
7	He	Helium
8	N2	Nitrogen
9	N2O	Nitrous Oxide
10	Ne	Neon
11	O2	Oxygen
12	C3H8	Propane
13	nC4H10	Normal Butane
14	C2H2	Acetylene
15	C2H4	Ethylene (Ethene)
16	iC4H10	Isobutane ²
17	Kr	Krypton
18	Xe	Xenon
19	SF6	Sulfur Hexafluoride ¹
20	C-25	25% CO ₂ , 75% Ar
21	C-10	10% CO ₂ , 90% Ar
22	C-8	8% CO ₂ , 92% Ar
23	C-2	2% CO ₂ , 98% Ar
24	C-75	75% CO ₂ , 25% Ar
25	He-25	25% He, 75% Ar
26	He-75	75% He, 25% Ar
27	A1025	90% He, 7.5% Ar, 2.5% CO ₂
28	Star29	Stargon CS (90% Ar, 8% CO ₂ , 2% O ₂)
29	P-5	5% CH ₄ , 95% Ar
30	NO	Nitric Oxide ²
31	NF3	Nitrogen Trifluoride ²
32	NH3	Ammonia ²
33	Cl2	Chlorine ^{2,4}
34	H2S	Hydrogen Sulfide ²

#	Short Name	Long Name
35	SO2	Sulfur Dioxide ^{2,4}
36	C3H6	Propylene ²
80	1Buten	1-Butylene ²
81	cButen	Cis-Butene (cis-2-Butene) ²
82	iButen	Isobutylene
83	tButen	Trans-2-Butene ²
84	COS	Carbonyl Sulfide ²
85	DME	Dimethylether (C ₂ H ₆ O) ²
86	SiH4	Silane ²
100	R-11	Trichlorofluoromethane (CCl ₃ F) ^{2,3}
101	R-115	Chloropentafluoroethane (C ₂ ClF ₅) ^{2,3}
102	R-116	Hexafluoroethane (C ₂ F ₆) ²
103	R-124	Chlorotetrafluoroethane (C ₂ HClF ₄) ^{2,3}
104	R-125	Pentafluoroethane (CF ₃ CHF ₂) ^{2,3}
105	R-134A	Tetrafluoroethane (CH ₂ FCF ₃) ^{2,3}
106	R-14	Tetrafluoromethane (CF ₄) ²
107	R-142b	Chlorodifluoroethane (CH ₃ CClF ₂) ^{2,3}
108	R-143a	Trifluoroethane (C ₂ H ₃ F ₃) ^{2,3}
109	R-152a	Difluoroethane (C ₂ H ₄ F ₂) ²
110	R-22	Difluoromono-chloromethane (CHClF ₂) ^{2,3}
111	R-23	Trifluoromethane (CHF ₃) ^{2,3}
112	R-32	Difluoromethane (CH ₂ F ₂) ^{2,3}
113	R-318	Octafluorocyclobutane (C ₄ F ₈) ²
114	R-404A	44% R-125, 4% R-134A, 52% R-143A ^{2,3}
115	R-407C	23% R-32, 25% R-125, 52% R-143A ^{2,3}
116	R-410A	50% R-32, 50% R-125 ^{2,3}
117	R-507A	50% R-125, 50% R-143A ^{2,3}
140	C-15	15% CO ₂ , 85% Ar
141	C-20	20% CO ₂ , 80% Ar
142	C-50	50% CO ₂ , 50% Ar
143	He-50	50% He, 50% Ar
144	He-90	90% He, 10% Ar
145	Bio5M	5% CH ₄ , 95% CO ₂
146	Bio10M	10% CH ₄ , 90% CO ₂
147	Bio15M	15% CH ₄ , 85% CO ₂

#	Short Name	Long Name
148	Bio20M	20% CH ₄ , 80% CO ₂
149	Bio25M	25% CH ₄ , 75% CO ₂
150	Bio30M	30% CH ₄ , 70% CO ₂
151	Bio35M	35% CH ₄ , 65% CO ₂
152	Bio40M	40% CH ₄ , 60% CO ₂
153	Bio45M	45% CH ₄ , 55% CO ₂
154	Bio50M	50% CH ₄ , 50% CO ₂
155	Bio55M	55% CH ₄ , 45% CO ₂
156	Bio60M	60% CH ₄ , 40% CO ₂
157	Bio65M	65% CH ₄ , 35% CO ₂
158	Bio70M	70% CH ₄ , 30% CO ₂
159	Bio75M	75% CH ₄ , 25% CO ₂
160	Bio80M	80% CH ₄ , 20% CO ₂
161	Bio85M	85% CH ₄ , 15% CO ₂
162	Bio90M	90% CH ₄ , 10% CO ₂
163	Bio95M	95% CH ₄ , 5% CO ₂
164	EAN-32	32% O ₂ , 68% N ₂
165	EAN	36% O ₂ , 64% N ₂
166	EAN-40	40% O ₂ , 60% N ₂
167	HeOx20	20% O ₂ , 80% He
168	HeOx21	21% O ₂ , 79% He
169	HeOx30	30% O ₂ , 70% He
170	HeOx40	40% O ₂ , 60% He
171	HeOx50	50% O ₂ , 50% He
172	HeOx60	60% O ₂ , 40% He
173	HeOx80	80% O ₂ , 20% He
174	HeOx99	99% O ₂ , 1% He
175	EA-40	Enriched Air-40% O ₂
176	EA-60	Enriched Air-60% O ₂
177	EA-80	Enriched Air-80% O ₂
178	Metab	Metabolic Exhalant (16% O ₂ , 78.04% N ₂ , 5% CO ₂ , 0.96% Ar)
179	LG-4.5	4.5% CO ₂ , 13.5% N ₂ , 82% He
180	LG-6	6% CO ₂ , 14% N ₂ , 80% He
181	LG-7	7% CO ₂ , 14% N ₂ , 79% He
182	LG-9	9% CO ₂ , 15% N ₂ , 76% He

#	Short Name	Long Name
183	HeNe-9	9% Ne, 91% He
184	LG-9.4	9.4% CO ₂ , 19.25% N ₂ , 71.35% He
185	SynG-1	40% H ₂ , 29% CO, 20% CO ₂ , 11% CH ₄
186	SynG-2	64% H ₂ , 28% CO, 1% CO ₂ , 7% CH ₄
187	SynG-3	70% H ₂ , 4% CO, 25% CO ₂ , 1% CH ₄
188	SynG-4	83% H ₂ , 14% CO, 3% CH ₄
189	NatG-1	93% CH ₄ , 3% C ₂ H ₆ , 1% C ₃ H ₈ , 2% N ₂ , 1% CO ₂
190	NatG-2	95% CH ₄ , 3% C ₂ H ₆ , 1% N ₂ , 1% CO ₂
191	NatG-3	95.2% CH ₄ , 2.5% C ₂ H ₆ , 0.2% C ₃ H ₈ , 0.1% C ₄ H ₁₀ , 1.3% N ₂ , 0.7% CO ₂
192	CoalG	50% H ₂ , 35% CH ₄ , 10% CO, 5% C ₂ H ₄
193	Endo	75% H ₂ , 25% N ₂
194	HHO	66.67% H ₂ , 33.33% O ₂
195	HD-5	LPG: 96.1% C ₃ H ₈ , 1.5% C ₂ H ₆ , 0.4% C ₃ H ₆ , 1.9% n-C ₄ H ₁₀
196	HD-10	LPG: 85% C ₃ H ₈ , 10% C ₃ H ₆ , 5% n-C ₄ H ₁₀
197	OCG-89	89% O ₂ , 7% N ₂ , 4% Ar
198	OCG-93	93% O ₂ , 3% N ₂ , 4% Ar
199	OCG-95	95% O ₂ , 1% N ₂ , 4% Ar
200	FG-1	2.5% O ₂ , 10.8% CO ₂ , 85.7% N ₂ , 1% Ar
201	FG-2	2.9% O ₂ , 14% CO ₂ , 82.1% N ₂ , 1% Ar
202	FG-3	3.7% O ₂ , 15% CO ₂ , 80.3% N ₂ , 1% Ar
203	FG-4	7% O ₂ , 12% CO ₂ , 80% N ₂ , 1% Ar
204	FG-5	10% O ₂ , 9.5% CO ₂ , 79.5% N ₂ , 1% Ar
205	FG-6	13% O ₂ , 7% CO ₂ , 79% N ₂ , 1% Ar
206	P-10	10% CH ₄ 90% Ar
210	D-2	Deuterium

1 Sulfur hexafluoride is a highly potent greenhouse gas monitored under the Kyoto Protocol.

2 S-series units only

3 Under the Montreal Protocol and Kigali Amendment, the production and consumption of these ozone-depleting substances (ODS) is being or has been phased out. It is recommended you ensure compliance with this universally ratified treaty before attempting to use these gases, in addition to R113, R-123, and R-141b.

4 S-series with PCA valves only

Engineering Units

True Mass

Flow Units

Label	Notes
mg/s	milligram per second
mg/m	milligram per minute
g/s	gram per second
g/m	gram per minute
g/h	gram per hour
kg/m	kilogram per minute
kg/h	kilogram per hour
oz/s	ounce per second
oz/m	ounce per minute
lb/m	pound per minute
lb/h	pound per hour

Temperature Units

Label	Notes
°C	degrees Celsius
°F	degrees Fahrenheit
K	Kelvin
°R	degrees Rankine

Time Units

Label	Notes
h:m:s	hours:minutes:seconds
ms	milliseconds
s	seconds
m	minutes
hour	hours
day	days

Flow Units

Volumetric	Std.	Normal	Notes
uL/m	SuL/m	NuL/m	microliter per minute
mL/s	SmL/s	NmL/s	milliliter per second
mL/m	SmL/m	NmL/m	milliliter per minute
mL/h	SmL/h	NmL/h	milliliter per hour
L/s	SL/s	NL/s	liter per second
LPM	SLPM	NLPM	liter per minute
L/h	SL/h	NL/h	liter per hour
US GPM			US gallon per minute
US GPH			US gallon per hour
CCS	SCCS	NCCS	cubic centimeter per second
CCM	SCCM	NCCM	cubic centimeter per minute
cm ³ /h	Scm ³ /h	Ncm ³ /h	cubic centimeter per hour
m ³ /m	Sm ³ /m	Nm ³ /m	cubic meter per minute
m ³ /h	Sm ³ /h	Nm ³ /h	cubic meter per hour
m ³ /d	Sm ³ /d	Nm ³ /d	cubic meter per day
in ³ /m	Sin ³ /m		cubic inch per minute
CFM	SCFM		cubic foot per minute
CFH	SCFH		cubic foot per hour
CFD	SCFD		cubic foot per day
	kSCFM		1000 cubic feet per minute
count	count	count	setpoint count, 0–64000
%	%	%	percent of full scale

Pressure Units

Absolute or Barometric	Gauge	Notes
PaA	PaG	pascal
hPaA	hPaG	hectopascal
kPaA	kPaG	kilopascal
MPaA	MPaG	megapascal
mbarA	mbarG	millibar
barA	barG	bar
g/cm ² A	g/cm ² G	gram force per square centimeter
kg/cm ² A	kg/cm ² G	kilogram force per square centimeter
PSIA	PSIG	pound force per square inch
PSFA	PSFG	pound force per square foot
mTorrA	mTorrG	millitorr
torrA	torrG	torr
mmHgA	mmHgG	millimeter of mercury at 0°C
inHgA	inHgG	inch of mercury at 0°C
mmH ₂ O A	mmH ₂ O G	millimeter of water at 4°C (NIST conventional)
mmH ₂ O A	mmH ₂ O G	millimeter of water at 60°C
cmH ₂ O A	cmH ₂ O G	centimeter of water at 4°C (NIST conventional)
cmH ₂ O A	cmH ₂ O G	centimeter of water at 60°C
inH ₂ O A	inH ₂ O G	inch of water at 4°C (NIST conventional)
inH ₂ O A	inH ₂ O G	inch of water at 60°C
atm		atmosphere
m asl		meter above sea level
ft asl		foot above sea level
V		volt
count	count	setpoint count, 0–64000
%	%	percent of full scale

Optional Pinouts

Additional Pinouts

Individual pinouts available at www.alicat.com/pinout



Due to variance in cable manufacturing, please identify proper wiring/pins via continuity check & color when using blunt cut multi-strand cables.

Locking Industrial Connector Pinouts

If your Alicat Instrument was ordered with a Six Pin Locking Industrial connection, please be sure to reference the following pinout diagram.

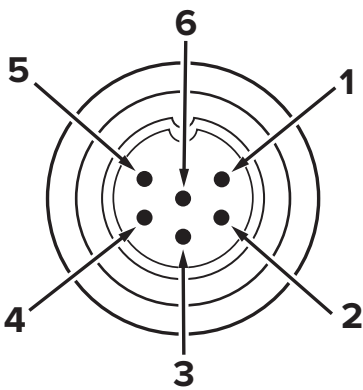

Male Connector: Cable

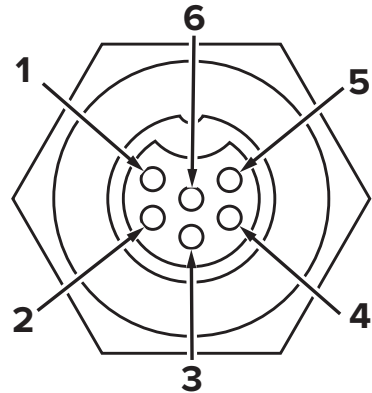

Female Connector: Device

Pin	Function
1	Power In (+)
2	RS-232 TX / RS-485(+)
3	RS-232 RX / RS-485(-)
4	Meters / Gauges: Remote Tare (Ground to Tare) Controllers: Analog Setpoint Input
5	Ground (common for power, communications and signals)
6	Signal Out (Voltage or Current as ordered)

The above pinout is applicable to all the flow meters and controllers ordered with the industrial connector. The availability of different output signals depends on the flow controller options ordered.

M12 Connector Pinouts

If your Alicat Instrument was ordered with the M12 connection, please be sure to reference the following pin-out diagram.

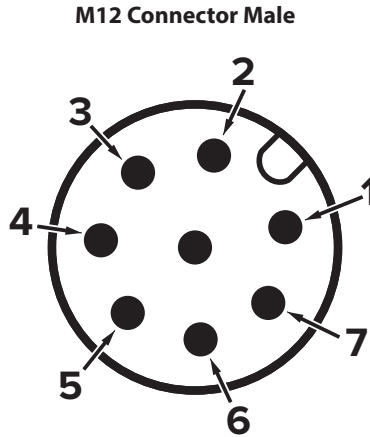

Pin	Function
1	0–5 Vdc (or optional 0–10 Vdc) Output Signal
2	Power In +24 VDC, 1 A recommended for most models
3	Serial RS-232 RX / RS-485(-) Input Signal (receive)
4	Meters / Gauges = Remote Tare (Ground to Tare) Controllers = Analog Set-Point Input
5	Serial RS-232 TX / RS-485(+) Output Signal (send)
6	Static 5.12 Vdc [or optional Secondary Analog Output (4–20 mA, 5 Vdc, 10 Vdc) or Basic Alarm]
7	Ground (common for power, digital communications, analog signals and alarms)
8	Inactive (or optional 4–20 mA Primary Output Signal)

Note: The above pin-out is applicable to all the flow meters and controllers with the M12 connector. The availability of different output signals depends on the options ordered. Optional configurations are noted on the unit's calibration sheet.



Due to variance in cable manufacturing, please identify proper wiring/pins via continuity check & color when using blunt cut multi-strand cables.

Individual pinouts available at www.alicat.com/pinout

9 pin D-Sub Common Pinouts

If your instrument was ordered with a DB9 connection, be sure to check the calibration label on the device or the calibration data sheet and reference the appropriate pinout diagram.

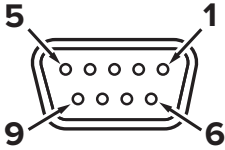

Male Connector: Cable

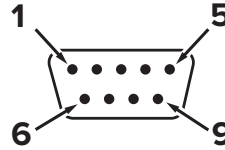

Female Connector: Device

Common 9-pin D-Sub Pinouts

Pin	DB9 (Female) DB9M (Male)	DB9A / DB9K	DB9R	DB9T	DB9U
1	Current Out	NC	TX (+)	TX (+)	RX (-)
2	Analog Out 2	Analog Out	Analog Out	Analog Out	Analog Out
3	RX (-)	Power In	Analog In	Power In	Power In
4	Analog In	Ground	Ground	Ground	Ground
5	TX (+)	TX (+)	NC	NC	NC
6	Analog Out	Analog In	RX (-)	Analog In	Analog In
7	Power In	Ground	Power In	Ground	Ground
8	Ground	Ground	Ground	Ground	Ground
9	Ground	RX (-)	Ground	RX (-)	TX (+)

Key of Terms:

Current Out
Not Connected or optional 4–20 mA analog output signal

Analog In
Setpoint for controllers or remote tare function for meters

Analog Out
0–5 Vdc Output Signal (or 0–10 Vdc optional)

Analog Out 2
5.12 Vdc or Optional Secondary Analog Output

TX (+)
Serial RS-232 TX or RS-485(+)

RX (-)
Serial RS-232 RX or RS-485(-)

NC Not Connected

Power In (+Vdc)

Ground
Common for power, digital and analog signals, and alarms

Additional 9-pin D-Sub Pinouts

Pin	DB9B	DB9G	DB9H	DB9I	DB9N
1	Analog Out 2	RX (-)	TX (+)	NC	Power In
2	Analog Out	Analog Out	Analog Out	Analog Out	Analog In
3	Power In	Ground	Analog In	Power In	Analog Out
4	Ground	Power In	RX (-)	Ground	NC
5	Ground	Ground	Analog Out 2	NC	Ground
6	Analog In	TX (+)	NC	Analog In	Ground
7	Ground	Analog In	Power In	Ground	RX (-)
8	TX (+)	Current Out	Ground	RX (-)	TX (+)
9	RX (-)	Ground	Ground	TX (+)	NC5

15 pin D-Sub Common Pinouts

If your instrument was ordered with a DB15 connection, be sure to check the calibration label on the device or the calibration data sheet and reference the appropriate pinout diagram.

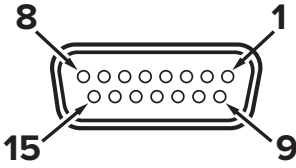

Male Connector: Cable

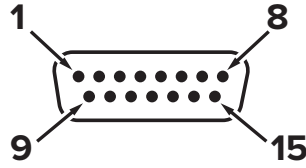

Female Connector: Device

Pin	DB15	DB15A	DB15B	DB15H	DB15K	DB15O	DB15S
1	Ground	Ground	Ground	NC	NC	Ground	Ground
2	Analog Out	Analog Out	Analog Out	RX (-)	Analog Out	NC	Analog Out
3	Ground	Analog In	NC	NC	NC	NC	NC
4	NC	Ground	NC	NC	NC	Analog Out	NC
5	Power In	Ground	Power In	Ground	Ground	Power In	Ground
6	NC	Ground	NC	Analog Out	NC	NC	NC
7	NC	Power In	NC	Ground	Power In	Analog In	NC
8	Analog In	TX (+)	Analog In	NC	Analog In	NC5	Analog In
9	Ground	Ground	Ground	NC	Analog Out 2	Ground	Ground
10	Ground	NC	Ground	Analog Out 2	NC	Ground	Ground
11	Analog Out 2	NC	Analog Out 2	Power In	Ground	Analog Out 2	Analog Out 2
12	NC	Analog Out 2	NC	Ground	Ground	NC	RX (-)
13	RX (-)	NC	NC	NC	RX (-)	NC	Power In
14	Ground	NC	RX (-)	Analog In	TX (+)	RX (-)	TX (+)
15	TX (+)	RX (-)	TX (+)	TX (+)	Ground	TX (+)	Ground

Key of Terms:

Current Out

Not Connected

Analog In

Setpoint for controllers or remote tare function for meters

Analog Out

0–5 Vdc Output Signal (or 0–10 Vdc optional)

Analog Out 2

5.12 Vdc or Optional Secondary Analog Output

TX (+)

Serial RS-232 TX or RS-485(+)

RX (-)

Serial RS-232 RX or RS-485(-)

NC Not Connected

Power In (+Vdc)

Ground

Common for power, digital communications, analog signals and alarms



Due to variance in cable manufacturing, please identify proper wiring/pins via continuity check & color when using blunt cut multi-strand cables.

Individual pinouts available at www.licat.com/pinout

Additional Information for Alicat CSA and ATEX Approved Devices



EEx nA IIC T4
Class I, Div. 2 Group A, B, C and D T4
24 Vdc, 0.800A max
Class I, Zone 2 AEx nA IIC T4

WARNINGS:



**EXPLOSION HAZARD – DO NOT DISCONNECT
WHILE CIRCUIT IS LIVE UNLESS AREA IS KNOWN
TO BE NON-HAZARDOUS.**



**EXPLOSION HAZARD – SUBSTITUTION OF
COMPONENTS MAY IMPAIR SUITABILITY FOR
CLASS I, DIVISION 2.**

Alicat CSA / ATEX approved devices are equipped with a locking connector. Please see page 56 to page 59 for the correct power and signal connections for each type of connector.

See the following page for special conditions regarding the use of these units!

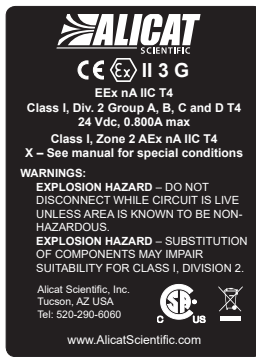

USE of Alicat instruments (L, LC, LCR, M, MW, MS, MC, MCW, MCS, MCR, MCRW, MCRS, MCD, P, PS, PC, PCD, PCS, PCR and PCRS product families) in Class 1 Division 2 applications.



CSA certifies the use of this product for general use as well as use in hazardous locations as defined by Class 1 Division 2 Group A, B, C and D T4.

CSA certification is indicated by the product label as shown below and not by the statements in this, or any accompanying documentation.

Special Conditions:

To comply with CSA certification the following information is included in the product literature:

- When equipment is properly labeled, it is suitable in Class I, Division 2, Group A, B, C and D, T4
 - Tamb. -40°C to +50°C
- Electrical Rating 24Vdc, 0.800A max
- Instruments shall be powered by a CSA certified, UL listed, Class II external power supply suitable for the application
- Instruments shall be housed in an enclosure with a minimum IP54 rating or location providing equivalent protection
- Instrument's final approval shall be provided by the local authority having jurisdiction

USE of Alicat instruments (L, LC, LCR, M, MW, MS, MC, MCD, MCW, MCS, MCR, MCRW, MCRS, P, PS, PC, PCD, PCS, PCR and PCRS product families) in applications requiring ATEX Class 1 Zone 2 Certification.

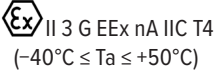

Properly labeled Alicat instruments comply to the following ATEX standard:

The examination certificate was issued by the CSA in accordance with accepted practices and procedures. This confirms compliance with the European ATEX Directive or Group II Category 3G equipment.

ATEX certification is indicated by the product label as shown above and not by the statements in this, or any accompanying documentation.

Special Conditions:

- Properly labeled equipment is only certified for use in ambient temperatures in the range of -40°C to +50°C only
- Electrical Rating 24Vdc, 0.800A max
- Instruments shall be powered by a CSA certified, UL listed, Class II external power supply suitable for the application
- Instruments shall be housed in an enclosure with a minimum IP54 rating or location providing equivalent protection
- Instrument's final approval shall be provided by the local authority having jurisdiction

Limited Lifetime Warranty

Alicat Scientific, Inc. warrants to the original purchaser (hereinafter referred to as “Buyer”) that instruments manufactured by Alicat Scientific (hereinafter referred to as “Product”) shall be free from defects in materials and workmanship for the life of the Products.

Under this warranty, the Products will be repaired or replaced at manufacturer’s option, without charge for parts or labor when the Product is carried or shipped prepaid to the factory together with proof of purchase.

The foregoing shall constitute the exclusive and sole remedy in lieu of other remedies of the Buyer for any breach by Alicat Scientific of this warranty to the maximum extent permitted by law.

This warranty does not apply to any Product which has not been installed or used in accordance with the Product operation and installation specifications provided to Buyer verbally or in writing by Alicat Scientific for the proper and normal use of the Product.

Buyer agrees hereunder that Alicat reserves the right to void any warranty, written or implied, if upon Alicat’s examination of Product shall disclose to Alicat’s satisfaction that the Product failure was due solely, or in part, to accident, misuse, neglect, abuse, alteration, improper installation, unauthorized repair or improper testing by Buyer or agent of Buyer.

Alicat Scientific shall not be liable under any circumstances for indirect, special, consequential, or incidental damages in connection with, or arising out of, the sale, performance, or use of the Products covered by this warranty.

Alicat Scientific does not recommend, warrant or assume responsibility for the use of the Products in life support applications or systems.

Alicat’s warranties as herein above set forth shall not be enlarged, diminished or affected by, and no obligation or liability shall arise or grow out

of Alicat’s rendering of technical advice in connection with Buyer’s order of the Products furnished hereunder.

If Product becomes obsolete, Alicat Scientific, at its own discretion, reserves the right to repair the Product with available replacement parts or upgrade the Product to a current, commercially available version of the original Product. Should upgrading the Product be deemed necessary by Alicat, Buyer hereby agrees to pay an upgrade fee equal to seventy percent of the retail value of the replacement Product. Alicat Scientific hereunder makes no claim that replacement Products will look, function or operate in the same or similar manner as the original product.

When a Product is returned to Alicat Scientific for recalibration this service is considered normal preventative maintenance. Recalibration of Product shall not be treated as a warranty service unless recalibration of Product is required as the result of repairs to Product pursuant to this Warranty. Failure of Buyer to send Product to Alicat Scientific for recalibration on a yearly basis after a period of 36 months from date of manufacture will remove any and all obligations regarding repair or replacement of Product as outlined by this Warranty to Buyer from Alicat Scientific.

This Warranty is in lieu of all other relevant warranties, expressed or implied, including the implied warranty of merchantability and the implied warranty of fitness for a particular purpose, and any warranty against infringement of any patent.

Continued use or possession of Products after expiration of the applicable warranty period stated above shall be conclusive evidence that the warranty is fulfilled to the full satisfaction of Buyer.

Alicat makes no warranty as to experimental, non-standard or developmental Products.

Accessories purchased from Alicat are not covered by this warranty.

Notice: Alicat Scientific, Inc. reserves the right to make any changes and improvements to the products described in this manual at any time and without notice. This manual is copyrighted. This document may not, in whole or in part, be copied, reproduced, translated, or converted to any electronic medium or machine readable form, for commercial purposes, without prior written consent from the copyright holder.

Note: Although we provide assistance on Alicat Scientific products both personally and through our literature, it is the complete responsibility of the user to determine the suitability of any product to their application.

The product complies with the requirements of the Low Voltage Directive 2014/35/EU, the EMC Directive 2014/30/EU and the RoHS Directive 2011/65/EU and carries the CE Marking accordingly. Contact the manufacturer for more information.



Flow Controller Menu Map

Start Here

* Main Display

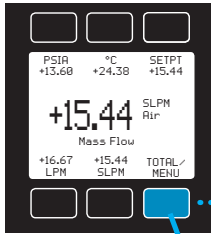

Optional
Flow
Totalizer

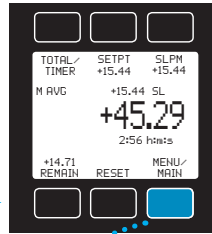

Without
Flow
Totalizer

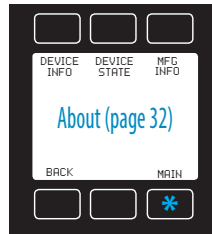

* Press MAIN to return to the Main Display.

