

User Guide

Vaisala HUMICAP[®] Handheld Humidity and
Temperature Meter

HM70



VAISALA

PUBLISHED BY

Vaisala Oyj
Vanha Nurmijärventie 21, FI-01670 Vantaa, Finland
P.O. Box 26, FI-00421 Helsinki, Finland
+358 9 8949 1

Visit our Internet pages at www.vaisala.com.

© Vaisala 2020

No part of this document may be reproduced, published or publicly displayed in any form or by any means, electronic or mechanical (including photocopying), nor may its contents be modified, translated, adapted, sold or disclosed to a third party without prior written permission of the copyright holder. Translated documents and translated portions of multilingual documents are based on the original English versions. In ambiguous cases, the English versions are applicable, not the translations.

The contents of this document are subject to change without prior notice.

Local rules and regulations may vary and they shall take precedence over the information contained in this document. Vaisala makes no representations on this document's compliance with the local

rules and regulations applicable at any given time, and hereby disclaims any and all responsibilities related thereto.

This document does not create any legally binding obligations for Vaisala towards customers or end users. All legally binding obligations and agreements are included exclusively in the applicable supply contract or the General Conditions of Sale and General Conditions of Service of Vaisala.

This product contains software developed by Vaisala or third parties. Use of the software is governed by license terms and conditions included in the applicable supply contract or, in the absence of separate license terms and conditions, by the General License Conditions of Vaisala Group.

Table of contents

1.	About this document	7
1.1	Version information.....	7
1.2	Related manuals.....	7
1.3	Documentation conventions.....	8
1.4	Trademarks.....	9
2.	Product overview	10
2.1	Introduction to HM70.....	10
2.1.1	Basic features and options.....	11
2.1.2	Overview of probes.....	11
3.	MI70 indicator	13
3.1	MI70 indicator parts.....	13
3.2	Installing and recharging MI70 batteries.....	13
3.2.1	MI70 battery status information.....	14
3.3	MI70 first start-up settings.....	15
3.4	Changing the rechargeable battery pack.....	15
4.	Taking measurements	17
4.1	Basic measuring steps.....	17
4.2	Errors caused by temperature differences.....	17
4.3	Measuring multiple parameters simultaneously.....	18
5.	Displays and menus	20
5.1	Basic display.....	20
5.2	Graphical display.....	21
5.3	Main menu.....	21
5.4	MI70 status icons.....	22
6.	Settings	24
6.1	Setting actual pressure value and unit.....	24
6.2	Display settings.....	25
6.2.1	Selecting parameters and units.....	25
6.2.2	Rounding.....	25
6.2.3	Holding and saving the display.....	26
6.3	User interface settings.....	27
6.3.1	Selecting language.....	27
6.3.2	Correcting language selection.....	27
6.3.3	Configuring automatic power off.....	28
6.3.4	Programming shortcut keys.....	28
6.3.5	Configuring button tones and backlight.....	29
6.4	Date and time.....	29
6.5	Setting calibration reminder.....	30
6.6	Device information.....	30
6.7	Factory settings.....	31

- 6.8 Recording and viewing data..... 32
 - 6.8.1 Recording data..... 32
 - 6.8.2 Viewing recorded data..... 32
 - 6.8.3 Checking MI70 memory status..... 32
 - 6.8.4 Clearing data memory..... 33
 - 6.8.5 Transferring recorded data to PC with MI70 Link..... 33
- 6.9 Other functions..... 34
 - 6.9.1 Setting an alarm..... 34
 - 6.9.2 Selecting and scaling analog output..... 35
 - 6.9.3 Chemical purge (optional)..... 36
 - 6.9.4 Sensor preheat (optional)..... 36
- 7. Calibrating and adjusting transmitters 39**
 - 7.1 HM70 in checking and adjusting..... 39
 - 7.1.1 Calibration cables..... 39
 - 7.2 Calibrating and adjusting HMT120 and HMT130 series transmitters..... 39
 - 7.2.1 Field checking and adjustment of HMT120/HMT130 using a calibrated reference probe..... 41
 - 7.2.2 1-point adjustment of HMT120/HMT130 using a calibrator..... 41
 - 7.2.3 2-point adjustment of HMT120/HMT130 using a calibrator..... 42
 - 7.2.4 LiCl-NaCl adjustment of HMT120/HMT130..... 43
 - 7.3 Calibrating and adjusting HMT330 series and PTU300 series transmitters..... 43
 - 7.3.1 Field checking and adjustment of HMT330/PTU300 using a calibrated reference probe..... 45
 - 7.3.2 1-point adjustment of HMT330/PTU300 using a calibrator..... 45
 - 7.3.3 2-point adjustment of HMT330/PTU300 using a calibrator..... 46
 - 7.3.4 LiCl-NaCl adjustment of HMT330/PTU300..... 47
 - 7.4 Calibrating and adjusting HMT310 series transmitters..... 48
 - 7.4.1 Field checking and adjustment of HMT310 using a calibrated reference probe..... 49
 - 7.4.2 1-point adjustment of HMT310 using a calibrator..... 49
 - 7.4.3 2-point adjustment of HMT310 using a calibrator..... 50
 - 7.4.4 Environment settings for HMT310..... 51
 - 7.5 Checking and adjusting HMP155 probes..... 51
- 8. Calibrating and adjusting HMP70 series probes 53**
 - 8.1 Probe calibration overview..... 53
 - 8.2 LiCl-NaCl automatic RH adjustment of HMP70 series probes..... 53
 - 8.3 2-point RH adjustment of HMP70 series probes..... 53
 - 8.4 1-point RH adjustment of HMP70 series probes..... 55
 - 8.5 Making temperature adjustments..... 55
 - 8.6 1-point T adjustment of HMP70 series probes..... 56
 - 8.7 2-point T adjustment of HMP70 series probes..... 56
- 9. Maintenance 58**
 - 9.1 Changing the filter..... 58
 - 9.2 Error messages..... 58

10. Technical data	60
10.1 HMP75, HMP76, and HMP77 specifications.....	60
10.2 MI70 specifications.....	63
10.3 Dimensions.....	65
10.4 Spare parts and accessories.....	66
Maintenance and calibration services	69
Technical support	69
Warranty	69
Recycling	69

List of figures

Figure 1	HMP75, HMP76, and HMP77 probes (left to right).....	11
Figure 2	MI70 indicator parts.....	13
Figure 3	Measurement error at 100 %RH with 1 °C difference between the ambient and sensor temperature.....	18
Figure 4	Display example with carbon dioxide and temperature and humidity probes connected simultaneously.....	19
Figure 5	HM70 basic display.....	20
Figure 6	HM70 menus.....	22
Figure 7	Environment menu.....	24
Figure 8	Display setting menus.....	25
Figure 9	User interface settings menus.....	27
Figure 10	Hold/Save replaced by Chemical Purge shortcut.....	29
Figure 11	Calibration reminder menu.....	30
Figure 12	Device information menu.....	30
Figure 13	HM70 device information screens.....	31
Figure 14	Recording/Viewing menu.....	32
Figure 15	Selecting analog output.....	35
Figure 16	Response time to high RH/T environment.....	37
Figure 17	HMT310 adjustment button location.....	48
Figure 18	Temperature measurement accuracy over temperature range.....	61
Figure 19	Accuracy of dew point temperature °C.....	61
Figure 20	Accuracy of mixing ratio g/kg (ambient pressure 1013 mbar).....	62
Figure 21	Accuracy of wet bulb temperature °C.....	62
Figure 22	Accuracy of absolute humidity g/m ³	62
Figure 23	MI70 indicator and HMP75 probe dimensions in mm (inches).....	65
Figure 24	HMP76 and HMP77 probe with cable, dimensions in mm (inches)..	66
Figure 25	HMP77 probe dimensions in mm (inches).....	66

List of tables

Table 1	Document versions (English).....	7
Table 2	Related manuals.....	7
Table 3	Display parameters.....	10
Table 4	HMP75, HMP76, and HMP77 probe features.....	12
Table 5	MI70 battery status indicator.....	14
Table 6	MI70 status icons.....	23
Table 7	List of HM70 error messages.....	58
Table 8	HMP75, HMP76, and HMP77 measurement performance.....	60
Table 9	Calculated parameters.....	61
Table 10	HMP75, HMP76, and HMP77 general specifications.....	63
Table 11	HMP75, HMP76, and HMP77 mechanical specifications.....	63
Table 12	MI70 measurement indicator.....	63
Table 13	MI70 battery operation time.....	65
Table 14	HM70 spare parts and accessories.....	67

1. About this document

1.1 Version information

This manual provides information for operating and maintaining Vaisala HUMICAP® Handheld Humidity and Temperature Meter HM70.

Table 1 Document versions (English)

Document code	Date	Description
M210297EN-G	October 2020	<p>This document.</p> <ul style="list-style-type: none"> The following sections added: <ul style="list-style-type: none"> Setting calibration reminder (page 30) Calibrating and adjusting HMT120 and HMT130 series transmitters (page 39) Calibrating and adjusting HMT310 series transmitters (page 48) Checking and adjusting HMP155 probes (page 51) The following sections updated: <ul style="list-style-type: none"> Sections introducing the MI70 indicator Measuring multiple parameters simultaneously (page 18) HM70 in checking and adjusting (page 39) Calibrating and adjusting HMT330 series and PTU300 series transmitters (page 43) 2-point RH adjustment of HMP70 series probes (page 53) (the first note) Spare parts and accessories (page 66) Removed calibration instructions for HMD20/30, HMW20/30, HMD60/70, HMW60/70, DMW19, HMM210, HMP130, HMP230/240 and HMT320 Document format and layout update, quality improvements, and content reorganization
M210297EN-F	October 2007	<p>Previous version. USB connectivity option added, new display languages (Chinese, Japanese, Russian) added.</p>
M210297EN-E	May 2007	<p>Sensor types updated to HUMICAP® 180R and HUMICAP® 180RC.</p>

1.2 Related manuals

Table 2 Related manuals

Document code	Name
M211060EN	<i>Vaisala Humidity and Temperature Probes HMP60 and HMP110 Series User Guide</i>

Document code	Name
M211726EN	<i>Vaisala Humidity and Temperature Transmitter HMDW110 Series User Guide</i>
M211399EN	<i>Vaisala Humidity and Temperature Transmitter HMW90 Series User Guide</i>
M212016EN	<i>Vaisala HMD60 Series Humidity and Temperature Transmitters HMD62 and TMD62 User Guide</i>
M212243EN	<i>Vaisala HMD60 Series Humidity and Temperature Transmitters HMD65 User Guide</i>
M211659EN	<i>Vaisala Humidity and Temperature Transmitter GMW90 Series User Guide</i>

1.3 Documentation conventions



WARNING! Warning alerts you to a serious hazard. If you do not read and follow instructions carefully at this point, there is a risk of injury or even death.



CAUTION! Caution warns you of a potential hazard. If you do not read and follow instructions carefully at this point, the product could be damaged or important data could be lost.



Note highlights important information on using the product.



Tip gives information for using the product more efficiently.



Lists tools needed to perform the task.



Indicates that you need to take some notes during the task.

1.4 Trademarks

Vaisala® and HUMICAP® are registered trademarks of Vaisala Oyj.

Microsoft®, Windows®, and Excel® are either registered trademarks or trademarks of Microsoft Corporation in the United States and/or other countries.

All other product or company names that may be mentioned in this publication are trade names, trademarks, or registered trademarks of their respective owners.

2. Product overview

2.1 Introduction to HM70

Vaisala HUMICAP® Handheld Humidity and Temperature Meter HM70 measures relative humidity and temperature accurately in measurement range $-70 \dots +180 \text{ }^\circ\text{C}$ ($-94 \dots +356 \text{ }^\circ\text{F}$), depending on the probe model. HM70 incorporates the advanced Vaisala HUMICAP® technology that enables reliable and high-performance humidity measurement. HM70 consists of 2 main units: Vaisala Handheld Measurement Indicator MI70 and the HMP75/HMP76/HMP77 probe.

HM70 can be used to measure the following parameters:

Table 3 Display parameters

Parameter	Abbreviation	Metric unit	Non-metric unit
Relative humidity	RH	%RH	%RH
Temperature	T	$^\circ\text{C}$	$^\circ\text{F}$
Dew point/frost point temperature ¹⁾	$T_{d/f}$	$^\circ\text{C}$	$^\circ\text{F}$
Dew point temperature ²⁾	T_d	$^\circ\text{C}$	$^\circ\text{F}$
Absolute humidity	a	g/m^3	gr/ft^3
Mixing ratio	x	g/kg	gr/lb
Wet bulb temperature	T_w	$^\circ\text{C}$	$^\circ\text{F}$
Humid air volume/dry air volume	H_2O	ppm	ppm
Water vapor pressure	pw	hPa	lb/in^2
Saturation water vapor pressure	pws	hPa	lb/in^2
Enthalpy	h	kJ/kg	Btu/lb
Water activity	a_w	aw	aw

- 1) $T_{d/f}$ shows dew point temperature above the freezing point ($0 \text{ }^\circ\text{C}/32 \text{ }^\circ\text{F}$) and frost point temperature T_f (dew point over ice) below the freezing point.
- 2) T_d shows dew point over water throughout the entire measurement range.

More information

- [Overview of probes \(page 11\)](#)
- [MI70 indicator parts \(page 13\)](#)
- [HMP75, HMP76, and HMP77 specifications \(page 60\)](#)
- [MI70 specifications \(page 63\)](#)

2.1.1 Basic features and options

HM70 has the following basic features and options:

- Displays various humidity parameters
- Numerical and graphical multilingual displays
- Data recording possibility
- Three probes, temperature measurement range $-70 \dots +180 \text{ }^{\circ}\text{C}$ ($-94 \dots +356 \text{ }^{\circ}\text{F}$), depending on probe model
- Sensor preheat and chemical purge options for demanding conditions
- Multiprobe operation; any combination of 2 Vaisala DM70, GM70, HM70, and MM70 series probes can be used, for example, for simultaneous humidity and CO_2 measurements
- The optional, ready-to-use MI70 Link Microsoft Windows® software, which allows an easy way to handle measurement data using a serial line or a USB instrument cable
- Delivered with a factory calibration certificate

2.1.2 Overview of probes

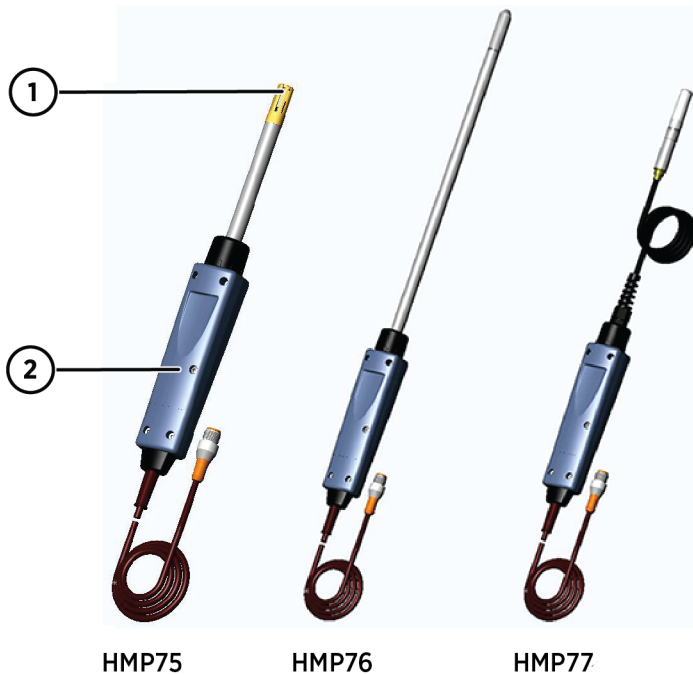

Figure 1 HMP75, HMP76, and HMP77 probes (left to right)

- 1 Probe filter
- 2 Calibration mode activation button under the screw in the probe handle

Table 4 HMP75, HMP76, and HMP77 probe features

Probe model	Overview
HMP75	Basic probe for relative humidity and temperature measurement. Preheat and chemical purge options available with model HMP75B.
HMP76	Rugged probe with a long stainless steel shaft. Preheat and chemical purge options available with model HMP76B.
HMP77	Cable probe for industrial processes up to +180 °C (+356 °F). Preheat and chemical purge options available with model HMP77B.

3. MI70 indicator

3.1 MI70 indicator parts

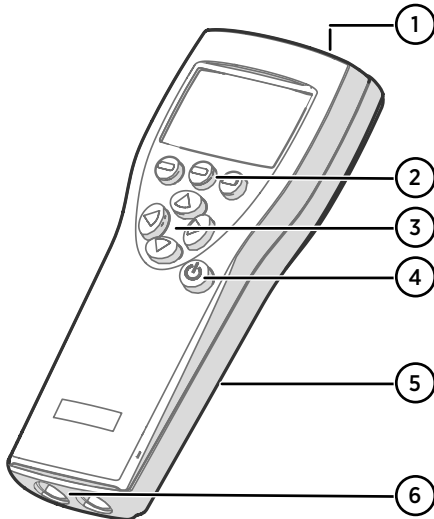







Figure 2 MI70 indicator parts

- 1 Charger socket
- 2 Function key shortcut buttons . The functions change according to what you are doing with the indicator.
- 3 Arrow buttons:
 -  Move up in a menu
 -  Move down in a menu
 -  Enter a sub-menu
 -  Return to previous menu level
- 4 Power On/Off button
- 5 Battery compartment at the back of the indicator
- 6 2 ports (labeled I and II) for connecting probes and instruments.

To open menus, press an arrow button and then press the shortcut buttons. To activate a function shown above the shortcut button, press the shortcut button. To navigate in the menus, press the arrow buttons.

3.2 Installing and recharging MI70 batteries

If you are using **alkaline** batteries, unscrew the back plate of the indicator and insert the batteries. Do not attempt to recharge standard alkaline batteries.

If you ordered MI70 with a **rechargeable** battery, it is already in place as shipped from the factory. The delivered batteries have been pre-charged.

To recharge the battery:

- ▶ 1. Plug in the charger connector to the indicator. The socket is located at the top of the indicator, covered by a rubber seal.

2. Connect the charger to a wall socket. An animated battery icon in the left corner of the display indicates that the battery is charging. The recharge duration (typically 4 ... 5 h) depends on the charge level of the battery.

 A new battery takes approximately 3 charging cycles to reach its maximum battery life.

 Do not store the batteries empty. Empty batteries may not charge after an extended storage period.



More information

- [Changing the rechargeable battery pack \(page 15\)](#)

3.2.1 MI70 battery status information

The status of the MI70 battery is shown by the battery icon in the upper left corner of the display. Possible statuses are listed in the following table.

Table 5 MI70 battery status indicator

Battery status indicator graphic	Description
	<p>Battery status icon. The icon can show the following info:</p> <ul style="list-style-type: none"> • 0 ... 8 bars, no animation: <ul style="list-style-type: none"> • batteries are in use, a charger is not connected • if a charger is connected: non-rechargeable batteries installed • if a charger is connected: waiting for the battery temperature to settle between 0 ... +40 °C (+32 ... +104 °F) • if a charger is connected and the icon remains at 8/8 bars: the battery is full • Animated battery status icon: battery is charging (or recovering after emptying out completely). The charging animation is shown also when the indicator is powered off. • Battery icon not present: batteries are not installed
	<p>An empty battery icon with an X over it means that the battery cannot be recharged and must be replaced. If the indicator is powered on, a notification about not being able to charge the battery is shown on the MI70 screen.</p> <p>You can order replacement batteries from Vaisala (item code 26755).</p>



To keep the rechargeable MI70 battery in good working condition, recharge MI70 monthly if the indicator is not in use.

3.3 MI70 first start-up settings

When you switch on MI70 for the first time, configure the basic settings (time, date, language) as instructed below.

- ▶ 1. Press the **Power On/Off** button.
2. Press any of the arrow buttons and open the menu by pressing **Open**.
3. Select **Settings** using the buttons and press .
4. Select **User interface** and press .
5. Select **Language** and press **Set**.
6. Select the language using the buttons. Confirm the selection by pressing **Select**.
7. If you want to set the date at this point, return to the **Settings** menu by pressing .



The language can be selected also later. For instructions, see [Selecting language \(page 27\)](#).

8. To change the date, select **Date** and press **Set**. Then change the date using the buttons. To confirm the selection, press **Select**. As a default, the date format is year-month-day. You can select from 2 other alternative formats.
9. To change the time, select **Time** and press **Set**. Then change the time by using the arrow buttons. Confirm the selection by pressing **OK**. As a default, the time format is based on the 24-hour clock. If you want to use the 12-hour clock, select **12-hour clock** and then press **On**.
10. To return to the basic display, press **Exit**.

3.4 Changing the rechargeable battery pack



- New rechargeable battery pack
- Medium-sized flathead screwdriver

In case you are installing a battery pack and you have a device with alkaline batteries, remove the metal contact from the probe port end of the battery compartment before installing the battery pack.

- ▶ 1. Open the back plate of the indicator by opening the screw of the back plate.
2. Remove the old battery pack. Detach the black connector by carefully pulling it up from the wires.
3. Connect the black connector of the new battery pack. Make sure the position of the connector is as shown in the following figure (red and black wires are on the upper edge of the connector). Do not push the connector with conducting material.

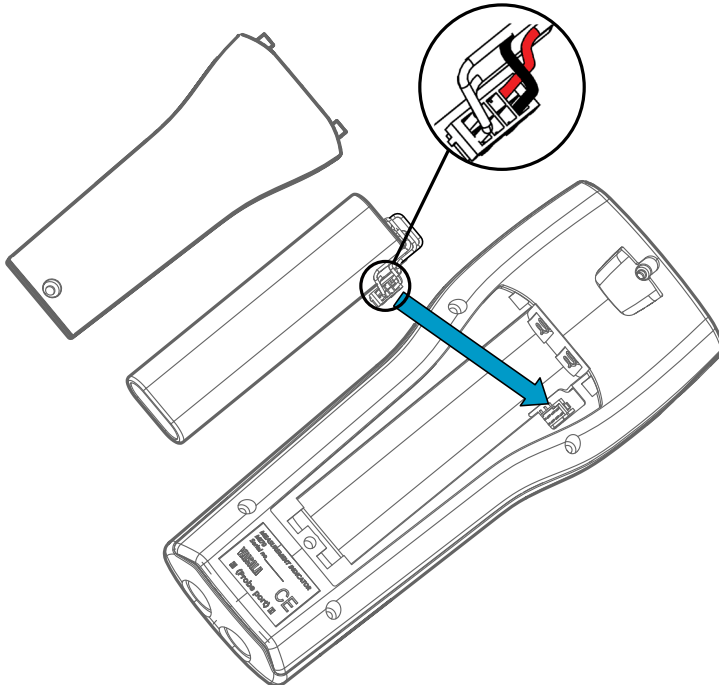

4. Place the battery pack in the compartment.
5. Close the back plate and tighten the screw.
6. Recharge the indicator before use.

More information

- ▶ [Installing and recharging MI70 batteries \(page 13\)](#)

4. Taking measurements

4.1 Basic measuring steps



Before measurements, ensure that the air pressure setting of HM70 is correct: see [Setting actual pressure value and unit \(page 24\)](#).



For information on starting to use the MI70 indicator, see [MI70 first start-up settings \(page 15\)](#).

- ▶ 1. Connect the probe cable to the MI70 indicator's connector port.
- 2. Switch the MI70 indicator on by pressing the **Power On/Off** button.
- 3. If your probe includes the chemical purge option (available in HM70 series probe versions B), remember to carry out chemical purge regularly: see [Chemical purge \(optional\) \(page 36\)](#).
- 4. In case there is a risk of condensation, use the optional preheat (HM70 series probe versions B) when installing the probe: see [Sensor preheat \(optional\) \(page 36\)](#).
- 5. Install the probe to the measuring position.
- 6. The basic display opens. Let the measurement reading stabilize.



CAUTION! Handle the probe carefully. Strong impact or falling can damage the probe.



If you need to disconnect the probe, first press the **Power On/Off** button to switch the indicator off. This ensures that all settings and data are saved properly.

4.2 Errors caused by temperature differences

In humidity measurement and especially in calibration, it is essential that the temperature of the probe and the measurement environment are the same. Even a small temperature difference between the environment and the probe causes an error. As the curve in the following figure shows, if the temperature is +20 °C and relative humidity is 100 %RH, a difference of ± 1 °C between the environment and the probe causes an error of ± 6 %RH. When the humidity is 90 %RH, the corresponding error is ± 5.4 %RH.

A temperature difference of a few degrees can also cause water to condense on the sensor surface. The HUMICAP® sensor starts to function normally as soon as the water has evaporated. If the condensed water is contaminated, the life span of the probe may shorten and calibration may change.

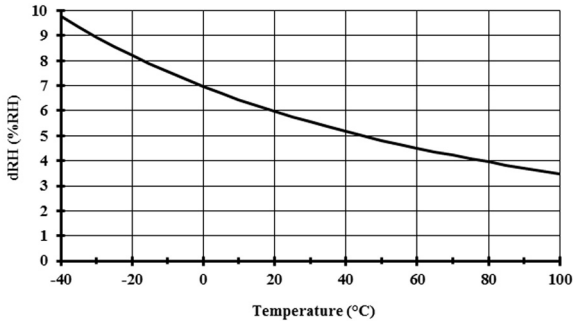

Figure 3 Measurement error at 100 %RH with 1 °C difference between the ambient and sensor temperature

More information

- [Sensor preheat \(optional\) \(page 36\)](#)

4.3 Measuring multiple parameters simultaneously

MI70 is a generic indicator that can be used with Vaisala interchangeable dew point (DM70 series), humidity (HM70 series), carbon dioxide (GM70 series), and moisture in oil (MM70 series) probes. Two different types of probes can be connected to MI70 simultaneously.

1. Switch off the MI70 indicator.
2. Connect the 2 probes to the connector ports (port I and II) on the bottom of the indicator.
3. Switch on MI70.
4. Check that the environment settings of the probes in port I and II are the same if you are taking measurements from the same condition. In this case, select **Yes** when MI70 prompts you to check the environment settings.
5. When measuring humidity and CO₂ simultaneously, you can use the HMP70 probe's temperature data to compensate the CO₂ measurement.
 - a. Select temperature (**T**) and press **Set**.
 - b. MI70 asks if you want to link the measured T value to environment parameter: to link, press **Link** and then press **Exit**.

6. The reading of the probe in port I is now displayed on the upper row(s) and the reading of the probe in port II on the lower row(s) of the MI70 display.

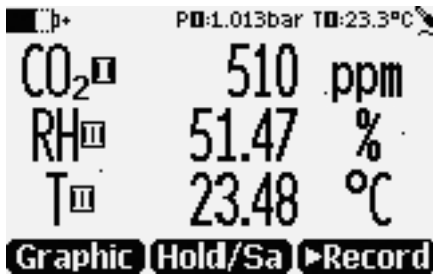

Figure 4 Display example with carbon dioxide and temperature and humidity probes connected simultaneously

5. Displays and menus

5.1 Basic display



In the MI70 user interface, measurement parameters are referred to as quantities.

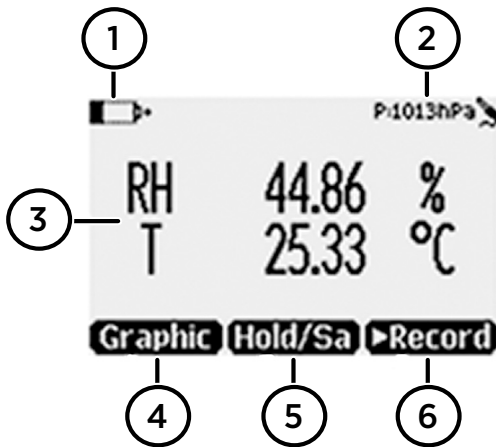

Figure 5 HM70 basic display

- 1 Battery indicator. Shows the current status (charge) of the battery.
- 2 Pressure setting.
- 3 Measured parameter (up to 3 items on display simultaneously). You can change the shown items in **Main menu > Display > Quantities and units**. For a list of available parameters ("quantities"), see [Table 3 \(page 10\)](#).
- 4 Function key **Graphic** shows the readings as a curve.
- 5 Function key **Hold/Save** freezes the display and you can save the reading in the MI70 memory.
- 6 Function key **Record** gives quick access to the **Recording/Viewing** menu.

You can change the default function key shortcuts (**Graphic**, **Hold/Save**, **Record**) to other menus or functions in **Main menu > Settings > User interface > Program shortcut keys**.

More information

- [Programming shortcut keys \(page 28\)](#)

5.2 Graphical display

The graphical display shows you the measurements as a curve (the curve of the uppermost parameter shown in the basic display). From the curve you can examine the data trend and history of the last minutes.

To open the graphical display, select **Graphic** in the basic display or select **Main menu > Display > Graphic history > Show**.

To get the statistical info on the graph area (minimum, maximum, and average values), press **Info**.

To get the curve of the other selected parameters, press **Next**. To get the curves of all the parameters, press **Next** until the text **All** appears, and then select **All**.





To zoom in and out, press the up/down arrow buttons.

To move back and forward in the timeline, use the left/right arrow buttons.

5.3 Main menu

In the main menu, you can configure the MI70 settings and basic display options, view information about the probe, access recordings and clear the memory, set alarms, start adjustments, and use the analog output option of the MI70 indicator.

To open the main menu and navigate in the menus:

- ▶ 1. Go to the basic display.
2. Press any arrow button, then select  **Open** (must be pressed within 5 seconds or the indicator returns to the basic display).
3. Move in the menus using the   buttons.
4. Select an item with the  button.
5. To return to the previous level, press .

6. To return to normal operation, press  **Exit**.



Main menu



Display menu



Functions menu



Recording/Viewing menu

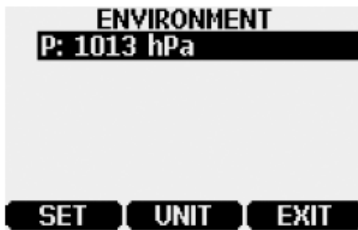

Environment menu











Settings menu

Figure 6 HM70 menus

5.4 MI70 status icons

Icons that inform you about the status of MI70 (for example, battery status and alarm notification) are shown on the upper left corner of the display. Multiple icons can be shown simultaneously.

Table 6 MI70 status icons

Icon	Description
 	<p>Battery status icon. The icon can show the following info:</p> <ul style="list-style-type: none"> • 0 ... 8 bars, no animation: <ul style="list-style-type: none"> • batteries are in use, a charger is not connected • if a charger is connected: non-rechargeable batteries installed • if a charger is connected: waiting for the battery temperature to settle between 0 ... +40 °C (+32 ... +104 °F) • if a charger is connected and the icon remains at 8/8 bars: the battery is full • Animated battery status icon: battery is charging (or recovering after emptying out completely). The charging animation is shown also when the indicator is powered off. • Battery icon not present: batteries are not installed
	<p>The battery can no longer be charged and must be replaced.</p>
	<p>Recording icon. Shows that the measurements are being recorded. The bar shows for how long the recording will continue (a set time limit or until the memory runs out). The recording icon and bar are shown also when the indicator is powered off.</p>
	<p>Calibration reminder icon. Appears when a calibration reminder has been set to inform that a user-defined interval has passed and calibration is due.</p>
	<p>Analog output icon. Shown when the analog output mode is in use.</p>
	<p>PC connection icon. Shown when the indicator is connected to a PC with a cable.</p>
	<p>Alarm icon. Shown when the measurement has reached a user-defined alarm limit.</p>

More information

- [Recording data \(page 32\)](#)
- [MI70 battery status information \(page 14\)](#)
- [Setting calibration reminder \(page 30\)](#)
- [Transferring recorded data to PC with MI70 Link \(page 33\)](#)
- [Setting an alarm \(page 34\)](#)
- [Selecting and scaling analog output \(page 35\)](#)

6. Settings

6.1 Setting actual pressure value and unit



Figure 7 Environment menu

When measuring in pressurized environments, the actual process pressure value must be given to the HM70. The pressure can be given in the following units:

- **hPa**: Absolute pressure given in the unit of hPa.
- **barg**: Gauge pressure given in the unit of bar. Indicates the pressure difference between normal atmospheric pressure and the actual process pressure.
- **bara**: Absolute process pressure given in the unit of bar.
- **psia**: Absolute pressure given in the unit of psi.

- ▶ 1. Open the menu by pressing **Open**.
2. Select **Environment** and press .
3. Press **Unit** to change the pressure unit. Default unit is hPa.
4. Press **Set** to set the ambient pressure value.
5. Set the pressure value with the arrow buttons. Press **+/-** to change the sign of the pressure value. Press **OK** to save the value.
6. To return to the basic display, press **Exit**.

6.2 Display settings

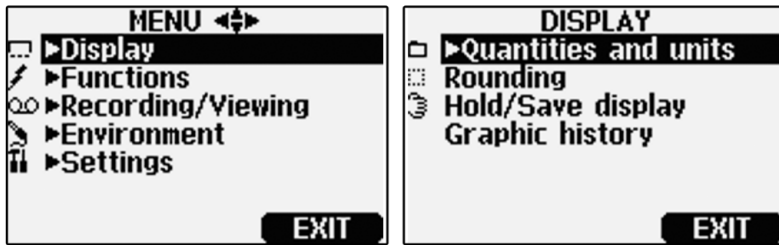

Figure 8 Display setting menus

6.2.1 Selecting parameters and units



In the MI70 user interface, measurement parameters are referred to as quantities.

- ▶ 1. Open the menu by pressing **Open**.
2. Select **Display** and press .
3. Select **Quantities and units** and then press .
4. To select a parameter, move on the desired parameter using the arrow buttons and then press **Select**.
5. To change the unit, move on the desired parameter using the arrow buttons and then press **Unit**.
6. To hide a parameter, move on the desired parameter using the arrow buttons and then press **Hide**.
7. To return to the basic display, press **Exit**.
8. If you want to check the environment settings, press **Yes**. Otherwise press **No**.

6.2.2 Rounding

- ▶ 1. Open the menu by pressing **Open**.
2. Select **Display** and then press .
3. Select **Rounding**.

- 4. To return to the basic display, press  **Exit**.

 Rounding does not affect the measurement accuracy defined in the device specifications.

6.2.3 Holding and saving the display

With the **Hold/Save** function, you can freeze a certain display reading. This reading can be saved in the MI70 memory and it will be available even after MI70 is disconnected from the transmitter.

- ▶ 1. In the basic display, select **Hold/Save**. Alternatively, select **Main menu > Display > Hold/Save display > Hold**.
- 2. Press **Save**.
- 3. To view the saved display, go to basic display and select **Record > View recorded data**. Alternatively, select **Main menu > Recording/Viewing > View recorded data**.
A list of saved displays and data recordings appears. The icons on the left of the date and time indicate whether the file is a saved display or a longer recording of data:



Saved display

Data recording

- 4. Select the saved display based on date and time by pressing the right arrow button.



6.3 User interface settings

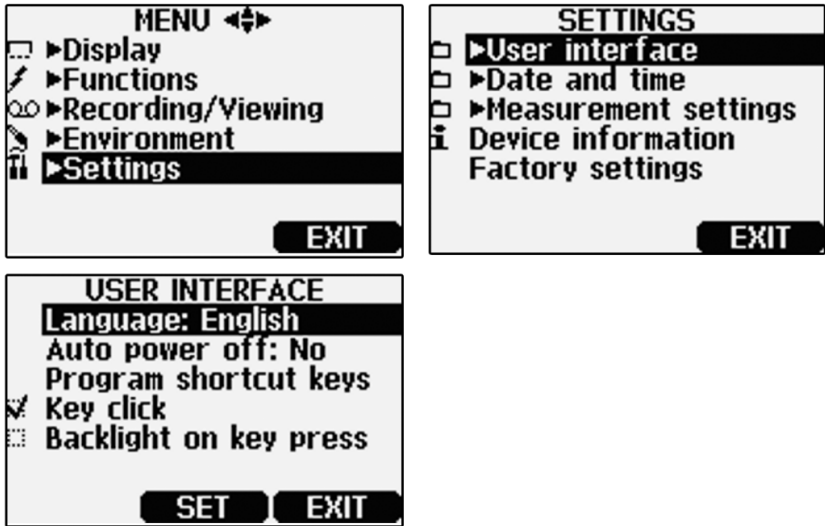

Figure 9 User interface settings menus







6.3.1 Selecting language

You can select any of the following languages for the user interface: English, Finnish, Chinese, Russian, Japanese, Swedish, French, German, or Spanish.

- ▶ 1. Open the menu by pressing **▶◀ Open**.
2. Select **Settings** and then press **▶**.
3. Select **User interface** and then press **▶**.
4. Select **Language** and press **◀ Set**.
5. Choose the correct language and press **◀ Select**.
6. To return to the basic display, press **◀ Exit**.







6.3.2 Correcting language selection

- ▶ 1. Return to the basic display by pressing the rightmost **◀** button until the basic display appears.







2. Go to the **Language selection menu** by pressing first  and then the  button in the middle.
3. Then press , then , then  again, and finally press the  button in the middle.
4. Reselect the language.

6.3.3 Configuring automatic power off

As a default, MI70 powers off after 15 minutes of inactivity. This also saves battery. The inactivity setting can be changed to 60 minutes or completely turned off.

- ▶ 1. Open the menu by pressing   **Open**.
- 2. Select **Settings** and press .
- 3. Select **User interface** and press .
- 4. Select **Auto power off** and press  **Set**.
- 5. Choose an inactivity time option and press  **Select**.
- 6. To return to the basic display, press  **Exit**.

6.3.4 Programming shortcut keys

- ▶ 1. Open the menu by pressing   **Open**.
- 2. Select **Settings** and press .
- 3. Select **User interface** and press .
- 4. Select **Program shortcut keys** and press  **Start**.
- 5. Press the shortcut key you want to change, for example, **Hold/Save**.
- 6. If you want to replace **Hold/Save** with the chemical purge function, select **Functions > Chemical Purge** with the arrow buttons and then press  **Select**. To confirm your selection, press **Yes**. Otherwise press **No** and continue from step 4.







- To return to the basic display, press  **Exit**.



Figure 10 Hold/Save replaced by Chemical Purge shortcut

6.3.5 Configuring button tones and backlight







To turn on or off the backlight or the sound effects for the buttons:

- Open the menu by pressing   **Open**.
- Select **Settings** and press .
- Select **User interface** and press .
- To turn the sound effect on or off, select **Key Click** and press .
- To turn the backlight on or off, select **Backlight on key press** and press .
- To return to the basic display, press  **Exit**.

6.4 Date and time

As a default, the time format is based on the 24-hour clock. Also a 12-hour clock can be used.

The default date format is day.month.year, for example, 25.4.2020. The date format can be changed to month.day.year. or year.month.day.

- Open the menu by pressing   **Open**.
- Select **Settings** and press .
- Select **Date and time** and press .
- For the desired date, select **Date** and then press  **Set**. Use the arrow buttons to change the date. Confirm the selection by pressing  **Select**. To change the date format, select an option and press  **Select**.

- For the desired time, select **Time** and press **Set**. Use the arrow buttons to change the time. To confirm the selection, press **OK**. To change the time format, select **12-hour clock** and press **On/Off**.
- To return to the basic display, press **Exit**.

6.5 Setting calibration reminder

You can set a calibration reminder to notify when calibration is due. Choose an interval of 3, 6, 12, or 24 months. By default, the reminder is off.

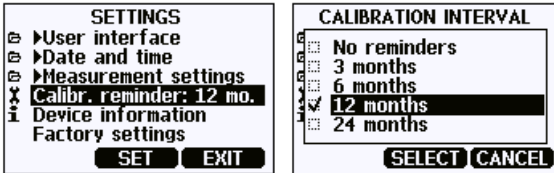

Figure 11 Calibration reminder menu



Make sure the M170 date and time settings are correct when using the calibration reminder.

- Open the menu by pressing **Open**.
- Select **Settings** and press **Open**.
- Select **Calibr. reminder** and press **Set**.
- Choose a reminder interval option and press **Select**.
- To return to the basic display, press **Exit**.

6.6 Device information

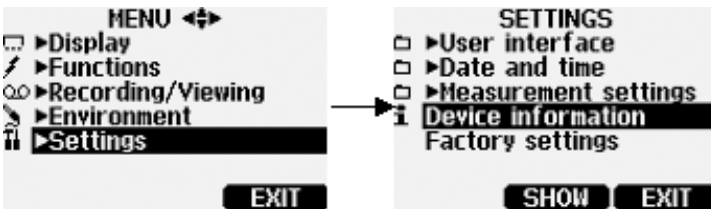







Figure 12 Device information menu

To view basic information about the indicator and probe:

- ▶ 1. Open the menu by pressing   **Open**.
2. Select **Settings** and press .
3. Select **Device information** and press  **Show**.
4. The first display gives information on the MI70 indicator. For details on the probe, press  **More**.
5. To return to the basic display, press  **Exit**.

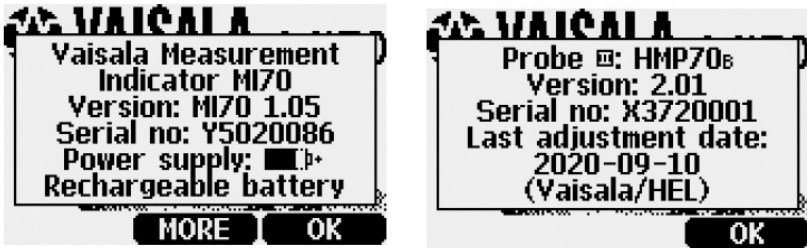







Figure 13 HM70 device information screens

6.7 Factory settings

Factory settings can be restored to clear all the changed settings and data memory of the indicator. Restoring factory settings does not affect the probe calibration.

- ▶ 1. Open the menu by pressing   **Open**.
2. Select **Settings** and press .
3. Select **Factory Settings** and press  **Revert**. To confirm the selection, press  **Yes**. MI70 powers off automatically.



When MI70 is switched on after a factory reset, the language, date, and time settings must be set again.

More information

- ▶ [Selecting language \(page 27\)](#)
- ▶ [Date and time \(page 29\)](#)

6.8 Recording and viewing data

6.8.1 Recording data

With MI70, you can record transmitter measurement data over a certain period at chosen intervals. These recordings are saved in the MI70 memory and are available even after MI70 is disconnected from the transmitter. To start recording, select the **Record** function key in the basic display, or navigate to the recording menu: **Main menu > Recording/Viewing > Record data**.

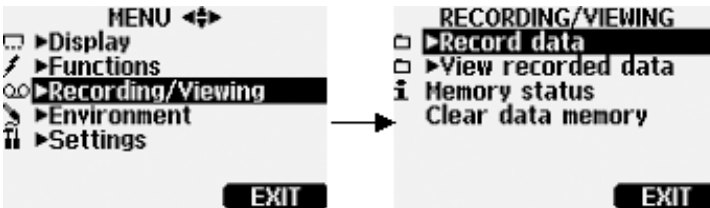

Figure 14 Recording/Viewing menu

6.8.2 Viewing recorded data

- ▶ 1. Open the menu by pressing **▶** **Open**.
2. Select **Recording/Viewing** and press **◀**.
3. Select **View recorded data** and press **▶**.
4. Select the file you want to view and press **▶**. The files are identified according to the starting date and time of recording.
5. To go to the graphical view, press **◀ Graph**. To view the recording time stamps, press **◀ Times**. To return to the recording values, press **◀ Values**.
6. To return to the basic display, press **◀ Exit**.

6.8.3 Checking MI70 memory status

- ▶ 1. Open the menu by pressing **▶** **Open**.
2. Select **Recording/Viewing** and press **▶**.
3. To view the amount of memory that is in use and the estimated free space left, select **Memory status** and press **◀ Show**.

- To return to the basic display, press **OK** and **Exit**.



The estimate of available free space is calculated for the current number of active parameters. If you change the displayed parameters, the estimate will change accordingly.

6.8.4 Clearing data memory

- Open the menu by pressing **Open**.
- Select **Recording/Viewing** and press .
- Select **Clear data memory** and press **Clear**. To confirm the deletion, press **Yes**.
- To return to the basic display, press **Exit**.

6.8.5 Transferring recorded data to PC with MI70 Link

PC data transfer requires the MI70 Link Windows® software and a Vaisala USB cable (item code 219687). The serial connection cable can also be used for MI70 Link data transfer. The MI70 Link software is available from the Vaisala website: www.vaisala.com/mi70link.

Recorded data can be transferred to a PC using the MI70 Link program that allows examining the recorded data easily in the Microsoft Windows® environment and processing it further on a spreadsheet program such as Microsoft Excel®. Both logged and real-time measurement data can be transferred.

To set up an MI70 Link connection:

- Install the MI70 Link software according to the instructions on the installation wizard. Do not connect the USB cable before the installation has completed.
- After the installation completes, connect the MI70 indicator to the PC with the USB/serial cable. Windows detects the new device automatically.
- You can now access the readings from the PC with MI70 Link. If MI70 Link cannot discover the instrument, check the following:
 - the device is powered on
 - the cable is properly connected
 - another application has not reserved the connection

6.9 Other functions

6.9.1 Setting an alarm



In the MI70 user interface, measurement parameters are referred to as quantities.

When an alarm is triggered, the indicator beeps and the display backlight blinks. The alarm is triggered when the measured value is not between the alarm limits, that is, the permitted area. The alarm level(s) can be set for only 1 parameter at a time.

- ▶ 1. Open the menus by pressing **Open**.
2. Select **Functions** and press .
3. Select **Alarm** and press .
4. Select **Quantity** and press **Set** to select the parameter.
5. Select the parameter and press **Select**. Only 1 active parameter can be selected at a time. To change which parameters are active, go to **Menu > Display > Quantities and units**.
6. Select the first limit and and press **Set** (if the alarm function is on, turn it off). Use the arrow buttons to set the alarm level. To select the sign for the alarm level, press the +/- button. To save the settings, press **OK**.
7. Select the second limit and follow the instructions in [step 6](#). The alarm is triggered when either the upper or lower limit is exceeded.
If you have only 1 limit, for example, if you want to detect if the humidity is rising above 50 %RH, set the upper limit to 50 %RH and the lower limit so low that it will never be reached (for example 0 %RH). With this configuration, HM70 alerts when %RH rises above 50 %RH.
8. To activate the alarm and to return to the basic display, select **Alarm On/Off** and press **On**. The note icon appears in the upper left corner of the display.
9. When the alarm level is reached, you can stop the alarm by pressing **OK**. To reactivate the alarm, press **Yes**. To discard the alarm, press **No**.



The alarm does not work when the device is powered off.

More information

- ▶ [Configuring automatic power off \(page 28\)](#)

6.9.2 Selecting and scaling analog output

To get analog measurement data, an analog signal cable is needed (Vaisala item code 27168ZZ).

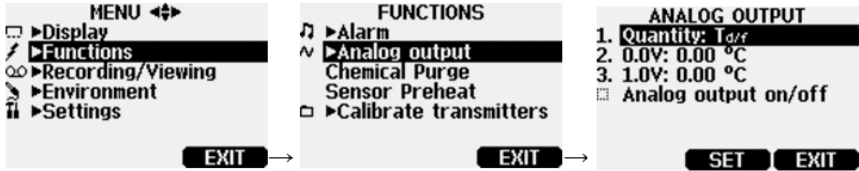

Figure 15 Selecting analog output

- ▶ 1. Connect the signal cable connector of the analog output to the base connector of the MI70 indicator. Connect the screw terminal block as follows:

Wire	Connect to
Brown wire	Common wire (-)
Yellow-green wire	Signal (+)

2. Open the menu by pressing **Open**.
3. Select **Functions** and press .
4. Select **Analog output** and press .
5. To set the value for the 0.0 V output signal, select **0.0 V** and press **Set**. If the analog output is on, turn it off. Set the low value using the arrow buttons. To select the sign for the value, press +/- . To confirm the setting, press **OK**.
6. To set the value for the 1.0 V output signal, select **1.0 V** and press **Set**. Set the high value using the arrow buttons. To select the sign for the value, press +/- . To confirm the setting, press **OK**.
7. To activate the analog output and to return to the basic display, select **Analog output on/off** and **On**. The wave icon appears in the upper left corner of the basic display.
8. To deactivate analog output, go to **Menu > Functions > Analog output - Analog output on/off** and press **Off**.

6.9.3 Chemical purge (optional)







Chemical purge is an optional feature of the HM70 series humidity probes HMP75B, HMP76B, and HMP77B. In some specific applications the sensor gain may decrease gradually due to an interference caused by some particular chemical present in the ambient. The sensor polymer absorbs the interfering chemical; this reduces the polymer's ability to absorb water molecules and so decreases the sensor sensitivity. In chemical purge the interfering chemical is evaporated by heating the humidity sensor to a temperature of +160 °C (+140 °F) for 2 minutes.

For most applications it is sufficient to perform the chemical purge once a week. For applications where HM70 is subject to high concentrations of chemicals, chemical purge should be performed more frequently, in extreme cases before each measurement.

6.9.3.1 Turning chemical purge ON



This procedure applies only to humidity probes HMP75B, HMP76B, and HMP77B.

- ▶ 1. Open the menu by pressing   **Open**.
2. Select **Functions** and press .
3. Select **Chemical Purge** and press  **Start**.
4. Confirm the purge by pressing  **Yes**. Chemical purge takes up to 6 minutes. During that time there are no readings on the display. A message appears every 15 seconds showing the time required to complete the chemical purge. The chemical purge icon  is shown on the upper left corner.
5. When the chemical purge is complete the basic display with readings returns.
6. It may take a few minutes for the temperature reading to stabilize.



You can create a shortcut to the chemical purge function by setting a shortcut key to point to it. See [Programming shortcut keys \(page 28\)](#).

6.9.4 Sensor preheat (optional)

Sensor preheat is an optional feature of the HM70 series humidity probes HMP75B, HMP76B, and HMP77B.

In some measurement applications, unwanted dew formation makes humidity measurement difficult or even impossible. High humidity combined with rapidly changing outdoor temperature may condense the water vapor in the air onto the sensor. Until this dew evaporates or dries, it is impossible to obtain a correct reading. In sensor preheat the sensor is heated to a temperature level of approximately +100 °C (+212 °F) for up to 4 minutes. This is to prevent possible condensation from the sensor affecting the reading.

When setting the probe from outdoor conditions into warm and humid conditions there may be a large temperature difference between the probe and the external environment. In such conditions, turn on sensor preheat immediately before installing the probe to prevent condensation forming on the probe.

Figure 16 (page 37) shows how the response time can be dramatically shortened and water condensation on the sensor avoided when using sensor preheat.

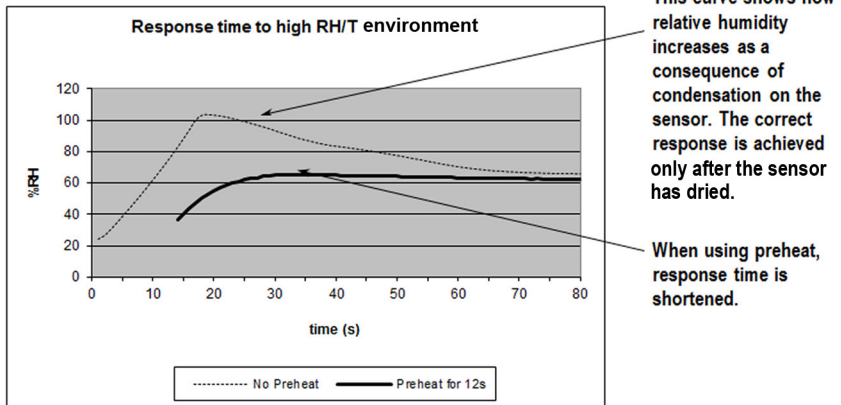

Figure 16 Response time to high RH/T environment

6.9.4.1 Turning sensor preheat ON/OFF



This procedure applies only to humidity probes HMP75B, HMP76B, and HMP77B.

- ▶ 1. Open the menu by pressing **Open**.
2. Select **Functions** and press .
3. Select **Sensor Preheat** and press **Start**. Confirm by pressing **Yes**.
4. Insert the probe to the process.
5. Sensor preheating takes up to 4 minutes. During that time there are no readings on the display. A message appears every 15 seconds showing the time required to complete sensor preheating. The sensor preheat icon is shown on the upper left corner.
6. When sensor preheating is complete, a message is shown and the basic display with readings returns.

7. It may take a few minutes for the temperature reading to stabilize.



You can create a shortcut to the sensor preheat function by setting a shortcut key to point to it. See [Programming shortcut keys \(page 28\)](#).

7. Calibrating and adjusting transmitters

7.1 HM70 in checking and adjusting

The following transmitters and probes can be calibrated by using HM70:

- HMP60 and HMP110 series
- HMDW110 series
- HMW90 series
- GMW90 series
- HMD60 series
- HMT120 and HMT130
- HMT330 series
- HMT310 series
- PTU300 series
- HMP155

When calibrating in the field, check and adjust a fixed transmitter's reading against a calibrated HMP70 series reference probe.

1- or 2-point calibrations can be done to most Vaisala industrial transmitters by using an MI70 indicator and Vaisala Humidity Calibrator HMK15.



For instructions on calibrating and adjusting HMP60/HMP110, HMDW110, HMW90, GMW90, and HMD60 series transmitters, see the respective User Guides, listed in [Related manuals \(page 7\)](#).

7.1.1 Calibration cables

For calibration and adjustment, connect HM70 to a fixed transmitter by using 1 of the following connection cables:

- Cable 211339 for HMT330 series, PTU300 series, and HMT120/HMT130 transmitters
- Cable DRW216050SP for HMT310 series transmitters
- Cable 221801 for HMP155 probes
- Cable 219980 for HMD60 series, HMP60 and HMP110 series, HMW90 series, HMDW110 series, and GMW90 series transmitters

More information

- [Spare parts and accessories \(page 66\)](#)

7.2 Calibrating and adjusting HMT120 and HMT130 series transmitters

You can check and adjust HMT120 and HMT130 relative humidity measurement with HM70. An HM70 connection cable is needed (Vaisala item code 211339).

There are 4 types of adjustments available: field checking and adjustment using a calibrated reference probe, 1-point adjustment using a calibrator, 2-point adjustment using a calibrator, and LiCl-NaCl adjustment.



First carry out [step 1 ... step 7](#). After [step 7](#), choose 1 of the alternative methods for completing the adjustment.

To begin the adjustment:

- ▶ 1. Connect connection cable 211339 to the **SERVICEPORT** connector on the HMT120/HMT130 component board.
2. Connect the other end of the connection cable to either one of the connector ports located on the bottom of the MI70 indicator. See [Figure 2 \(page 13\)](#).
3. Switch on both devices (or only the MI70 in case HMT120/HMT130 is on continuously).
4. The reading of the transmitter is shown on the top or middle row of the MI70 indicator display, depending on which connector port the connection cable is connected to.
5. Press the **ADJ** button on the HMT120/HMT130 component board to open the adjustment mode. The LEDs on the component board remain in OFF state, and a notification about starting the adjustment mode is shown on the MI70 display. If the HMT120/HMT130 transmitter has the optional display, the text **MI70 adjustment mode** is shown on the upper row of the display.



CAUTION! From this point onwards, the local adjustment buttons of HMT120/HMT130 are disabled and the adjustment is carried out using the MI70 indicator. Take care not to press the MI70 buttons too quickly during calibration, or the calibration may fail. Wait for 1 second between button presses. HMT120/HMT130 display and analog outputs always follow the actual measured RH/T value when in MI70 adjustment mode.

6. Press **⏪ OK** to start the adjustment.
7. Check the environment settings if needed. Otherwise press **⏪ NO**. Complete the adjustment using 1 of the following alternative methods:
 - [Field checking and adjustment of HMT120/HMT130 using a calibrated reference probe \(page 41\)](#)
 - [1-point adjustment of HMT120/HMT130 using a calibrator \(page 41\)](#)
 - [2-point adjustment of HMT120/HMT130 using a calibrator \(page 42\)](#)
 - [LiCl-NaCl adjustment of HMT120/HMT130 \(page 43\)](#)

7.2.1 Field checking and adjustment of HMT120/HMT130 using a calibrated reference probe



This procedure is 1 of the alternative methods for completing the adjustment described in [Calibrating and adjusting HMT120 and HMT130 series transmitters \(page 39\)](#).

To complete the adjustment:

- ▶ 1. Check that the probes are located in equal conditions and wait until the readings have stabilized (this may take 30 minutes or longer). If you are near the probes, do not breath in their direction.
2. Press **← Adjust** to continue adjusting.
3. Choose **To same as RH_{I/II}** from the MI70 adjustment menu and press **← Select** (MI70 automatically recognizes which port the HMP70 series probe is connected to).
4. Confirm the adjustment by pressing **← Yes**.
5. The adjustment is done. Press **← Back** and **← Exit** to return to the basic display.
6. Switch off MI70 and detach the connection cable.

7.2.2 1-point adjustment of HMT120/HMT130 using a calibrator





This procedure is 1 of the alternative methods for completing the adjustment described in [Calibrating and adjusting HMT120 and HMT130 series transmitters \(page 39\)](#).



When adjusting the transmitter in only 1 reference condition (that is, when making a 1-point adjustment), make sure that the reference condition represents the measurement environment well. The MI70 indicator is used now only as a terminal for visualizing and setting the transmitter's RH reading.

To complete the adjustment:

- ▶ 1. Remove the filter from the transmitter's probe and insert the probe into the reference condition.
2. Press **← Adjust** to continue adjusting.
3. Select **1-point adjustment** from the MI70 adjustment menu and press **← Select**.
4. Press **← Ready** when the reading has stabilized in the reference condition (note that the stabilization may require over 30 minutes). You can follow the stabilization from the graphical display by pressing **← Graph**.
5. Enter the correct reference value with the arrow buttons and press **← OK**.

6. Confirm the adjustment by pressing  **Yes**.
7. The adjustment is done. Press  **Back** and  **Exit** to return to the basic display.
8. Switch off MI70 and detach the connection cable.

7.2.3 2-point adjustment of HMT120/HMT130 using a calibrator













This procedure is 1 of the alternative methods for completing the adjustment described in [Calibrating and adjusting HMT120 and HMT130 series transmitters \(page 39\)](#).



Note that the difference between the 2 reference humidities must be at least 50 %RH. The MI70 indicator is used now only as a terminal for visualizing and setting the transmitter's %RH reading.

To complete the adjustment:

- ▶ 1. Remove the filter from the transmitter's probe and insert the probe into the lower reference condition.
2. Press  **Adjust** to continue adjusting.
3. Select **2-point adjustment** from the MI70 adjustment menu and press  **Select**.
4. Press  **Ready** when the reading has stabilized in the first reference condition (note that the stabilization may require over 30 minutes). You can follow the stabilization from the graphical display by pressing  **Graph**.
5. Enter the correct reference value of the first condition with the arrow buttons and press  **OK**.
6. Remove the probe from the first reference condition and insert the probe into the higher humidity reference condition.
7. Press  **Ready** when the reading has stabilized in the second reference condition (note that the stabilization may require over 30 minutes). You can follow the stabilization from the graphical display by pressing  **Graph**.
8. Enter the correct reference value of the second condition with the arrow buttons and press  **OK**.
9. Confirm the adjustment by pressing  **Yes**. If the difference between the 2 reference conditions is less than 50 %RH, adjustment cannot be done.
10. The adjustment is done. Press  **Back** and  **Exit** to return to the basic display.
11. Switch off MI70 and detach the connection cable.

7.2.4 LiCl-NaCl adjustment of HMT120/HMT130



This procedure is 1 of the alternative methods for completing the adjustment described in [Calibrating and adjusting HMT120 and HMT130 series transmitters](#) (page 39).

This adjustment is done using relative humidity references 11.3 %RH (LiCl) and 75.5 %RH (NaCl).

To complete the adjustment:

- ▶ 1. Remove the filter from the transmitter's probe and insert the probe into the LiCl salt chamber.
2. Press **Adjust** to continue adjusting.
3. Choose **LiCl-NaCl autom.** from the MI70 adjustment menu and press **Select**. Press **OK** to accept the note about references.
4. Press **Ready** when the reading has stabilized in the LiCl salt chamber (note that the stabilization may require over 30 minutes). You can follow the stabilization from the graphical display by pressing **Graph**.
5. Remove the probe from the LiCl salt chamber and insert the probe into the NaCl salt chamber.
6. Press **Ready** when the reading has stabilized in the NaCl salt chamber (note that the stabilization may require over 30 minutes). You can follow the stabilization from the graphical display by pressing **Graph**.
7. Confirm the adjustment by pressing **Yes**. If you press **No**, you return to the adjustment mode display and no changes are made.
8. The adjustment is done. Press **Back** and **Exit** to return to the basic display.
9. Switch off MI70 and detach the connection cable.

7.3 Calibrating and adjusting HMT330 series and PTU300 series transmitters

You can check and adjust the humidity and temperature channels of HMT330 and PTU300 with the HM70 meter. If you adjust both channels, make the temperature adjustment first. Calibrate your transmitter against a calibrated HMP70 series reference probe or against a calibrator's reference humidity by using the MI70 indicator in communication.

To connect HM70 to HMT330/PTU300 transmitters, you need the optional calibration cable (Vaisala item code 211339).







First carry out steps [step 1 ... step 9](#). After [step 9](#), choose 1 of the alternative methods for completing the adjustment.

To start the adjustment:

- ▶ 1. Connect calibration cable 211339 to the **SERVICE PORT** connector on the HMT330/PTU300 component board.
2. Connect the other end of the cable to either one of the connector ports located on the bottom of the MI70 indicator. See [Figure 2 \(page 13\)](#).
3. Switch on both devices.
4. The reading of the transmitter is shown on the first or middle row of the display, depending on the connector port to which the calibration cable is connected. The value of port I is shown on the upper row of the display and the value of port II on the lower row of the display. The difference of the readings is shown on the lowest row.
5. If you are using an HMT330 unit with the optional chemical purge function, activate the chemical purge before calibration and adjustment. To activate the purge with the MI70 indicator:





This step applies only to HMT330 series transmitters.

- a. Open **Menu** by pressing   **Open**
 - b. Select **Functions** and press  **Start** and  **Yes**
6. Press the **ADJ** button on the component board of the HMT330/PTU300 transmitter to open the adjustment mode. The indicator LED on the component board starts to flash.



After this step, the adjustment is carried out using the MI70 indicator.

7. Press  **OK** to start the adjustment.
8. Select **RH** or **T** and press  **Select**.
9. If you selected **RH**, check the environment settings if necessary. If checking the environment settings is not necessary, press  **No**. Complete the adjustment using 1 of the following alternative methods:
 - [Field checking and adjustment of HMT330/PTU300 using a calibrated reference probe \(page 45\)](#)
 - [1-point adjustment of HMT330/PTU300 using a calibrator \(page 45\)](#)
 - [2-point adjustment of HMT330/PTU300 using a calibrator \(page 46\)](#)
 - [LiCl-NaCl adjustment of HMT330/PTU300 \(page 47\)](#)

7.3.1 Field checking and adjustment of HMT330/PTU300 using a calibrated reference probe



This procedure is 1 of the alternative methods for completing the adjustment described in [Calibrating and adjusting HMT330 series and PTU300 series transmitters \(page 43\)](#). The examples shown here are for RH calibration: the same steps apply to temperature calibrations when that parameter is selected instead of RH.

To complete the adjustment:

- ▶ 1. Check that the probes are located in matching conditions and wait until the readings have stabilized (this may take 30 minutes or longer). If you are near the probes, do not breathe towards them.
2. Press **Adjust** to continue adjusting.
3. Choose **To same as RH_{I1/I1}** from the MI70 adjustment menu and press **Select**. MI70 automatically recognizes the port to which the HMP70 series probe is connected.
4. Confirm the adjustment by pressing **Yes**.
5. The adjustment is done. Press **Back** and **Exit** to return to the basic display.
6. Switch off MI70 and detach the calibration cable.

7.3.2 1-point adjustment of HMT330/PTU300 using a calibrator









This procedure is 1 of the alternative methods for completing the adjustment described in [Calibrating and adjusting HMT330 series and PTU300 series transmitters \(page 43\)](#).



When adjusting a transmitter in only 1 reference condition, make sure that the reference condition represents the measurement environment well. If you use Vaisala Humidity Calibrator HMK15, use the adapter fitting (13.5 mm) on the measurement hole if you calibrate probes of HMT334, HMT335, HMT337, or HMT338 transmitter models.

To complete the adjustment:

- ▶ 1. Remove the filter from the transmitter's probe and insert the probe into the reference condition.
2. Press **Adjust** to continue adjusting.
3. Select **1-point adjustment** from the MI70 adjustment menu and press **Select**.

4. Press  **Ready** when the reading has stabilized in the reference condition (note that the stabilization may take 30 minutes or longer). You can follow the stabilization from the graphical display by pressing  **Graph**.
5. Enter the correct reference value with the arrow buttons and press  **OK**.
6. Confirm the adjustment by pressing  **Yes**.
7. The adjustment is done. Press  **Back** and  **Exit** to return to the basic display.
8. Switch off MI70 and detach the calibration cable.

7.3.3 2-point adjustment of HMT330/PTU300 using a calibrator



This procedure is 1 of the alternative methods for completing the adjustment described in [Calibrating and adjusting HMT330 series and PTU300 series transmitters \(page 43\)](#).











The difference between the 2 reference humidities must be at least 50 %RH.

The MI70 indicator is used now only as a terminal for visualizing and setting the transmitter's RH reading.

If you use Vaisala Humidity Calibrator HMK15, use the adapter fitting (13.5 mm) on the measurement hole if you calibrate probes of HMT334, HMT335, HMT337, or HMT338 transmitter models.

To complete the adjustment:

- ▶ 1. Remove the filter from the transmitter's probe and insert the probe into the lower reference humidity.
2. Press  **Adjust** to continue adjusting.
3. Select **2-point adjustment** and press  **Select**.
4. Press  **Ready** when the reading has stabilized in the first reference condition (note that the stabilization may require 30 minutes or longer). You can follow the stabilization from the graphical display by pressing  **Graph**.
5. Enter the correct lower reference value with the arrow buttons and press  **OK**.
6. Remove the probe from the lower reference and insert the probe into the higher reference.
7. Press  **Ready** when the reading has stabilized in the second reference condition (note that the stabilization may require 30 minutes or longer). You can follow the stabilization from the graphical display by pressing  **Graph**.
8. Enter the correct higher reference value with the arrow buttons and press  **OK**.

9. Confirm the adjustment by pressing **Yes**. If you press **No**, you return to the adjustment mode display and no changes are made.



If the difference between 2 references is less than 50 %RH, the adjustment cannot be done.

10. The adjustment is done. Press **Back** and **Exit** to return to the basic display.

7.3.4 LiCl-NaCl adjustment of HMT330/PTU300



This procedure is 1 of the alternative methods for completing the adjustment described in [Calibrating and adjusting HMT330 series and PTU300 series transmitters \(page 43\)](#).

This adjustment is done using relative humidity references 11.3 %RH (LiCl) and 75.5 %RH (NaCl).

If you use Vaisala Humidity Calibrator HMK15, use the adapter fitting (13.5 mm) on the measurement hole if you calibrate probes of HMT334, HMT335, HMT337, or HMT338 transmitter models.

To complete the adjustment:

- ▶ 1. Remove the filter from the transmitter's probe and insert the probe into the 11.3 %RH reference humidity.
- 2. Press **Adjust** to continue adjusting.
- 3. Choose **LiCl-NaCl autom.** from the MI70 adjustment menu and press **Select**. Press **OK** to accept the note about references.
- 4. Press **Ready** when the reading has stabilized in the LiCl reference (note that the stabilization may require 30 minutes or longer). You can follow the stabilization from the graphical display by pressing **Graph**.
- 5. Remove the probe from the LiCl reference and insert the probe into the NaCl (75.5 %RH) reference.
- 6. Press **Ready** when the reading has stabilized in the second (NaCl) reference (note that the stabilization may require 30 minutes or longer). You can follow the stabilization from the graphical display by pressing **Graph**.
- 7. Confirm the adjustment by pressing **Yes**. If you press **No**, you return to the adjustment mode display and no changes are made.
- 8. The adjustment is done. Press **Back** and **Exit** to return to the basic display.

7.4 Calibrating and adjusting HMT310 series transmitters

Connecting HMT310 to HM70 (MI70 handheld indicator) requires Vaisala cable DRW216050SP (optional accessory). When you start to adjust HMT310 measurement with HM70, the adjustment mode must first be enabled by pressing the adjustment button inside the HMT310 enclosure.

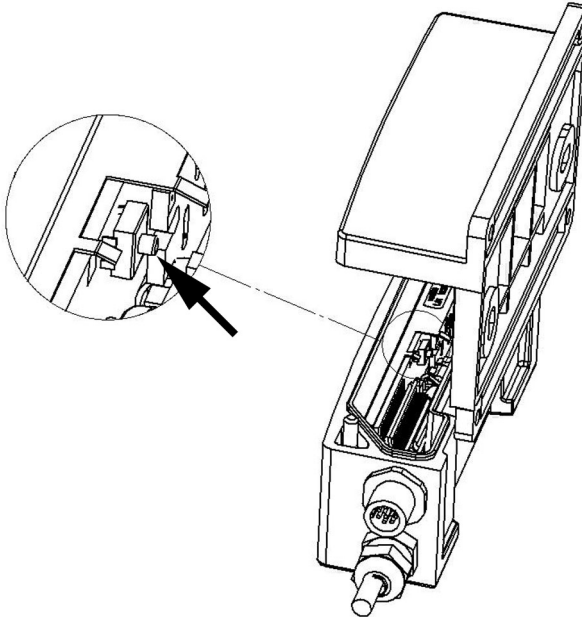

Figure 17 HMT310 adjustment button location

You can use HM70 to adjust the following in HMT310:

- Relative humidity (RH)
- Temperature (T)
- Pressure compensation value for humidity measurement (environment settings)



First carry out [step 1](#) ... [step 5](#). After [step 5](#), choose 1 of the alternative methods for completing the adjustment.

To start the adjustment:

- ▶ 1. Connect HMT310 to MI70 with the DRW216050SP cable.
- 2. Switch on the MI70 indicator.
- 3. Press the adjustment button inside the HMT310 enclosure (see [Figure 17 \(page 48\)](#)) to start HMT310's adjustment mode. A notification about the adjustment mode is displayed on the MI70 screen.
- 4. Press **⊖ OK** to enter the adjustment menu. The available adjustment options are displayed (**RH** or **T**). You can also view the date of the previous adjustment.
- 5. Choose **RH** or **T** with the arrow buttons and press **⊖ Select**. If you selected RH, check the environment settings if necessary. If checking the environment settings is not necessary, press **⊖ No**. Complete the adjustment using 1 of the following alternative methods:
 - [Field checking and adjustment of HMT310 using a calibrated reference probe \(page 49\)](#)
 - [1-point adjustment of HMT310 using a calibrator \(page 49\)](#)
 - [2-point adjustment of HMT310 using a calibrator \(page 50\)](#)
 - [Environment settings for HMT310 \(page 51\)](#)

7.4.1 Field checking and adjustment of HMT310 using a calibrated reference probe



This procedure is 1 of the alternative methods for completing the adjustment described in [Calibrating and adjusting HMT310 series transmitters \(page 48\)](#).

To complete the adjustment:

- ▶ 1. Check that the HMP70 series probe and the HMT310 probe are located in matching conditions and wait until the readings have stabilized. If you are near the probes, do not breathe towards them.
- 2. Press **⊖ Adjust** to continue adjusting.
- 3. Choose **To same as RH_{I/II}** from the MI70 adjustment menu and press **⊖ Select**. MI70 automatically recognizes the port to which the HMP70 series probe is connected.
- 4. Confirm the adjustment by pressing **⊖ Yes**.
- 5. The adjustment is done. Press **⊖ Back** and **⊖ Exit** to return to the basic display.
- 6. Switch off MI70 and detach the calibration cable.

7.4.2 1-point adjustment of HMT310 using a calibrator



This procedure is 1 of the alternative methods for completing the adjustment described in [Calibrating and adjusting HMT310 series transmitters \(page 48\)](#). The examples shown here are for RH calibration: the same steps apply to temperature calibrations when that parameter is selected instead of RH.



Usually it is recommended to make an adjustment in 2 reference conditions (2-point adjustment). When adjusting the transmitter in only 1 reference condition (1-point adjustment), make sure that the reference condition represents the measurement environment well. The MI70 indicator is used now only as a terminal for visualizing and setting the transmitter's RH reading.

To complete the adjustment:

- ▶ 1. Place the transmitter into the reference condition.
2. Press **Adjust** to continue adjusting.
3. Select **1-point adjustment** from the MI70 adjustment menu and press **Select**.
4. Press **Ready** when the reading has stabilized in the reference condition. You can follow the stabilization from the graphical display by pressing **Graph**.
5. Enter the correct reference value with the arrow buttons and press **OK**.
6. Confirm the adjustment by pressing **Yes**. To cancel entering the adjustment, press **No** to return to adjustment mode display without making any changes.
7. The adjustment is done. Press **Back** and **Exit** to return to the basic display.
8. Switch off the MI70 and detach the connection cable.

7.4.3 2-point adjustment of HMT310 using a calibrator









This procedure is 1 of the alternative methods for completing the adjustment described in [Calibrating and adjusting HMT310 series transmitters \(page 48\)](#). The examples shown here are for RH calibration: the same steps apply to temperature calibrations when that parameter is selected instead of RH.



Note that the difference between the 2 reference humidities must be at least 50 %RH. MI70 indicator is used now only as a terminal for visualizing and setting the transmitter's RH reading.

To complete the adjustment:

- ▶ 1. Insert the probe into the lower reference condition.
2. Press **Adjust** to continue adjusting.
3. Select **2-point adjustment** from the MI70 adjustment menu and press **Select**.
4. Press **Ready** when the reading has stabilized in the first reference condition. You can follow the stabilization from the graphical display by pressing **Graph**.
5. Enter the correct reference value of the first condition with the arrow buttons and press **OK**.

6. Remove the probe from the first reference condition and insert the probe into the higher humidity reference condition.
7. Press  **Ready** when the reading has stabilized in the second reference condition (note that the stabilization may take over 30 minutes). You can follow the stabilization from the graphical display by pressing  **Graph**.
8. Enter the correct reference value of the second condition with the arrow buttons and press  **OK**
9. Confirm the adjustment by pressing  **Yes**. If the difference between the 2 reference conditions is less than 50 %RH, adjustment cannot be done.
10. The adjustment is done. Press  **Back** and  **Exit** to return to the basic display.
11. Switch off the MI70 and detach the connection cable.

7.4.4 Environment settings for HMT310

When you select RH adjustment for the first time from the adjustment main menu, MI70 asks if you want to check the environment settings (pressure compensation value for humidity measurement). If you need to access the environment settings after this, exit the adjustment mode by selecting  **Exit** in the main adjustment menu and navigate to the environment menu from the MI70 main menu. To return to the adjustment mode, press the HMT310 adjustment button.

7.5 Checking and adjusting HMP155 probes

Both the active output version and the passive output version (only RH displayed) of HMP155 can be checked with MI70.

In the active output version, you can calibrate relative humidity, temperature, and additional T-probe temperature. In the passive output version, you can calibrate and adjust only relative humidity.

Connecting HM70 to HMP155 requires the optional connection cable (Vaisala item code 221801). When you use HM70 with the HMP155 probe, HMP155 is powered through the MI70 indicator

- ▶ 1. Connect HMP155 to MI70 with connection cable 221801.
- 2. Switch MI70 on by pressing the power button and follow the instructions on the display.



If you have the passive output version of HMP155, always hold down the **ADJ** button on the probe when you switch HMP155 on.

3. Activate the adjustment mode by holding down the **ADJ** button on HMP155 until the message below appears on the MI70 display.



4. Press **OK** to move on to the adjustment and select the parameter you want to adjust. The list of parameters displayed in the figure below varies according to the configuration of the HMP155 in use.



5. Follow the instructions given on the display to finish the adjustment.

8. Calibrating and adjusting HMP70 series probes

8.1 Probe calibration overview

The HM70 is fully calibrated as shipped from the factory. Adjustment should only be done if there is a reason to believe that the device is not within the accuracy specifications. However, if HM70 is used as a reference instrument in humidity measurements, the humidity recalibration is recommended every year.



Check when the latest adjustment was made from the **Last adjustment date** view or from the **Device information** view (see [Device information \(page 30\)](#)).

It is recommended to send the device to Vaisala for calibration: for contact information, see [Technical support \(page 69\)](#). Alternatively, you can calibrate and adjust HM70 by following the instructions given in this chapter.

When using Vaisala Humidity Calibrator HMK15, use the adapter fitting (13.5 mm hole) with HMP76 and HMP77 probes. The HMP75 probe does not need the adapter fitting. If the chemical purge option is available, always perform it before calibration (for instructions, see [Chemical purge \(optional\) \(page 36\)](#)). Before starting the adjustment mode, remove the screw that covers the calibration button. See [Figure 1 \(page 11\)](#) for the location of the button.

8.2 LiCl-NaCl automatic RH adjustment of HMP70 series probes

LiCl-NaCl automatic adjustment is a 2-point adjustment in reference humidities of 11.3 %RH (LiCl) and 75 %RH (NaCl). You do not have to feed the reference values, HM70 displays the accurate value based on the measured temperature and the Greenspan table stored in the memory of HM70.

Make the adjustment as instructed in [2-point RH adjustment of HMP70 series probes \(page 53\)](#) (select **LiCl--NaCl autom.** instead of **2-point adjustment** in [step 10](#) and follow the instructions on the display).

8.3 2-point RH adjustment of HMP70 series probes

Low humidity references 0 % (Nitrogen) / 11.3 % (LiCl) and higher humidity references 75 % (NaCl) / 97 % (K₂SO₄) are recommended for 2-point adjustment.



- The difference between the low and high reference must be at least 30 %RH
- The low reference can be at most 15 %RH

To make a 2-point adjustment:

- ▶ 1. When adjusting both relative humidity and temperature, make the temperature adjustment first.
2. Check that HM70 is turned on.
3. If the chemical purge option is available, perform it before adjustment. For instructions, see [Chemical purge \(optional\) \(page 36\)](#).
4. Detach the screw from the probe handle to expose the calibration button.
5. Press the calibration button in the probe handle with a thin sharp-pointed tool, such as a small screwdriver. Pressing the button switches the indicator to adjustment mode.
6. Press **⊖ OK** to start the adjustment mode.
7. Choose **RH** and press **⊖ Select**.
8. Press **⊖ Yes** to check the environment settings. To continue adjustment directly without checking the environment settings, press **⊖ No**.
9. The adjustment mode is now on. Press **⊖ Adjust** to select the adjustment method.
10. Choose **2-point adjustment** and press **⊖ Select**.



To carry out the LiCl-NaCl automatic adjustment described in [LiCl-NaCl automatic RH adjustment of HMP70 series probes \(page 53\)](#), choose **LiCl--NaCl autom.** instead.

11. Set the probe to the lower reference relative humidity. If using Vaisala Humidity Calibrator HMK15, use the adapter fitting (13.5 mm hole) with HMP76 and HMP77 probes. You can follow the stabilization from the graphical display by pressing **⊖ Graph**. Press **⊖ Ready** when the reading has stabilized.
12. Enter the correct lower reference humidity value with the arrow buttons and press **⊖ OK**.
13. Set the probe to the higher reference relative humidity. You can follow the stabilization from the graphical display by pressing **⊖ Graph**. Press **⊖ Ready** when the reading has stabilized.
14. Enter the correct higher reference humidity value with the arrow buttons and press **⊖ OK**.

15. Confirm the adjustment by pressing **Yes**. If you press **No**, you return to the adjustment mode display and no changes are made.



If the difference between the 2 references is less than 30 %, the adjustment cannot be done.

16. The adjustment is done. Press **Back** and **Exit** to return to the basic display.
17. Replace the screw on the calibration button.
You can attach a sticker on the calibration button screw to seal the calibration.

8.4 1-point RH adjustment of HMP70 series probes

Usually it is recommended to make an adjustment in 2 reference humidities. If you make an adjustment using 1 reference humidity (1-point adjustment), select the reference humidity so that it represents the measurement environment well.

Make the adjustment in 1 point as instructed in [2-point RH adjustment of HMP70 series probes \(page 53\)](#) (select **1-point adjustment** instead of **2-point adjustment** and follow the instructions on the display).

8.5 Making temperature adjustments

Temperature adjustment in 1 or 2 points can be done if there is reason to believe that the adjustment is changed. If the adjustment is done in 1 point only, make sure the reference condition represent the measurement environment well.



First begin the adjustment as instructed in this section, and then choose either [1-point T adjustment of HMP70 series probes \(page 56\)](#) or [2-point T adjustment of HMP70 series probes \(page 56\)](#) to complete the adjustment.

To start the adjustment:

- ▶ 1. Detach the screw from the probe handle to expose the calibration button.
- 2. Press the calibration button in the probe handle with a thin sharp-pointed tool, such as a small screwdriver. Pressing the button switches the indicator to adjustment mode.
- 3. Choose **T** and press **Select**.
- 4. The adjustment mode is now on. Press **Adjust** to select the adjustment method (1-point or 2-point adjustment).

8.6 1-point T adjustment of HMP70 series probes



Carry out the steps listed in [Making temperature adjustments \(page 55\)](#) before continuing with this adjustment option.

To complete the T adjustment using the 1-point adjustment method:

- ▶ 1. Choose **1-point adjustment** and press **Select**.
2. Set the probe to the reference temperature. You can follow the stabilization from the graphical display by pressing **Graph**. Press **Ready** when the reading has stabilized.
3. Enter the correct reference temperature value with the arrow buttons and press **OK**.
4. Confirm the adjustment by pressing **Yes**. If you press **No**, you return to the adjustment mode display and no changes are made.
5. The adjustment is done. Press **Back** and **Exit** to return to the basic display.

8.7 2-point T adjustment of HMP70 series probes







Carry out the steps listed in [Making temperature adjustments \(page 55\)](#) before continuing with this adjustment option.



The difference between the 2 references must be at least 30 °C or the adjustment cannot be done.

To complete the T adjustment using the 2-point adjustment method:

- ▶ 1. Choose **2-point adjustment** and press **Select**.
2. Set the probe to the lower reference temperature. You can follow the stabilization from the graphical display by pressing **Graph**. Press **Ready** when the reading has stabilized.
3. Enter the correct lower reference temperature value with the arrow buttons and press **OK**.
4. Set the probe to the higher reference temperature. You can follow the stabilization from the graphical display by pressing **Graph**. Press **Ready** when the reading has stabilized.
5. Enter the correct higher reference temperature value with the arrow buttons and press **OK**.

6. Confirm the adjustment by pressing  **Yes**. If you press  **No**, you return to the adjustment mode display and no changes are made.
7. The adjustment is done. Press  **Back** and  **Exit** to return to the basic display.

9. Maintenance

9.1 Changing the filter

Over time the probe filter will be contaminated with matter that you cannot remove by cleaning. This affects the probe's response time and measurement accuracy. Remove the old filter from the probe (see [Figure 1 \(page 11\)](#)) and replace it with a new one.

Note the following precautions:



CAUTION! Avoid touching the sensor.



CAUTION! Do not try to clean the filter.

More information

- [Spare parts and accessories \(page 66\)](#)

9.2 Error messages

If the HM70 displays an error message, check first that the sensor is connected properly. If there is condensed water in the probe, let the probe dry before resuming measurement.

In case of constant error, contact Vaisala (see [Technical support \(page 69\)](#)).

Table 7 List of HM70 error messages

Possible HM70 error messages
Voltage required for Purge unavailable
Voltage required for Preheat unavailable
Eeprom read/write error
ADC malfunction
Operating voltage out of range
Analog voltage out of range
Temperature/Humidity sensor open/short circuit
Temperature sensor current leak

Possible HM70 error messages
Temperature/humidity measurement malfunction
Temperature value out of range
Relative humidity value out of range
Sensor not found
Amplifier chain malfunction

10. Technical data

10.1 HMP75, HMP76, and HMP77 specifications

Table 8 HMP75, HMP76, and HMP77 measurement performance

Property	Description/Value
Relative humidity	
Measurement range	0 ... 100 %RH
Accuracy: 1) 2)	
At +15 ... +25 °C (+59 ... +77 °F)	±1 %RH (0 ... 90 %RH) ±1.7 %RH (90 ... 100 %RH)
At -20 ... +40 °C (-4 ... +104 °F)	±(1.0 + 0.008 x reading) %RH
At -40 ... +180 °C (-40 ... +356 °F)	±(1.5 + 0.015 x reading) %RH
Factory calibration uncertainty (+20 °C / +68 °F)	±0.6 %RH (0 ... 40 %RH) ±1.0 %RH (40 ... 97 %RH)
Response time (90%) at +20 °C (+68 °F) in still air:	
HMP75 (with standard plastic grid)	17 s
HMP76 (with standard sintered bronze filter)	60 s
HMP77 (with standard plastic grid and stainless steel netting)	50 s
Typical long-term stability	Better than 1%RH / year
Temperature	
HMP75 measurement range	-20 ... +60 °C (-4 ... +140 °F)
HMP76 measurement range	-50 ... +120 °C (-58 ... +248 °F)
HMP76 short time measurement range	-50 ... +180 °C (-58 ... +356 °F)
HMP77 measurement range	-70 ... +180 °C (-94 ... +356 °F)
Accuracy at +20 °C (+68 °F)	±0.2 °C (±0.36 °F), see the graph below
Output parameters	
Dew point, frost point, absolute humidity, mixing ratio, wet bulb temperature, water content, vapor pressure, saturation vapor pressure, enthalpy, water activity	

1) Including non-linearity, hysteresis, and repeatability.

2) Defined as ±2 standard deviation limits.

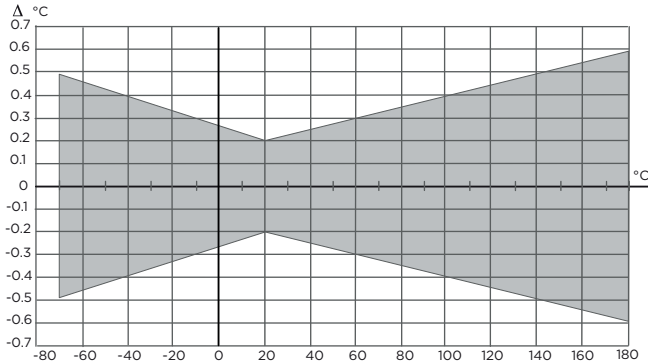

Figure 18 Temperature measurement accuracy over temperature range

Table 9 Calculated parameters

Property	Description/Value
Typical measurement range	
Dew point temperature	-20 ... +100 °C (-4 ... +212 °F)
Mixing ratio	0 ... 600 g/kg dry air
Absolute humidity	0 ... 600 g/m ³
Wet bulb temperature	0 ... +100 °C (32 ... +212 °F)
Enthalpy	0 ... 160 kJ/g
Water vapor pressure	0 ... 1000 hPa
Accuracy	
Accuracies of the calculated parameters depend on the calibration accuracy of the humidity and temperature sensors; here the accuracies are given for ±2 %RH and ±0.2 °C.	
	Relative humidity
Temp.	10 20 30 40 50 60 70 80 90 100
-40	1.86 1.03 0.76 0.63 0.55 0.50 0.46 0.43 — —
-20	2.18 1.19 0.88 0.72 0.62 0.56 0.51 0.48 — —
0	2.51 1.37 1.00 0.81 0.70 0.63 0.57 0.53 0.50 0.48
20	2.87 1.56 1.13 0.92 0.79 0.70 0.64 0.59 0.55 0.53
40	3.24 1.76 1.27 1.03 0.88 0.78 0.71 0.65 0.61 0.58
60	3.60 1.96 1.42 1.14 0.97 0.86 0.78 0.72 0.67 0.64
80	4.01 2.18 1.58 1.27 1.08 0.95 0.86 0.79 0.74 0.70
100	4.42 2.41 1.74 1.40 1.19 1.05 0.95 0.87 0.81 0.76
120	4.86 2.66 1.92 1.54 1.31 1.16 1.04 0.96 0.89 0.84
140	5.31 2.91 2.10 1.69 1.44 1.26 1.14 1.05 0.97 0.91
160	5.80 3.18 2.30 1.85 1.57 1.38 1.24 1.14 1.06 0.99

Figure 19 Accuracy of dew point temperature °C

Property		Description/Value								
	Relative humidity									
Temp.	10	20	30	40	50	60	70	80	90	100
-40	0.003	0.003	0.003	0.003	0.003	0.004	0.004	0.004	—	—
-20	0.017	0.018	0.019	0.021	0.022	0.023	0.025	0.026	—	—
0	0.08	0.09	0.09	0.10	0.10	0.11	0.11	0.12	0.13	0.13
20	0.31	0.33	0.35	0.37	0.39	0.41	0.43	0.45	0.47	0.49
40	0.97	1.03	1.10	1.17	1.24	1.31	1.38	1.46	1.54	1.62
60	2.68	2.91	3.16	3.43	3.72	4.04	4.38	4.75	5.15	5.58
80	6.73	7.73	8.92	10.34	12.05	14.14	16.71	19.92	24.01	29.29
100	16.26	21.34	28.89	40.75	60.86	98.85	183.66	438.56	—	—
120	40.83	74.66	172.36	—	—	—	—	—	—	—

Figure 20 Accuracy of mixing ratio g/kg (ambient pressure 1013 mbar)

	Relative humidity									
Temp.	10	20	30	40	50	60	70	80	90	100
-40	0.20	0.20	0.20	0.20	0.20	0.20	0.20	0.20	—	—
-20	0.21	0.21	0.22	0.22	0.22	0.22	0.23	0.23	—	—
0	0.27	0.28	0.28	0.29	0.29	0.29	0.30	0.30	0.31	0.31
20	0.45	0.45	0.45	0.44	0.44	0.44	0.43	0.43	0.42	0.42
40	0.84	0.77	0.72	0.67	0.64	0.61	0.58	0.56	0.54	0.52
60	1.45	1.20	1.03	0.91	0.83	0.76	0.71	0.67	0.63	0.60
80	2.23	1.64	1.32	1.13	0.99	0.89	0.82	0.76	0.72	0.68
100	3.06	2.04	1.58	1.31	1.14	1.01	0.92	0.85	0.80	0.75
120	3.85	2.40	1.81	1.48	1.28	1.13	1.03	0.95	0.88	0.83
140	4.57	2.73	2.03	1.65	1.41	1.25	1.13	1.04	0.97	0.91
160	5.25	3.06	2.25	1.82	1.55	1.37	1.24	1.13	1.05	0.99

Figure 21 Accuracy of wet bulb temperature °C

	Relative humidity									
Temp.	10	20	30	40	50	60	70	80	90	100
-40	0.004	0.004	0.005	0.005	0.005	0.006	0.006	0.006	—	—
-20	0.023	0.025	0.027	0.029	0.031	0.032	0.034	0.036	—	—
0	0.10	0.11	0.12	0.13	0.13	0.14	0.15	0.15	0.16	0.17
20	0.37	0.39	0.41	0.43	0.45	0.47	0.49	0.51	0.53	0.55
40	1.08	1.13	1.18	1.24	1.29	1.34	1.39	1.44	1.49	1.54
60	2.73	2.84	2.95	3.07	3.18	3.29	3.40	3.52	3.63	3.74
80	6.08	6.30	6.51	6.73	6.95	7.17	7.39	7.61	7.83	8.05
100	12.2	12.6	13.0	13.4	13.8	14.2	14.6	15.0	15.3	15.7
120	22.6	23.3	23.9	24.6	25.2	25.8	26.5	27.1	27.8	28.4
140	39.1	40.0	41.0	42.0	43.0	44.0	45.0	45.9	46.9	47.9
160	63.5	64.9	66.4	67.8	69.2	70.7	72.1	73.5	74.9	76.4

Figure 22 Accuracy of absolute humidity g/m³

Table 10 HMP75, HMP76, and HMP77 general specifications

Property	Description/Value
Humidity sensor	HUMICAP® 180R HUMICAP® 180RC (chemical purge, sensor preheat)
Temperature sensor	PT100 RTD Class F0.1 IEC 60751
Operating temperature range for electronics	-40 ... +60 °C (-40 ... +140 °F)
Standard sensor protection	
HMP75	Plastic grid
HMP76	Sintered bronze filter
HMP77	Grid with SS netting

Table 11 HMP75, HMP76, and HMP77 mechanical specifications

Property	Description/Value
IP rating	IP65 (NEMA 4)
Housing material	ABS/PC blend
Probe material	Stainless steel (AISI316L)
Probe cable length (between indicator and probe handle)	1.9 m (6.2 ft)
Probe cable length of HMP77 (from handle to the root of probe)	5.0 m (16 ft)
Probe diameter	12 mm (0.47 in)
Weight	
HMP75	250 g (8.8 oz)
HMP76	350 g (12 oz)
HMP77	500 g (18 oz)

10.2 MI70 specifications

Table 12 MI70 measurement indicator

Property	Description/Value
Operating environment	
Operating temperature	-10 ... +40 °C (+14 ... +104 °F)

Property	Description/Value
Operating humidity	0 ... 100 %RH, non-condensing
Storage temperature	-40 ... +70 °C (-40 ... +158 °F)
Inputs and outputs	
Max. no of probes	2
PC interface	MI70 Link software with USB or serial port cable
Analog output	0 ... 1 VDC
Power supply	Rechargeable NiMH battery pack with AC adapter or 4 × AA size alkalines, type IEC LR6
Output resolution	0.6 mV
Accuracy	0.2 % full scale
Temperature dependence	0.002 %/°C (0.01 %/°F) full scale
Minimum load resistor	10 kΩ to ground
Mechanical specifications	
Housing classification	IP54
Housing materials	ABS/PC blend
Weight	400 g (14 oz)
Compatibility	
EMC compliance	EN 61326-1, portable equipment
Other	
Menu languages	English, Chinese, Spanish, Russian, French, Japanese, German, Swedish, Finnish
Display	<ul style="list-style-type: none"> • LCD with backlight • Graphic trend display of any parameter • Character height up to 16 mm (0.63 in)
Alarm	Audible alarm function
Data logging capacity	2700 real time data points
Logging interval	1 s to 12 h
Logging duration	1 min ... memory full
Resolution	0.01 %RH, 0.01 °C/°F, 0.01 hPa, 0.01 a _w , 10 ppm / 0.01 %CO ₂

Table 13 MI70 battery operation time

Property	Value/Description
Typical charging time	4 hours
Operation times	
Continuous use	48 h typical at +20 °C (+68 °F)
Data logging use	Up to a month

10.3 Dimensions

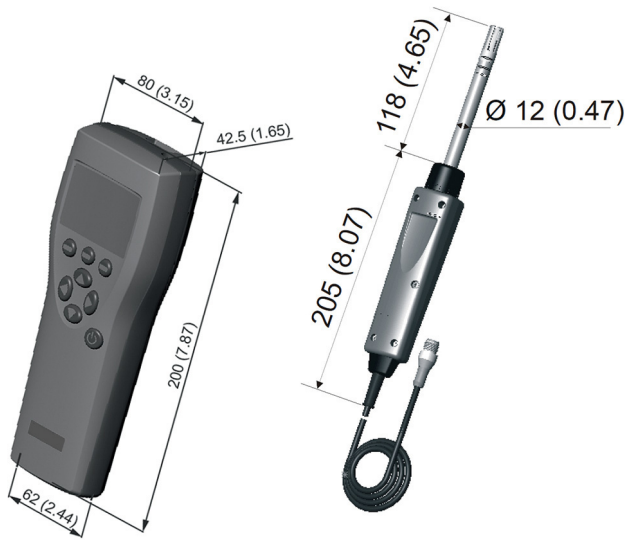

Figure 23 MI70 indicator and HMP75 probe dimensions in mm (inches)

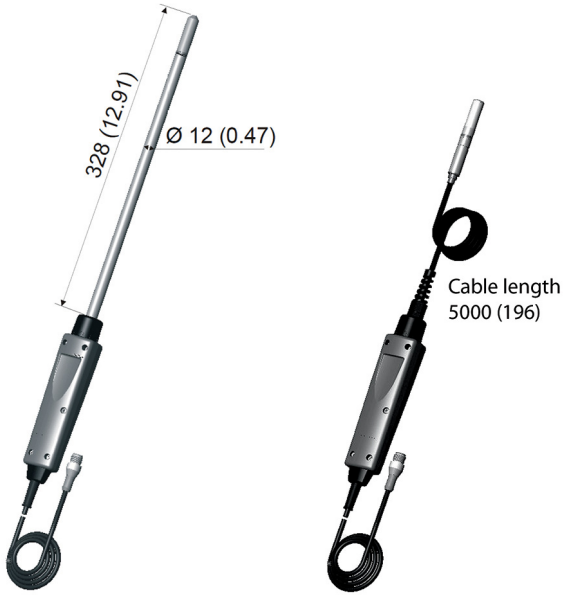

Figure 24 HMP76 and HMP77 probe with cable, dimensions in mm (inches)

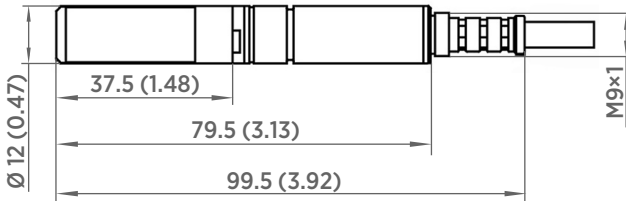

Figure 25 HMP77 probe dimensions in mm (inches)

10.4 Spare parts and accessories



Information on spare parts, accessories, and calibration products is available online at www.vaisala.com and store.vaisala.com.

Table 14 HM70 spare parts and accessories

Description	Item code
AC adapters	
Euro AC adapter	MI70EUROADAPTER
UK AC adapter	MI70UKADAPTER
US AC adapter	MI70USADAPTER
AUS AC adapter	MI70AUSADAPTER
MI70 All adapter	MI70ALLADAPTER
Cables	
Analog output signal cable	27168ZZ
Connection cable for HMT310 series	DRW216050SP
Connection cable for HMP155	221801
Connection cable for TMP115, HMD60 series, HMP60 and HMP110 series, HMW90 series, HMDW110 series, and GMW90 series	219980SP
1-m (3.3-ft) flat extension cable for 219980SP	CBL210649SP
Probe extension cable (10 m (33 ft))	213107SP
Connection cable for HMT330 and HMT120/HMT130	211339
Carrying cases	
Weatherproof carrying case for MI70 and short probe (HMP75/77)	MI70CASE3
Weatherproof carrying case for MI70 and long probe (HMP76)	MI70CASE4
Soft carrying case for MI70 and short probe (HMP75/77)	MI70SOFTCASE
Probe accessories	
Plastic PC grid filter (HMP75)	6221
Membrane filter (HMP75)	10159HM
Sintered bronze filter (HMP75)	DRW212987SP
Plastic PPS grid filter (HMP76/77)	DRW010276SP
Sintered stainless steel filter (HMP76/77)	HM47280SP
Sintered bronze filter (HMP76 standard)	DRW212987SP
PPS grid with SS netting (HMP77 standard)	DRW010281SP
Probe holder (only for HMP76)	HM36915
Others	
Measurement indicator	MI70

Description	Item code
USB PC connection cable (for use with MI70 Link software) ¹⁾	219687
Rechargeable battery for MI70	26755

1) *Vaisala MI70 Link software for Windows is available at www.vaisala.com/mi70link.*

Maintenance and calibration services



Vaisala offers comprehensive customer care throughout the life cycle of our measurement instruments and systems. Our factory services are provided worldwide with fast deliveries. For more information, see www.vaisala.com/calibration.

- Vaisala Online Store at store.vaisala.com is available for most countries. You can browse the offering by product model and order the right accessories, spare parts, or maintenance and calibration services.
- To contact your local maintenance and calibration expert, see www.vaisala.com/contactus.

Technical support



Contact Vaisala technical support at helpdesk@vaisala.com. Provide at least the following supporting information as applicable:

- Product name, model, and serial number
- Software/Firmware version
- Name and location of the installation site
- Name and contact information of a technical person who can provide further information on the problem

For more information, see www.vaisala.com/support.

Warranty

For standard warranty terms and conditions, see www.vaisala.com/warranty.

Please observe that any such warranty may not be valid in case of damage due to normal wear and tear, exceptional operating conditions, negligent handling or installation, or unauthorized modifications. Please see the applicable supply contract or Conditions of Sale for details of the warranty for each product.

Recycling



Recycle all applicable material.



Follow the statutory regulations for disposing of the product and packaging.

VAISALA

www.vaisala.com

