

Operation Manual

KSAT[®]

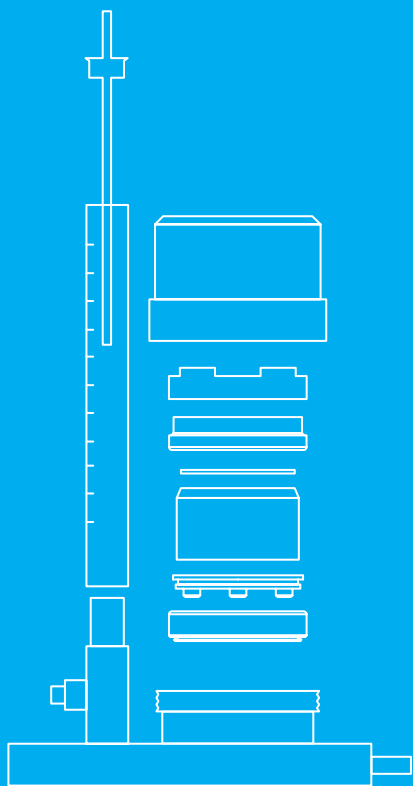

METER

At a glance – how it works

The device measures the hydraulic conductivity, K_s , of saturated soil samples. Measurements are based on the Darcy equation.

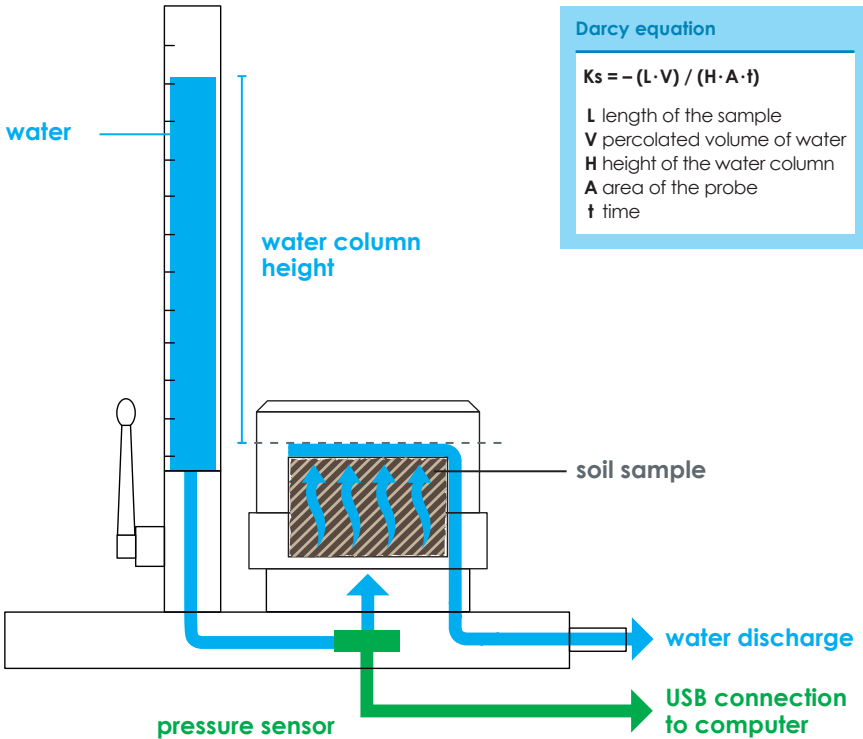

Note: Key

Illustrations

■ water

■ soil

■ electronics

■ saturated soil

■ air

■ all other parts

Instructions

The blue column gives step-by-step instructions on how to work with this device, e.g. "Put the sample ring on the gasket with the porous plate."

The grey column shows the expected results of your work.

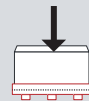

Content

Theory	3
General remarks	3
Measurement Principle	3
Soil sampling and sample saturation	4
Classification of K_f values	5
Percolation fluid	6
Initial operation	7
Configuring the device	8
Considering the porous plate resistance	10
Setting zero point	12
Preparing the measurement	13
Saturating the soil sample	13
Mounting the sample for measurement	16
How to avoid drying out the sample during long term measuring	19
Simulating a measurement	19
Measuring with the falling head technique	20
Standard measuring procedure	21
Fast measurement of samples with very low permeability	24
Evaluation	26
Measuring with the constant head technique	27
Prerequisites	27
Measurement	28
Evaluation	29
End of a measuring campaign	30
Export of data	30
Start stop interval	32
Typical measuring results	33
Reasons for a non-constant conductivity	34
How to avoid trouble	35
Installing the USB driver manually	36
Firmware Update	37
Cleaning and maintenance	38
Accessories	39
Facts and data	41
Technical data	41
Intended use	41
Warranty	41
Bibliography	42

Parts of the device and scope of delivery

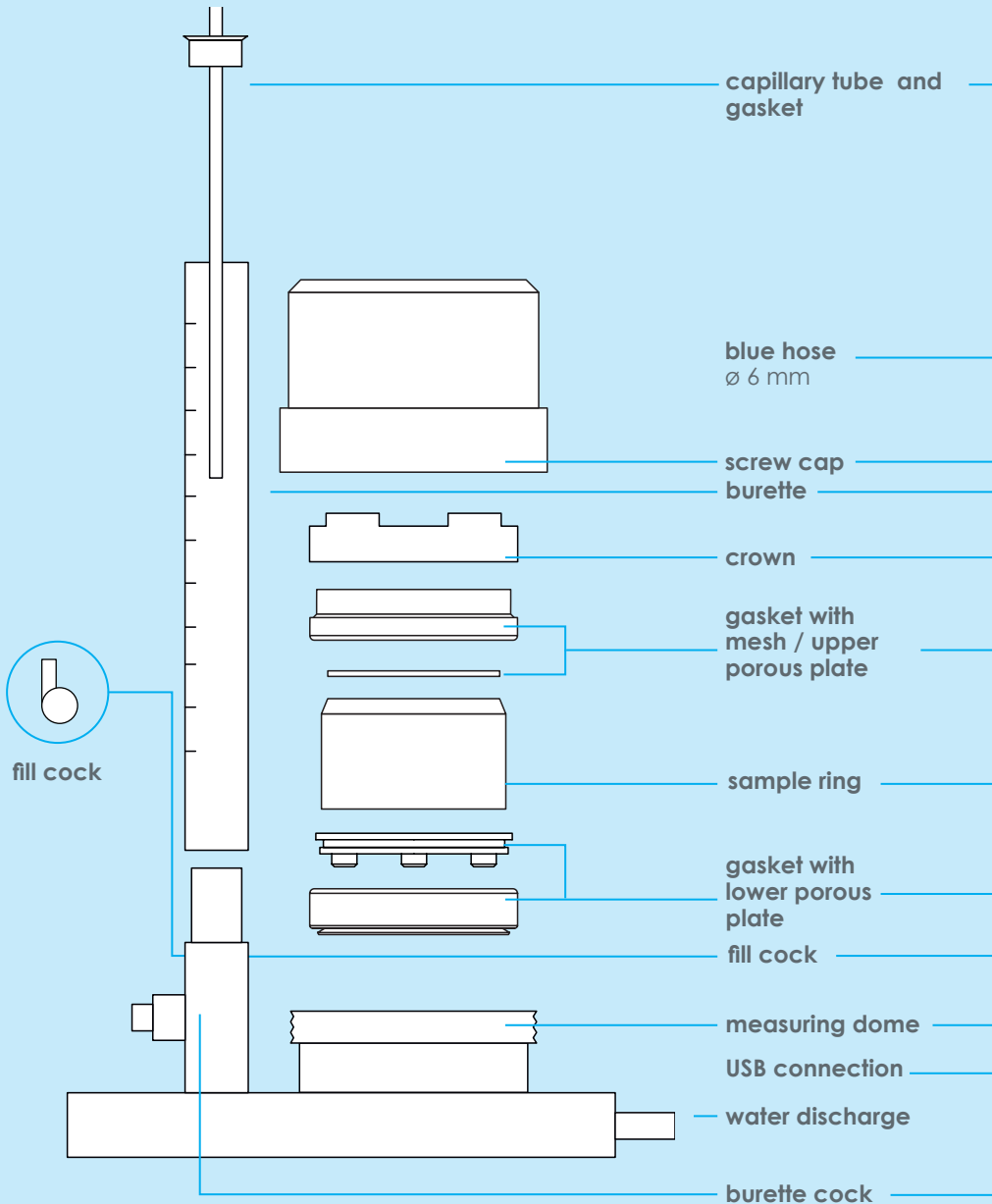

5 liter water tank



Also included

- KSAT VIEW® software for download
- 5 liter (1.32 gal) water tank
- 1.2 meter (4 ft) supply hose
- 1.2 meter (4 ft) discharge hose
- trough for saturating soil samples
- stainless steel plate for pressure sensor testing
- wiper plate

For stable materials

gasket with mesh



For instable materials

gasket with porous plate



water discharge
(white hose Ø 12 mm)

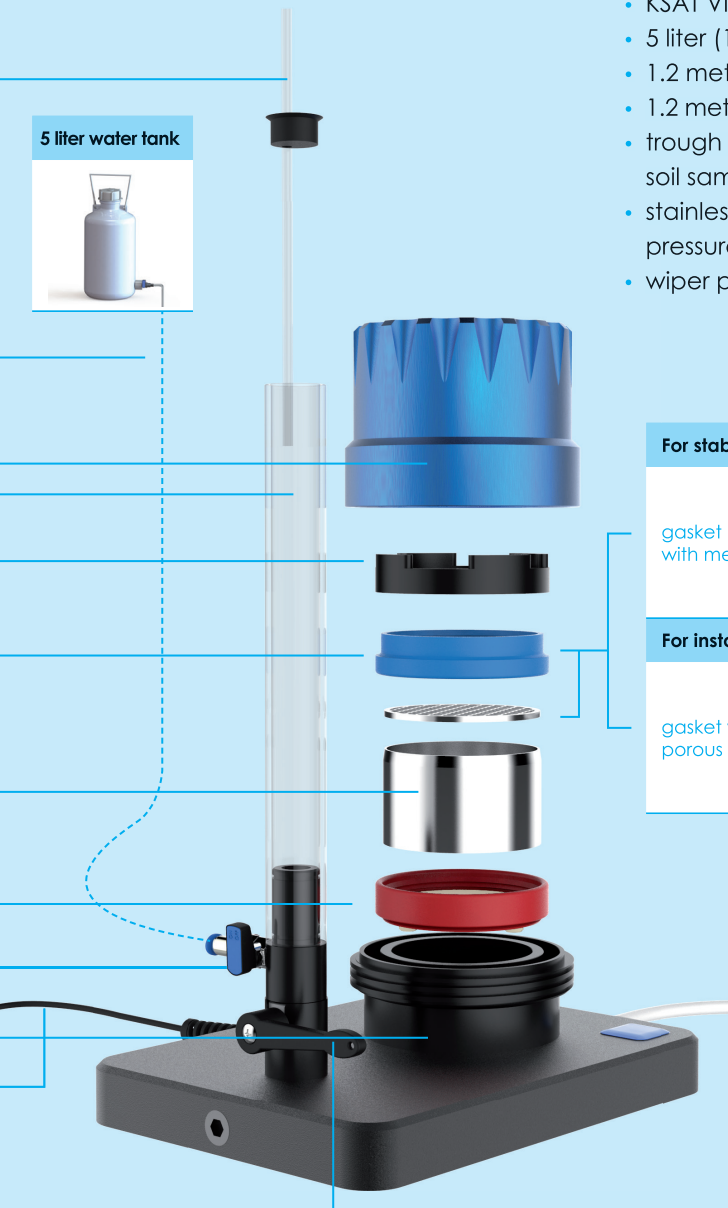

Theory

General remarks

Water storage and water conduction are of critical importance for a variety of ecosystem processes in terrestrial ecosystems. The design and functioning of subsurface drainage systems for example depend to a great extent on the soil's saturated hydraulic conductivity. Furthermore, it plays a key role in the transport of nutrients and pollutants. It is the decisive factor for the design of irrigation and drainage systems.

Measurement Principle

A fully water saturated soil core is percolated perpendicular to its cross-section with degassed water at room temperature. The flow rate and the driving hydraulic gradient are measured.

Water permeability (K_s) is calculated from the volumetric water flux V divided by the soil sample area A and time t , the length of the soil sample L and the hydraulic head gradient H along the flow direction.

According to Darcy (1856), the flux density $q = Q/A$ in laminar flow is proportional to the hydraulic gradient:

$$q = \frac{V}{A \cdot t} = -K_s \frac{H}{L} \quad \text{and} \quad K_s = \frac{LV}{HA t}$$



Henry Darcy
(1803 – 1885)

Soil sampling and sample saturation

According to DIN-ISO 19683-9, water permeability measurements can be performed with disturbed or undisturbed soil samples in steel cylinders. Packed samples do not allow conclusions about the in-situ conductivity, which is usually determined by the soil structure.

The following instructions outline how to take undisturbed soil samples

- place the steel ring at the desired depth with the sharpened edge on the exposed soil.
- Use a proper mid-size vibration-free hammer and the METER hammering adaptor SZA 250 to drive the ring straight and without any tilting into the ground (vertically or horizontally).
- Carefully excavate the ring with a knife or spatula. Take care that all the soil in the steel cylinder remains intact, i. e., that undisturbed soil extends slightly beyond both sides of the cylinder's edges.
- Now cut off the overlapping soil along the ring's rim with a sharp knife or metal saw blade - make sure to get plane surfaces (top and bottom) and not to smear the pores. If roots are present, it might be necessary to cut them off with scissors.
- Cover the samples with protective caps for transportation (see also accessories).

When determining the saturated hydraulic conductivity it is critical that there are no gaps, crevices or cracks in the sample along the direction of percolation. The biggest problem are the edge gaps. Soil cores that were tilted during the sampling are likely to have such edge gaps and should be discarded. According to Dirksen (1999), the accuracy of the measurement is not the major challenge, but the quality and representativeness of the soil samples in the determination of the saturated hydraulic conductivity. For undisturbed samples, at least 5 to 10 samples need to be taken to get representative mean values.

Classification of k_f values

Unless otherwise stated, k_f respectively K_s values in the literature usually refer to water. If permeability is known for water, permeability of other fluids can be estimated.

Water permeability classes according to DIN 18130

very highly permeable	$>10^{-2}$ m/s
highly permeable	10^{-2} to 10^{-4} m/s
permeable	10^{-4} to 10^{-6} m/s
slightly permeable	10^{-6} to 10^{-8} m/s
very weakly permeable	$< 10^{-8}$ m/s

Conductivities for unconsolidated aquifers (water)

pure gravel	10^{-1} to 10^{-2} m/s
coarse sand	approx. 10^{-3} m/s
medium-grained sand	10^{-3} to 10^{-4} m/s
fine-grained sand	10^{-4} to 10^{-5} m/s
silty sand	10^{-5} to 10^{-7} m/s
silty clay	10^{-6} to 10^{-9} m/s
clay	$< 10^{-9}$ m/s

The transition from a permeable to an impermeable soil is at approximately 10^{-6} m/s. Soils with a k_f value $< 10^{-9}$ m/s are almost water impermeable.

Percolation fluid

According to DIN (DIN 19693-9, 1998, DIN 18130-1, 1998), "degassed water of low ionic strength at room temperature" can be used. Degassed tap water is normally fine. If used for clay soils, addition of a weak solution of a divalent cation (e.g., 0.01 M CaCl_2 solution; McKenzie et al., 2002) is appropriate. Degassing can be achieved by boiling, or by keeping the water for a while under vacuum pressure while continuously stirred.

The ionic strength of the soil solution considerably influences the width of the electric double layer of soil, and thus affects hydraulic conductivity in particular for clayey soils. In the ideal case, a percolation fluid is used with an electrolyte content, which is similar to the in-situ soil solution. In clayey soils, the use of monovalent cations will lead to dispersion of the clay particles and to movement of particles that are possibly clogging the structural pore system.

The percolation fluid is stored in a vessel, which is mounted above the device, and connected by a tube at the base of the burette. The filling of the burette is conveniently done by opening the filling valve to the storage vessel. In regular operation, only about 5 cm of water are used in one measurement run. The laminar flow of water from the storage vessel into the burette minimizes contact of the percolation fluid with the atmosphere and thus back diffusion of air. Also, the stored water will be always at ambient temperature.

Initial operation

Put the KSAT® VIEW CD into your computer or download software from metergroup.com/app/uploads/2017/06/KSAT-Software.zip. Double click **ksat.msi** and follow the installation wizard.

The wizard assists you through the installation.

If the KSAT® USB driver does not install automatically then install it manually (see paragraph Installing the USB driver manually)

Connect the device to your computer's USB port.

Start the KSAT VIEW® software.

The device connects automatically with your computer.

Connect the water supply and discharge hoses.

You are ready to measure!

Note

For installing the KSAT VIEW® software you may need administrator rights.

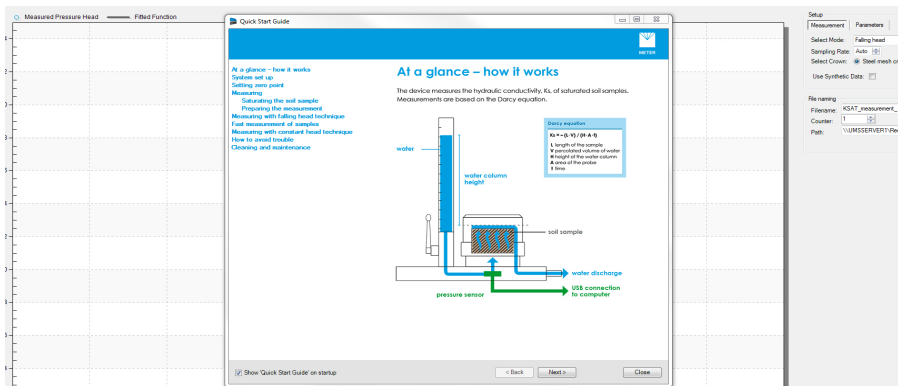

Configuring the device

In the menu "File naming" you can give a name to your measuring campaign and save it.

Command	Format	Explanation	Default
file name	alphanumeric	select without limitation	-
counter	numeric	counts number of measurements per campaign automatically	-
path	e.g. C:\Documents\ User\METER\KSAT...	select drive and file for your measuring data	measuring data are saved in .csv format

In the menu "Setup" and window "test parameter" you can change the parameters listed below. Usually you do not need to change the configuration. So please change only parameters if you change the measuring setup.

Command	Format	Explanation	Default
Operation parameters			
H_end_abs	[cm]	Hydraulic head difference at stop of measurement	0.5
H_end_rel	[-]	Relative hydraulic head (with respect to initial pressure head) to stop measurement	0.25
dH_min	[cm]	Minimum pressure head difference that leads to a new measurement in the „auto“ data registration mode“	0.1
dH_ini	[cm]	Minimum pressure head increase to detect automatic start of measurements	1
Geometry parameters			
A_bur	[cm ²]	Burette cross section area	4.524
A_cap_in	[cm ²]	Capillary inner cross section area	0.075
A_cap_out	[cm ²]	Capillary outer cross section area	0.224
A_sample	[cm ²]	Sample cross section area	50
L_bur	[cm]	Burette height	22.5
L_sample	[cm]	Sample height	5
L_plate_Bottom	[cm]	Bottom porous plate height	0.8
L_plate_Top	[cm]	Upper porous plate height	0.3
Evaluation parameters			
T_ref	[°C]	Reference temperature	10
K_plate	[cm/d]	Porous plate conductivity	14000
Use Auto-Offset	[-]	Use auto offset adjustment	True
Max Auto-Offset	[cm]	Max value for auto offset correction	1

In the window "Measurement" you select the measurement mode ("Falling head" or "Constant head"), the rate of data recording (fixed time intervals or flexible time intervals dependent on the decrease of the water level, and the kind of crown used (crown with mesh or porous plate).

Command	Format	Explanation	Default
Sampling rate	[mm:ss]	Auto, min. 1 s, max. 24:00 h	Auto

In standard operation, we recommend using the crown with mesh. For strongly erosive soils with a high fraction of silt particles, it might be advisable to select the crown with the porous plate to minimize the risk of soil erosion.

Select water column level where you are going to press "click here" in the menu "Setup" and window "constant head steps" (modus constant head).

For entering an additional value press "add", for entering the level press "insert". To delete a level press "delete".

Command	Format	Explanation	Default
[0], [1], [2], ...	-	sequence of burette meter readings	-
digit	[cm]	water column height	-

Consideration of the system resistance

If the conductivity of the soil is very high, the resistance of the measuring system, in particular the porous plates, must be taken into account explicitly. Per default, the plate resistance $1/K_{\text{Plate}}$ is set as default value in the system parameter list.

The conductivity of the soil is calculated from the effective conductivity K_{eff} of the system, given by

Since the resistances ($R = L/k$) of plate and soil add, it follows

$$\frac{L_{\text{Sample}} + L_{\text{Plate}}}{K_{\text{eff}}} = \frac{L_{\text{Sample}}}{K_{\text{S}}} + \frac{L_{\text{Plate}}}{K_{\text{Plate}}}$$

Rearrangement gives

$$K_{\text{S}} = \frac{L_{\text{Sample}}}{\frac{L_{\text{Sample}} + L_{\text{Plate}}}{K_{\text{eff}}} - \frac{L_{\text{Plate}}}{K_{\text{Plate}}}}$$

where	Symbol	Unit	Description
	L_{Sample}	[cm]	Sample length
	L_{Plate}	[cm]	Plate thickness
	k_{Plate}	[cm/d]	Saturated conductivity of the plate
	k_{S}	[cm/d]	Saturated conductivity of the sample

Considering the porous plate resistance

KSAT VIEW considers the impact of the plate resistance even when it is only relevant with extremely conductive samples. KSAT VIEW considers a system conductivity of 14000 cm/d at a plate thickness of 0.8 cm. Aging and soiling may change the plate resistance.

Be sure to keep the plate clean to avoid a falsified conductivity value. If cleaning the plate is not possible anymore please replace it.

Impact of temperature on K_s

The hydraulic conductivity depends on the temperature. Measurements take place at ambient room temperature. The device measures the actual temperature and computes the K_s values referring to the selected reference temperature.

by using this equation

$$\eta = 0.0007 T^2 - 0.0531T + 1.764$$

mit $r^2 = 0.9996$

where	η	[mPa · s]	dynamic viscosity of water
	T	[° C]	reference temperature

Additionally KSAT VIEW calculates the true measured value of a viscosity-corrected saturated conductivity at a reference temperature T_{ref} , that you can specify in the test parameters menu.

In the table below you find a few viscosity values.

Temperature in °C	5	10	15	20	25
Dynamic viscosity of pure water [mPa s], at 1 bar	1.518	1.306	1.137	1.001	0.894

Setting zero point

Fill burette by opening the fill cock, then close it.
Fill measuring dome by opening the burette cock.

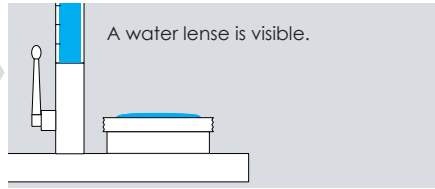

Close burette cock.
Put wiper plate on the water lens and take it off horizontally.
Select "Offset recalibration" in the software.
Select "Setting zero point" button.

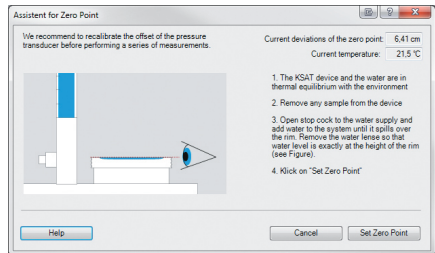
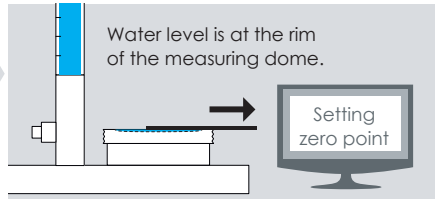

Software assistant for setting zero point

Note: pressure reading

In the mode "measuring" the screen shows the value -6.9 cm (-3 in) water column after setting zero point. This is because the measuring setup is 6.9 cm (3 in) high.

Note: percolation fluid

Conventional tap water (preferably degassed) should be used for the measurement. For detailed information see "percolation fluid" on page 6.

Preparing the measurement

Saturating the soil sample

Note:

This procedure refers to the use of a 250 ml soil sampling ring. Using a 100 ml soil sampling ring please consider the additional manual "Mounting and application of the 2 inches adapter for KSAT and HYPROP".

Note:

The pores of the porous plate must be completely filled with water before being placed on the soil sample. You observe a complete saturation of the porous plate when it does not float in water, but settles.

If you want to use a dried out plate immediately, it is advisable to saturate it quickly under vacuum in a desiccator. Submerge the plate in water (with a weight on it to avoid floating) and evacuate the system. Then bring it back to atmospheric pressure.

If you keep the saturated plate horizontal you can move it as the water will be adhered in the pores. Avoid turning the plate into a vertical position. Gravity force will dewater the plate from the top.

Remove the lid from the sample ring (the cutting side). Clean the sealing area thoroughly.

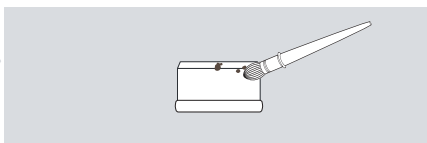

Put the saturation plate, covered with a filter paper, on top of the sample ring.

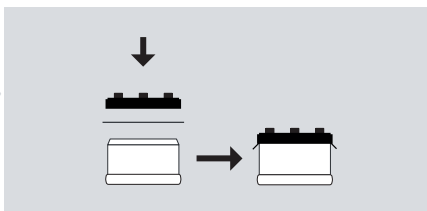

Turn the whole setup upside down and remove the other lid. Put the setup in a water pan.

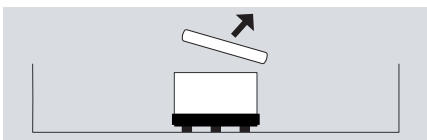

Fill the water pan with approx. 2 cm de-gassed tap water. Tilt it so that air bubbles can escape.

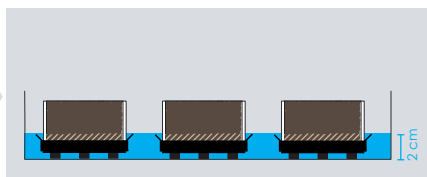

Raise the water level almost to the sample height (recommended times see below). Do not pour water on the sample – you may trap air. Use the time table below for a reference to determine how long samples take to saturate. Do not pour water on the sample – you may trap air.

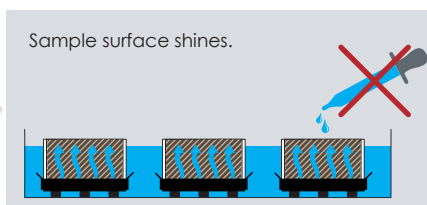

The sample is saturated as soon as its surface is glossy. You can check that using a flashlight. As soon as the sample is saturated fill the pan with at least 12 cm water so that the sample is flooded.

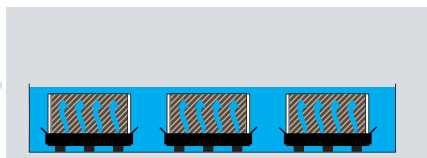

Saturate the porous plate of the red sealing (see note on previous side). Place the red sealing with the saturated porous plate in the same water filled pan. Be cautious to keep it horizontally while moving. Clean the sealing area of the sample ring and put the red sealing under water on top of the sampling ring.

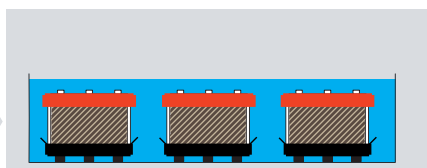

Turn the setup under water upside down and remove the saturation plate as well as the filter paper.

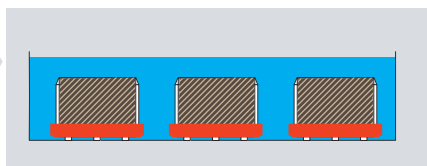

Note:

For reduction of a swelling of the soil sample we recommend to put another saturation plate with filter paper on the sample. Put a defined burden (appropriate to the burden of the predominant soil of the original storage) on top and place the sample in the trough (shown in adjacent picture). Tilt the sample to remove entrapped air from below the sample.

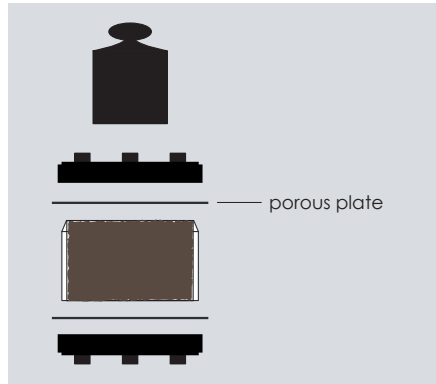

Note: How long saturation typically takes

material	fill up after (approx.)	saturated after (approx.)
coarse sand	9 min	10 min
fine sand	45 min	1 hrs
silt	6 hrs	24 hrs
clay	n. a.	up to 2 weeks

Mounting the sample for measurement

Open fill cock and fill burette.
Close fill cock, open burette cock and flood the measuring dome until the burette is empty.

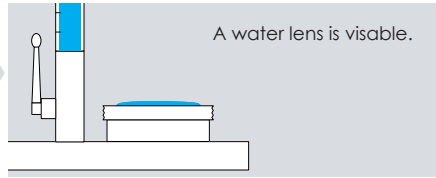

Remove burden from the sample if necessary.
Take the soil sample out of the trough and move it horizontally to the device.
Put the sample slightly tilted on the water lens, to make sure air can escape.

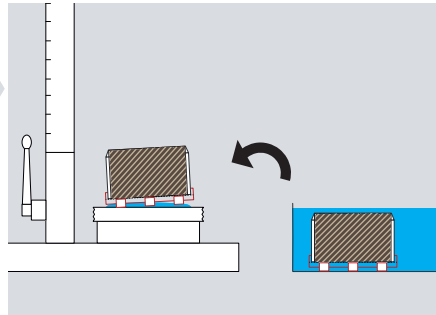

Put the upper porous plate or the mesh from the bottom into the notch of the blue gasket. Put the crown from the top onto the blue gasket.

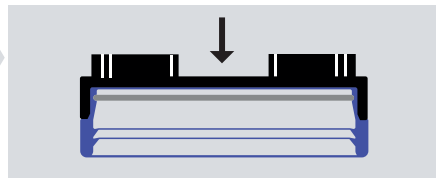

Please use mesh for consolidated materials and porous plate for non consolidated materials.

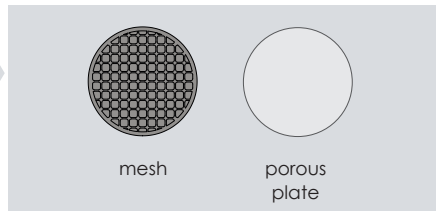

Press the whole set-up onto the sample ring in the KSAT®.

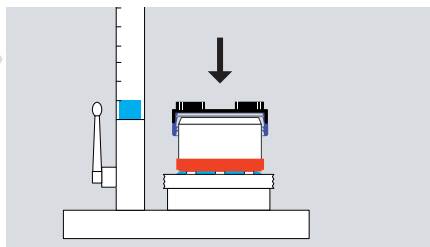

Note

If the burette cock is closed when you mount the sample the rapid pressure increase may damage the pressure sensor in the device.

Fix the set-up with the screw cap.

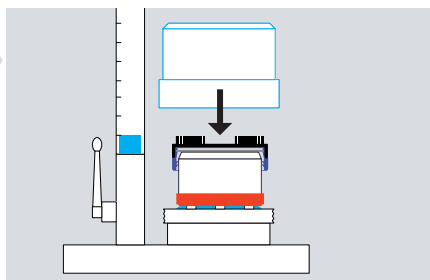

Close burette cock. Open fill cock and fill the burette.
Open burette cock again until water drains off through the discharge.
Clay samples may be "watered" (by using a filter paper to prevent a flushing of soil particles) to reduce time.
Your assembly is now ready for measurement.
Check sealing by closing the burette cock. The value "current pressure head" should not fall under zero.

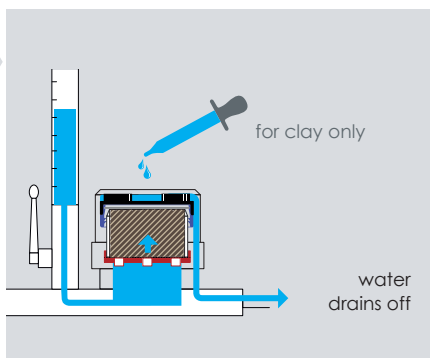

Note: burette vs screen reading

The measuring setup is tight if the meniscus is at zero after the water has drained off. The pressure reading on the screen may slightly differ by ± 0.1 cm (approx. 0.05 in).

Fill burette up to 5cm water column.

Start measurement in software.

Open burette cock.

Meaningful values of the sink rate:
from <1 mm for clayey silts to several
cm/s for highly permeable soils

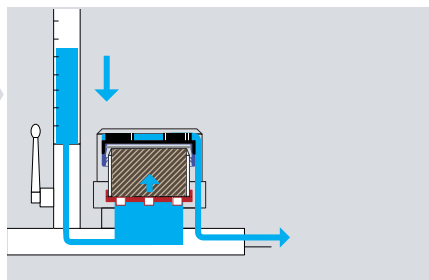

Note: Reading a meniscus in the burette correctly

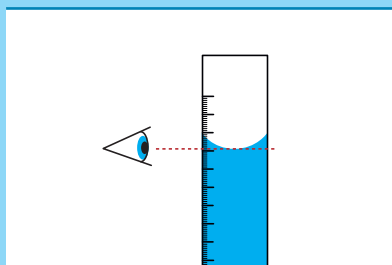

Note

Conventional tap water (preferably degassed) should be used for the measurement. For detailed information see "percolation fluid" on page 6.

How to avoid drying out the sample during long term measuring

If you measure samples with a percolation rate smaller than the evaporation in the lab (typically 0.2 to 0.5 cm/d) make sure you protect your sample from drying out. You can achieve this by covering the screw cap with a "hood" of film (e.g. PE film for food protection).

Simulating a measurement

If you want to "play" with your KSAT VIEW® software to get to know it better then use the simulation function.

- To do this, activate the checkbox "use synthetic data" in the menu "Measurements".
- In the register „Synthetic Data Parameters“ you can select the characteristic values of a measurement, such as initial water level, curvature of the falling head exponential function, statistical noise of the measurement signals, and delay time from initialization of the data recording to opening of the burette cock.
- Press start and observe the progress of the synthetic measurement.

Based on the settings you entered the software computes a curve that is shown on the screen.

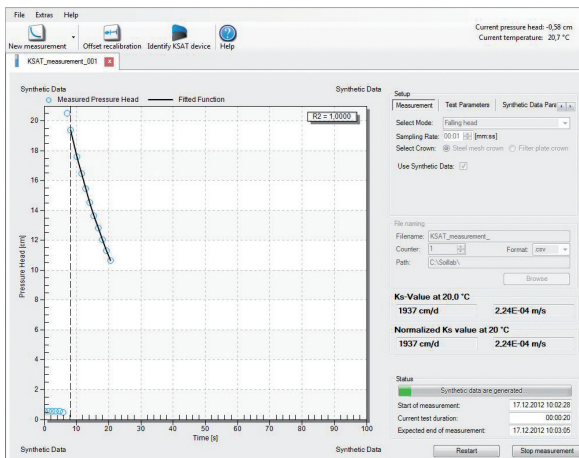

Simulating a measurement with falling head technique

Measuring with the falling head technique

The falling head mode is generally recommended as standard method. After having started, it is working fully automated without any manual readout or intervention. Historically this method was mainly used for samples with low permeability and operated with high water pressures. By measuring with the KSAT this is no longer necessary as its electronic measurement is extremely precise. For this, the method is recommended for all samples – no matter what permeability they have.

The device uses the following data to compute K_s

L	[cm]	length of the soil sample
A_{Sample}	[cm ²]	area of the soil sample
A_{Bur}	[cm ²]	burette area
H(t)	[cm]	hydraulic pressure difference at the system sample + plate

The effective conductivity of the overall system is determined by the resistance of the soil, the porous plate, resistance of connecting elements such as tubes and valves, and possibly by the contact resistance between plate and soil (normally this is not a problem under fully saturated conditions). If a plate with large pores is chosen, so that its conductivity is much higher than the soil's conductivity, the resistance in the device is negligible.

Standard measuring procedure*

The measurement starts after a click on "Start" and opening the burette cock. KSAT VIEW automatically realizes the start based on the sudden pressure increase. You can manually restart at any time by a click on the button "Restart".

By pressing the "Restart" button you can also cancel data that have been saved initially and then start again "on the run" (without stopping the water flow). This makes sense if the initial data indicate a failure or if the initial pressure increase has not been detected by the software as start signal.

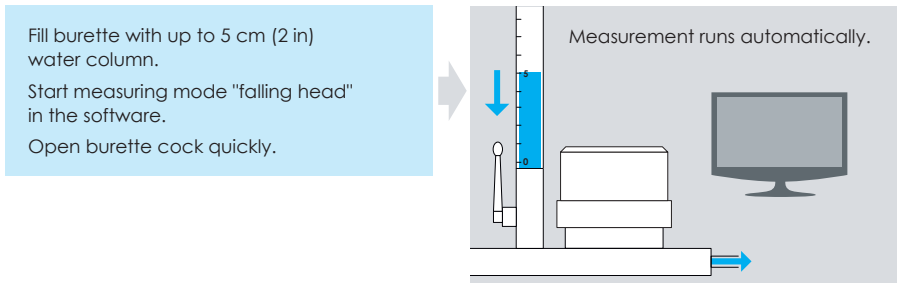

* Please find "measuring low permeability samples" on page 24.

The typical exponential curve shape.

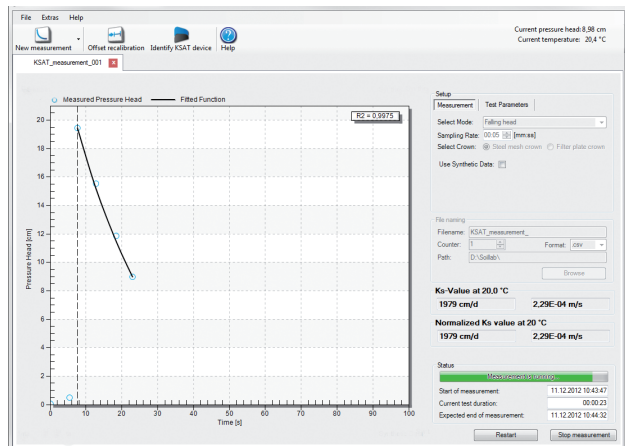

The data logged are visualized and K_s will be computed as soon as at least 2 valid data have been available. When using the falling head method there is no need to monitor the measurement. The process ends automatically when a stop criteria has been reached (see also "Configuring the device").

You can finish the measuring campaign at any time by a click on the button "Stop measuring" and then restart again.

If you start a new measurement a new tag is added on the screen. The previous data are saved and can be checked when a measurement is running.

It is usually not necessary to log data over an extended period of time or to a very low level. If the soil's conductivity is stable, you will get a stable estimate after a short time, even if the water level dropped only by 1 cm for samples with low conductivity.

In a valid measurement, the pressure head will follow an exponential decrease with time (see figure).

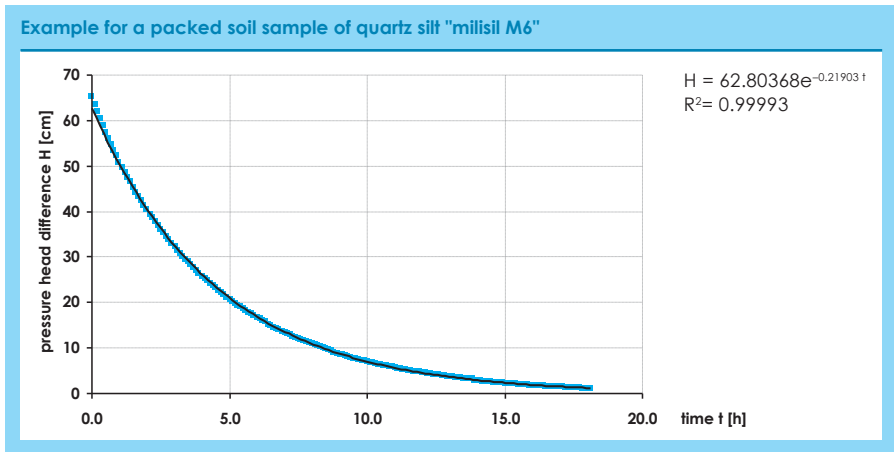

A fit with $R^2 > 0.999$ indicates a valid measurement. If the fit shows systematic deviations and a much smaller r^2 , then this has two possible reasons:

- 1) a change of the soil's conductivity during the measurement process, or
- 2) a problem with the sealing of the sample to the device.

Reasons for case 1) are discussed on page 32.

Fast measurement of samples with very low permeability

For soils with an extremely low water conductivity ($< 1 \text{ cm/d}$) you can reduce the measurement time significant by using the burette extension.

Mount the soil sample and put the gasket and the capillary tube on the burette.

Choose the measuring mode "Falling Head".

Precheck with a small overflow (5 ... 20 cm) if

- a. The soil sample is really low permeable.
- b. The soil sample is not eroded through . percolation.

Open the fill cock and raise the water level until it reaches the overflow at the upper end of the capillary tube.

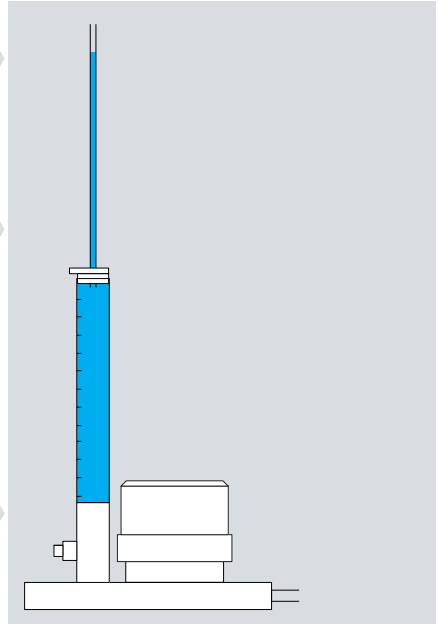

Measurement

Start falling head measurement in the software. Open burette cock.

The software automatically recognizes the higher pressure head and integrates the right parameters for calculation and evaluation.

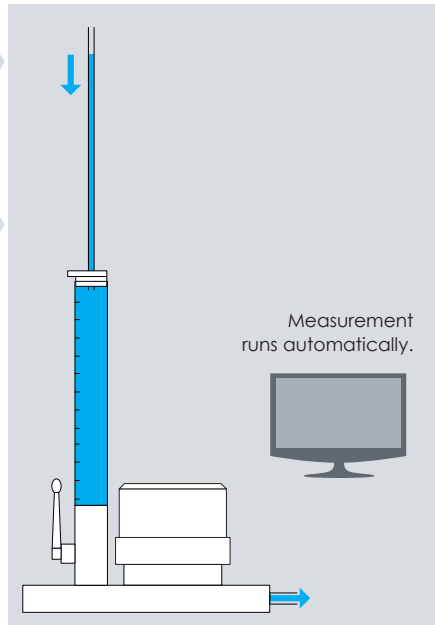

Hinweis:

For the burette extension measurement please use the new glass capillary tube (Order code: 020163) only. The burette extension method can not be performed with the old stainless steel constant head tube because of a not adequate manufactured precision of the diameter. Though the stainless steel tube can be used for constant head measurements.

Evaluation of a falling head measurement

The area-normalized actual flow rate through the soil sample results from changes to the water level in the burette

$$q = \frac{Q}{A_{\text{Sample}}} = \frac{A_{\text{Bur}}}{A_{\text{Sample}}} \cdot \frac{dH}{dt}$$

According to Darcy's law this rate equals

$$q = -K_s \cdot \frac{H}{L}$$

Equating the two and separating the variable is

$$\frac{1}{H} dH = -K_s \cdot \frac{A_{\text{Sample}}}{A_{\text{Bur}}} \cdot \frac{1}{L} \cdot dt$$

Integrating from the initial state $H = H_0$ at time $t = 0$ to time t gives

$$\ln H(t) - \ln H_0 = -K_s \cdot \frac{A_{\text{Sample}}}{A_{\text{Bur}}} \cdot \frac{1}{L} \cdot t$$

and it follows

$$H(t) = H_0 \exp\left(-K_s \cdot \frac{A_{\text{Sample}}}{A_{\text{Bur}}} \cdot \frac{1}{L} \cdot t\right) = a \exp(-b \cdot t)$$

Fitting an exponential function to the observed time series $H(t)$ determines the coefficient b . The saturated hydraulic conductivity is then given by

$$K_s = \frac{A_{\text{Bur}}}{A_{\text{Sample}}} \cdot L \cdot b$$

where	A_{Bur}	[cm ²]	cross-sectional area of the burette
	A_{Sample}	[cm ²]	cross-sectional area of the sample
	L	[cm]	length of soil sample
	t	[s]	time from "start measuring"
	H(t)	[cm]	pressure head difference at time t
	b	[1/s]	coefficient of the fitted exponential function

KSAT VIEW uses this method to calculate K_s .

Measuring with the constant head technique

Prerequisites

The setup is almost identical to the falling head technique. The only difference is putting a capillary tube (also known as capillary) and sealing cap onto the burette so that the setup works as a Mariotte flask. The water level change in the Mariotte flask allows the measurement of the cumulative volumetric inflow. It must be recorded with the help of manual readings by the operator. Thus, this measurement mode is semi-automatic.

After opening the burette cock the percolation starts. KSAT® now monitors the water pressure which is controlled by the immersion depth of the capillary tube and remains constant with time. The water level in the burette decreases linearly. The user marks with mouse clicks in KSAT VIEW at least 2 points in time when certain water levels in the burette are reached.

The measurement ends when the last water level was marked.

Note:

Because of the capillary potential (approx. 1 hPa), the pressure indicated is not 100% identical with the depth of immersion of the capillary tube.

The pressure in the Mariotte flask fluctuates slightly because of the discontinuous flow of the air bubbles. The software takes the mean.

The lowest marked water level in the burette must be above the immersion depth of the capillary tube.

Measurement

Fill burette up.

Insert capillary tube : bottom immersed into the water down to e.g. 5 cm (2 in).

Select measuring mode "constant head" in the software.

Enter water column levels you are going to read.

Press button "Start measuring" in the software.

Open burette cock quickly.

Press button "Click here" in the software when the water column passes the selected levels.

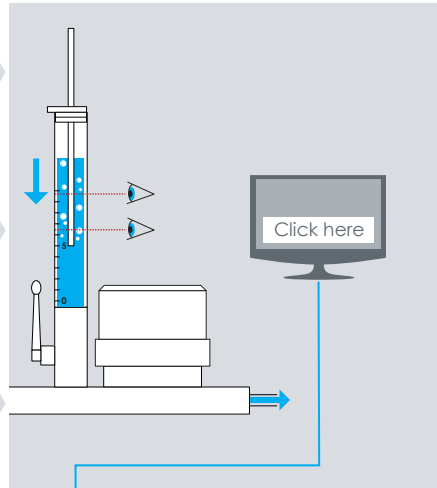

The screenshot shows the software interface for the measurement. The top menu bar includes "File", "Extras", and "Help". Below the menu bar are icons for "New measurement", "Offset recalibration", "Identify KSAT device", and "Help". The main window displays two graphs and a control panel.

Graphs:

- Top Graph:** "Synthetic Data" showing "Cumulative discharge Q [cm]" on the y-axis (0 to 0.5) and "Time [s]" on the x-axis (0 to 100). It includes "Datapoints" (open circles) and a "Percolation rate function" (solid line).
- Bottom Graph:** "Synthetic Data" showing "Pressure Head [cm]" on the y-axis (0 to 15) and "Time [s]" on the x-axis (0 to 100). It includes "Measured Pressure Head" (open circles) and a "Mean pressure head difference" (solid line).

Control Panel (Right):

- Setup:**
 - Measurement: Constant Head Steps
 - Select Mode: Constant head
 - Sampling Rate: 00:05 [mm:ss]
 - Select Crown: Steel mesh crown Filter plate crown
 - Use Synthetic Data:
- File naming:**
 - Filename: KSAT_measurement_
 - Counter: 1
 - Path: D:\Soilab\
- Ks value:** Please wait
- Normalized Ks value at 20 °C:** Please wait
- Status:** Synthetic data generated
- Start of measurement: 11.12.2012 11:05:44
- Current test duration: 00:01:04
- Expected end of measurement: ...
- Buttons: Restart, Stop measurement

Click here at 18 cm

Click here at 14 cm

Click here at 10 cm

The typical constant curve shape.

The measurement begins when you open the burette cock.

The device uses the selected pressure heads Z [cm] at the time [s] and the cumulative percolated water volume [cm³] for computation. That is why you need to press "Click here" when the water passes the selected pressure heads.

The following parameters are used

Length L [cm] and area A [cm] of the soil sample, thickness of the porous plate z [cm], constant pressure head difference H [cm] between water inlet and outlet (top of the crown).

Evaluation of a constant head measurement

To evaluate the constant head measurement, the steady-state flow rate $Q = \Delta V / \Delta t$ and the average hydraulic gradient H are determined by linear regression.

The hydraulic conductivity K_s [cm/d] at constant head is calculated by

$$K_s = \frac{Q}{A_{\text{Sample}}} \cdot \frac{L}{H}$$

where	Q	[cm ³ /d]	steady-state flow rate from Mariotte flask
	A	[cm ²]	cross-sectional area of the soil sample
	L	[cm]	length of the soil sample
	H	[cm]	hydraulic head difference between inlet and outlet level

End of a measuring campaign

A falling head measurement ends automatically when the pressure head difference reaches a stop criterion.

Stop criteria are

- falling below a relative water level compared to measurement start
- falling below a minimum water level (absolute)

You can change the default values in the menu "Test parameters". You can also stop a measurement manually when you observe the value you need has been computed with high precision and reliability. Samples with high conductivity will provide this within a few seconds.

A constant head measurement ends after you have clicked the button for all water levels you selected.

Export of data

Measured values are stored in the .csv format, which can be imported by spreadsheet programs such as MS-Excel®. Diagrams can be exported as an image in the .jpg format.

Note:

It is also possible to import a CSV-file of a finished measurement. After changing a parameter a new fitting curve can be generated by selecting "New Fitting".

Meaning of coefficients - Falling Head

Fitting Parameter a [cm]	coefficient a of the fitted exponential pressure head decrease function $y = a * \exp(-b*t)+c$, where y is the pressure head in cm and t is time in s
Fitting Parameter b [s-1]	coefficient b of the fitted exponential pressure head decrease function $y = a * \exp(-b*t)+c$, where y is the pressure head in cm and t is time in s
Fitting Parameter c [cm]	coefficient c of the fitted exponential pressure head decrease function $y = a * \exp(-b*t)+c$, where y is the pressure head in cm and t is time in s
Fitting Parameter r² [-]	coefficient of determination of the exponential pressure head decrease function that is fitted to the observed data
Ks Total [cm/d]	Saturated hydraulic conductivity [cm/d] of the entire system
Ks Total [m/s]	Saturated hydraulic conductivity [m/s] of the entire system
Ks Soil [cm/d]	Saturated hydraulic conductivity [cm/d] of the soil sample itself
Ks Soil [m/s]	Saturated hydraulic conductivity [m/s] of the soil sample itself
Ks Soil normalized at 10,0 °C [cm/d]	Saturated hydraulic conductivity [cm/d] of the soil sample normalized to 10 °C mean field temperature
Ks Soil normalized at 10,0 °C [m/s]	Saturated hydraulic conductivity [m/s] of the soil sample normalized to 10 °C mean field temperature

Meaning of coefficients - Constant Head

Water level change rate [cm/s]	Average water level decrease per time in burette during constant head percolation [cm/s]
Mean flux density [cm/s]	Volume of water per area and time that passes the sample's cross section during constant head percolation [cm ³ /(cm ² s)]
Mean pressure head [cm]	Temporal mean of water pressure head at the inlet of the sample during constant head percolation [cm]
Total system length [cm]	Total length of porous media in water percolation: equal to thickness of the inlet plate + height of sample + thickness of outlet plate (if used)
Mean pressure head gradient [-]	Difference of pressure head at inlet and outlet divided by total system length [cm/cm]

Start stop interval

On the KSAT VIEW® screen you will see the start time and the end time used for computation indicated by vertical lines.

Typical measuring results

Example sand, falling head technique

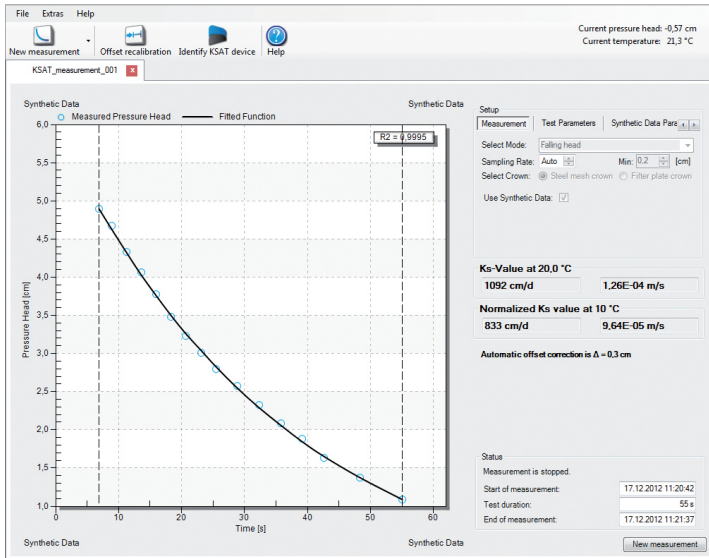

Example fine-grained soil, falling head technique

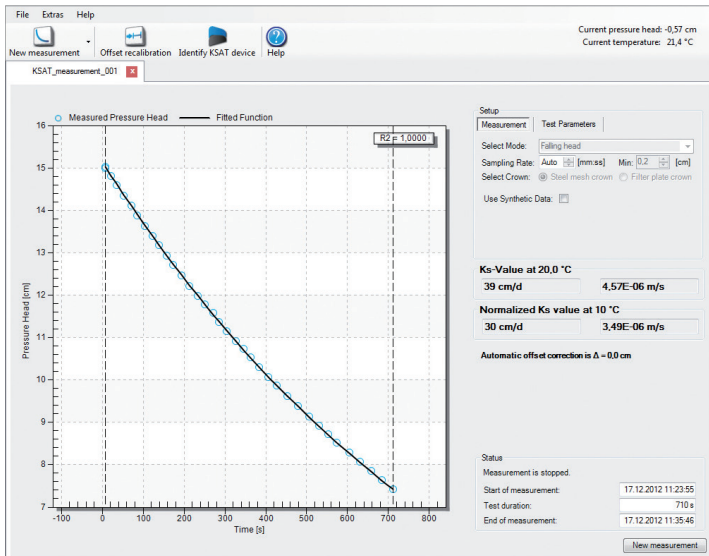

Reasons for a non-constant conductivity

Leakage of the measuring setup

Check what causes the water leakage and make sure proper sealing is achieved:

- between soil ring and ring with porous plate
- between soil ring and upper sealing

Remove screw cap, take sealing rings off and clean them.
Fix measuring setup with screw cap again.

Conductivity increases during measurement

- Sample is eroded by measuring.
- Gas bubbles dissolve at the interface between soil sample and porous plates or in the sample.
- Water temperature increases and thus its viscosity decreases.
- Turbulent flow occurs (e.g. through a macropore), and flow rate is thus not proportional to acting pressure gradient.

Conductivity decreases during measurement

- Decrease of the water ionic strength of the sample when water ionic strength has not been balanced out.
- Formation of gas bubbles either from insufficiently degassed water or from micro organisms.
- Water cools down and its viscosity increases.
- Outgassing from water generates bubble film at the interface between soil sample and the porous plates.

How to avoid trouble

Setup and environment

Wrong

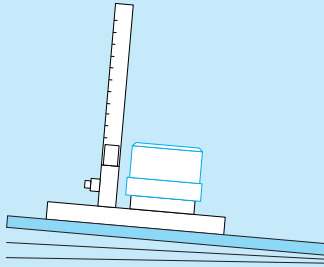

Shaky and tilted work table. Vibrations influence the measuring results.

Right

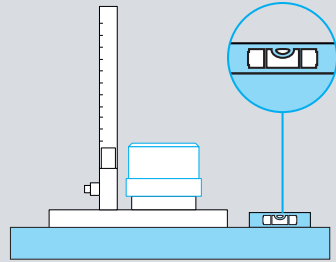

Stable, vibration-free work-table, adjusted with water level

Cleaning the measuring dome

Wrong

Do not use a sharp tool to clean the measuring dome. You may damage the **pressure sensor**.

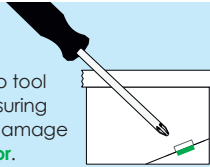

Right

Use a soft brush to clean the measuring dome.

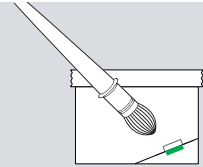

Trapped air

Wrong

trapped air between crown and soil sample

between soil sample and porous plate

below the porous plate

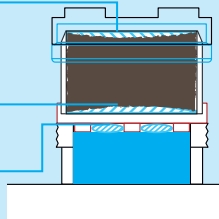

Right

crown

blue gasket

sample ring

soil sample

red gasket with porous plate

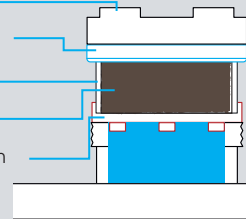

Leakage free measuring setup

Sample ring and/or sealing rings are dirty.

Clean all parts of the measuring setup especially the sample ring and the sealing rings.

Flow rates

High flow rates erode the soil sample and lead to wrong measuring results.

Air bubbles outgassing from the sample reduce the conductivity.

Extremely high flow rates cause turbulent flow and invalidate the methodology.

In general keep the hydraulic gradient low. According to DIN (German standard) the gradient for sensitive samples should be adjusted to the field properties. Usually the gradient there is <1 . This is equivalent to an initial 5 cm water column with the KSAT.

Temperature influences

A temperature raise reduces the viscosity of the measuring fluid.

E.g. increasing temperature from 20 to 23° C (68 to 73.4 F) causes a 18% change of the measuring result.

Measuring device, environment and water should have the same temperature. Keep the temperature of your lab constant.

Ion specification

Different ion composition and concentration of water and soil affect the value of the measured conductivity.

Make sure the ion composition and concentration of water and soil are similar. If necessary adjust by adding CaCl_2 .

Outgassing from water

Dissolved gases outgas and form a bubble film between the porous plate and the soil sample. They reduce the value of the measured conductivity.

Use degassed water (Boiling before measuring is ok).

Formation of gas bubbles in soil sample

Soil samples can release gas that may form bubbles in the pore system. They reduce the saturated conductivity.

Use degassed water. Saturate the soil sample under vacuum. Avoid long storage times between saturation and measurement.

Water discharge

Eroded particles from instable materials like sand may plug the discharge channel of the device.

Clean the measuring dome, remove particles and rinse thoroughly.

Installing the USB driver manually

- Connect the KSAT® device to your computer's USB port.
- Select "device manager" in the "control panel" (In Windows 2000 select the "hardware" tab first and then "device manager"). This will display a list of the devices that are connected with your computer.
- Select the METER KSAT® USB Adapter, click right on the device and then click "properties".
- In the displayed window select "driver" and then click "update driver".
- The software asks you to browse for the new driver. Select the driver "C:\Program Files (x86)\METER Group AG" or similar.
- If a warning message like : "... the hardware has not passed the Windows Logo Test ..." or a similar message appears, select: "Continue installation".
- The driver for the USB converter should now be successfully installed.

Note:

For Windows 2000/XP you need local administration rights for installation. Depending on the language of your Windows version the displayed messages may be different.

Firmware Update

- Select menu Extra "Update Firmware".
- Click .hex file
- The update runs automatically.

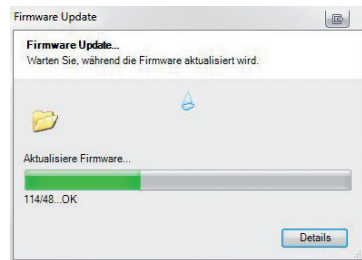
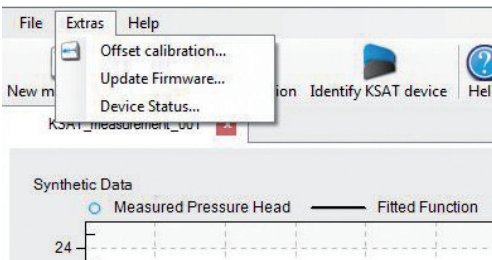

Note:

Do not disconnect device from computer. Do not shut down computer.

Cleaning and maintenance

Storage

If you do not use the device for a longer period of time please discharge it completely. Dry all parts, to avoid algae growth or mold formation.

Cleaning









Clean all surfaces with a wet cloth. Make sure water does not dry out in the device. If there are soil particles in the device clean it with a soft gush of water. If needed use a soft brush for cleaning. Then rinse the device thoroughly. Do not forget to clean the threads of the dome and the screw cap with water and a brush.

Note: Cleaning

Do not clean the device with soap, detergents or other fluids containing surfactants as surfactants change the surface tension of the water. This has a significant impact on the measuring results.

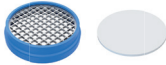
The pressure sensor can be damaged by water jets or when being touched with hard and sharp objects like screwdrivers etc.

Accessories

product / service		Details
METER soil sampling ring SZ250 for HYPROP®, KSAT® or BaPS 250 order code: 100101		volume 250 ml, outer diam. 84 mm, inner diam. 80 mm, height 50 mm incl. 2 caps
METER hammering holder SZA250 order code: 100201		for sampling rings 250 ml (with outer diam. 84 mm)
PE-Hammer order code: EJ040505		shock-free, Ø 70 mm, 2.0 kg
Transportbox for soil sampling rings order code: 100151		suitable for types SZ250 and SZ100 to protect samples during transportation
Storing tank 5 L with scale and UV protection order code: 020156		
KSAT® blue gasket with 1 each porous plate and grid order code: 020158		
KSAT® red gasket with porous foam bottom plate order code: 020159		
KSAT® wiper plate for calibration order code: 020164		
KSAT® O-Rings for burette order code: 020165		
KSAT® Saturation Plate order code: 020253		

product / service		Details
<p>METER glass capillary tube order code: 020163</p>		<p>for the burette extension measurement</p>
<p>METER Universal adapter set for 2 inches soil sampling ring order code: 020150</p>		<p>for measuring with 2 inches soil sampling rings</p>

Facts and data

Technical data

Measurable Ksat values (min.)	0.01 cm/d
Measurable Ksat values (max.)	5000 cm/d
Hydraulic conductivity Ks of the porous plate	Ks = 14000 cm/day
Typical statistical inaccuracy at constant environmental parameters and constant flow resistance of the soil	approx. 2% (in practice 10%)
Accuracy of the pressure sensor	1 Pa (0.01 cm WC)
Accuracy of the temperature sensor	± 0.3° C
Operating temperature	minimum: 15°C typical: 20°C maximum: 35°C
Sample ring (fits also with METER HYPROP®)	volume: 250 ml height 50 mm, internal diameter: 80 mm
Software required	Windows 7 and later Microsoft Framework 3.5

Intended use

The KSAT® device is suitable for measuring the hydraulic conductivity of saturated soil samples in a METER sample ring. The method is based on the German standards DIN 19683-9 and DIN 18130-1 and uses Darcy's equation. In the computation equations laminar flow is assumed and therefore they are only valid for low flow rates.

Warranty

METER offers a warranty for material and production defects for this device in accordance with the locally applicable legal provisions, but for a minimum of 12 months. The warranty does not cover damage caused by misuse, inexpert servicing or circumstances beyond our control. The warranty includes replacement or repair and packing but excludes shipping expenses. Please contact METER or our representative before returning equipment. Place of fulfillment is Mettlacher Str. 8, 81379 Munich, Germany.

Bibliography

Dane J.H. und Topp G.C. (2002)

Methods of Soil Analysis, Part 4, Physical Methods, Soil Science Society of America Book Series No. 5, ISBN 0-89118-810-X, Soil Science Society of America: Madison, p. 1692.

Darcy, Henry (1856)

Les fontaines publiques de la ville de Dijon. Dalmont, Paris.

DIN 19683-9 (1998)

Physical laboratory investigation, determination of the permeability (hydraulic conductivity) in saturated soil sample rings, Beuth Verlag GmbH.

DIN 18130 (1998)

Foundation ground: investigation of soil samples; determination of the hydraulic conductivity – part 1, Beuth Verlag GmbH.

DIN 19672-1 and E DIN ISO 10381-4

Soil quality – Sampling – Part 4: Guidance on the procedure for investigation of natural, near-natural and cultivated sites, Beuth Verlag GmbH

Dirksen C. (1999)

Soil Physics Measurements. Catena Verlag, Reiskirchen.

Hartge K.-H. und R. Horn (2009)

Die physikalische Untersuchung von Böden. 4. Auflage (Physical analysis of soils, 4th edition). E. Schweizerbartsche Verlagsbuchhandlung, Stuttgart.

McKenzie N.J., T.W. Green und D.W. Jacquier (2002)

Laboratory measurement of hydraulic conductivity. In: McKenzie et al.: Soil Physical Measurement and Interpretation for Land Evaluation. CSIRO Publ., Collingwood, Australien.

METER Group AG

Mettlacher Straße 8

81379 Munich

Tel. +49 (0) 89 / 12 66 52 - 0

Fax +49 (0) 89 / 12 66 52 - 20

environment@metergroup.de

www.metergroup.com