



Technical Specifications *

Accuracy:	< 2% of FS range under constant conditions
Analysis:	0-1%, 0-5%, 0-10%, 0-25% FS ranges: auto-ranging or fixed single range
Application:	Oxygen analysis in inert, hydrocarbon, helium, hydrogen, mixed and acid (CO ₂) gas streams
Approvals:	Certified for use in hazardous areas - see lower right UL: United States: UL 1203, UL 913, UL 508 Canada: CAN/CSA C22.2 No. 30-M1986, CAN/CSA C22.2 No. 157-92, CAN/CSA C22.2 No. 14-10 ATEX: Directive 94/9/EC
Area Classification:	Certified for use in hazardous areas - see lower right
Alarms:	Two user configurable alarms: magnetic coil relays rated 3A at 100 VAC; programmable alarm delays, alarm bypass for calibration and system fail alarm
Calibration:	Max interval—3 months. Air calibrate with clean source of certified span gas, compressed, or ambient (20.9% O ₂) air on 0-25% range.
Compensation:	Barometric pressure and temperature (ATEX) Temperature (UL)
Connections:	1/4" compression tube fittings
Controls:	Water resistant keypad; menu driven range selection, calibration and system functions
Display:	Graphical LCD 2.75" x 1.375"; resolution 0.001%; displays real time ambient temperature and pressure
Enclosure:	NEMA 3R for rain in outdoor applications (UL) NEMA 4X (ATEX)
Flow:	Not flow sensitive; recommended flow rate 1-2 SCFH
Linearity:	±1% of full scale
Pressure:	Inlet - regulate to 5-30 psig to deliver 1-2 SCFH flow; vent - atmospheric
Power:	12-28 VDC (UL and ATEX Certified) 110-220 VAC (ATEX Certified)
Response Time:	90% of final reading in < 2 minutes
Sample System:	Unique liquid drain manifold and sensor, flow indicator
Sensitivity:	< 0.5% of FS range
Sensor Model:	GPR-11-32-LD; XLT-11-24-LD for gases containing >0.5% CO ₂
Sensor Life:	24 months in air at 25°C and 1 atm
Signal Output:	4-20mA non-isolated or 1-5V; optional Modbus RTU communication
Operating Range:	-10°C to 45°C (GPR sensor); -10°C to 45°C (XLT)
Warranty:	12 months analyzer; 12 months sensor
Wetted Parts:	Stainless steel

UL or ATEX Certified for Hazardous Areas



Drains Free Liquids

GPR-2500 AIS-LD Oxygen Analyzer

**Unique Liquid Drain Sensor Manifold
Full Featured Oxygen Analyzer**

Optional Modbus RTU Communication

Exia



UL Certified
File E343386

Class I, Division 1, Groups C and D
T₄ T_{amb} -20°C to +50°C

ATEX Certified - Directive 94/9/EC
Examination Cert: INERIS 08ATEX0036



II 2 G
Ex d [ib] ib IIB T4 Gb
T_{amb} -20°C to +50°C



Optional Equipment

- Automated sample conditioning system (see other side)
- GPR-11-32-LD sensor for non-acid (CO₂) gas streams; 32 month life

* Specifications subject to change without notice

ISO 9001:2008 Certified
INTERTEK Certificate No. 485



GPR-2500 AIS LD % OXYGEN ANALYZER



Owner's Manual

Revised March 2015

Table of Contents

Introduction	1
Quality Control Certification	2
Safety	3
Features & Specifications	4
Operation	5
Maintenance	6
Spare Parts	7
Troubleshooting	8
Warranty	9
Material Safety Data Sheets	10
Explosion Proofing Electrical Connections	Appendix A

The appendices referenced above are an integral part of the documentation, installation and maintenance of this analyzer to comply with all applicable directives. It is important that users review these documents before proceeding.

1. Introduction

Your new oxygen analyzer incorporates an advanced electrochemical sensor specific to oxygen along with state-of-the-art digital electronics designed to give you years of reliable precise oxygen measurements in a variety of industrial oxygen applications. More importantly, it has been constructed as explosion proof/intrinsically safe in accordance with Safety Standards: UL 913 Seventh Edition, Referencing UL 60079-0:2005 and UL 60079-11:2009 and CSA C22.2 No. 157-92 Third Edition for use in Class I, Div 1, Groups C and D hazardous locations and the ATEX Directives 94/9/EC for zone 1 Group IIB.

Analytical Industries Inc.
dba Advanced Instruments Inc.
2855 Metropolitan Place, Pomona, CA 91767 USA

GPR-2500 AIS/2500 AIS LD



Serial No.:

Year of Manufacture:

INERIS 08ATEX0036

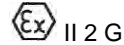

Ex d [ib] ib IIB T4 Gb

T_{amb} -20°C to +50°C



WARNING: POTENTIAL ELECTROSTATIC CHARGING HAZARD – SEE INSTRUCTIONS

Please refer to Appendix A for making electrical connections that maintains the desired level of protection.

To obtain maximum performance from your new oxygen analyzer, please read and follow the guidelines provided in this Owner's Manual.

Every effort has been made to select the most reliable state of the art materials and components, to design the analyzer for superior performance and minimal cost of ownership. This analyzer was tested thoroughly by the manufacturer prior to shipment for best performance.

However, modern electronic devices do require service from time to time. The warranty included herein plus a staff of trained professional technicians to quickly service your transmitter is your assurance that we stand behind every transmitter sold.

The serial number of this analyzer may be found on the inside the analyzer enclosure. You should note the serial number in the space provided and retains this Owner's Manual as a permanent record of your purchase, for future reference and for warranty considerations.

Serial Number: _____

Advanced Instruments Inc. appreciates your business and pledges to make every effort to maintain the highest possible quality standards with respect to product design, manufacturing and service.

2. Quality Control Certification

See analyzer packing slip/Instruction Manual that came with the analyzer for QC certificate

3. General Safety & Installation

This section summarizes the essential precautions applicable to the GPR-2500 AIS LD Oxygen Analyzer. Additional precautions specific to the individual transmitter is contained in the following sections of this manual. To operate the transmitter safely and obtain maximum performance follow the basic guidelines outlined in this Owner's Manual.



Caution: This symbol is used throughout the Owner's Manual to Caution and alert the user to recommended safety and/or operating guidelines.



Warning: This symbol is used throughout the Owner's Manual to Warn and alert the user of the presence of electrostatic discharge.



Danger: This symbol is used throughout the Owner's Manual to identify sources of immediate Danger such as the presence of hazardous voltages.

Read Instructions: Before operating the transmitter read the instructions.

Retain Instructions: The safety precautions and operating instructions found in the Owner's Manual should be retained for future reference.

Heed Warnings: Follow all warnings on the transmitter, accessories (if any) and in this Owner's Manual.

Follow Instructions: Observe all precautions and operating instructions. Failure to do so may result in personal injury or damage to the transmitter.

Analyzer label

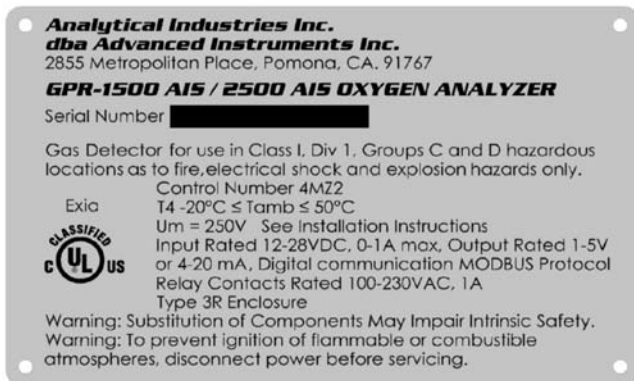

WARNING – Potential Explosion Hazard: The devices are not intended for use in atmospheres or with sample gas streams containing oxygen concentration greater than 21 percent by volume (ambient air) and are only intended for use in gases or gas mixtures classified as Class I, Div 1, Groups C and D hazardous locations or in non-hazardous locations, when used in the United States or Canada.

Maintenance

Serviceability: Except for replacing the oxygen sensor, there are no parts inside the analyzer for the operator to service. Only trained personnel with the authorization of their supervisor should conduct maintenance.

WARNING- Substitution of Components May Impair Intrinsic Safety

Oxygen Sensor: DO NOT open the sensor. The sensor contains a corrosive liquid electrolyte that could be harmful if touched or ingested, refer to the Material Safety Data Sheet contained in the Owner's Manual appendix. Avoid contact with any liquid or crystal type powder in or around the sensor or sensor housing, as either could be a form of electrolyte. Leaking sensors should be disposed of in accordance with local regulations.

Troubleshooting: Consult the guidelines in Section 8 for advice on the common operating errors before concluding that your analyzer is faulty. Do not attempt to service the analyzer beyond those means described in this Owner's Manual.

Do not attempt to make repairs by yourself as this will void the warranty as per Section 10 and may result in electrical shock, injury or damage. All other servicing should be referred to qualified service personnel.

Cleaning: The analyzer should be cleaned only as recommended by the manufacturer. Wipe off dust and dirt from the outside of the unit with a soft damp cloth then dry immediately. Do not use solvents or chemicals.

Nonuse Periods: If the analyzer is equipped with a range switch advance the switch to the OFF position and disconnect the power when the transmitter is left unused for a long period of time.

Installation

This analyzer has been constructed in compliance with:

EN 60079-0 : 2009

EN 60079-1 : 2007

EN 60079-11 : 2012

For USA and Canada

UL 913, 7th Edition

CSA C22.2 No. 157-92

It must be installed in accordance with :

EN 60079-14

For USA - NEC and Canada – CEC Standards

WARNING - Potential Explosion Hazard – See Warning in Section 4 – Features and Specifications

Gas Sample Stream: Ensure the gas stream composition of the application is consistent with the specifications and if in doubt, review the application and consult the factory before initiating the installation. **Note:** In natural gas applications such as extraction and transmission, a low voltage current is applied to the pipeline itself to inhibit corrosion of the pipeline. As a result, electronic devices connected to the pipeline can be affected unless they are adequately grounded.

Contaminant Gases: A gas scrubber and flow indicator with integral metering valve are required upstream of the analyzer to remove any interfering gases such as oxides of sulfur and nitrogen or hydrogen sulfide that can interfere with measurement and cause reduction in the expected life of the sensor. Consult the factory for recommendations concerning the proper selection and installation of components.

Expected Sensor Life: With reference to the publish specification, the expected life of all oxygen sensors is predicated on the basis of typical oxygen concentration (air for % sensor), temperature (77°F/25°C) and pressure (1 atmosphere) in

“normal” applications. Deviations from standard conditions will affect the life of the sensor. As a rule of thumb, sensor life is inversely proportional to changes in the pressure and temperature.

Accuracy & Calibration: Refer to section 5 Operation.

Materials: Assemble the necessary zero, sample and span gases and optional components such as valves, coalescing or particulate filters, and pumps as dictated by the application. Stainless steel tubing is essential for maintaining the integrity of the gas stream for low % level analysis.

Operating Temperature: The sample must be sufficiently cooled before it enters the analyzer and any optional components. A coiled 10 foot length of ¼” stainless steel tubing is sufficient for cooling sample gases as high as 1,800 °F to ambient. The recommended operating temperature is below 35 °C. However, the analyzer may be operated at temperature up to 45 °C on an intermittent basis but the user is expected to accept a reduction in expected sensor life –as a rule of thumb, for every degree °C increase in temperature (above 25 °C), the sensor life is reduced by approximately 2.5%.



Warning – Sample Stream entering unit must never exceed 50 °C

Heat: Situate and store the analyzer away from direct sources of heat.

Liquid and Object Entry: The analyzer should not be immersed in any liquid. Care should be taken so that liquids are not spilled into and objects do not fall into the inside of the analyzer.

Handling: Do not use force when using the switches, knobs or other mechanical components. Before moving your analyzer be sure to disconnect the wiring/power cord and any cables connected to the output terminals of the analyzer.

Sample Pressure and Flow

All electrochemical oxygen sensors respond to partial pressure changes in oxygen. The sensors are equally capable of analyzing the oxygen content of a flowing sample gas stream or monitoring the oxygen concentration in ambient air (such as a confined space in a control room or an open area around a landfill or bio-pond). The following is applicable to analyzers equipped with fuel cell type oxygen sensors.

Inlet Pressure: For the analyzers designed to measure oxygen in a flowing gas stream, the inlet sample pressure must be regulated between 5-30 psig. Although the rating of the SS tubing and tube fittings/valves itself is considerably higher (more than 100 psig), a sample pressure of 5-30 psig is recommended for ease of control of sample flow.

The analyzer equipped with a sample system has designated SAMPLE and VENT ports. Connect SAMPLE gas to SAMPLE and the vent to the VENT ports only.

Outlet Pressure: In applications where sample pressure is positive, the sample must be vented to an exhaust pipe at a pressure less than the inlet pressure so that the sample gas can flow through the sensor housing. Ideally, the sample must be vented to atmospheric pressure.

Note: The sensor may be used at a slight positive pressure (e.g., when sample is vented to a common exhaust where the pressure might be higher than 1 atmosphere). However, the pressure at the sensor must be maintained at all times including during the span calibration. This may be accomplished by using a back-pressure regulator at vent line of the analyzer. The back-pressure regulated must be set less than 2 PSIG. For higher back-pressure requirements, consult factory.

Caution: A sudden change in pressure at the sensor may result in the sensor electrolyte leakage.

Flow rates of 1-5 SCFH cause no appreciable change in the oxygen reading. However, flow rates above 5 SCFH may generate a slight backpressure on the sensor resulting in erroneous oxygen readings.

Caution: Do not place your finger over the vent (it pressurizes the sensor) to test the flow indicator when gas is flowing to the sensor. Removing your finger (the restriction) generates a vacuum on the sensor and may damage the sensor (voiding the sensor warranty).

Application Pressure - Positive: A flow indicator with integral metering valve positioned upstream of the sensor is recommended for controlling the sample flow rate between 1-2 SCFH. If necessary, a pressure regulator upstream of the

flow control valve should be used to regulate the inlet pressure between 5-30 psig. Though the analyzer is designed to handle inlet pressure up to 100 PSIG, 5-30 PSIG pressure range is recommended only for ease of control of sample flow.

Application Pressure - Atmospheric or Slightly Negative: For % oxygen measurements, an optional external sample pump may be used upstream of the sensor to push the sample across the sensor and out to atmosphere or an eductor pump downstream of the sensor to pull the sample across the sensor. If the sample pump can pull/push more than 5 SCFH, a flow meter with control valve must be used to control the sample flow. The flow control valve must be positioned in such a way that it does not generate any vacuum on the sensor.



Caution: If the analyzer is equipped with a flow indicator with integral metering valve or a metering flow control valve upstream of the sensor and the pump is installed downstream of sensor- open the metering valve completely before turning the pump ON to avoid drawing a vacuum on the sensor and placing an undue burden on the pump.

Mounting: The analyzer is approved for indoor as well as outdoor use. However, avoid mounting in an area where direct sun might heat up the analyzer beyond the recommended operating temperature range. If possible, install a small hood over the analyzer for rain water drain and to prevent over-heating of analyzer. **If the ambient temperature is expected to fall below -18 degree C (0 degree F), install the analyzer within an heated enclosure.**

Gas Connections: The Inlet and outlet vent gas lines require 1/8" or 1/4" stainless steel compression type tube fittings. The sample inlet tubing must be metallic, preferably SS. The sample vent line may be of SS or hard plastic tubing with low gas permeability.

Power: Supply power to the analyzer only as rated by the specification or markings on the analyzer enclosure. The GPR-2500 AIS LD is powered by 12-28 VDC supply. The wiring that connects the analyzer to the power source should be installed in accordance with recognized electrical standards. Ensure that the analyzer case is properly grounded and meets the requirements for area classification where the analyzer is installed. Never yank wiring to remove it from a terminal connection.

The maximum power the analyzer consumes is no more than 7 Watts.

4. Features & Specifications



Advanced Instruments Inc.

Technical Specifications *

Accuracy: < 2% of FS range under constant conditions

Analysis: 0-1%, 0-5%, 0-10%, 0-25% FS ranges; auto-ranging or fixed single range

Application: Oxygen analysis in natural gas, inert, hydrocarbon, helium, hydrogen, mixed and acid (CO₂) gas streams

Approvals: Certified for use in hazardous areas - see lower right
UL: United States: UL 1203, UL 913, UL 508
 Canada: CAN/CSA C22.2 No. 30-M1986, CAN/CSA C22.2 No. 157-92, CAN/CSA C22.2 No. 14-10
ATEX: Directive 94/9/EC

Area Classification: Certified for use in hazardous areas - see lower right

Alarms: Two user configurable alarms: magnetic coil relays rated 3A at 100 VAC, programmable alarm delays, alarm bypass for calibration and system fail alarm

Calibration: 3 month interval using air or certified span gas with O₂ value approx 80% of full scale range balance N₂

Compensation: Barometric pressure and temperature

Connections: 1/4" compression tube fittings

Controls: Water resistant keypad; menu driven range selection, calibration and system functions

Display: Graphical LCD 2.75" x 1.375"; resolution 0.001%; displays real time ambient temperature and pressure

Enclosure: NEMA 3R suitable for rain in outdoor applications

Flow: Not flow sensitive; recommended flow rate 1-2 SCFH

Linearity: ±1% of full scale

Pressure: Inlet - regulate to 5-30 psig to deliver 1-2 SCFH flow; vent - atmospheric

Power: 18-28 VDC (UL and ATEX Certified)
110-220 VAC (ATEX Certified)

Response Time: 90% of final reading in < 2 minutes

Sample System: Unique liquid drain manifold and sensor, flow indicator

Sensitivity: < 0.5% of FS range

Sensor Model: XLT-11-24-LD; optional GPR-11-32-LD (see below)

Sensor Life: 24 months in air at 25°C and 1 atm

Signal Output: 4-20mA; optional 1-5V DC, Modbus Communication

Operating Range: -10°C to +45°C

Warranty: 12 months analyzer; 12 months sensor

Wetted Parts: Stainless steel

Optional Equipment

Power, output and sensor above: Heater, NEMA 4x enclosure for outdoors

GPR-11-32-LD sensor for non-acid (CO₂) gas streams; 32 month life

*Specifications subject to change without notice

UL or ATEX Certified
Oxygen Analysis in Hazardous Areas

Drains Free Liquids to Ensure Reliability, Maximize Production & Minimize Maintenance



GPR-2500 A15-LD Oxygen Analyzer

Exia

CLASSIFIED
 **UL Certified**
 File E343386

Class I, Division 1, Groups C and D
 T4 T_{amb} -20°C to +50°C

ATEX Certified - Directive 94/9/EC
 Examination Cert: INERIS 08ATEX0036

 II 2 G
 Ex d [ib] IIB T4
 T_{amb} -20°C to +50°C

 0080

ISO 9001:2008 Certified
INTERTEK Certificate No. 485



2855 Metropolitan Place, Pomona, CA 91767 USA ♦ Tel: 909-392-6900, Fax: 909-392-3665, www.a1i1.com, e-mail: info@a1i1.com Rev 3/15

5. Operation

Principle of Operation

The GPR-2500 AIS LD Oxygen Analyzer incorporates the GPR-11-32-LD or XLT-11-24-LD advanced galvanic fuel cell type oxygen sensors. These sensors are very specific to oxygen and generate an electrical signal proportional to the amount of oxygen present in a gas stream. The selection of a particular type of sensor depends on the composition of the sample gas stream. Consult factory for recommendation.

The analyzer is configured in two sections. The signal processing electronics and sensor are housed in a general purpose NEMA 4X rated enclosure. The terminals for incoming power, signal output and intrinsic safety barriers are mounted on a PCB housed in an explosion proof enclosure.

The two sets of electronics are interconnected using an explosion proof Y-fitting, explosion proof packing fiber and sealing cement – see Appendix A. Once connected, the intrinsic safety barriers limit the amount of power that flows to and from the signal processing electronics effectively preventing an explosive condition. The analyzer design conforms to the ATEX and UL directive for equipment as intrinsically safe and has been approved by an independent body:

The analyzer carries the following area classification



II 2 G

Ex d [ib] ib IIB T4 Gb

T_{amb} -20°C to +50°C



WARNING: POTENTIAL ELECTROSTATIC CHARGING HAZARD-SEE INSTRUCTION

For USA and Canada
UL 913, 7th Edition
CSA C22.2 No. 157-92

It must be installed in accordance with
EN 60079-14
For USA - NEC and Canada – CEC Standards

The GPR-2500 AIS also meets the intrinsic safety standards required for use in Class I, Division 1, Groups C, D hazardous areas.

Advanced Galvanic Sensor Technology

All galvanic type sensors function on the same principle and are specific to oxygen. They measure the partial pressure of oxygen from low PPM to 100% levels in inert gases, gaseous hydrocarbons, helium, hydrogen and mixed gases.

Oxygen, the fuel for this electrochemical transducer, diffusing into the sensor, reacts electrochemically at the sensing electrode to produce an electrical current output proportional to the oxygen concentration in the gas phase. The sensor's signal output is linear over all measuring ranges and remains virtually constant over its useful life. The sensor requires no maintenance and is easily and safely replaced at the end of its useful life.

Proprietary advancements in design and chemistry add significant advantages to this extremely versatile oxygen sensing technology. Sensors recover from air to low % levels in seconds, exhibit longer life and reliable quality. The expected life of our new generation of percentage range sensors now range from 32 months to ten years with faster response times

and greater stability. Another significant development involves expanding the operating temperature range for percentage range sensors from -20°C to 50°C. Contact factory for more specific information about your application.

NOTE- Check the product label for safe operating conditions

Electronics

The signal generated by the sensor is processed by state of the art low power micro-processor based digital circuitry. The first stage amplifies the signal. The second stage eliminates the low frequency noise. The third stage employs a high frequency filter and compensates for signal output variations caused by ambient temperature changes. The result is a very stable signal. Sample oxygen is analyzed very accurately. Response time of 90% of full scale is less than 2 minutes (actual experience may vary due to the integrity of sample line connections, dead volume and flow rate selected) on all ranges under ambient monitoring conditions. Sensitivity is typically 0.5% of full scale of the low range. Oxygen readings may be recorded by an external device via the 4-20 mA or 1-5V signal output.

Sample System

See Section 4, Features and Specification, Note 1 for exclusions.

The standard GPR-2500 AIS-LD is supplied with a sample flow-through sensor housing that allows the moisture/condensable liquids to separate when the sample enters the sensor housing thus providing the user with hassle free sample analysis despite the presence of liquid in the sample gas; see section 2 QC Certification for additional optional equipment ordered.

The GPR-2500 AIS-LD is generally supplied with a sample flow control valve and a flow meter and sample/span selection valve. Users interested in adding their own sample conditioning system should consult factory. Advanced Instruments Inc. offers a full range of sample handling, conditioning and expertise to meet your application requirements. Contact us at 909-392-6900 or e-mail us at info@aii1.com.

Calibration & Accuracy Overview

Single Point Calibration: As previously described the galvanic type oxygen sensor generates an electrical current proportional to the oxygen concentration in the sample gas. In the absence of oxygen the sensor exhibits an absolute zero, e.g. the sensor does not generate a current output in the absence of oxygen. Given these linearity and absolute zero properties, single point calibration is possible.

Pressure: Because sensors are sensitive to the partial pressure of oxygen in the sample gas, their output is a function of the number of molecules of oxygen 'per unit volume'. Readouts in percent are permissible only when the total pressure of the sample gas being analyzed remains constant. The pressure of the sample gas and that of the calibration gas must be the same.

Temperature: The rate at which oxygen molecules diffuse into the sensor is controlled by a Teflon membrane otherwise known as an 'oxygen diffusion limiting barrier' and all diffusion processes are temperature sensitive, the fact the sensor's electrical output will vary with temperature is normal. This variation is relatively constant (2.5% per °C). A temperature compensation circuit employing a thermistor and a network of resistors offsets this effect with an accuracy of $\pm 5\%$ or better over a wide operating temperature range e.g., 5-45 °C can be obtained thus the signal output remains virtually independent of ambient temperature. There is extremely

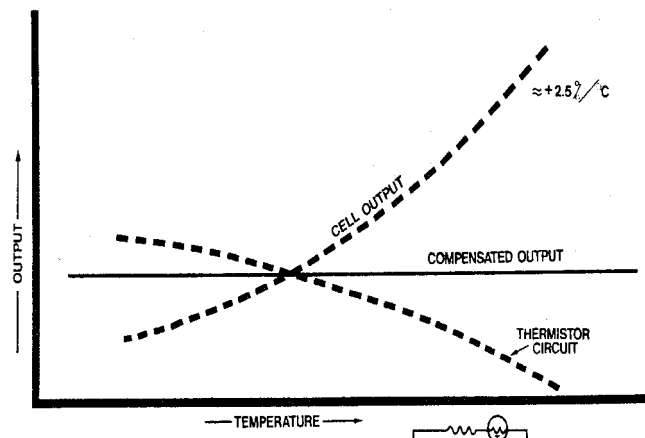

low error in measurement if the calibration and sampling are performed at similar temperatures (within +/- 5 °C. Conversely, a temperature variation of 10 °C may produce an error of < 2% of full scale.

Accuracy: In light of the above parameters, the overall accuracy of an analyzer is affected by two types of errors: 1) 'percent of reading errors', illustrated by Graph A below, is contributed by the temperature compensation circuit (tolerance in the thermistor value, variation in temperature coefficient of the thermistor, tolerances in resistors values and the accuracy in the measuring devices, e.g., LCD display and 2) 'percent of full scale errors', illustrated by Graph B, such as 1-2% offset errors in readout and calibration devices. Other errors are 'spanned out' during calibration, especially when analyzer is calibrated close to the top end of the measuring range.

Graph C illustrates these 'worse case' specifications that are typically used to develop an overall accuracy statement of < 1% of full scale at constant temperature or < 5% over the operating temperature range. The QC testing error is typically < 0.5% prior to shipment of analyzer from the factory.

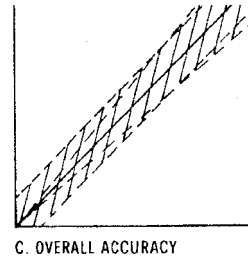
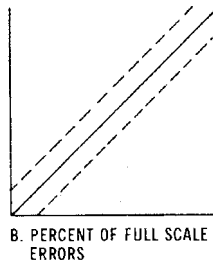
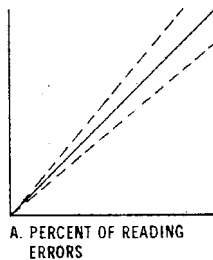

Example 1: As illustrated by Graph A, any error during a span adjustment at lower end of the scale, e.g., 20.9% (air) on a 100% full scale range, would be multiplied by a factor of 4.78 ($100/20.9$) when making measurements close to 100% O₂. Conversely, an error during a span adjustment close to the top end of the range, e.g., at 100% is reduced proportionately for measurements of oxygen concentrations near the bottom end of the range.

Graph B represents a constant error over the entire measuring range. This error is generally associated with the measuring e.g., LCD and or calibrating devices, e.g., current simulator or current/voltage measuring devices.

Potential Explosion Hazard – See warning in Section 4 – Features and Specifications

Mounting the Transmitter

The GPR-2500 AIS-LD analyzer consists of two interconnected enclosures. This configuration is designed to be mounted directly to any flat vertical surface, wall or bulkhead plate by using four (4) of the appropriate mounting holes on the back panel.

To facilitate servicing the interior of the transmitters, secure the back plate to a vertical surface approximately 5 feet from the floor or a level accessible to service personnel. This requires the user to supply four (4) additional proper size screws and anchors.



Caution: Do not remove or discard the gaskets from either the Ex enclosure or the fiberglass enclosure. Failure to reinstall either of the gaskets will void the NEMA 4, UL Type 3R rating and the immunity to RFI/EMI.

The transmitters design provides immunity from RFI/EMI by maintaining a good conductive contact between the two sections of the enclosures containing the main electronic signal processing PCB/display via a conductive gasket (the smaller enclosure inside the fiber glass enclosure) The surfaces contacting the conductive gasket are unpainted. Do not paint these areas. Painting will negate the RFI/EMI protection.

Note: The transmitter and sample system are mounted to a back panel 15-3/4"H x 15-3/4"W with four mounting holes. Mount the entire panel to any vertical flat surface.



Gas Connections

The GPR-2500 AIS-LD with its standard flow through configuration is designed for positive pressure samples and requires connections for incoming sample and outgoing vent lines. A span inlet port is offered as part of the sample system. The user is responsible for calibration gases and other required components, see below.

Procedure

Caution: Do not change the factory setting until instructed to do in this manual.

1. Regulate the sample pressure as described in "Pressure and Flow" section above.
2. Connect a ¼" vent line to the compression fitting to be used for venting the sample.
3. Connect a ¼" sample line to the compression fitting marked SAMPLE on the analyzer.
4. Connect the SPAN gas lines to the SPAN port of the analyzer.
5. Set the SAMPLE and SPAN gas pressure between 5-30 psig. **Set the Sample and Span pressure within 5 PSIG to ensure a relatively constant flow when switching Sample/Span gases**
6. Use the span gas to set the flow rate for the sample as well by setting the three-way Sensor/ Flow Meter Span Bypass valve to Flow Meter/Span Bypass and set the flow rate to 1- 2 SCFH. Do not use the sample containing liquid to set the flow rate as liquid can damage the flow meter.
7. After setting the flow rate, switch the Sensor/ Flow Meter Span Bypass valve to Sensor and Sample/Span valve to Sample or Span.

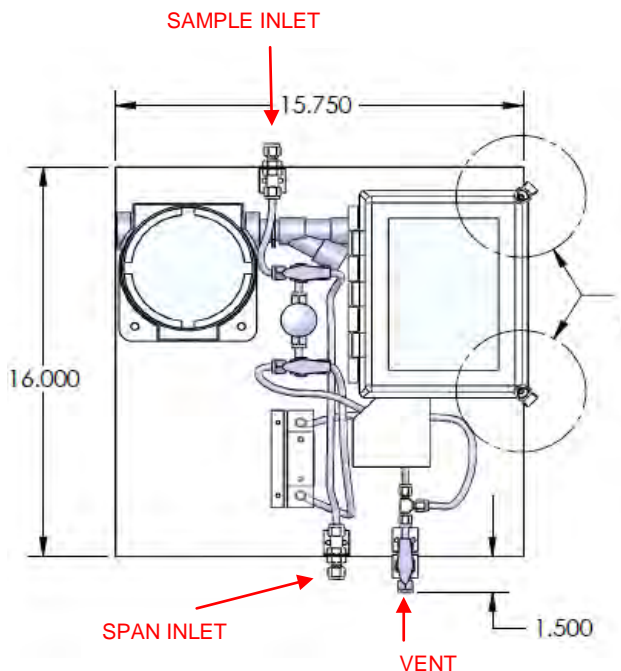

Picture View of Two Valve Configuration

Electrical Connections



Incoming power/signal output connections are made to terminal block mounted on a PCB located in the explosion proof enclosure.

Do not supply voltage more than specified in this manual and noted near the power input terminal of the analyzer.

The PCB in the explosion proof enclosure contains a power limiting intrinsic safety barrier that limit the total power available at the PCB electronics mounted in the general purpose enclosure.

With proper insulation of the incoming power (see Appendix A), this configuration of the GPR-2500 AIS-LD conforms to the ATEX directives for equipments for use in hazardous area. The analyzer meets the following area classification:



II 2 G

Ex d [ib] ib IIB T4 Gb

T_{amb} -20°C to +50°C



The GPR-2500 AIS-LD also meets the intrinsic safety standards required for use in Class I, Division 1, Group C, D hazardous areas.

UL 913 Seventh Edition, Referencing UL 60079-0:2005 and UL 60079-11:2009 and CSA C22.2 No. 157-92 Third Edition for use in Class I, Div 1, Groups C and D hazardous locations

The A-1166 AIS PCB in the Ex enclosure contains four safety fuses and one plug-in (brown color) rated at 200 mA, The safety fuses meet barrier network standard EN 50020.



Avoid electrostatic discharge – Clean all surfaces with a damp cloth only.



Analyzer ground terminal must be connected to a ground



Hazardous Area Installation

The GPR-2500 AIS-LD may be installed in a hazardous area with proper insulation of the incoming power, see Appendix A. A 12-28 VDC power supply with a shielded power cable is recommended. The power cable to the Ex enclosure must be supplied through a conduit approved for use in hazardous area. Secure the wires to the power input terminal block by using the integral screws of the terminal block. Do not substitute terminal screws.



CAUTION: Check the QC and the analyzer label for the proper power requirement. Incorrect power will severely damage the analyzer

Power In/Signal Output Connections

The analyzer has one terminal for power in and 4-20 mA loop connections.

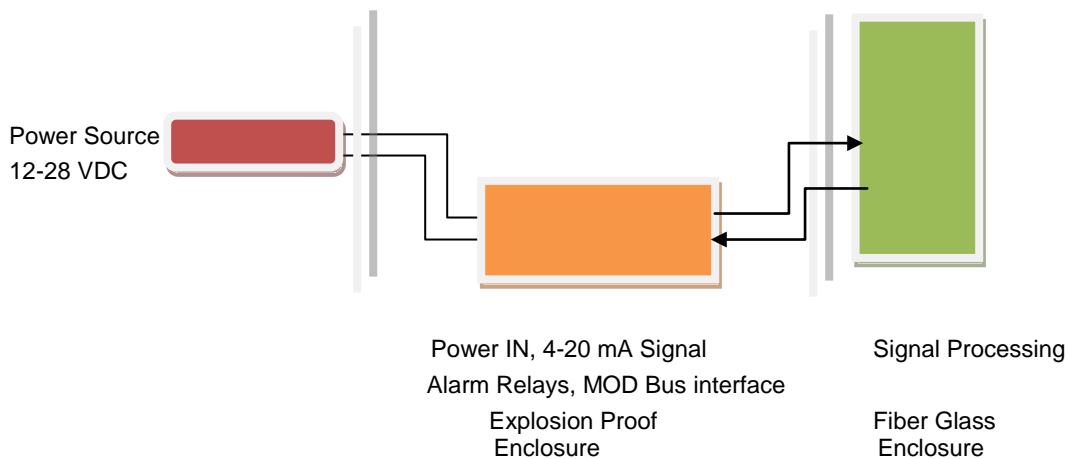

NOTE: There are five interconnecting wires between the explosion proof enclosure and the fiber glass enclosure, for Clarity, only two wires are shown.

Procedure

Power requirements consist of a 12-28 VDC power supply.

1. Unscrew the cone shaped cover from the Ex enclosure.
2. Strip the end of wires no greater than 1/4 inch
3. Loosen the two screws of the terminal block. Insert the stripped end of the wires into the terminal block. Ensure the positive and negative terminals of the power cable are connected to the terminals of the terminal block as marked.
4. Connect the Ground to the ground screw outside the enclosure.
5. Replace the cover.

Installing the Oxygen Sensor

The GPR-2500 AIS-LD Oxygen Analyzer is equipped with a SS flow-through sensor housing. This housing offers ease of replacement of sensor. The sensor simply screws into the sensor flow-through adaptor. After screwing the sensor into the housing, remove the Molex connector on top of the sensor and connect the sensor cable to the sensor.



Caution: All analyzers must be calibrated once the installation has been completed and periodically thereafter as described below. Following the initial installation and calibration, allow the transmitters to stabilize for 12-24 hours and re-calibrate the transmitter with a certified span gas.



Caution: DO NOT dissect the oxygen sensor. The sensor contains a corrosive liquid electrolyte that could be harmful if touched or ingested, refer to the Material Safety Data Sheet contained in the Owner's Manual appendix. Avoid contact with any liquid or crystal type powder in or around the sensor or sensor housing, as either could be a form of electrolyte. Leaking sensors should be disposed off in a manner similar to that of a common battery in accordance with local regulations.



Avoid electrostatic discharge – Clean all surfaces with a damp cloth only.



Procedure

1. Remove the two (2) clamps securing the right side corners and open the door of the fiber glass enclosure.
2. Remove the sensor cable from the sensor (if the sensor has been previously installed)
3. Remove the old sensor (if previously installed) from the sensor housing
4. Remove the oxygen sensor from the bag.
5. Immediately screw the sensor into the sensor flow through adaptor.
6. Remove the Molex connector with red shorting wire from the sensor
7. Connect the sensor cable to the sensor
8. You may choose the option to "air calibrate" the sensor at this time (see details in "calibration") to ensure that the analyzer accepts the air calibration and that the sensor output is within the recommended limits.
9. The analyzer electronics will respond immediately and display the oxygen contents (in air or flowing sample)
10. The sensor will trend down from air to low PPM levels within a few minutes.
11. Allow sensor to stabilize for a few hours and re-check the calibration with a span gas if required.

Span Gas Preparation

See Section 4 – Features and Specifications, for exclusions if any

Note: The GPR-2500 AIS-LD can be calibrated by using ambient air. However, it can also be calibrated by using a certified span gas. Air calibration can be achieved right after installing the sensor in the housing. Subsequent calibration, where the sensor has been exposed to a sample gas, air calibration can be achieved by either removing the sensor from the sensor housing or by pushing the air through the sensor housing.



Caution: Do not contaminate the span gas cylinder when installing the pressure regulator on the span gas cylinder. Further, bleed the air filled regulator and span gas tubing before connecting the span gas to the analyzer and attempting the initial calibration. A three way purge valve is highly recommended to purge the span line before allowing the span gas to flow through the sensor housing.

Required Components

1. Certified span gas cylinder or compressed air with an oxygen concentration, balance nitrogen, approximating 80% of the full scale of the measuring range or one range above the intended measuring range.
2. A pressure regulator to set the span gas pressure between 5-30 psig (set Span gas pressure with 2 PSIG of the Sample gas to ensure relatively constant flow when switching from Sample/Span and vise-versa).
3. Suitable tube fittings and a 4-6 ft. length of metal tubing to connect the pressure regulator to the analyzer Span inlet
4. A three way valve to purge the Span gas line before allowing the span gas to enter the sensor housing.

Procedure

1. With the span gas cylinder valve closed, install the pressure regulator on the cylinder.
2. Open the regulator's exit valve and partially open the pressure regulator's control knob.
3. Open slightly the cylinder valve.
4. Loosen the nut connecting the regulator to the cylinder and bleed the pressure regulator.
5. Retighten the nut connecting the regulator to the cylinder
6. Adjust the regulator exit valve and slowly bleed the pressure regulator.
7. Open the cylinder valve completely.
8. Set the pressure between 5-30 psig using the pressure regulator's control knob. The Span gas pressure should be within 2 PSIG of the Sample pressure to ensure that when switching Span to Sample, the flow rate will be very similar to that with Span gas.

Establishing Power to Electronics

Once power is supplied to the power terminals inside the Ex enclosure as described above, the digital display responds instantaneously and performs several self-diagnostic system status checks termed as "START-UP TEST" as illustrated below:

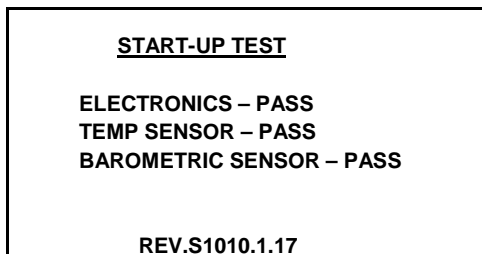

After self diagnostic tests, the analyzer turns itself into the sampling mode. And displays oxygen contents the sensor is exposed to, the analysis range, the ambient temperature and pressure.

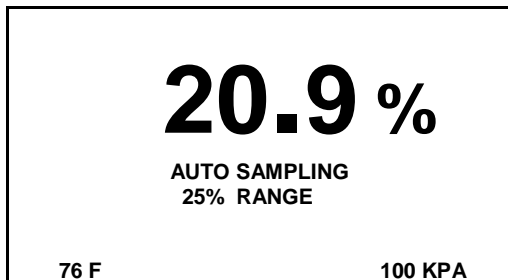

Menu Navigation

The four (4) pushbuttons located on the front of the transmitter control the micro-processor functions:

Blue ENTER (select)

Yellow UP ARROW

Yellow DOWN ARROW

Green MENU (escape)

Main Menu

To access the MAIN MENU, press the MENU (ESC) key and the following screen will appear.

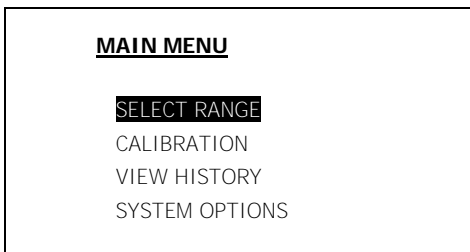

This screen show various option available. You can use the UP and DOWN arrow key to move the cursor and highlight the desired function. After moving the cursor to the desired function, you can press ENTER to get to that function.

Range Selection

The GPR-2500 AIS-LD transmitter is equipped with four (4) standard measuring ranges (see specification) and provides users with a choice of sampling modes. By accessing the MAIN MENU, users may select either the AUTO SAMPLING (ranging) or MANUAL SAMPLING (to lock on a single range) mode.

Auto/ Manual Sampling

Access the MAIN MENU by pressing the MENU key.

Advance the reverse shade cursor using the ARROW keys to highlight SELECT RANGE and press ENTER

The display will show *AUTO and the actual range of analysis. Press the ENTER to select MANUAL RANGE and advance the cursor to the desired RANGE and press ENTER or press ESC to stay in AUTO RANGE mode.

The following display appears:

The display returns to the sampling mode:

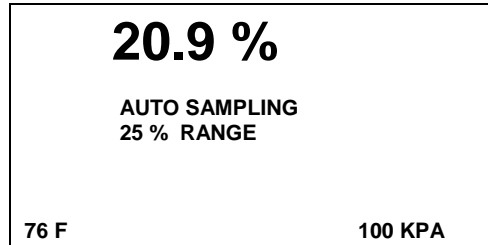
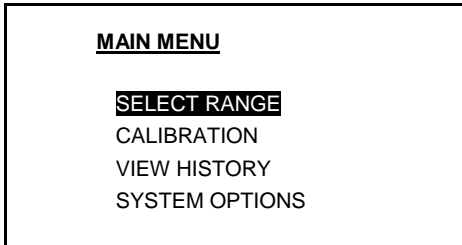

With AUTO RANGE option, the display will shift to the next higher range when the oxygen reading exceeds 99.9% of the upper limit of the current range. The display will shift to the next lower range when the oxygen reading drops to 15% of the current range.

Pressing SELECT RANGE and then pressing ENTER will toggle between AUTO and MANUAL sampling

NOTE: When MANUAL range is selected and If oxygen value goes above the selected range, display will not shift to the next higher range. Instead, when oxygen reading exceeds 110% of the upper limit of the current range, an OVER RANGE warning will be displayed.

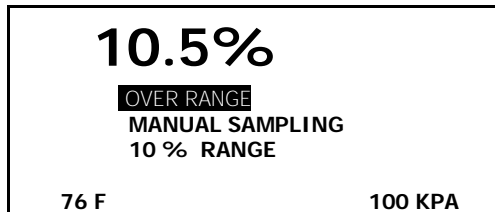

Once the OVER RANGE warning appears the user must advance the transmitter to the next higher range.

NOTE: With oxygen reading above 110% of the selected range, the mA signal output will increase but will freeze at a maximum value of 24 mA. After the oxygen reading falls below the full scale range, the mA signal will become normal.

Calibration

The electrochemical oxygen sensors generate an electrical current that is **linear** or proportional to the oxygen concentration in a sample gas. In the absence of oxygen the sensor exhibits an **absolute zero**, i.e., the sensor does not generate a current output in the absence of oxygen. Given the properties of linearity and an absolute zero, a single point calibration is possible.

The analyzer is equipped with "Zero Calibration" feature. However, as described below, zero calibration is recommended only when the application (or user) demands optimum accuracy below 5% of the most sensitive or lowest range available on the analyzer.

Span calibration is necessary to adjust the analyzer sensitivity for accurate measurements of oxygen by using a standardized (certified) oxygen or by using ambient or compressed air (20.9%).

Default Zero

This feature will eliminate any previous zero calibration adjustment and display the actual signal output of the sensor at a specified oxygen concentration. This feature allows the user to ensure that the accumulative zero offset never exceeds 10% of the lowest range limit. To perform Default Zero,

Access the MAIN MENU by pressing the MENU key.

Advance the reverse shade cursor using the ARROW keys to highlight CALIBRATION.

Press the ENTER key to select the highlighted menu option.

The following displays appear:

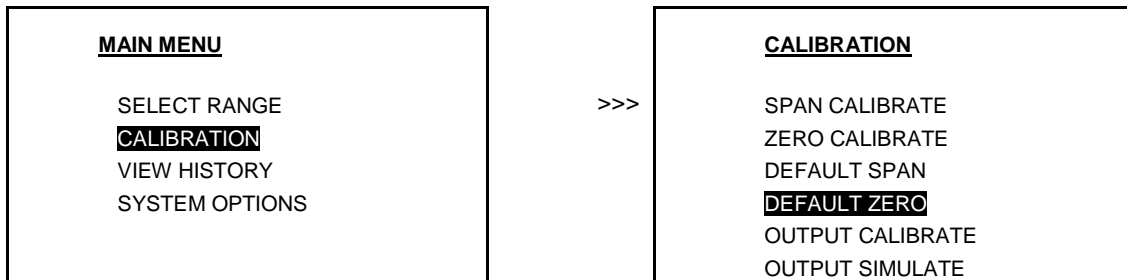

Advance the reverse shade cursor using the ARROW keys to highlight DEFAULT ZERO.

Press the ENTER key to select the highlighted menu option.

The following display appears and after 3 seconds the system returns to the SAMPLING mode:

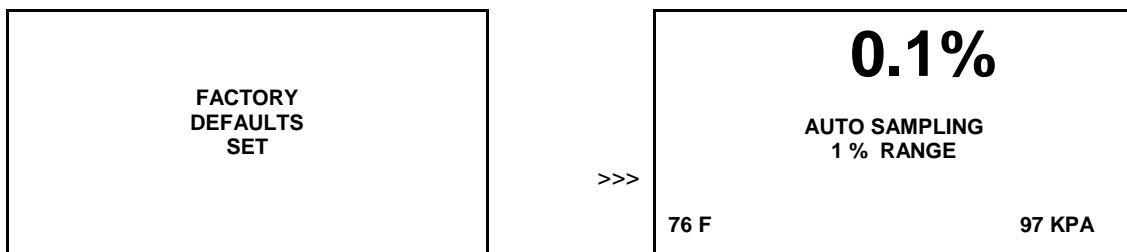

Default Span

This feature eliminates previous span calibration data and sets the analyzer sensitivity based on the average output of oxygen at a specific oxygen concentration. For example, with factory default settings, when a span gas is introduced, the micro-processor will display oxygen reading within \pm 30-50% of the span gas value, indicating that the sensor output is within specified limits. This feature allows the user to check sensor's signal output at a specified oxygen concentration without removing it from the sensor housing.

Access the MAIN MENU by pressing the MENU key.

Advance the reverse shade cursor using the ARROW keys to highlight CALIBRATION.

Press the ENTER key to select the highlighted menu option.

The following display appears:

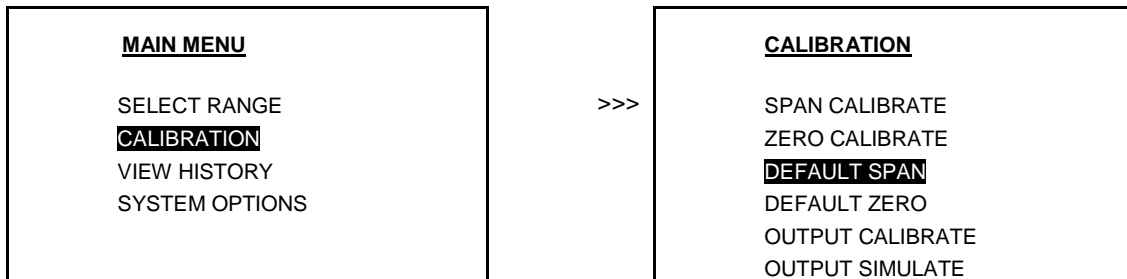

Advance the reverse shade cursor using the ARROW keys to highlight DEFAULT SPAN.

Press the ENTER key to select the highlighted menu option.

The following displays appear and the system returns to the SAMPLING mode and displays current oxygen reading.

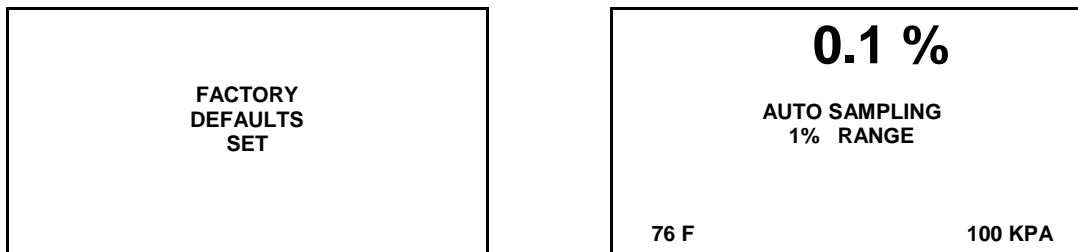

Zero Calibration

Technically, there are two types of calibration - Zero and Span. Span Calibration is required periodically for every analyzer. Zero Calibration has a more specific and limited purpose of preparing the analyzer for Span Calibration when optimum accuracy is required for measurements below 5% of the lowest or most sensitive range. In addition, Zero Calibration requires added time and expense in the form of certified zero gas or scrubber and on average 12-24 hours of wait time to perform a "true" Zero Calibration.

Typically, Zero Calibration is associated with trace PPM analyzers whose sensor and sample system are designed specifically for measurements where 5% of the lowest or most sensitive range (usually 0-10 PPM) represents 5 PPM or 0.0005%. Whereas 5% of the percentage analyzer's 0-1% (or 0-10,000 PPM) most sensitive range equates to 0.05% (or 500 PPM).

A percentage range analyzer does not have the resolution to detect oxygen levels below 10 PPM. Further, an accuracy specification of $\pm 2\%$ of the percentage range analyzer's 0-1% (or 0-10,000 PPM) full scale range equates to 200 PPM which renders lower offset value meaningless.

As a result, Analytical Industries Inc. does not recommend Zero Calibration for percentage oxygen analyzers in 99% of applications. However, the Zero Calibration capability is included in the analyzer software for the 1% and purists. Contact the factory for detailed step by step instructions.

Air Calibration

This procedure requires only a source of clean ambient air and removal of the sensor from its flow housing. Access the interior of the analyzer by removing the 2 clamps securing the door of the analyzer's fiber glass enclosure.

Caution: Do not remove the gaskets from the enclosure. Failure to do so will void the NEMA rating.

Remove the sensor from the screw-in sensor housing or push the air through the analyzer SAMPLE IN thus exposing the sensor to ambient air.

Advance the cursor on the MAIN MENU to CALIBRATE and press ENTER.

Advance the cursor to SPAN CALIBRATION and press ENTER

The following displays appear:

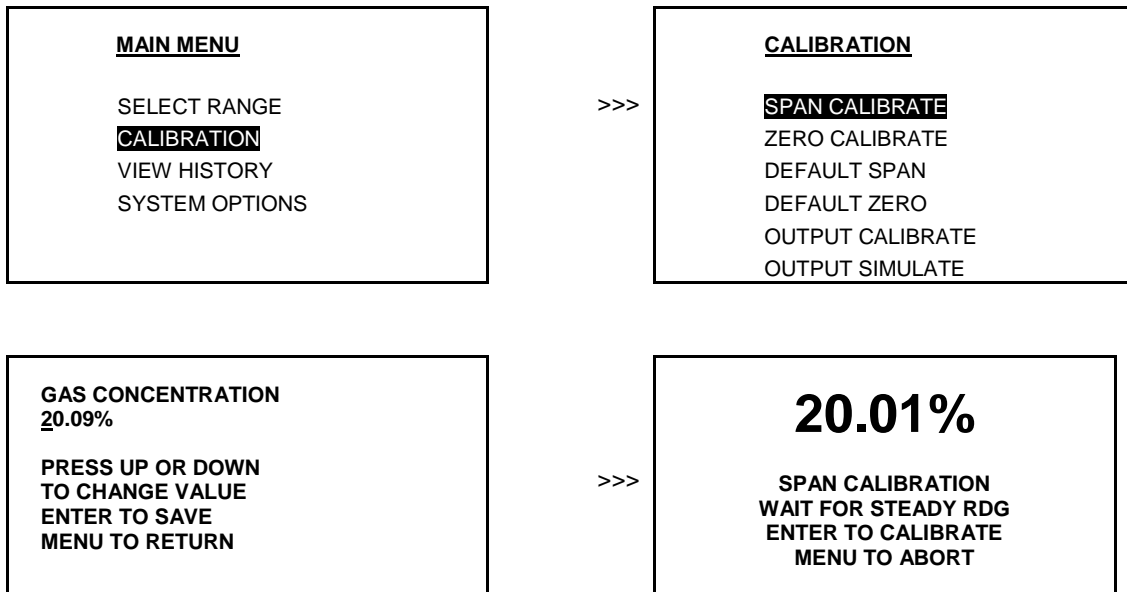

By using the UP or DOWN arrow keys, enter the appropriate digit where the cursor is blinking

Press the ENTER key to advance the underline cursor right or press the MENU key to advance the underline cursor left to reach to the desired digit of the gas value.

Repeat until complete span value has been entered.

In the example above, a span value of 20.09% has been entered.

After the span value has been entered, the analyzer will display the actual oxygen reading and prompt to press the ENTER key to accept SPAN CALIBRATION or MENU to escape.

Caution: Allow the analyzer reading to stabilize before accepting calibration.

After successful calibration, the analyzer will display a message "Passed Calibration" and return to the Sample mode.

NOTE: The analyzer is allowed to accept calibration when O2 reading is within an acceptable range. If the O2 reading is outside of this limit, by pressing ENTER to accept calibration will result in "Failed Calibration" and the analyzer will return to Sample mode without completing Span calibration. After pressing ENTER either of the following two messages will be displayed and the analyzer will return to SAMPLE mode.

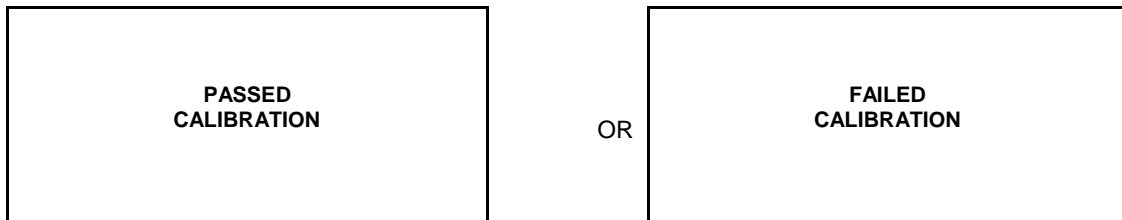

Span Gas Calibration

This procedure assumes a span gas under positive pressure. Connect the span gas or compressed air to the analyzer Span input port and set the span gas flow 1-2 SCFH by turning the Sample/Span flow to Flow Meter (purge the Span gas line before allowing the span gas to flow through sensor housing). After setting the span gas flow, switch the Sensor/Flow Meter valve to Sensor.

NOTE: To assure an accurate calibration, the temperature and pressure of the span gas must closely approximate with the sample conditions.

For calibration purposes, use of AUTO SAMPLE mode is recommended.

Access the MAIN MENU by pressing the MENU key.

Advance the reverse shade cursor using the ARROW keys to highlight AUTO SAMPLE.

Press the ENTER key to select the highlighted menu option.

The following displays appear:

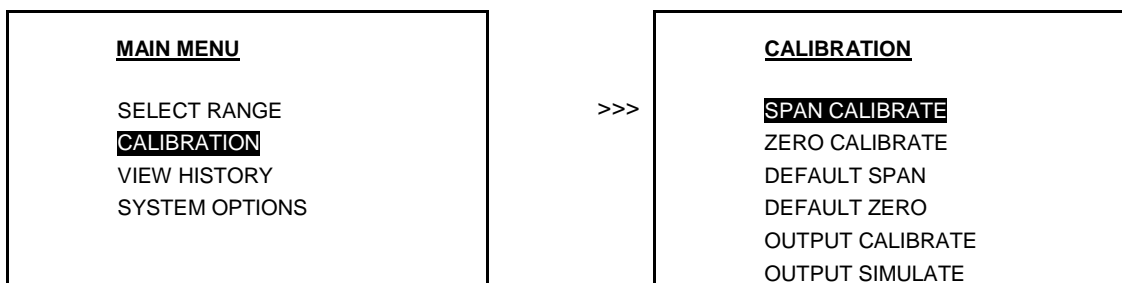

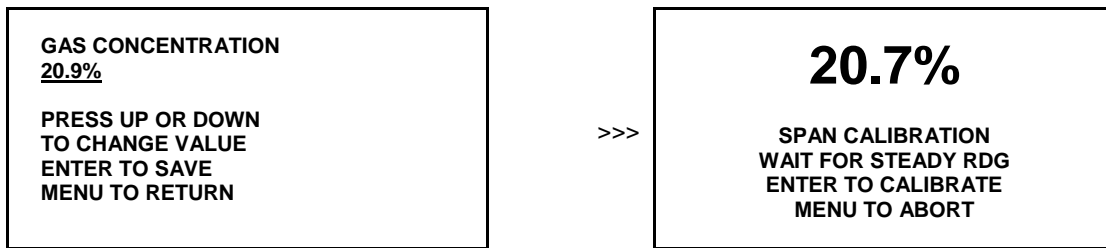

By using UP or DOWN arrow keys, enter the appropriate digit where the cursor is blinking

Press the ENTER key to advance the underline cursor right or press the MENU key to advance the underline cursor left to reach to the desired digit of the gas value.

Repeat until complete span gas value has been entered.

In the example above, a span value of 20.9% has been entered.

After the span value has been entered, the analyzer will display the actual oxygen reading and prompt to press the ENTER key to accept SPAN CALIBRATION or MENU key to escape.

Caution: Allow the analyzer reading to stabilize before accepting calibration.

After successful calibration, the analyzer will display a message "Passed Calibration" and return to the Sample mode.

NOTE: The analyzer is allowed to accept calibration when O2 reading is within an acceptable range. If O2 reading is outside of this limit, by pressing ENTER to accept calibration will result in "Failed Calibration" and analyzer will return to the Sample mode without completing Span calibration. After pressing ENTER either of the following two messages will be displayed and the analyzer will return to SAMPLE mode.

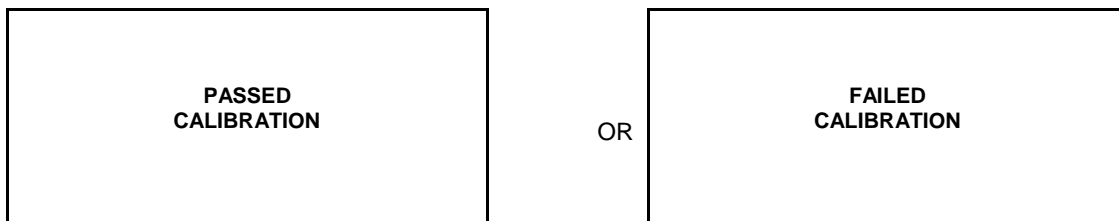

Analog Output Check- Output Simulate

This feature allows the user to simulate the electronics and the signal output. A known current is added to the analyzer electronics internally to generate an equivalent analog signal output. This feature allows the user to check all interconnections from the analyzer to the signal output recording device before installation of sensor thus preventing the user to open the sensor bag before completing satisfactory analyzer installation. To simulate signal output

Access the MAIN MENU by pressing the MENU key.

Advance the reverse shade cursor using the ARROW keys to highlight CALIBRATION and then select OUTPUT SIMULATE.

Press the ENTER key to select the highlighted menu option.

The following displays appear:

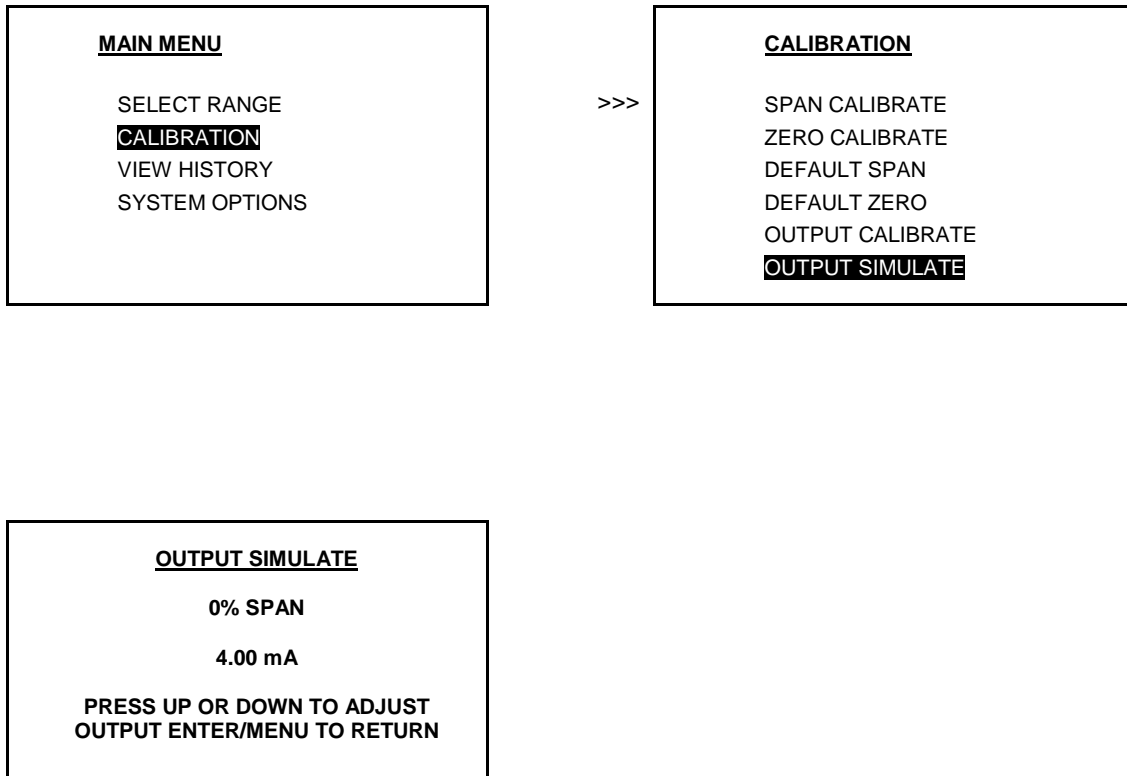

Pressing UP or DOWN key will increase or decrease the output by 5% of the full scale signal each time. Check the output on the external recording device or voltmeter/ammeter. The output on the external recording would be the % of the full scale signal selected, for example, 0% will represent 4.00 mA, 25% value will represent 8 mA and 50% span value will represent 12.0 mA of the 4-20 mA full scale. After SIMULATION is complete, press ENTER/MENU key to return to SAMPLE mode.

Note: To perform "Calibrate-Output Simulation", an external recording device must be connected between the negative terminal of the power source and negative terminal of the transmitter.

Analog Output Check- Output Calibrate

In certain cases, the full scale analog may not match with full scale display. This feature allows the user to adjust the electronics so that the full scale display matches with full scale analog signal output. To calibrate full scale signal output Access the MAIN MENU by pressing the MENU key.

Advance the reverse shade cursor using the ARROW keys to highlight CALIBRATION and then select OUTPUT SIMULATE. Press the ENTER key to select the highlighted menu option.

The following displays appear:

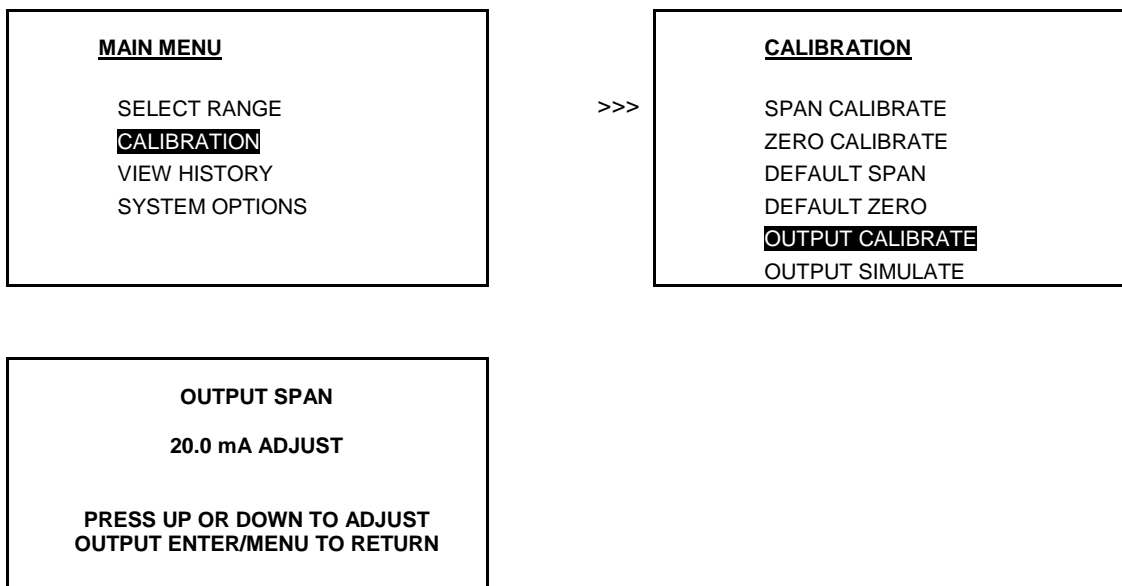

Pressing UP or DOWN key will increase or decrease the full scale output signal each time. Check the output on the external recording device or voltmeter/ammeter. Repeat this step until the out equals the full scale analog signal expected, for example 20 mA in the present case. After OUTPUT CALIBRATION is complete, press ENTER/MENU key to return to SAMPLE mode.

Sampling a Gas

GPR-2500 AIS-LD Oxygen Analyzer requires a positive pressure to flow a sample gas across the sensor to measure oxygen concentration in a sample gas. If a positive sample pressure is not available, install a high quality external sample pump to push the sample through the analyzer; see the option of using a sample pump as described above.

Procedure

Following calibration, the analyzer will return to the SAMPLE mode and ready for sampling any gas.

Select the desired sampling mode - auto or manual – as described above.

Use a suitable tubing to transport sample gas to the analyzer

Main consideration of selecting sample tubing is to eliminate any air leaks which can affect oxygen measurements.

For sample gases under positive pressure, the user must provide a means of controlling the inlet pressure as recommended.

With continuous drain feature of the analyzer, a sample gas loaded with any type of liquid can be analyzed. The liquid from sample gas will fall due to gravity and leave the sensor housing whereas the gas will separate and migrate to the sensor's sensing surface. The sensor is mounted in such a way that liquid from sample gas will not accumulate on the sensing surface of sensor.

NOTE: Assure that sample is adequately vented for optimum response and recovery – and safety.

View History

This feature allows the user to view

Maximum % O₂

Minimum % O₂

Average % O₂

Maximum ambient temperature

Number of days the sensor has been in service (at the time of installation and first calibration, the user must enter YES to confirm "new sensor") and

Number of days since the last calibration was done.

System Options

This features allows the user to

1. Set security; password protected operation
2. Define ranges; choose a range between two ranges, for example, 8% full scale instead of 5% full scale.
3. Display signal below 0.00; Negative signal, YES or NO.
4. Displays MODBUS COMM menu

Security

PASSCODE LOCK- Prevents un-authorized access to the analyzer menu options. Selecting PASSCODE LOCK will put the analyzer in Sample Mode and accessing the menus will require a valid passcode.

To enter pass code, from SYSTEM OPTIONS menu, select SECURITY, select PASSCODE LOCK and then enter four digit PASS CODE, numeral numbers only and press ENTER. Then select AUTO LOCK option and enter the number of minutes after which access to MENU options will be locked (access allowed only after entering the PASS CODE).

In the vent the PASS CODE is lost, enter the factory default PASS CODE 2855 to access the MENU and then reenter the new PASS CODE.

Choosing the option to display negative number will allow the user to see the display below 0.00 but the output will not go below 3.80 mA.

Standby

The transmitter has no special storage requirements.

The sensor should remain mounted in the sensor housing and connected to the electronics during storage periods. Before turning the sample gas OFF, ensure that sample/bypass valve (if analyzer equipped) is at the BYPASS position. This will keep the sensor isolated from ambient air and would be ready to use again when required with very short down time.

NOTE: Under isolated conditions, some oxygen will diffuse into the sample system/sensor housing and the sensor out will slowly climb up but after 2-3 hours, it will reach a Plato, generally less than 400 PPM

Store the transmitter with power OFF at a safe location and away from any direct heating source.

If storing for an extended period of time, protect the analyzer from dust, heat and moisture.

6. Maintenance

Generally, replacing oxygen sensor is the extent of the maintenance requirements of this transmitter.

Serviceability: Except for replacing oxygen sensor, there are no parts inside the transmitter for the operator to service. Only trained personnel with the authorization of their supervisor should conduct maintenance.

7. Spare Parts

Recommended spare parts for the GPR-2500 AIS Oxygen Analyzer:

Item No.	Description
GPR-11-32-LD	Oxygen Sensor, for measuring O2 in inert gases
XLT-11-24-LD	Oxygen Sensor, for measuring O2 in gases containing CO2

Other spare parts:

Item No.	Description
-----------------	--------------------

The Factory must be consulted for any other questions/maintenance

8. Troubleshooting

Symptom	Possible Cause	Recommended Action
Slow recovery	At installation, defective sensor	Replace sensor if recovery unacceptable or O ₂ reading fails to reach 10% of lowest range
	Air leak in sample system connection(s)	Leak test the entire sample system: Vary the flow rate, if the O ₂ reading changes inversely with the change in flow rate indicates an air leak - correct source of leak
	Damaged in service - prolonged exposure to air, electrolyte leak Sensor nearing end of life	Replace sensor Replace sensor
High O ₂ reading Sampling	Flow rate exceeds limits Pressurized sensor Improper sensor selection	Correct pressure and flow rate Remove restriction on vent line Replace GPR sensor with XLT sensor when CO ₂ or acid gases are present
Response time slow	Air leak, dead legs, distance of sample line, low flow rate, volume of optional filters and scrubbers	Leak test (above), reduce dead volume or increase flow rate
O ₂ reading doesn't agree to expected O ₂ values	Pressure and temperature of the sample is different than span gas Abnormality in gas	Calibrate the transmitter (calibrate at pressure and temperature of sample) Qualify the gas (use a portable analyzer as a second check)
Erratic O ₂ reading or No O ₂ reading	Change in sample pressure	Calibrate the transmitter (calibrate at pressure and temperature of sample)
	Dirty electrical contacts in upper section of sensor housing Corroded solder joints on sensor PCB from corrosive sample or electrolyte leakage	Clean contacts with alcohol (minimize exposure time of MS sensor to ambient air to extent possible) Replace sensor and return sensor to the factory for warranty determination

<p>from sensor</p> <p>Corroded spring loaded contact in upper section of sensor housing from liquid in sample or electrolyte leakage from sensor</p>	<p>Upper section of sensor housing: Clean contacts with water, wipe contacts with clean paper towel and flush system and sensor housing with dry gas</p> <p>Sensor: Replace if leaking and return it to the factory for warranty determination</p>
<p>Liquid covering sensing area</p>	<p>Wipe with lint free towel or flow dry sample or zero gas for 2-3 hours to flush out condensation</p>
<p>Improper sensor selection</p>	<p>Consult factory for recommendation.</p>
<p>Presence of interference gases</p>	<p>Replace sensor and install scrubber</p>
<p>Unauthorized maintenance</p>	<p>Consult factory.</p>
<p>Sensor nearing end of life</p>	<p>Replace sensor</p>

Erratic O₂ reading
or
Negative O₂ reading
or
No O₂ reading accompanied by electrolyte leakage

Pressurizing the sensor by flowing gas to the sensor with the vent restricted or SHUT OFF valve closed and suddenly removing the restriction draws a vacuum on the sensor

or

partially opened valves upstream of the analyzer when using a pump downstream of the analyzer to draw sample from a process at atmospheric pressure or under a slight vacuum. Placing a vacuum on the sensor in excess 10" of water column is strongly discouraged.

Zero the transmitter. If not successful replace the sensor

Avoid drawing a vacuum on the sensor, a pressurized sensor may not leak but still produce negative readings.

A premature adjustment of the ZERO OFFSET is a common problem

From MAIN MENU select DEFAULT ZERO

9. Warranty

The design and manufacture of GPR Series oxygen transmitters/analyzers, monitors and oxygen sensors are performed under a certified Quality Assurance System that conforms to established standards and incorporates state of the art materials and components for superior performance and minimal cost of ownership. Prior to shipment every analyzer is thoroughly tested by the manufacturer and documented in the form of a Quality Control Certification that is included in the Owner's Manual accompanying every analyzer. When operated and maintained in accordance with the Owner's Manual, the units will provide many years of reliable service.

Coverage

Under normal operating conditions, the monitor, analyzers and sensor are warranted to be free of defects in materials and workmanship for the period specified in accordance with the most recent published specifications, said period begins with the date of shipment by the manufacturer. The manufacturer information and serial number of this analyzer are located on the rear of the analyzer. Advanced Instruments Inc. reserves the right in its sole discretion to invalidate this warranty if the serial number does not appear on the analyzer.

If your Advanced Instruments Inc. monitor, analyzer and/or oxygen sensor is determined to be defective with respect to material and/or workmanship, we will repair it or, at our option, replace it at no charge to you. If we choose to repair your purchase, we may use new or reconditioned replacement parts. If we choose to replace your Advanced Instruments Inc. analyzer, we may replace it with a new or reconditioned one of the same or upgraded design. This warranty applies to all monitors, analyzers and sensors purchased worldwide. It is the only one we will give and it sets forth all our responsibilities. There are no other express warranties. This warranty is limited to the first customer who submits a claim for a given serial number and/or the above warranty period. Under no circumstances will the warranty extend to more than one customer or beyond the warranty period.

Limitations

Advanced Instruments Inc. will not pay for: loss of time; inconvenience; loss of use of your Advanced Instruments Inc. analyzer or property damage caused by your Advanced Instruments Inc. analyzer or its failure to work; any special, incidental or consequential damages; or any damage resulting from alterations, misuse or abuse; lack of proper maintenance; unauthorized repair or modification of the analyzer; affixing of any attachment not provided with the analyzer or other failure to follow the Owner's Manual. Some states and provinces do not allow limitations on how an implied warranty lasts or the exclusion of incidental or consequential damages, these exclusions may not apply.

Exclusions

This warranty does not cover installation; defects resulting from accidents; damage while in transit to our service location; damage resulting from alterations, misuse or abuse; lack of proper maintenance; unauthorized repair or modification of the analyzer; affixing of any label or attachment not provided with the analyzer; fire, flood, or acts of God; or other failure to follow the Owner's Manual.

Service

Call Advanced Instruments Inc. at 909-392-6900 (or e-mail info@aii1.com) between 7:30 AM and 5:00 PM Pacific Time Monday thru Thursday or 8:00 AM to 12:00 pm on Friday. Trained technicians will assist you in diagnosing the problem and arrange to supply you with the required parts. You may obtain warranty service by returning you analyzer, postage prepaid to:

Advanced Instruments Inc.
2855 Metropolitan Place
Pomona, Ca 91767 USA
Tel: +1 909 392 6900

Be sure to pack the analyzer securely. Include your name, address, telephone number, and a description of the operating problem. After repairing or, at our option, replacing your Advanced Instruments Inc. analyzer, we will ship it to you at no cost for parts and labor.

10. MSDS – Material Safety Data Sheet

Product Identification

Product Name	Oxygen Sensor Series - PSR, GPR, AII, XLT
Synonyms	Electrochemical Sensor, Galvanic Fuel Cell
Manufacturer	Advanced Instruments Inc., 2855 Metropolitan Place, Pomona, CA 91767 USA
Emergency Phone Number	909-392-6900
Preparation / Revision Date	January 1, 1995
Notes	Oxygen sensors are sealed, contain protective coverings and in normal conditions do not present a health hazard. Information applies to electrolyte unless otherwise noted.

Specific Generic Ingredients

Carcinogens at levels > 0.1%	None
Others at levels > 1.0%	Potassium Hydroxide or Acetic Acid, Lead
CAS Number	Potassium Hydroxide = KOH 1310-58-3 or Acetic Acid = 64-19-7, Lead = Pb 7439-92-1
Chemical (Synonym) and Family	Potassium Hydroxide (KOH) – Base or Acetic Acid (CH ₃ CO ₂ H) – Acid, Lead (Pb) – Metal

General Requirements

Use	Potassium Hydroxide or Acetic Acid - electrolyte, Lead - anode
Handling	Rubber or latex gloves, safety glasses
Storage	Indefinitely

Physical Properties

Boiling Point Range	KOH = 100 to 115° C or Acetic Acid = 100 to 117° C
Melting Point Range	KOH -10 to 0° C or Acetic Acid – NA, Lead 327° C
Freezing Point	KOH = -40 to -10° C or Acetic Acid = -40 to -10° C
Molecular Weight	KOH = 56 or Acetic Acid – NA, Lead = 207
Specific Gravity	KOH = 1.09 @ 20° C, Acetic Acid = 1.05 @ 20° C
Vapor Pressure	KOH = NA or Acetic Acid = 11.4 @ 20° C
Vapor Density	KOH – NA or Acetic Acid = 2.07
pH	KOH > 14 or Acetic Acid = 2-3
Solubility in H ₂ O	Complete
% Volatiles by Volume	None
Evaporation Rate	Similar to water

Appearance and Odor

Aqueous solutions: KOH = Colorless, odorless or Acetic Acid = Colorless, vinegar-like odor

Fire and Explosion Data

Flash and Fire Points

Not applicable

Flammable Limits

Not flammable

Extinguishing Method

Not applicable

Special Fire Fighting Procedures

Not applicable

Unusual Fire and Explosion Hazards

Not applicable

Reactivity Data

Stability

Stable

Conditions Contributing to Instability

None

Incompatibility

KOH = Avoid contact with strong acids or Acetic Acid = Avoid contact with strong bases

Hazardous Decomposition Products

KOH = None or Acetic Acid = Emits toxic fumes when heated

Conditions to Avoid

KOH = None or Acetic Acid = Heat

Spill or Leak

Steps if material is released

Sensor is packaged in a sealed plastic bag, check the sensor inside for electrolyte leakage. If the sensor leaks inside the plastic bag or inside an analyzer sensor housing do not remove it without rubber or latex gloves and safety glasses and a source of water. Flush or wipe all surfaces repeatedly with water or wet paper towel (fresh each time).

Disposal

In accordance with federal, state and local regulations.

Health Hazard Information

Primary Route(s) of Entry

Ingestion, eye and skin contact

Exposure Limits

Potassium Hydroxide - ACGIH TLV 2 mg/cubic meter or Acetic Acid - ACGIH TLV / OSHA PEL 10 % (TWA), Lead - OSHA PEL .05 mg/cubic meter

Ingestion

Electrolyte could be harmful or fatal if swallowed. KOH = Oral LD50 (RAT) = 2433 mg/kg or Acetic Acid = Oral LD50 (RAT) = 6620 mg/kg

Eye

Electrolyte is corrosive and eye contact could result in permanent loss of vision.

Skin

Electrolyte is corrosive and skin contact could result in a chemical burn.

Inhalation

Liquid inhalation is unlikely.

Symptoms

Eye contact - burning sensation. Skin contact - soapy slick feeling.

Medical Conditions

None

Aggravated

Carcinogenic Reference
Data

KOH and Acetic Acid = NTP Annual Report on Carcinogens - not listed; LARC
Monographs - not listed; OSHA - not listed

Other

Lead is listed as a chemical known to the State of California to cause birth
defects or other reproductive harm.

Special Protection Information

Ventilation Requirements

None

Eye

Safety glasses

Hand

Rubber or latex gloves

Respirator Type

Not applicable

Other Special Protection

None

Special Precautions

Precautions

Do not remove the sensor's protective Teflon and PCB coverings. Do not
probe the sensor with sharp objects. Wash hands thoroughly after handling.
Avoid contact with eyes, skin and clothing.

Empty sensor body may contain hazardous residue.

Transportation

Not applicable

Appendix A

Electrical connections require an approved explosion proof sealing fitting and packing around wires and cables (for incoming power for the analyzer electronics and 4-20mA signal output) coming into and out of the explosion proof enclosure that houses the power supply/signal output PCB.

Full compliance with hazardous area electrical code requires the user to supply glands, fittings and/or conduit commensurate with the level of protection or classification desired. To maintain the ATEX certification of this unit, the user must install ATEX approved components according to ATEX directives. To meet US and Canada requirements for use in Class I, Division 1, Groups C, D hazardous areas, the user must install the appropriate components according to the NEC standards (US) or CEC standards (Canada).

Note: The following instruction is supplied from information and data supplied by a reputable enclosure manufacturer which we believe is reliable and is given in good faith. Since the methods of application and conditions under which our products are put to use are beyond our control, we are not able to guarantee the application and/or use of same. The user assumes all risks and liability in connection with the application and use of our products.



Directions for use Of Explosion Proof Packing Fiber (non-asbestos)

For use as packing at the hub of sealing fittings, tamp packing fiber between and around conductors where they enter fitting to prevent leakage of the liquid cement. Leave enough space in the fitting for length equivalent to the inside diameter of the conduit but, not less than 5/8".



Caution: Avoid getting in eyes or breathing dust
Use barrier cream, gloves and long sleeve shirts if dust or fiber is irritating.

Prolonged contact may cause lung, eye or skin irritation. Directions for use



Explosion Proof Sealing Cement: Tamp packing fiber between and around conductors where they enter the sealing fitting to prevent leakage of liquid cement. Make sure conductors are not in contact with each other or with the wall of fitting. Leave space in the fitting for a sealing length equivalent to the thread size of the conduit seal but not less than 5/8"

Fill the marked shipping container with clean cold water to the "water line" [35 ml to be precise].

Caution: Do not exceed the required amount of water.



Gradually pour cement from the plastic bag into the water and stir thoroughly for proper mixture. Fill fitting completely within five (5) minutes after mixing, then tamp with blunt stick to expel any air bubbles. Close up any opening in the fitting to insure integrity of the seal. Fittings requiring more than 10 oz. of cement must be filled from a single mixture of cement and water. **DO NOT POUR IN STAGES.** Allow cement at least 72 hours to cure. Water-mix sealing compound should not be poured or installed at temperature below 40F (4C). Maintain temperature at or above 40F for at least 72 hours after pouring. CSA certified when used with any CSA certified sealing fitting. Adaco No. 1 sealing cement must be used as a part of any Adalet UL listed fitting.

Caution: At least five threads must engage on all fill plugs.

Caution: Prolonged breathing or ingestion may cause internal obstruction, seek medical care.

Do not get into eyes or on skin – if cement touches eyes or skin, flush with water for 15 minutes.

Large amounts on skin when hardening may cause skin burn.

Use adequate ventilation.

To reorder sealing cement kit, specify P/N ENCL-1071-KIT

