



## Technical Specifications \*

Accuracy:	2% of FS range under constant conditions
Analysis:	0-20, 0-50, 0-100 PPM FS ranges; Auto-ranging or manually lock on single range
Application:	Trace H <sub>2</sub> S in flowing gas streams
Approvals:	Certified for use in hazardous areas - see lower right UL: United States: UL 1203, UL 913, UL 508 Canada: CAN/CSA C22.2 No. 30-M1986, CAN/CSA C22.2 No. 157-92, CAN/CSA C22.2 No. 14-10 ATEX: Directive 94/9/EC
Area Classification:	Certified for use in hazardous areas - see lower right
Alarms:	Two user configurable alarms: magnetic coil relays rated 3A at 100 VAC, programmable alarm delays, alarm bypass for calibration and system fail alarm
Calibration:	Span gas 50-80 PPM H <sub>2</sub> S balance air/nitrogen
Compensation:	Barometric pressure (ATEX only)
Connections:	<b>1/4" Sample/Span; 3/8" Vent line.</b>
Controls:	Water resistant keypad; menu driven range selection, calibration and system functions
Display:	<b>Graphical LCD 2.75" x 1.375"; resolution 0.1 PPM;</b> displays real time ambient temperature and pressure
Enclosure:	NEMA Type 3R for rain in outdoor applications (UL) NEMA 4X (ATEX)
Flow:	Maintain constant flow at 1 SCFH, maintain Sample to Air ratio of 1:1
Linearity:	±2% of full scale
Pressure:	Inlet - regulate to 5-30 psig to deliver constant 1 SCFH flow; vent - atmospheric
Power:	12-28 VDC (UL or ATEX Certified) 110-220 VAC (ATEX Certified) Transmitter, 12-24 VDC PUMP
Response Time:	90% of final reading in 60 seconds
Sample System:	Coalescing filter, flow meters, sample/span valve; Note: Sensor requires 2-3 hours exposure to air to recover from exposure to condensed moisture.
Sensitivity:	< 0.5% of FS range
Sensor Model:	OSV-72-7HH (standard ranges)
Sensor Life:	24 months at 25°C and 1 atm
Signal Output:	4-20mA or 1-5 VDC
Operating Range:	-10 °C to 45°C
Warranty:	12 months analyzer; 12 months sensor
Wetted Parts:	Stainless steel

**UL or ATEX Certified for Hazardous Areas**



## **GPR-7500 AIS PPM H<sub>2</sub>S Analyzer**

**Full Featured H<sub>2</sub>S Analyzer**

**Exia**



**UL Certified**  
File E343386

**Class I, Division 1, Groups C and D**  
T<sub>4</sub> T<sub>amb</sub> -20°C to +50°C

**ATEX Certified - Directive 94/9/EC**  
Examination Cert: INERIS 08ATEX0036



**II 2 G**  
Ex d [ib] ib IIB T<sub>4</sub> Gb  
T<sub>amb</sub> -20°C to +50°C



## Optional Equipment

- Additional sample conditioning systems - Contact factory
- OSV-72-7H sensor for 0-500 PPM, 0-1000, 0-2000 PPM FS ranges

\* Specifications subject to change without notice

**ISO 9001:2008 Certified**  
**INTERTEK Certificate No. 485**



*GPR-7500 AIS*  
*PPM H<sub>2</sub>S Transmitter*



Owner's Manual

Revised May 13, 2015

---



---

# Table of Contents

<b>Introduction</b>		<b>1</b>
<b>Quality Control Certification</b>		<b>2</b>
<b>Safety</b>		<b>3</b>
<b>Features &amp; Specifications</b>		<b>4</b>
<b>Operation</b>		<b>5</b>
<b>Maintenance</b>		<b>6</b>
<b>Spare Parts</b>		<b>7</b>
<b>Troubleshooting</b>		<b>8</b>
<b>Warranty</b>		<b>9</b>
<b>Material Safety Data Sheets</b>		<b>10</b>
<b>Drawings</b>		<b>A/R</b>
<b>Explosion Proofing Electrical Connections</b>	<b>Appendix</b>	<b>A</b>
<b>Correlating readings – LCD display to 4-20mA signal output</b>	<b>Appendix</b>	<b>B</b>
<b>H2S Scrubber, Sample System, Media MSDS</b>	<b>Appendix</b>	<b>F</b>
<b>Maintenance H2S Scrubber &amp; Coalescing Filter</b>	<b>Appendix</b>	<b>G</b>

The appendices referenced above are an integral part of the documentation, installation and maintenance of this transmitter to comply with all applicable directives. It is important that users review these documents before proceeding.

# 1. Introduction

Your new Hydrogen Sulfide Transmitter incorporates an advanced electrochemical sensor specific to hydrogen sulfide along with state-of-the-art digital electronics designed to give you years of reliable precise measurements of hydrogen sulfide in a variety of industrial applications. More importantly, it has been constructed as explosion proof/intrinsically safe in accordance with Safety Standard EN 60079-0:2009, EN 60079-1:2007 and EN 60079-11:2012, UL 913 Seventh Edition and CSA C22.2 No. 157-92 Third Edition, for use in Class I, Div 1, Groups C and D hazardous locations. It also conforms to ATEX Directives 94/9/EC for use in hazardous areas in zone 1 Group C and D

Please refer to Appendix A for information on making electrical connections that maintain the desired level of protection.

To obtain maximum performance from your new hydrogen sulfide transmitter, please read and follow the guidelines provided in this Owner's Manual.

Every effort has been made to select the most reliable state of the art materials and components, to design the transmitter for superior performance and minimal cost of ownership. This transmitter was tested thoroughly by the manufacturer prior to shipment for best performance.

However, modern electronic devices do require service from time to time. The warranty included herein plus a staff of trained professional technicians to quickly service your transmitter is your assurance that we stand behind every transmitter sold.

The serial number of this transmitter may be found on the inside the transmitter enclosure. You should note the serial number in the space provided and retains this Owner's Manual as a permanent record of your purchase, for future reference and for warranty considerations.

Serial Number: \_\_\_\_\_

Advanced Instruments Inc. appreciates your business and pledges to make every effort to maintain the highest possible quality standards with respect to product design, manufacturing and service.

## 2. General Safety & Installation

This section summarizes the essential precautions applicable to the GPR-7500 AIS Hydrogen Sulfide Transmitter. Additional precautions specific to individual transmitter are contained in the following sections of this manual. To operate the transmitter safely and obtain maximum performance follow the basic guidelines outlined in this Owner's Manual.



**Caution:** This symbol is used throughout the Owner's Manual to Caution and alert the user to recommended safety and/or operating guidelines.



**Warning:** This symbol is used throughout the Owner's Manual to Warn and alert the user of the presence of electrostatic discharge.



**Danger:** This symbol is used throughout the Owner's Manual to identify sources of immediate Danger such as the presence of hazardous voltages.

**Read Instructions:** Before operating the transmitter read the instructions.

**Retain Instructions:** The safety precautions and operating instructions found in the Owner's Manual should be retained for future reference.

**Heed Warnings:** Follow all warnings on the transmitter, accessories (if any) and in this Owner's Manual.

**Follow Instructions:** Observe all precautions and operating instructions. Failure to do so may result in personal injury or damage to the transmitter.

Transmitter Label ULC, (ATEX label not shown for clarity)

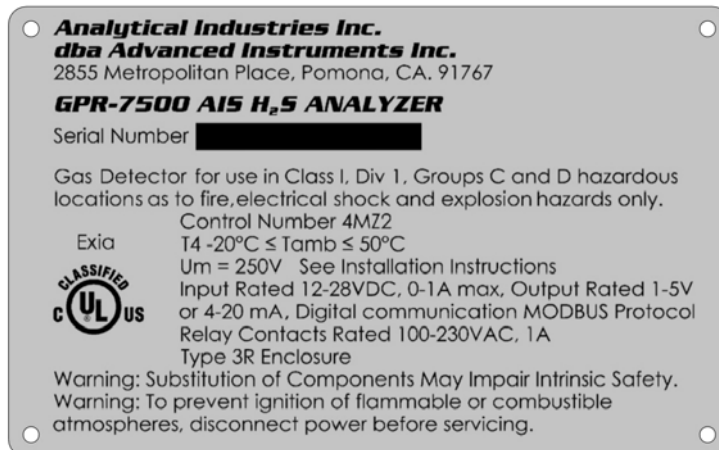

**WARNING – Potential Explosion Hazard:** The devices are not intended for use in atmospheres or with sample gas streams containing oxygen concentration greater than 21 percent by volume (ambient air) and are only intended for use in gases or gas mixtures classified as Class I, Div 1, Groups C and D hazardous locations, when used in the United States or Canada.

## 2. Quality Control Certification

See Packing slip.

## 3. Maintenance

**Serviceability:** Except for replacing the hydrogen sulfide sensor, there are no parts inside the transmitter for the operator to service.

**WARNING- Substitution of Components May Impair Intrinsic Safety**

Only trained personnel with the authorization of their supervisor should conduct maintenance.

**H<sub>2</sub>S Sensor:** DO NOT open the sensor. The sensor contains a corrosive liquid electrolyte that could be harmful if touched or ingested, refer to the Material Safety Data Sheet contained in the Owner's Manual appendix. Avoid contact with any liquid or crystal type powder in or around the sensor or sensor housing, as either could be a form of electrolyte. Leaking sensors should be disposed of in accordance with local regulations.

**Troubleshooting:** Consult the guidelines in Section 8 for advice on the common operating errors before concluding that your transmitter is faulty. Do not attempt to service the transmitter beyond those means described in this Owner's Manual.

Do not attempt to make repairs by yourself as this will void the warranty as per Section 10 and may result in electrical shock, injury or damage. All other servicing should be referred to qualified service personnel.

**Cleaning:** The transmitter should be cleaned only as recommended by the manufacturer. Wipe off dust and dirt from the outside of the unit with a soft damp cloth then dry immediately. Do not use solvents or chemicals.

**Non-use Period:** If the transmitter is equipped with a range switch advance the switch to the OFF position and disconnect the power when the transmitter is left unused for a long period of time.

## Installation

This transmitter has been constructed in compliance with

EN 60079-0 : 2009

EN 60079-1 : 2007

EN 60079-11 : 2012

ATEX Directive 94/9/EC

For USA and Canada

UL 913, 7<sup>th</sup> Edition

CSA C22.2 No. 157-92

It must be installed in accordance with

EN 60079-14

For USA - NEC and Canada – CEC Standards

**WARNING - Potential Explosion Hazard – See Warning in Section 4 – Features and Specifications**

**Sampling Stream:** Ensure the gas stream composition of the application is consistent with the specifications and if in doubt, review the application and consult the factory before initiating the installation. **Note:** In natural gas applications such as extraction and transmission, a low voltage current is applied to the pipeline itself to inhibit corrosion of the pipeline. As a result, electronic devices connected to the pipeline can be affected unless they are adequately grounded.

**Contaminant Gases/Liquids in Sample Stream:** A sample flow indicator with integral metering valve is required upstream of the transmitter to remove any interfering gases such as oxides of sulfur and nitrogen that can interfere with measurement. Sample must be free from any condensable liquid. With gas streams containing condensable liquids, a coalescing filter must be installed upstream of the sensor. Consult the factory for recommendations concerning the proper selection and installation of sample conditioning requirements.

**Expected Sensor Life:** With reference to the publish specification located in Section 4 of this manual, the expected life of all H<sub>2</sub>S sensors is predicated on the rate of loss of electrolyte from the sensor at temperature of 77°F/25°C and pressure of 1 atmosphere in "normal" applications. Deviations from standard conditions will affect the life of the sensor (temperature higher than 77°C and pressure less than atmospheric would cause a reduction in the sensor life).

**Accuracy and Calibration:** Refer to section 5 Operation.

**Material and Gases:** Assemble the necessary zero, sample and span gases and optional components such as valves, coalescing or particulate filters, and pumps as dictated by the application. Stainless steel tubing is essential for maintaining the integrity of the gas stream for low PPM H<sub>2</sub>S level analysis.



**Operating Temperature:** The sample must be sufficiently cooled before it enters the transmitter and any optional components. A coiled 10 foot length of 1/4" stainless steel tubing is sufficient for cooling sample gases as high as 1,800 °F to ambient. The recommended operating temperature is below 35 °C. However, the transmitter may be operated at temperature up to 45 °C on an intermittent basis but the user is expected to accept a reduction in expected sensor life –as a rule of thumb, for every degree °C increase in temperature (above 25 °C), the sensor life is reduced by approximately 2.5%.

**Warning – Sample Stream entering unit must never exceed 50 °C**

**Heat:** Install the transmitter away from direct sun and from any source of heat. Situate and store the transmitter away from direct sources of heat.

**Liquid and Solid Object Entry:** The transmitter should not be immersed in any liquid. Care should be taken so that liquids are not spilled into and objects do not fall on or inside of the transmitter.

**Handling:** Do not use force when using the switches, knobs or other mechanical components. Before moving your transmitter be sure to disconnect the wiring/power cord and any cables connected to the output terminals of the transmitter.

## Sample Pressure and Flow

All electrochemical sensors respond to partial pressure changes in the gas of interest. The sensors are equally capable of analyzing the H<sub>2</sub>S content of a flowing sample gas stream or monitoring the H<sub>2</sub>S concentration in ambient air (such as a confined space in a control room or an open area around a landfill or bio-pond). The following is applicable to transmitters equipped with electrochemical sensors.

Transmitters designed for in-situ ambient or area monitoring has no real sample inlet and vent. The sensor is exposed directly to the sample gas and it is intended to operate at atmospheric pressure. The transmitter has a built-in pressure sensor and the sensor output is automatically compensated for any atmospheric pressure changes. The transmitters function equally well with sample gas flowing across the sensor provided the sample does not produce any positive pressure or create a partial vacuum on the sensor. For positive sample pressure applications, suitable means must be employed to control the sample flow without subjecting the sensor to high sample pressure. For applications where the sample is less than atmospheric pressure, consult factory before initiating installation.

**Inlet Pressure:** For the transmitters designed to measure H<sub>2</sub>S in a flowing gas stream, the inlet sample pressure must be regulated between 5-30 psig. Although the rating of the SS tubing and tube fittings/valves itself is considerably higher (more than 100 psig), a sample pressure of 5-30 psig is recommended for ease of control of sample flow.

The transmitter equipped with a sample system has designated SAMPLE and VENT ports. Connect SAMPLE gas to SAMPLE and the vent to the VENT ports only.



**Caution:** If the transmitter is equipped with an optional coalescing filter, sample inlet pressure must not exceed 30 psig.

**Outlet Pressure:** In applications where sample pressure is positive, the sample must be vented to an exhaust pipe at a pressure less than the inlet pressure so that the sample gas can flow through the sensor housing. Ideally, the sample must be vented to atmospheric pressure.

**Note:** The sensor may be used at a slight positive pressure (e.g., when sample is vented to a common exhaust where the pressure might be higher than 1 atmosphere). However, the pressure at the sensor must be maintained at all times including during the span calibration. This may be accomplished by using a back-pressure regulator, (set at no greater than 0.2 PSIG) at vent line of the transmitter. **Caution:** A sudden change in pressure at the sensor may result in the sensor electrolyte leakage and permanent damage to the sensor.

**Application, Positive-Pressure** Transmitter is equipped with integral flow control valve upstream of the sensor. If necessary, a pressure regulator upstream of the flow control valve should be used to regulate the inlet pressure between 5-30 psig.

Flow rates of 1 SCFH is recommended and must be maintained close to this value as the sample is blended with air (see below) continuously. A significant variation of the flow rate may affect the sensor signal output to a level that it wouldn't calibrate.



**Air Flow:** The air flow (from the integral pump mounted in a separate Ex enclosure, see page 17) is set at 1 SCFH and is constantly blended with the sample gas. Sample flow rate of 1 SCFH is recommended and must be maintained during analysis. The air to sample flow ratio of 1:1 must be maintained at all times (during calibration as well as during analysis).

**Note:** For ranges above 100 PPM, the Sample to Air ratio is 1:5 (for example, set sample flow at 0.4 SCFH and air flow at 2 SCFH to get 1:5 ratio).



**Caution:** Failure in maintaining the sample to air flow ratio will cause an error in the H2S reading (as a percent of the reading) equivalent to the new sample to air flow ratio (see Section 5 page 25-26 for details).

**Moisture & Particulates:** Installation of a suitable coalescing or particulate filter is required to remove condensation, moisture and/or particulates from the sample gas to prevent erroneous analysis readings and damage to the sensor or other optional components. Moisture and/or particulates do not necessarily damage the sensor. However, collection of moisture/particulate on the sensing surface can block or inhibit the diffusion of sample gas into the sensor resulting in a reduction of sensor signal output and the appearance of a sensor failure. Consult factory for recommendations concerning the proper selection and installation of optional components.

Moisture and/or particulates deposited on the sensing surface of the sensor generally can be removed by removing the sensor from the housing and either blowing gas on the sensing surface or gently wiping the sensing surface with a dampened cloth.

**Mounting of the Transmitter:** The transmitter is approved for indoor as well as outdoor use. However, avoid mounting in an area where direct sun might heat up the transmitter beyond the recommended operating temperature range. If possible, install a small hood over the transmitter for rain water drain and to prevent over-heating of transmitter.

**Gas Connections:** The Inlet and outlet vent gas lines require 1/4" and 3/8" stainless steel compression type tube fittings. The sample inlet tubing must be metallic, preferably SS. The sample vent line may be of SS or hard plastic tubing with low gas permeability.

**Power Requirement:** Supply power to the transmitter only as rated by the specification or markings on the transmitter enclosure. The GPR-7500AIS is powered by 12-28 VDC. A separate 12 or 24 VDC power is required for air pump housed in a separate enclosure. The wiring that connects the transmitter and pump to the power source should be installed in accordance with recognized electrical standards. Ensure that the transmitter case is properly grounded and meets the requirements for area classification where the transmitter is installed. Never yank wiring to remove it from a terminal connection.

**Power Consumption:** The maximum power the transmitter consumes is no more than 7 Watts.

## 4. Features & Specifications



### Technical Specifications \*

Accuracy:	< 2% of FS range under constant conditions
Analysis:	0-20, 0-50, 0-100 PPM FS ranges; Auto-ranging or manually lock on single range
Application:	Trace H <sub>2</sub> S in flowing gas streams
Approvals:	Certified for use in hazardous areas - see lower right UL: United States: UL 1203, UL 913, UL 508 Canada: CAN/CSA C22.2 No. 30-M1986, CAN/CSA C22.2 No. 157-92, CAN/CSA C22.2 No. 14-10 ATEX: Directive 94/9/EC
Area Classification:	Certified for use in hazardous areas - see lower right
Alarms:	Two user configurable alarms: magnetic coil relays rated 3A at 100 VAC, programmable alarm delays, alarm bypass for calibration and system fail alarm
Calibration:	Span gas 50-80 PPM H <sub>2</sub> S balance air/nitrogen
Compensation:	Barometric pressure, temperature not required
Connections:	1/4" Sample/Span; 3/8" Vent line.
Controls:	Water resistant keypad; menu driven range selection, calibration and system functions
Display:	Graphical LCD 2.75" x 1.375"; resolution 0.1 PPM; displays real time ambient temperature and pressure
Enclosure:	NEMA Type 3R for rain in outdoor applications
Flow:	Maintain constant flow at 1 SCFH, maintain Sample to Air ratio of 1:1
Linearity:	±2% of full scale
Pressure:	Inlet - regulate to 5-30 psig to deliver constant 1 SCFH flow; vent - atmospheric
Power:	12-28 VDC (UL or ATEX Certified) 110-220 VAC (ATEX Certified) Transmitter, 12 VDC PUMP
Response Time:	90% of final reading in 90 seconds
Sample System:	Coalescing filter, flow meters, sample/span valve; Note: Sensor requires 2-3 hours exposure to air to recover from exposure to moisture.
Sensitivity:	< 0.5% of FS range
Sensor Model:	OSV-72-7HH-LM (standard ranges)
Sensor Life:	24 months at 25°C and 1 atm
Signal Output:	4-20mA; optional Modbus RTU communication
Operating Range:	-10 °C to 45°C
Warranty:	12 months analyzer; 12 months sensor
Wetted Parts:	Stainless steel

### Optional Equipment

Sample conditioning systems (see back page) - Contact factory  
 OSV-72-7H-LM sensor for 0-500 PPM, 0-1000, 0-2000 PPM FS ranges

\* Specifications subject to change without notice

**UL or ATEX Certified for Hazardous Areas**



**GPR-7500 AIS  
 PPM H<sub>2</sub>S Analyzer**  
 Full Featured H<sub>2</sub>S Analyzer

Exia  
 CLASSIFIED  
 UL US  
**UL Certified**  
 File E343386  
**Class I, Division 1, Groups C and D**  
 T<sub>4</sub> T<sub>amb</sub> -20°C to +50°C

**ATEX Certified - Directive 94/9/EC**  
 Examination Cert: INERIS 08ATEX0036  
 II 2 G  
 Ex d ib IIB T4 Gb  
 T<sub>amb</sub> -20°C to +50°C  
 CE 0080

**ISO 9001:2008 Certified**  
 INTERTEK Certificate No. 485  
 INTERTEK  
 ISO 9001:2008

**\*WARNING** - Potential Explosion Hazard : The devices are not intended for use in atmospheres containing more than 21% oxygen (ambient air) and are only intended for use with or in gases or gas mixtures classified as Class I, Div 1 Groups C and D hazardous location gases when used in the United States or Canada.

**\*\*NOTE 1:** Optional Sampling system shown is not part of UL/cUL Classification.

## 5. Operation

### Principle of Operation

The GPR-7500AIS H<sub>2</sub>S Transmitter incorporates a variety of advanced electrochemical sensors. These sensors are very specific to H<sub>2</sub>S and generate an electrical signal proportional to the amount of H<sub>2</sub>S present in a gas stream. The selection of a particular type of sensor depends on the maximum concentration of H<sub>2</sub>S contents in the sample stream. Consult the factory for recommendation.

The transmitter is configured in two sections. The signal processing electronics and sensor are housed in a general purpose NEMA 4X rated enclosure. The terminals of power input, signal output and the intrinsic safety barriers are mounted on a PCB housed in an explosion proof enclosure.

The two sets of electronics are interconnected using an explosion proof Y-fitting, explosion proof packing fiber and sealing cement. Once connected, the intrinsic safety barriers limit the amount of power that flows to and from the signal processing electronics effectively preventing an explosive condition.

**Air pump is housed in a separate explosion proof enclosure and requires 12 or 24 VDC power through a separate conduit. The pump supplies air at a constant flow that is blended with sample stream continuously.**

The transmitter is available with two sets of ranges.

**0-20 PPM, 0-50 PPM and 0-100 PPM**

**Sample to air ratio 1:1**

**or**

**0-500 PPM, 0-1000 PPM and 0-2000 PPM**

**Sample to air ratio 1:5**

Check QC accompanying the transmitter to confirm the ranges ordered.

The GPR-7500AIS meets the cUL and ATEX intrinsic safety standards required for use in Class I, Division 1, Group C, D hazardous areas.

## Advanced Electrochemical Sensor Technology

All electrochemical sensors driven by a bias potential (three electrode configuration) function on the same principle and are specific to a certain gas. They measure the partial pressure of the target gas from low PPM to up to 1% levels in air, inert gases and gaseous hydrocarbons.

The target gas, in this case, Hydrogen Sulfide, diffuses into the sensor through a diffusion limiting membrane, reacts electrochemically at the sensing electrode and produces an electrical current output proportional to the H<sub>2</sub>S concentration in the gas phase. The sensor's signal output is linear over all measuring ranges and remains virtually constant over its useful life. The sensor requires no maintenance and is easily and safely replaced at the end of its useful life.

Proprietary advancements in the design and chemistry of the sensor's components add significant advantages to this extremely versatile H<sub>2</sub>S sensing technology. The sensor maintains its accuracy to within +/-5% of its span (it does not sleep during continuous use; a typical symptom seen with conventional electrochemical H<sub>2</sub>S sensors) over a 1-3 months period. To maintain accuracy over the useful life of the sensor, calibration of the sensor every 30 days is recommended. Under normal use, the sensor is expected to last from 18-24 months.

The H<sub>2</sub>S sensor recovers from an upset condition (exposure to very high H<sub>2</sub>S) to low PPM level in a matter of few minutes.

**NOTE- Check the product label for safe operating conditions**



## Electronic

The signal generated by the sensor is processed by state of the art low power micro-processor based digital circuitry. The first stage amplifies the signal. The second stage eliminates the low frequency noise. The third stage employs a high frequency filter. The result is a very stable signal that reflects H<sub>2</sub>S concentration in the sample very accurately. Response time of 90% of full scale is less than 60 seconds on all ranges (actual experience may vary due to the integrity of sample line connections, dead volume and flow rate selected) under ambient analysis conditions. Sensitivity is typically 0.5% of full scale of the low range. The display has the resolution of 0.1 PPM H<sub>2</sub>S (on 0-20 PPM Full scale range). The analog output signal may be recorded by an external device via the 4-20 mA or optional 1-5V signal.

## Sample System

The standard GPR-7500AIS is supplied without a sample conditioning system thereby giving users the option of adding their own or purchasing a factory designed sample conditioning system, see section 2 QC Certification for optional equipment ordered. Whatever the choice, the sample must be properly conditioned before introducing it to the transmitter sampling system to ensure accurate measurements.

The GPR-7500AIS is generally supplied with a minimum of a sample flow control valve and a sample flow meter, a coalescing filter installed at the sample inlet, air flow meter and air supply pump. A pressure regulator, with or without a pressure gauge is also available as an option. Users interested in adding their own sample conditioning system should consult the factory. Advanced Instruments Inc. offers a full range of sample handling, conditioning and expertise to meet your application requirements. Contact us at 909-392-6900 or e-mail us at [info@aii1.com](mailto:info@aii1.com) for recommendation.

## Calibration and Accuracy Overview

**Single Point Calibration:** As previously described, the electrochemical H<sub>2</sub>S sensor generates an electrical current proportional to the H<sub>2</sub>S concentration in the sample gas. In the absence of H<sub>2</sub>S the sensor exhibits an absolute zero, e.g. the sensor does not generate a current output in the absence of H<sub>2</sub>S. Given these linearity and absolute zero properties, single point calibration is possible.

**Sample Pressure:** Since the sensor is sensitive to the partial pressure of H<sub>2</sub>S in the sample gas, the output is a function of the number of molecules of H<sub>2</sub>S per unit volume. When sample is vented to the atmosphere the sensor essentially remains at atmospheric pressure. However, a positive or negative pressure on the sensor will alter the output of the sensor and unless the sensor is calibrated under the same analysis conditions, a significant error in measurements will occur. To maintain a constant Sample flow, regulate the pressure between 5-30 PSIG.

**CAUTION:** Any blockage of the sample vent line will cause an increase in the pressure at the sensor thus causing erroneous readings. If sample is to be vented into a pipe above atmospheric pressure, a pressure regulator set at 0.2 PSIG must be installed to maintain constant pressure on the sensor. For vent pressure above 0.2 PSIG, consult factory for proper selection of electronics.

**Ambient Temperature:** The rate at which H<sub>2</sub>S molecules diffuse into the sensor is controlled by a Teflon membrane otherwise known as an 'H<sub>2</sub>S diffusion limiting barrier'. All diffusion processes are temperature sensitive, therefore, the fact that the sensor's electrical output will vary with temperature is normal. Under typical applications, this variation is relatively constant and the measurement accuracy remains within the published specifications over the recommended operating range of temperature. The accuracy of  $\pm 5\%$  or better over an operating temperature range e.g., 5-45°C can be obtained. The measurement accuracy will be the highest if the calibration and sampling are performed at similar temperatures (a temperature variation of 10 °C may produce an error of  $> \pm 2\%$  of full scale).

**Accuracy:** In light of the above parameters, the overall accuracy of a transmitter is affected by two types of errors, 'percent of reading errors', illustrated by Graph A below and the 'percent of full scale errors', illustrated by Graph B. The percent of reading error is contributed by incorrect calibration procedure whereas the percent of full scale error is contributed by tolerance in components and the measurement device. These errors are 'spanned out' during calibration, especially when span calibration is done close to the top end of the measuring range followed by a zero calibration.

Graph C illustrates these 'worse case' specifications that are typically used to develop an overall accuracy statement of  $< 2\%$  of full scale at constant temperature or  $< 5\%$  over the operating temperature range. The QC testing error at the factory is typically  $< 1\%$  of full scale.

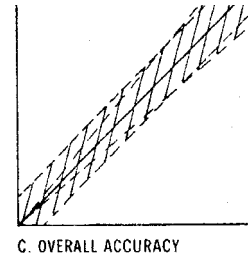
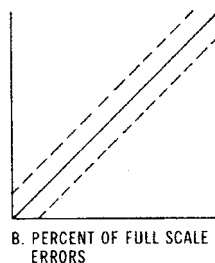
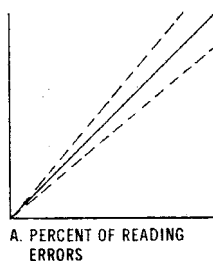

**Example 1:** Graph A, percent of reading error, this error is more pronounced when a span adjustment is carried out at the lower end of the scale, e.g., when span calibration is done by 20 PPM span gas on a 100 PPM full scale range, any error at 20 PPM span gas would be multiplied by a factor of 5 (100/20) when making measurements close to 100 PPM. Conversely, an error during a span adjustment close to the top end of the range, e.g., at 100 PPM would reduce the error proportionately for measurements near the bottom end of the range.

Graph B represents a constant error over the entire measuring range. This error is generally associated with the measuring e.g., LCD and or calibrating devices, e.g., current simulator or current/voltage measuring devices.

Graph C shows the overall accuracy of the measurement.

**Potential Explosion Hazard – See warning in Section 4 – Features and Specifications**

## Mounting of the Transmitter

The GPR-7500AIS transmitter consists of two interconnected enclosures. This configuration is designed to be mounted directly to any flat vertical surface, wall or bulkhead plate by using eight (4) of the appropriate screws.

To facilitate servicing the interior of the transmitters, secure the back plate to a vertical surface approximately 5 feet from the floor or a level accessible to service personnel. This requires the user to supply four (4) additional proper size screws and anchors.



**Caution:** Do not remove or discard the gaskets from either the Ex enclosure or the fiberglass enclosure. Failure to reinstall either of the gaskets will void the NEMA 4, UL Type 3R rating and the immunity to RFI/EMI.

The transmitters design provides immunity from RFI/EMI by maintaining a good conductive contact between the two halves of the enclosures via a conductive gasket (the smaller enclosure containing signal processing electronics). The surfaces contacting the conductive gasket are unpainted. Do not paint these areas. Painting will negate the RFI/EMI protection.



As a safety, connect the vent line of transmitter to a vent pipe for safe venting of sample gas.

Keep the drain valve of coalescing filter closed during normal operation. To drain liquid, open the drain valve. After draining the liquid, turn the drain valve off.



Sample system shown with Sample, Air flow meters

Coalescing filter drain valve

Enclosure containing air pump



Do not leave the drain valve open when the drain outlet is not connected to a vent pipe. Failure to do so will cause H<sub>2</sub>S to leak into atmosphere and cause potential hazard.

**See Section 4 – Features and Specifications, for exclusions**

---

## Gas Connections

The GPR-7500AIS with its standard flow through configuration is designed for positive pressure samples and requires connections for an incoming sample and an outgoing vent line. A span inlet ports is offered as part of the sample systems. The user is responsible for calibration gases and other required components, see below.

**CAUTION:** Before allowing the Sample gas to flow through the transmitter, make sure the Air Pump (housed in a separate Ex enclosure) is powered up and the air flow is set at 1 SCFH. Under rare conditions, you may need to adjust potentiometer (adjacent to the pump ON/OFF switch to adjust the pump speed to ensure a constant 1 SCFH air flow.

**Note:** For ranges above 100 PPM, the sample to air ratio is set at 1;5 (for example, sample flow set at 0.4 SCFH and air flow set at 2 SCFH) and must be maintained during sampling as well as during calibration.

## Procedure

**Caution:** Do not change the factory setting until instructed to do in this manual.

1. Connect the sample to SAMPLE and vent to the VENT as marked on the panel.
2. Regulate the sample pressure as described in "Pressure and Flow" section above.
3. Connect a 3/8" vent line to the compression fitting to be used for venting the SAMPLE.
4. Connect a 1/4" sample line to the compression fitting to be used to bring SAMPLE gas to the transmitter.
5. Connect span gas to SPAN port of the transmitter
6. Turn the air pump ON and set the air flow to 1 SCFH (2 SCFH for ranges above 100 PPM)
7. Set the SAMPLE and SPAN gas pressure between 5-30 psig, keep the sample and span gas pressure within 5 PSIG of each other for a better gas flow control..
8. Select sample gas and allow it to flow through the transmitters and set the flow rate to 1 SCFH (0.4 SCFH for ranges above 100 PPM).
9. Maintain the SAMPLE and AIR flow rates at 1 SCFH to keep sample to air ratio at 1:1 (1;5 ratio for ranges above 100 PPM)



**As a safety, connect the vent line of transmitter to a vent pipe for safe venting of sample gas**



# Electrical Connections

The Incoming power, alarm relays, and signal output connections are made to terminal blocks mounted on a PCB located in the explosion proof enclosure.



Do not supply voltage above the noted value in this manual and noted near the power input terminal of the transmitter.

The PCB in the explosion proof enclosure contains a power limiting intrinsic safety barrier that limit the total power available at the PCB electronics mounted in the general purpose enclosure.

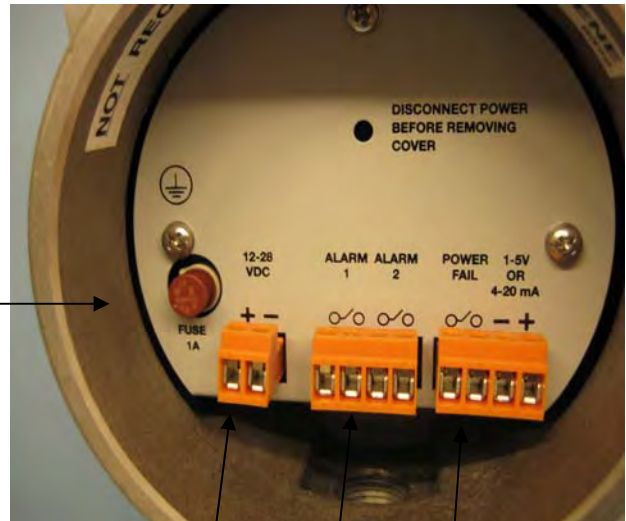

1A Fuse

Power In Alarms Signal Out

The GPR-7500-AIS meets the intrinsic safety standards required for use in Class I, Division 1, Group C, D hazardous areas. ATEX Directive 94/9/EC



Ex d ib IIB T4 Gb  
T<sub>amb</sub> -20°C to +50°C

For USA and Canada, it conforms to

UL 913, 7<sup>th</sup> Edition  
CSA C22.2 No. 157-92

The A-1166 AIS PCB in the Ex enclosure contains five fuses, one plug-in (brown color) rated at 200 mA and the rest are mounted on the PCB (after the DC voltage is regulated to lower safe value, these fuse meet barrier network standard EN 50020).

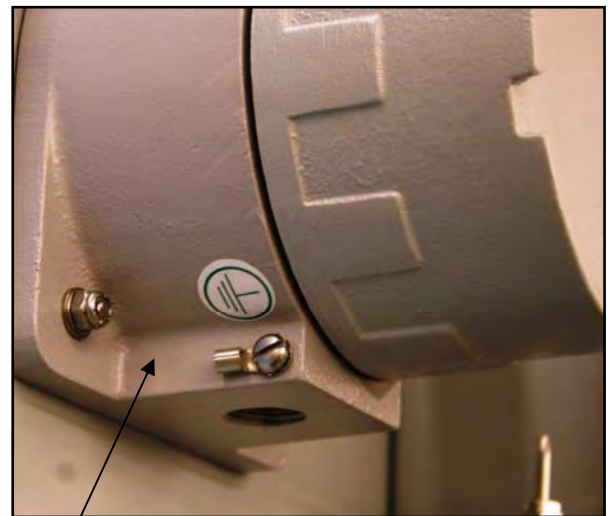

Analyzer ground terminal must be connected to ground



Avoid electrostatic discharge – Clean all surfaces with a damp cloth only.

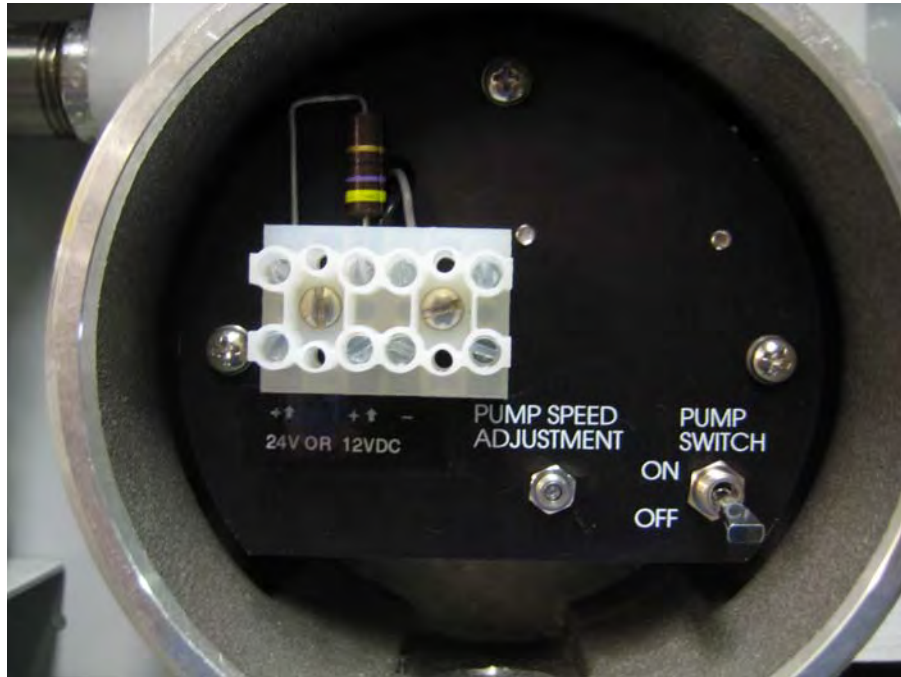

Air pump power connection, pump speed adjustment and power ON/OFF

The power to the Air Pump is to be provided separately and must run through an approved conduit. Pump is set to accept 12 or 24 VDC, ensure that 12 VDC power is connected to 12 VDC terminal or if 24 VDC is used, it is connected to 24 VDC terminal.

After establishing power, turn the pump switch to ON position.

In rare cases, the user may need to adjust the pump speed to get proper air flow. If an adjustment is needed, open the air flow meter completely and turn the potentiometer clockwise or anti-clockwise until the air flow is 2 SCFH. Leave the potentiometer at the set position and adjust the air flow to 1 SCFH (2SCFH for ranges above 100 PPM).

**Secure the lid of the Ex enclosure after establishing power.**

## Hazardous Area Installation

The GPR-7500AIS may be installed in a hazardous area when adhered to the recommended installation procedure delineated above mentioned directives; see page 6.

### Power Input

A 12-28 VDC power supply with a shielded power cable is recommended. The power cable to the Ex enclosure must be supplied through a conduit approved for use in hazardous area. Secure the wires to the power input terminal block by using the integral screws of the terminal block. Do not substitute terminal screws.

Power to air pump requires 12 or 24 VDC and must run through a separate conduit approved for hazardous area.



**CAUTION:** Check the QC for the proper power requirement. Incorrect power will severely damage the transmitter

### Output Connections

The transmitter has two adjustable alarms, one power fail alarm and 4-20 mA or 1-5 VDC signal output connections.

**CAUTION:** The 4-20mA circuit does not require external power. Supplying external power to the PCB will permanently damage the PCB.

The HI and LOW alarms are user configurable. The relays are rated at 1A @ 230 VAC.

**CUTION:** Do not exceed the recommended rating of the relays. Excessive power through the relays can severely damage the relays and the PCB.

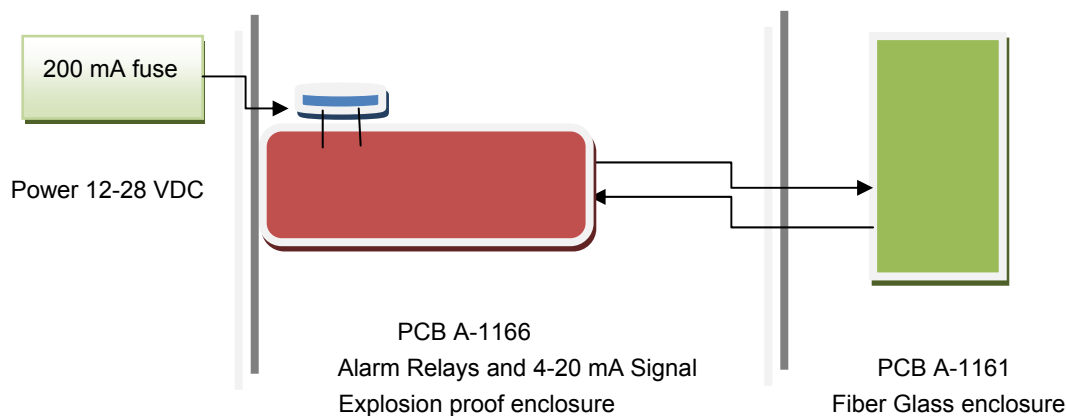

There are total five wire connections between the Ex enclosure and the fiber glass enclosure but for simplicity, only two connections are shown.

### Procedure

1. Unscrew the cone shaped cover from the EX enclosure.
2. Separate the shielding from the wires of the cables.
3. Strip the end of wires no greater than 1/4"
4. Insert the stripped end of wires into the appropriate slots of the terminal block
5. Ensure the positive and negative terminals of the power supply are connected to the appropriate terminals of the terminal block as marked.
6. Tighten the screws and ensure the wires are properly secured.
7. Connect the shielding of the cable to the ground screw inside of the enclosure.
8. Follow the same procedure and establish alarm relays and 4-20 mA signal connections with appropriate terminals

- Replace the cover.

**Note:** The male and female power terminals snap together, making it difficult to detach them when connecting the shield to the ground. However, after connecting the shield, ensure that the male terminal is fully inserted and secured into the female terminal block.

## Installation of H2S Sensor

The GPR-7500 AIS Transmitter is equipped with SS sensor housing. The sensor is housed in the fiber glass enclosure. The sensor housing offers ease of replacement of sensor and at the same time prevents any leakage into the system. The sensor is screwed in and makes the seal against the flat surface of the sensor housing with the integral O-ring on the sensor's threaded front end.



**Caution:** DO NOT dissect the sensor. The sensor contains a corrosive liquid electrolyte that could be harmful if touched or ingested, refer to the Material Safety Data Sheet contained in the Owner's Manual appendix. Avoid contact with any liquid or crystal type powder in or around the sensor or sensor housing, as either could be a form of electrolyte. Leaking sensors should be disposed off in a manner similar to that of a common battery in accordance with local regulations.

Should the transmitter come without sensor installed or need to install a new sensor, follow the guidelines give below.

## Procedure

- Turn the power to transmitter OFF.
- Remove the two (2) clamps securing the right side corners and open the door of the fiber glass enclosure.
- Remove the PCB along with the ribbon cable from the top of the sensor by gently pulling the connector on the sensor PCB.



Avoid electrostatic discharge – touch a metal surface with your bare hand before contacting the PCB. Clean all surfaces with a damp cloth only



- Unscrew the sensor by turn the sensor anti clockwise.
- Remove the new sensor from the bag.
- Screw the new sensor in to the sensor housing until finger tight.
- Align 4 pins of the sensor PCB with 4 pins of the sensor and gently push the PCB on to the sensor until it is firmly seated. Ensure that the ribbon cable is firmly attached to the PCB
- If ribbon cable is detached, insert the ribbon cable as shown and then push down the two levers of the connector.

Sensor shown with ribbon cable half inserted showing the conducting bars facing COND on PCB

Levers on side of ribbon cable connector

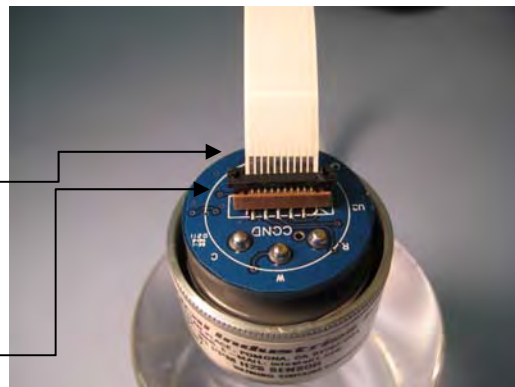

# Span Gas Preparation

**See Section 4 – Features and Specifications, for exclusions**

**Note:** The GPR-7500AIS must be calibrated by using a certified span gas, preferably 50 to 80% of the range of interest or one range above the range of interest.



**Caution:** Do not inhale the H<sub>2</sub>S span gas. If the transmitter is installed in an enclosed area, when using a span gas, ensure the area is being ventilated by circulating air to flush out H<sub>2</sub>S.

## Required Components

1. Certified span gas cylinder with an H<sub>2</sub>S concentration, balance nitrogen or air, approximating 50-80% of the full scale of the measuring range or one range above the intended measuring range. For example, for analysis on 0-100 PPM range, use a span gas with H<sub>2</sub>S concentration ranging from 50-80 PPM
2. A pressure regulator to set the span gas pressure between 5 and 30 psig.
3. Suitable tube fittings and a 4-6 ft. length of metal tubing to connect the pressure regulator outlet to tube fitting designated as SPAN IN on the transmitter panel.

## Procedure

1. With the span gas cylinder valve closed, install the pressure regulator on the cylinder.
2. Keep the regulator's exit valve closed and open the cylinder's control knob slowly.
3. Open the cylinder valve completely.
4. Set the pressure between 5-30 psig using the pressure regulator's control knob.
5. Connect the span gas cylinder outlet to the SPAN port of the transmitter
6. Open the pressure regulator exit valve.
7. Set the span gas flow to 1 SCFH (0.4 SCFH for ranges above 100 PPM)

**Caution:** Do not exceed the recommended flow rate.

## Establishing Power to Electronics

Once the two power input wires of the shielded cable are properly connected to the terminals inside the Ex enclosure as described above, connect the other end of the two wires to a suitable 12-28 VDC power source such as a battery, PLC, DCS, etc.

The digital display responds instantaneously. The transmitter performs several self-diagnostic system status checks termed as "START-UP TEST" as illustrated below:

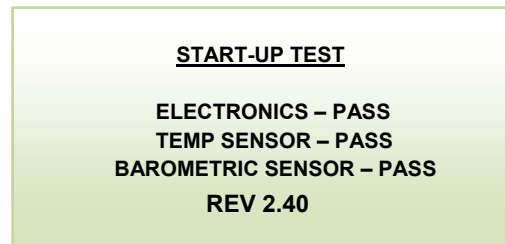

After self diagnostic tests, the transmitter turns itself into the sampling mode. And displays H<sub>2</sub>S contents the sensor is exposed to, the analysis range, the ambient temperature and pressure, High and Low alarm set points.

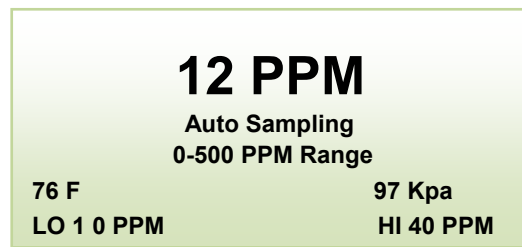

## Manu Navigation

The four (4) pushbuttons located on the front of the transmitter control the micro-processor functions:

Blue ENTER (select)

Yellow UP ARROW

Yellow DOWN ARROW

Green MENU (escape)

## Main Menu

To access the MAIN MENU, press the MENU (ESC) key and the following screen will appear.

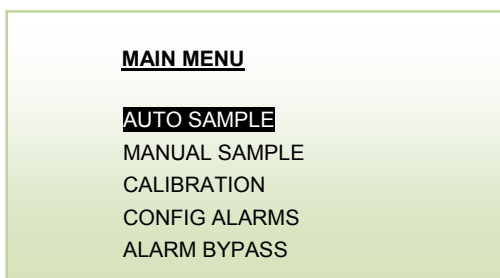

This screen shows various options available. You can use the UP and DOWN arrow key to move the cursor and highlight the desired function. After moving the cursor to the desired function, press ENTER to access that function.

## Range Selection

The GPR-7500 AIS transmitter is equipped with three (3) standard measuring ranges (see specification) and provides users with a choice of sampling modes. By accessing the MAIN MENU, users may select either the AUTO SAMPLING (ranging) or MANUAL SAMPLING (to lock on a single range) mode.

**Note:** For calibration purposes, use of the AUTO SAMPLE mode is recommended. However, the user can also select the MANUAL SAMPLE mode for calibration but the span gas must not exceed the full scale of the manual range selected – for example, a span gas with 15 PPM H<sub>2</sub>S concentration in nitrogen would dictate the use of the 0-20 PPM full scale range for calibration.

## Auto Sampling

1. Access the MAIN MENU by pressing the MENU key.
2. Advance the reverse shade cursor using the ARROW keys to highlight AUTO SAMPLE.
3. Press the ENTER key to select the highlighted menu option.

The display returns to the sampling mode:

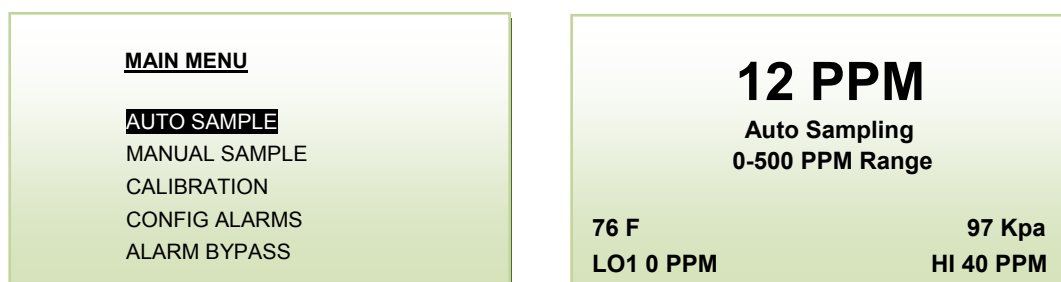

4. The display will shift to the next higher range when the H<sub>2</sub>S reading exceeds 99.9% of the upper limit of the current range. The display will shift to the next lower range when the H<sub>2</sub>S reading drops to 85% of the next lower range. For example, if the transmitter is reading 30 PPM on the 0-50 PPM range and an upset occurs, the display will shift to the 0-100 PPM range when the H<sub>2</sub>S reading exceeds 50 PPM. Conversely, once the upset condition is corrected, the display will shift back to the 0-50 PPM range when the H<sub>2</sub>S reading drops to 40 PPM (85% of 50 PPM).

## Manual Sampling

1. Access the MAIN MENU by pressing the MENU key.
2. Advance the reverse shade cursor using the ARROW keys to highlight MANUAL SAMPLE.
3. Press the ENTER key to select the highlighted menu option.

The following display appears:

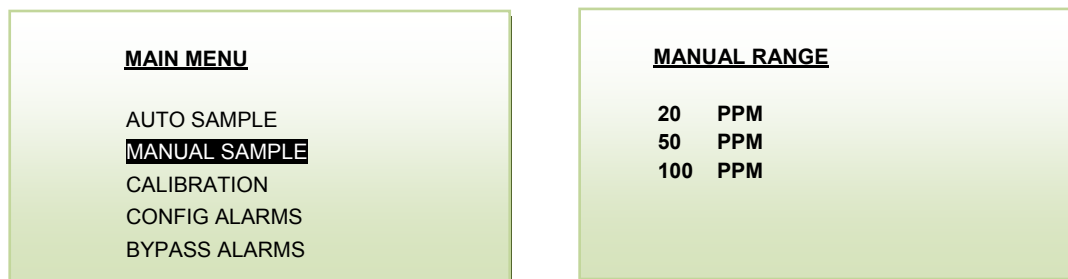

4. Advance the reverse shade cursor using the ARROW keys to highlight the desired MANUAL RANGE.
5. Press the ENTER key to select the highlighted menu option.

The following display appears with the range selected and oxygen concentration of the sample gas:





**Note:** Regardless of the value of the standard used, the span calibration process takes approximately 10-15 minutes

## Factors to Consider when calibrating the transmitter

1. All electrochemical sensor based transmitters/transmitters require periodic calibration, e.g. weekly intervals to a 3 month maximum, to ensure accuracy and ascertain the integrity of the sensor
2. For optimum accuracy, calibrate the transmitter at or close to the temperature and pressure/flow rate of the sample gas
3. A new sensor would require 30-60 minute settling time after installation before commencing calibration. If a sensor has been in service, calibration can be performed at any selected time.
4. For optimum accuracy, the span gas should be approximate 50-80% of the full scale range of analysis or one range above the analysis range, e.g. 50-80 PPM on the 0-100 PPM range.
5. Use of span gas less than 50% of the full scale range of measurements will introduce an “expanding error” (as illustrated by Graph A in Example 1 in the Accuracy section above) close to the top end of the range.

## Zero Calibration Procedure

Normally, zero calibration is performed when a new sensor is installed. Before performing ZERO calibration, it is highly recommended to perform a factory default zero (see details later in this section). This will eliminate any previous zero offset adjustment. With factory default setting, a zero offset less than 25% of the lowest range indicates that the integrity of the sensor and electronics is intact. To perform ZERO calibration

1. Access the MAIN MENU by pressing the MENU key.
2. Advance the reverse shade cursor using the ARROW keys to highlight CALIBRATION.
3. Press the ENTER key to select the highlighted menu option.

The following displays appear:

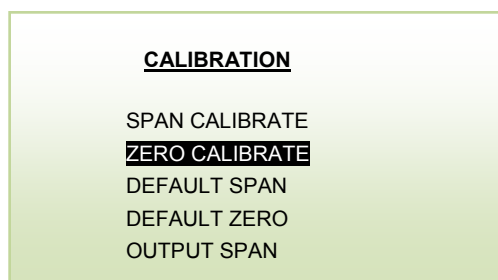
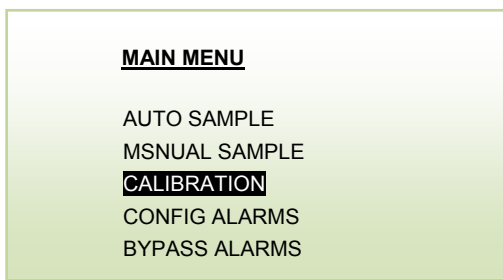

4. Advance the reverse shade cursor using the ARROW keys to highlight ZERO CALIBRATE.
5. Press the ENTER key to select the highlighted menu option.

The following displays appear:

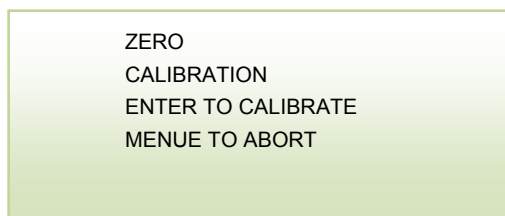

6. Press the ENTER key to calibrate or MENU key to abort and return to SAMPLING mode.
7. Wait for approximately 60 seconds or until the reading has stabilized. If the offset is less than 25% of the lowest range, by pressing ENTER, a message PASSED CALIBRATION will appear and the transmitter will return to the Sample mode. On the other hand, if the offset is above 25% of the lowest range, pressing ENTER, a message FAILED CALIBRATION will appear and the transmitter will return to Sample mode without completing the Zero calibration.

When in calibration, both the Zero Calibrate and Span Calibrate functions, pressing ENTER will result in one of the following displays:

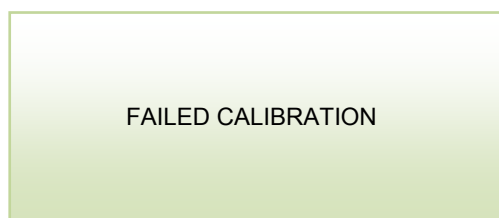
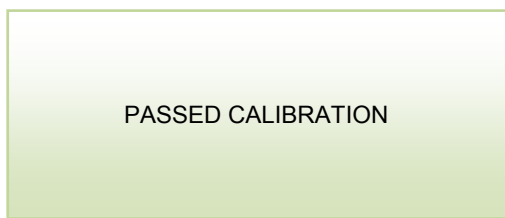

## Factory Default Zero Calibration

The feature will eliminate any previous zero calibration and displays the actual signal output of the sensor. For example, assuming a zero gas is introduced, the display above 0.00% will reflect an actual zero offset. This feature allows the user to ensure that the accumulative zero offset never exceeds 25% of the lowest range limit. To perform Default Zero,

1. Access the MAIN MENU by pressing the MENU key.
2. Advance the reverse shade cursor using the ARROW keys to highlight CALIBRATION.
3. Press the ENTER key to select the highlighted menu option.

The following displays appear:

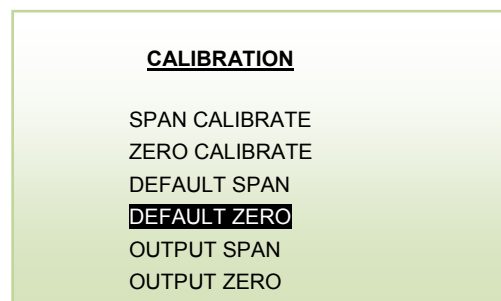
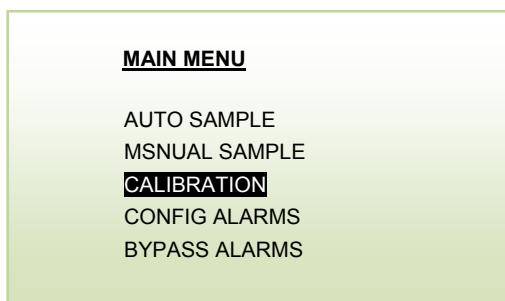

4. Advance the reverse shade cursor using the ARROW keys to highlight DEFAULT ZERO.
5. Press the ENTER key to select the highlighted menu option.

The following display appears and after 3 seconds the system returns to the SAMPLING mode:

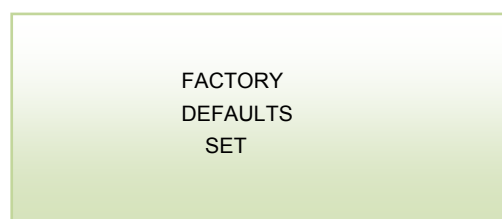

## Span Calibration Procedure

This procedure assumes a span gas under positive pressure. Set the span gas and air flow at 1 SCFH (maintaining the sample/span gas to air ratio at 1:1 (**set sample/span rate at 0.4 SCFH and air flow rate at 2 SCFH to obtain 1:5 ratio for analysis ranges above 100 PPM**))

For calibration purposes, use AUTO SAMPLE mode.

1. Access the MAIN MENU by pressing the MENU key.
2. Advance the reverse shade cursor using the ARROW keys to highlight AUTO SAMPLE.
3. Press the ENTER key to select the highlighted menu option.

The following displays appear:

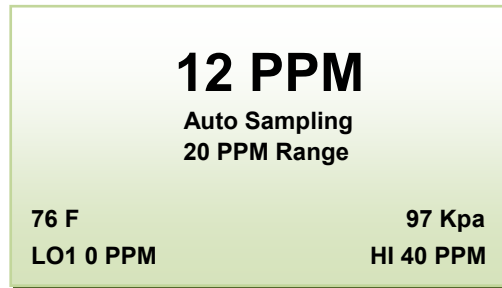
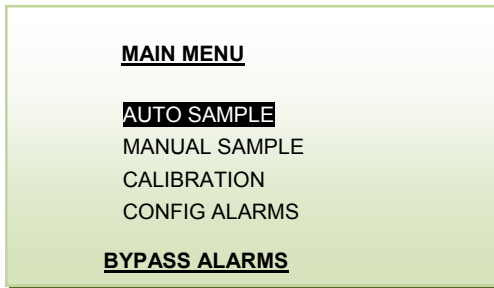

4. Return to the MAIN MENU by pressing the MENU key.
5. Advance the reverse shade cursor using the ARROW keys to highlight CALIBRATION.
6. Press the ENTER key to select the highlighted menu option.
7. Repeat to select SPAN CALIBRATE

The following displays appear:

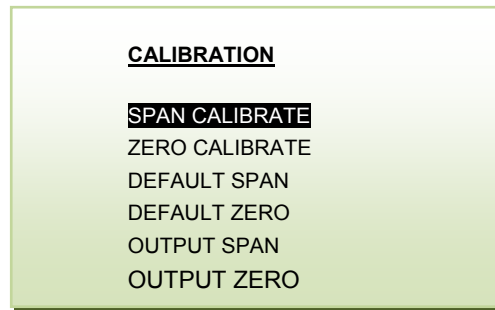
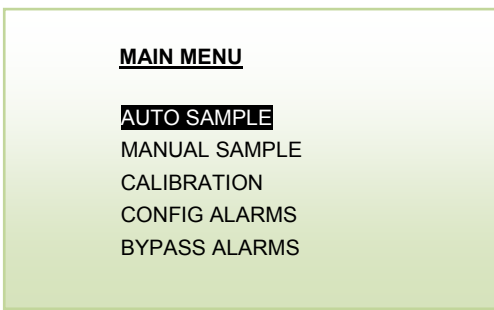

8. After selecting the SPAN CALIBRATION, the following displays appear:

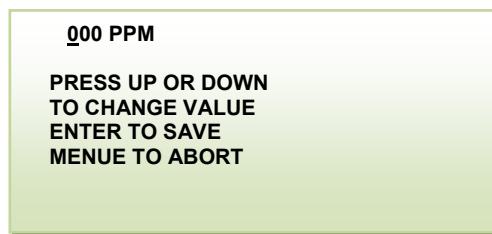

9. Use UP/DOWN key to enter the value of the first digit. Press the ENTER key to advance the underline cursor right or MENU key to advance the underline cursor left to reach to the desired digit.
10. Repeat until the complete span value has been entered and press ENTER. The following display will appear showing the real time H<sub>2</sub>S concentration..

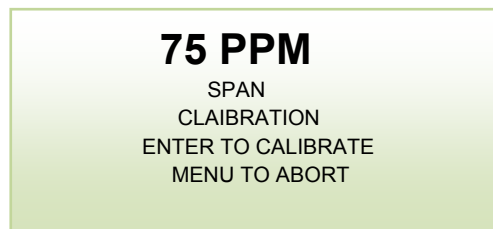

11. Wait until the transmitter reading has stabilized and the press ENTER key to accept SPAN CALIBRATION. After successful calibration, the transmitter will display a message “PASSED CALIBRATION” and return to the Sample mode.

**NOTE:** The transmitter is allowed to accept calibration only when H<sub>2</sub>S reading is within -30% +50% of the span gas value. If the H<sub>2</sub>S reading is outside of this limit, by pressing ENTER to accept calibration will result in “FAILED CALIBRATION” and the transmitter will return to the Sample mode without completing Span calibration.

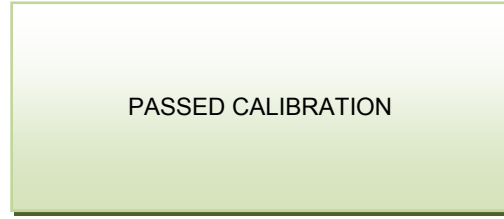
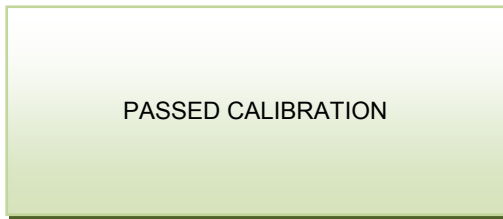

If the calibration is unsuccessful, stay in the SAMPLING mode with span gas flowing through the transmitter, make sure the reading stabilizes, reaches within 30-50% (see below) of the span gas value (after factory default span setting) and repeat the calibration before concluding the equipment is defective.

## Factory Default Span

With factory default span, previous calibration data stored in the memory is removed and the sensitivity of the transmitter is reset to the value based on the average output of the H<sub>2</sub>S sensor at a specific H<sub>2</sub>S concentration. For example, with factory default settings, when a span gas is introduced, the micro-processor will display H<sub>2</sub>S reading within 30-50% of the span gas value, indicating that the sensor output is within the specified limit.

1. Access the MAIN MENU by pressing the MENU key.
2. Advance the reverse shade cursor using the ARROW keys to highlight CALIBRATION.
3. Press the ENTER key to select the highlighted menu option.

The following display appears:

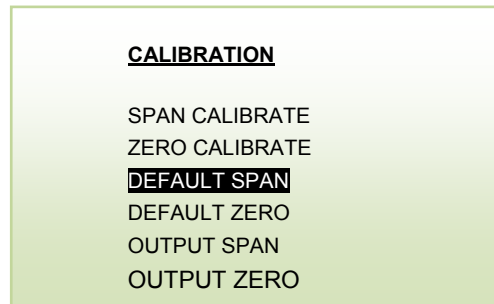
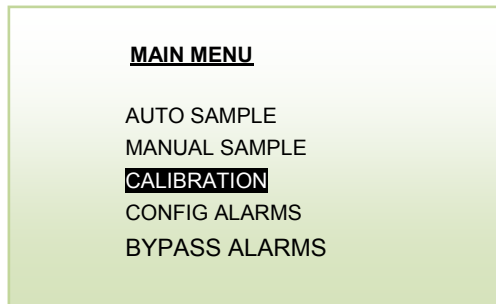

4. Advance the reverse shade cursor using the ARROW keys to highlight DEFAULT SPAN.
5. Press the ENTER key to select the highlighted menu option.

The following displays appear and after 3 seconds the system returns to the SAMPLING mode:

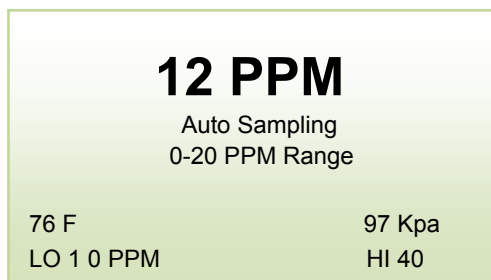

## Adjustment of 20 mA Analog Output

In rare instances the 4-20mA signal output may not agree to the reading displayed by the LCD. This feature enables the user to adjust the 20mA signal output should the LCD display not agree.

**Note:** Adjust the 4mA signal output with the OUTPUT ZERO option described above.

1. Access the MAIN MENU by pressing the MENU key.
2. Advance the reverse shade cursor using the ARROW keys to highlight CALIBRATION.
3. Press the ENTER key to select the highlighted menu option.

The following displays appear:

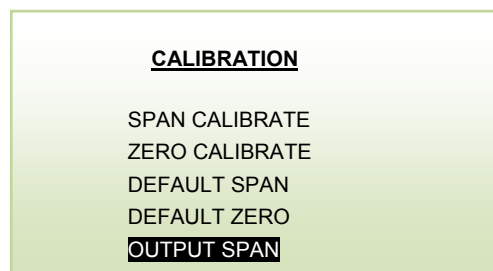
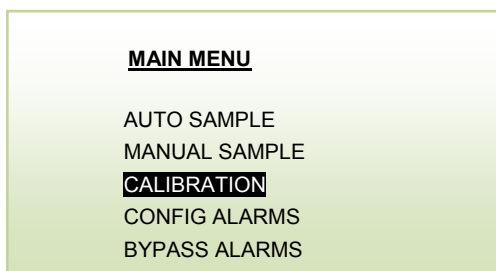

4. Advance the reverse shade cursor using the ARROW keys to highlight DEFAULT SPAN.
5. Press the ENTER key to select the highlighted menu option.

The following display appears

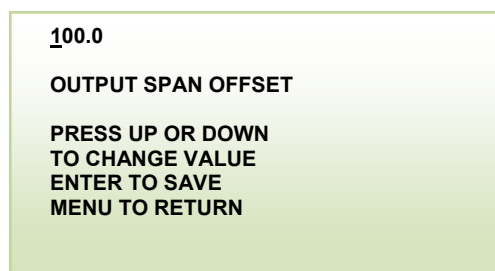

6. The default setting of 100 illustrates no adjustment to the analog output signal. Adjust the initial value to above 100 to increase the 20 mA analog signal value or decrease it below 100 to decrease the 20 mA analog signal.
7. Press the ENTER key to advance the underline cursor right or press the MENU key to advance the underline cursor left to reach to the desired digit of the OUTPUT SPAN OFFSET value.
8. Press the ARROW keys to enter the desired digit. After entering the digit press ENTER and the 20 mA signal will adjust to the new value.
9. If the 20 mA signal still does not match with 20 mA signal, repeat steps 7 through 8 the 20 mA matches with the display..
10. Save the adjustment value by pressing the ENTER key or abort by pressing the MENU key.

The system returns to the SAMPLING mode.

## Sampling

After Zero/Span calibration the transmitter is now ready to analyze the sample gas. Set the sample flow rate and air flow rate as recommended above. During sampling, sample gas is continuously blended with air to supply sufficient oxygen to the sensor to perform. The ratio of sample to air flow must be maintained as recommended at all times. The analysis data, 4-20 mA or 1-5 VDC signal output can be recorded on any conventional data recording device..

## Setting Alarms

The transmitter is equipped with two programmable alarm relays. The two alarms set points are user adjustable and can be set either as LOW/HIGH, LOW/LOW or HIGH/HIGH.

## Setting Alarm Delays

Alarm delay option allows the user to ignore the alarm should a sudden short spike in the oxygen reading occurs.

## Setting Alarm Bypass

The alarms bypass feature allows the user to bypass the alarm during trouble shooting/repair or test run. However, once the alarm bypass is selected, alarm will remain disabled even if the oxygen reading is over/under the alarm set point. The alarm will re-arm itself only after the fault condition has been reverted.

The alarms are automatically disabled during SPAN/ZERO calibration.

The relays are rated at 1A @ 230V.

**CAUTION;** When using these relays, do not exceed the recommended rating.

## Standby

The transmitter has no special storage requirements.

The sensor should remain inside of the sensor housing and connected to the electronics during storage periods. Before turning the transmitter OFF, ensure that sample system is purged with clean ambient air. This will keep the sample system clean and would be ready to use again when required with very short down time.

Store the transmitter with power OFF at a safe location and away from a direct heating source.

If storing for an extended period of time, protect the transmitter from dust, heat and moisture.

## 6. Maintenance

Generally, replacing the sensor periodically or replacing filter element of the coalescing filter is the extent of the maintenance requirements of this transmitter.

**Serviceability:** Except for replacing the sensor, there are no parts inside the transmitter for the operator to service. Only trained personnel with the authorization of their supervisor should conduct maintenance.

## 7. Spare Parts

Recommended spare parts for the GPR-7500 AIS H2S:

Item No.	Description
GPR-11-72-7H-LM	H2S sensor for measuring up to 2000 PPM H2S
GPR-11-72-7HH-LM	H2S Sensor for measuring up to 100 PPM H2S

Other spare parts:

The Factory must be consulted for any other spare parts and questions related to maintenance

## 8. Troubleshooting

Symptom	Possible Cause	Recommended Action
Slow recovery	At installation, defective sensor	Replace sensor if recovery unacceptable or H <sub>2</sub> S reading fails to reach 10% of lowest range
	Air leak in sample system connection(s)	Leak test the entire sample system-correct source of leak
	Damaged in service - electrolyte leakage Sensor nearing end of life	Replace sensor Replace sensor
High H <sub>2</sub> S reading after installing or replacing sensor	Transmitter calibrated before sensor stabilized	Allow H <sub>2</sub> S reading to stabilize before making the span/calibration adjustment
	Air leak in sample system connection(s)	Leak test the entire sample system (above)
	Abnormality in zero gas	Qualify zero gas (using portable transmitter)
High H <sub>2</sub> S reading Sampling	Flow rate exceeds limits	Correct pressure and flow rate
	Pressurized sensor	Remove restriction on vent line
	Improper sensor selection	Install proper sensor



Symptom	Possible Cause	Recommended Action
Response time slow	Air leak, dead legs, distance of sample line, low flow rate, high volume of optional filters and scrubbers	Leak test entire sample system, reduce dead volume or increase flow rate
H <sub>2</sub> S reading doesn't agree to expected values	Pressure and temperature of the sample is different than span gas Error in calibration Abnormality in gas	Calibrate the transmitter (calibrate at pressure and temperature similar to that of sample) Repeat calibration Qualify the integrity of the sample gas (use a portable transmitter as a secondary check)
Erratic H <sub>2</sub> S reading or No H <sub>2</sub> S reading	Sudden Changes in sample pressure  Loose sensor cable and or sensor PCB  Incorrect polarity of ribbon cable  Corroded sensor PCB  Liquid covering sensing area  Sensor nearing end of life	Calibrate the transmitter (calibrate at pressure and temperature similar to that of sample) Maintain sample pressure to within recommended range Secure ribbon cable firmly by fully inserting the ribbon cable into its mating socket on the sensor PCB Ensure that sensor PCB is firmly secured on sensor  Ensure that the conductors of ribbon cable align with COND on sensor PCB  Consult Factory  Replace sensor  Replace sensor
Cannot span calibrate	Incorrect span gas Span gas pressure too high Span flow rate too high Incorrect sensor Sensor nearing end of life	Check span gas with a secondary transmitter Set span gas pressure within recommended range Set flow rate within recommended range Replace sensor
Cannot zero calibrate	Zero offset outside of recommended range High sample/zero gas flow causing back pressure on sensor  Defective sensor	Allow enough time for sensor to settle with zero gas Use ambient air for zero calibration Set sample/zero gas flow within recommended range  Replace sensor

## 9. Warranty

The design and manufacture of GPR Series H2S transmitters/transmitters, monitors and sensors are performed under a certified Quality Assurance System that conforms to established standards and incorporates state of the art materials and components for superior performance and minimal cost of ownership. Prior to shipment every transmitter is thoroughly tested by the manufacturer and documented in the form of a Quality Control Certification that is included in the Owner's Manual accompanying every transmitter. When operated and maintained in accordance with the Owner's Manual, the units will provide many years of reliable service.

### Coverage

Under normal operating conditions, the monitor, transmitters and sensor are warranted to be free of defects in materials and workmanship for the period specified in accordance with the most recent published specifications, said period begins with the date of shipment by the manufacturer. The manufacturer information and serial number of this transmitter are located on the rear of the transmitter. Advanced Instruments Inc. reserves the right in its sole discretion to invalidate this warranty if the serial number does not appear on the transmitter.

If your Advanced Instruments Inc. monitor, transmitter and/or oxygen sensor is determined to be defective with respect to material and/or workmanship, we will repair it or, at our option, replace it at no charge to you. If we choose to repair your purchase, we may use new or reconditioned replacement parts. If we choose to replace your Advanced Instruments Inc. transmitter, we may replace it with a new or reconditioned one of the same or upgraded design. This warranty applies to all monitors, transmitters and sensors purchased worldwide. It is the only one we will give and it sets forth all our responsibilities. There are no other express warranties. This warranty is limited to the first customer who submits a claim for a given serial number and/or the above warranty period. Under no circumstances will the warranty extend to more than one customer or beyond the warranty period.

### Limitations

Advanced Instruments Inc. will not pay for: loss of time; inconvenience; loss of use of your Advanced Instruments Inc. transmitter or property damage caused by your Advanced Instruments Inc. transmitter or its failure to work; any special, incidental or consequential damages; or any damage resulting from alterations, misuse or abuse; lack of proper maintenance; unauthorized repair or modification of the transmitter; affixing of any attachment not provided with the transmitter or other failure to follow the Owner's Manual. Some states and provinces do not allow limitations on how an implied warranty lasts or the exclusion of incidental or consequential damages, these exclusions may not apply.

### Exclusions

This warranty does not cover installation; defects resulting from accidents; damage while in transit to our service location; damage resulting from alterations, misuse or abuse; lack of proper maintenance; unauthorized repair or modification of the transmitter; affixing of any label or attachment not provided with the transmitter; fire, flood, or acts of God; or other failure to follow the Owner's Manual.

### Service

Call Advanced Instruments Inc. at 909-392-6900 (or e-mail [info@aii1.com](mailto:info@aii1.com)) between 7:30 AM and 5:00 PM Pacific Time Monday thru Thursday or 8:00 AM to 12:00 pm on Friday. Trained technicians will assist you in diagnosing the problem and arrange to supply you with the required parts. You may obtain warranty service by returning you transmitter, postage prepaid to:

**Advanced Instruments Inc.**  
**2855 Metropolitan Place**  
**Pomona, Ca 91767 USA**

Be sure to pack the transmitter securely. Include your name, address, telephone number, and a description of the operating problem. After repairing or, at our option, replacing your Advanced Instruments Inc. transmitter, we will ship it to you at no cost for parts and labor.

# 10. MSDS – Material Safety Data Sheet

## Product Identification

Product Name	H2S sensor Series - OSV
Synonyms	Electrochemical Sensor
Manufacturer	Advanced Instruments Inc., 2855 Metropolitan Place, Pomona, CA 91767 USA
Emergency Phone Number	909-392-6900
Preparation / Revision Date	January 1, 1995
Notes	H2S sensors are sealed, contain protective coverings and in normal conditions do not present a health hazard. Information applies to electrolyte unless otherwise noted.

## Specific Generic Ingredients

Carcinogens at levels > 0.1%	None
Others at levels > 1.0%	Acetic Acid or sulfuric acid
CAS Number	Acetic Acid = 64-19-7
Chemical (Synonym) and Family	Potassium Hydroxide (KOH) – Base or Acetic Acid (CH <sub>3</sub> CO <sub>2</sub> H) – Acid, Lead (Pb) – Metal

## General Requirements

Use	Acid - as electrolyte
Handling	Rubber or latex gloves, safety glasses
Storage	Indefinitely

## Physical Properties

Boiling Point Range	Acetic Acid = 100 to 117° C
Melting Point Range	Acetic Acid – NA, Lead 327° C
Freezing Point	Acetic Acid = -40 to -10° C
Molecular Weight	Acetic Acid – NA, Lead = 207
Specific Gravity	Acetic Acid = 1.05 @ 20° C
Vapor Pressure	Acetic Acid = 11.4 @ 20° C
Vapor Density	Acetic Acid = 2.07
pH	Acetic Acid = 2-3
Solubility in H <sub>2</sub> O	Complete
% Volatiles by Volume	None
Evaporation Rate	Similar to water
Appearance and Odor	Aqueous solutions Colorless, vinegar-like odor, sulfuric acid, no odor

## Fire and Explosion Data

Flash and Fire Points	Not applicable
Flammable Limits	Not flammable
Extinguishing Method	Not applicable
Special Fire Fighting Procedures	Not applicable

Unusual Fire and Explosion Hazards Not applicable

### Reactivity Data

Stability Stable  
 Conditions Contributing to Instability None  
 Incompatibility Acid = Avoid contact with strong bases  
 Hazardous Decomposition Products Acid = Emits toxic fumes when heated  
 Conditions to Avoid Heat above 70 degree C

### Spill or Leak

Steps if material is released Sensor is packaged in a sealed plastic bag, check the sensor inside for electrolyte leakage. If the sensor leaks inside the plastic bag or inside transmitter sensor housing do not remove it without rubber or latex gloves and safety glasses and a source of water. Flush or wipe all surfaces repeatedly with water or wet paper towel (fresh each time).  
 Disposal In accordance with federal, state and local regulations.

### Health Hazard Information

Primary Route(s) of Entry Ingestion, eye and skin contact  
 Exposure Limits Acetic Acid - ACGIH TLV / OSHA PEL 10 % (TWA)  
 Ingestion Acetic Acid = Oral LD50 (RAT) = 6620 mg/kg  
 Eye Electrolyte is corrosive and eye contact could result in permanent loss of vision.  
 Skin Electrolyte is corrosive and skin contact could result in a chemical burn.  
 Inhalation Liquid inhalation is unlikely.  
 Symptoms Eye contact - burning sensation. Skin contact - soapy slick feeling.  
 Medical Conditions Aggravated None  
 Carcinogenic Reference Data Acetic Acid = NTP Annual Report on Carcinogens - not listed; LARC Monographs - not listed; OSHA - not listed  
 Other none.

### Special Protection Information

Ventilation Requirements None  
 Eye Safety glasses  
 Hand Rubber or latex gloves  
 Respirator Type Not applicable  
 Other Special Protection None

### Special Precautions

Precautions Do not remove the sensor's protective Teflon and PCB coverings. Do not probe the sensor with sharp objects. Wash hands thoroughly after handling. Avoid contact with eyes, skin and clothing.  
 Empty sensor body may contain hazardous residue.  
 Transportation Not applicable