

# OWL 1280

Model: OW1.7-VS-CL-1280

USER MANUAL

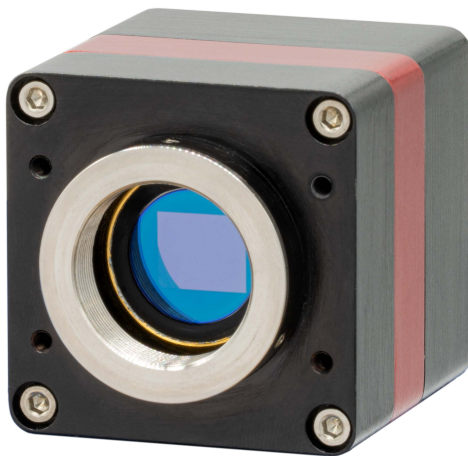

# CONTENT

CONTENT.....	2
1. INTRODUCTION.....	3
2. SPECIFICATION.....	4
3. GETTING STARTED.....	6
4. EPIX XCAP.....	9

## 1. INTRODUCTION

### 1.1 Scope

This manual covers the Owl 1280 digital camera and all applicable components. Raptor recommends that this manual be used to optimize camera operation.

### 1.2 Camera Care

Raptor cameras require no regular maintenance except occasional external cleaning of the sensor window (the glass window between the camera sensor and the microscope or lens). Should any other issues occur please contact your local agent.

To clean the sensor window: gently wipe the face of the sensor window with a small amount of optical grade isopropyl alcohol and lens paper. Apply forced air again to remove any loose particles.

**CAUTION** — The camera's sensor, and circuits are sensitive to static discharge. Ensure you are using a static strap or are completely grounded at all times to release any static energy before you clean the window.

**CAUTION** — Do not use acetone.

### 1.3 CameraLink Cable

If using a CameraLink cable not supplied direct from Raptor, for CE compliance we recommend using a screened CameraLink cable with ferrite (100 ohms at 100MHz) fitted as close to the camera as possible.

## 2. SPECIFICATION

### 2.1 Camera Specification

The OWL 1280 digital camera is designed for high-resolution applications requiring visible to SWIR imaging (600-1700nm). The OWL 1280 camera uses an InGaAs sensor with a resolution of 1280 x 1024 in a 12-bit digital output. High-speed low-noise electronics provide linear response and sensitivity for rapid image capture.

The Camera Link digital interface provides the most stable platform for data transfer and the camera will work on any Camera Link standard card.

A Software Development Kit (SDK) is available for interfacing with custom software.

Sensor Type	InGaAs PIN-Photodiode
Active Pixel	1280 x 1024
Pixel Pitch	10 $\mu$ m x 10 $\mu$ m
Active Area	12.8mm x 10.24mm
Spectral response <sup>1</sup>	0.6 $\mu$ m to 1.7 $\mu$ m
Readout Noise (RMS) <sup>2</sup> LG = Low Gain HG = High Gain	LG: <180 electrons (160 electrons typical) HG: <50 electrons (28 electrons typical)
Peak Quantum Efficiency	>90% @ 1.3 $\mu$ m
Full Well Depth	LG: 450ke- HG: 10ke-
Pixel Operability	>99.5%
Dark Current (e/p/s)	<19,000 @ 15°C
Digital Output Format	12 bit Camera Link (medium configuration)
Exposure time	LG: 10 $\mu$ s to 92.5ms HG: 10 $\mu$ s to 86.5ms
Shutter mode	Global shutter
Frame Rate	10 to 60Hz
Optical Interface	C mount (selection of SWIR lens available)
Dynamic Range	LG: 69dB, HG: 51dB
Trigger interface	Trigger IN and OUT - TTL compatible
Power supply	12V DC $\pm$ 0.5V
TE Cooling	Active
Image Correction	3 point NUC (offset, Gain & Dark Current) + pixel correction
Functions controlled by serial communication	Eg. Exposure, intelligent AGC, Non Uniformity Correction, Gamma, Pk/Av, TEC, ROI, etc
Camera Power Consumption <sup>3</sup>	<8W with TEC ON, NUC ON
Operating Case Temperature <sup>4</sup>	-20°C to +55°C
Storage Temperature	-30°C to +60°C
Dimensions (L*W*H) <sup>5</sup>	67.60mm x 50.00mm x 50.00mm
Weight	247g

Raptor Photonics Limited reserves the right to change this document at any time without notice and disclaims liability for editorial, pictorial or typographical errors. This product is under the export control of UK government and maybe subject to an Single Individual export licence before shipment.

**Note 1:** Optional filters available: Shortpass, Longpass or Bandpass

**Note 2:** Measured in ambient of 25°C with adequate heat sinking

**Note 3:** Extended operating temperature range on request

## 2.2 Mechanical Outline

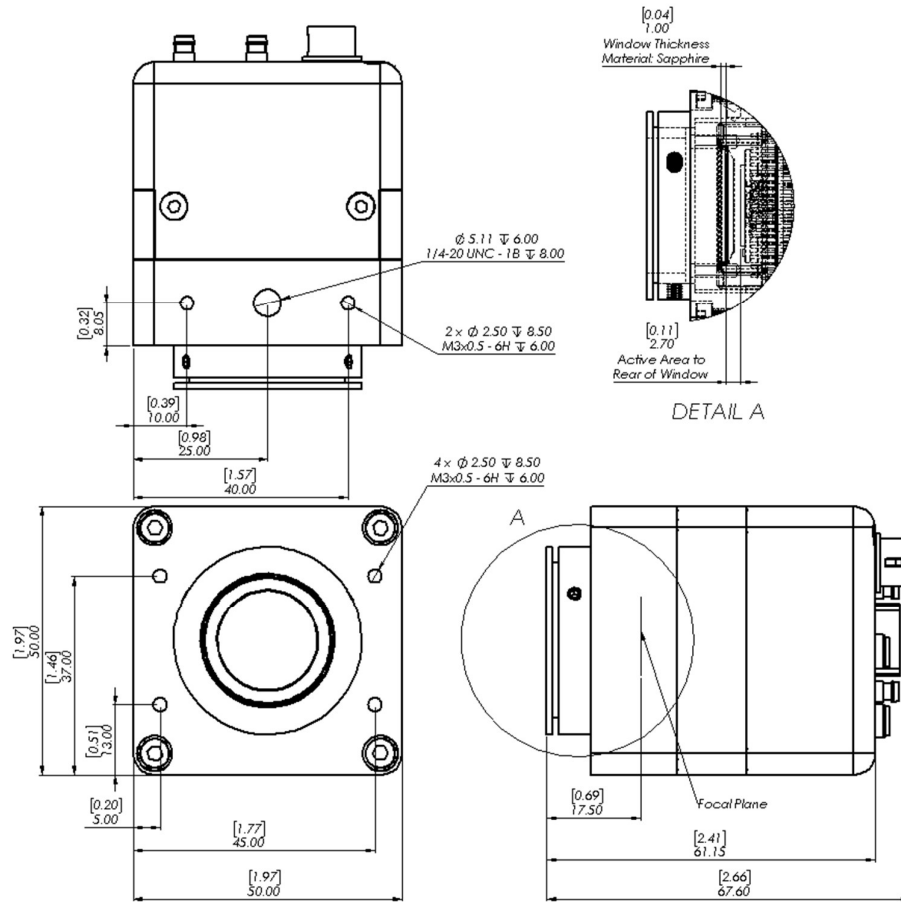

3D drawings (STEP) are available upon request.

### 3. GETTING STARTED

#### 3.1 System Overview

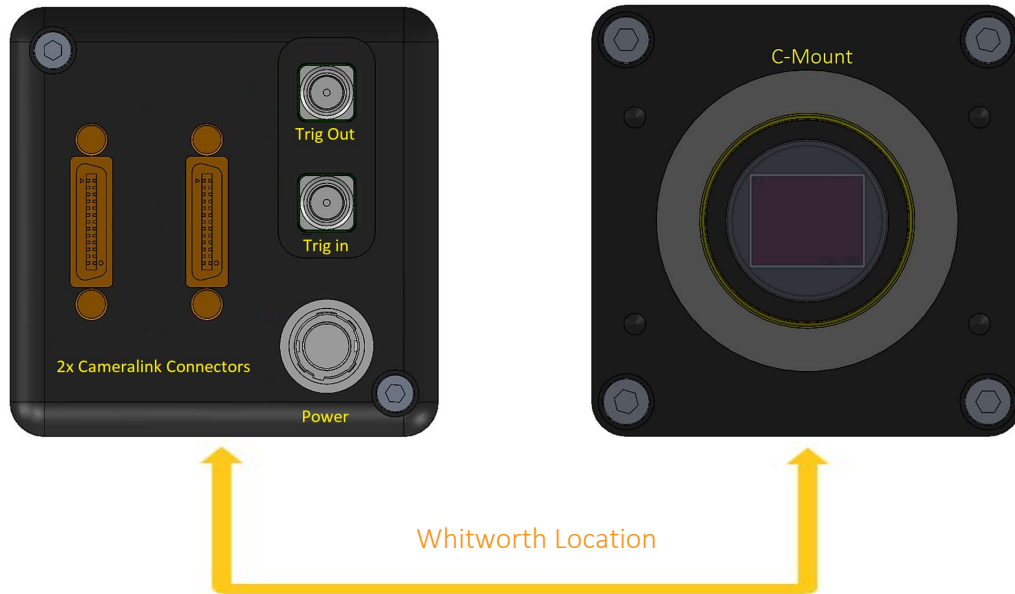

#### 3.2 Mounting to Microscope

The OWL 640 has a standard C-Mount that should easily screw onto any microscope port.

#### 3.3 Mounting to a tripod or optical table

The camera has a ¼-20 BSW (Whitworth), threaded hole to mount to a tripod or an optical table. The image below shows an optical table mount with the ¼-20 BSW thread.

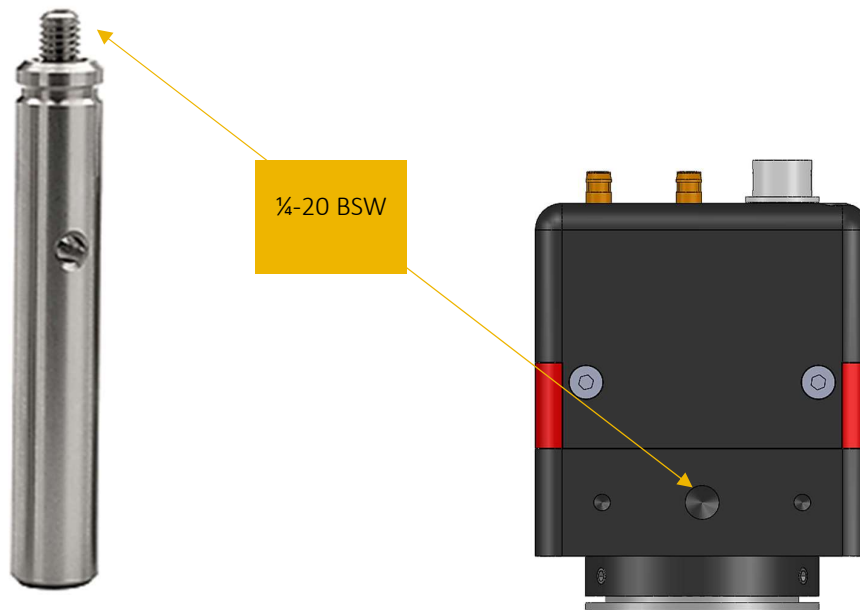

### 3.4 3rd PARTY SOFTWARE

Raptor supports a range of 3<sup>rd</sup> party software packages as per the matrix below.

	XCAP	XCLIB	NI Labview	Micromanager
Hawk 252	<input checked="" type="checkbox"/>	<input checked="" type="checkbox"/>		
Falcon III	<input checked="" type="checkbox"/>	<input checked="" type="checkbox"/>		
Eagle	<input checked="" type="checkbox"/>	<input checked="" type="checkbox"/>	<input checked="" type="checkbox"/>	<input checked="" type="checkbox"/>
Owl 320 High Speed	<input checked="" type="checkbox"/>	<input checked="" type="checkbox"/>		
Owl 640 M	<input checked="" type="checkbox"/>	<input checked="" type="checkbox"/>	<input checked="" type="checkbox"/>	<input checked="" type="checkbox"/>
Owl 640 T	<input checked="" type="checkbox"/>	<input checked="" type="checkbox"/>		
Owl 640 II	<input checked="" type="checkbox"/>	<input checked="" type="checkbox"/>	<input checked="" type="checkbox"/>	<input checked="" type="checkbox"/>
Ninox 640 II	<input checked="" type="checkbox"/>	<input checked="" type="checkbox"/>	<input checked="" type="checkbox"/>	<input checked="" type="checkbox"/>
Owl 1280	<input checked="" type="checkbox"/>	<input checked="" type="checkbox"/>	<input checked="" type="checkbox"/>	
Ninox 1280	<input checked="" type="checkbox"/>	<input checked="" type="checkbox"/>	<input checked="" type="checkbox"/>	

- Software tested by Raptor Photonics

- Software tested by other companies

Blank - The camera has not been tested or is not supported by this software

In this guide, there is a quick overview of XCAP (<http://www.epixinc.com/support/files.php>) and Micro-Manager (<https://micro-manager.org>). Should you have other software support specific needs, please do not hesitate to contact our sales team on [sales@www.raptorphotonics.com](mailto:sales@www.raptorphotonics.com).

### 3.5 Connecting your camera to a computer

- Boot up the computer.
- Insert EPIX software key dongle into a USB port of your PC (the red light on the dongle should light up).
- Use the Camera Link cables to connect the camera to the computer. Where the cable closest to the trigger and power connectors going to the port on the frame grabber closest to the motherboard on the PC.
- We advise using Camera Link cables of length 2m. When using cables of greater length than this, the camera will not perform at its optimum level and will eventually not operate at all.

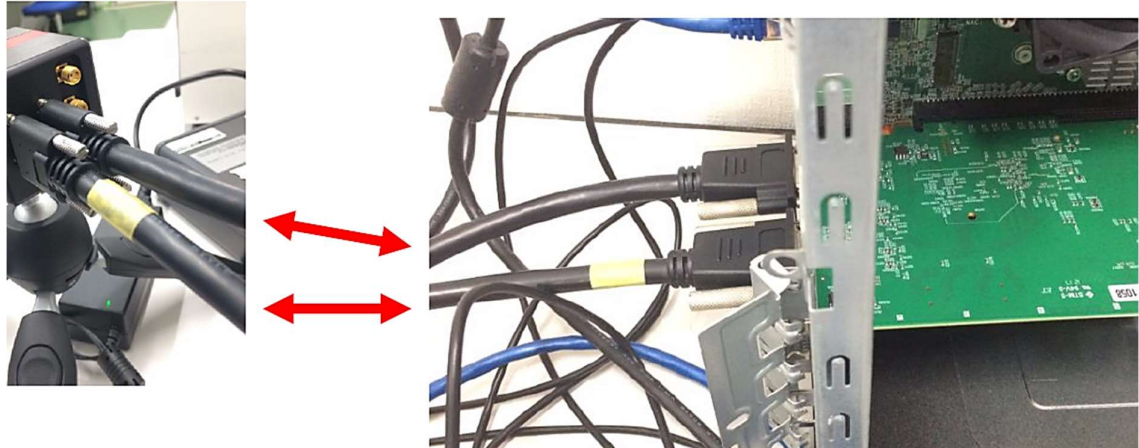

- Carefully thread the C-mount lens onto the camera's lens ring, rotating the lens in a clockwise direction until it is securely fastened. Use the lens controls to adjust focus. We suggest that the camera be mounted on a tri-pod or an optical bench.
- Connect the 12V power supply to the camera.

The Owl 1280 camera is compatible with all types of Camera Link frame grabber. However, our cameras are extensively tested using Epix Inc equipment's XCAP, for this reason we recommend XCAP software.

If using a CameraLink cable not supplied direct from Raptor, for CE compliance we recommend using a screened CameraLink cable with ferrite (100 ohms at 100MHz) fitted as close to the camera as possible.



## 4. EPIX XCAP

For minimum computer system requirements, please contact Epix for the latest information. It is a minimum requirement to use a PIXCI E8 frame grabber. Bit packing must also be switched off in order for the camera to image.

### 4.1 Download and Install XCAP

Using the following link, <http://www.epixinc.com/support/files.php>, please select the appropriate version of XCAP for your computer. Please ensure you are downloading from the section labelled. *Pre-release version with support for the latest cameras and latest PIXCI® imaging boards.* Open the downloaded file when complete and follow the onscreen instructions. Be sure to accept the board driver installation.

### 4.2 Operating your camera using XCAP

1. Open XCAP from within your operating system enabling administrative privileges.
2. Select PIXCI dropdown menu and select PIXCI Open Close, Figure 1 should appear.

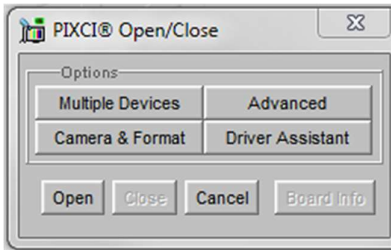

Figure 1: Open / Close

3. Select Close, and then Click on the Camera & Format button.
4. Using the dropdown menu scroll down and select Raptor Photonics OWL 1280 from the list (Figure 2). Selecting OK when done.

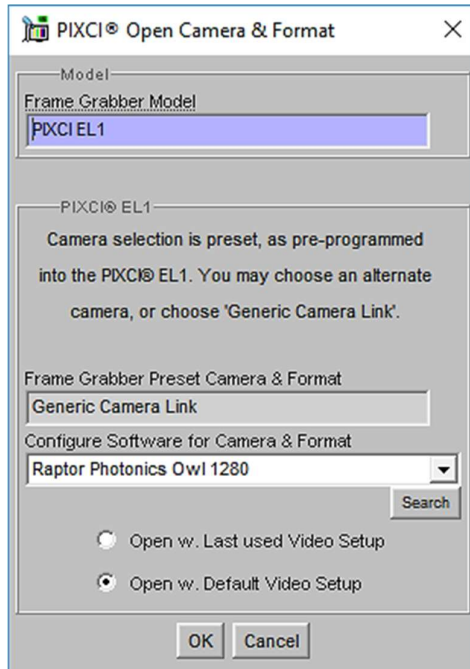

Figure 2: Camera Selection

5. Select Open and the viewing and control screens, Figure 3, will now open. Two windows should open, a viewing window (Left) and a control window (Right).

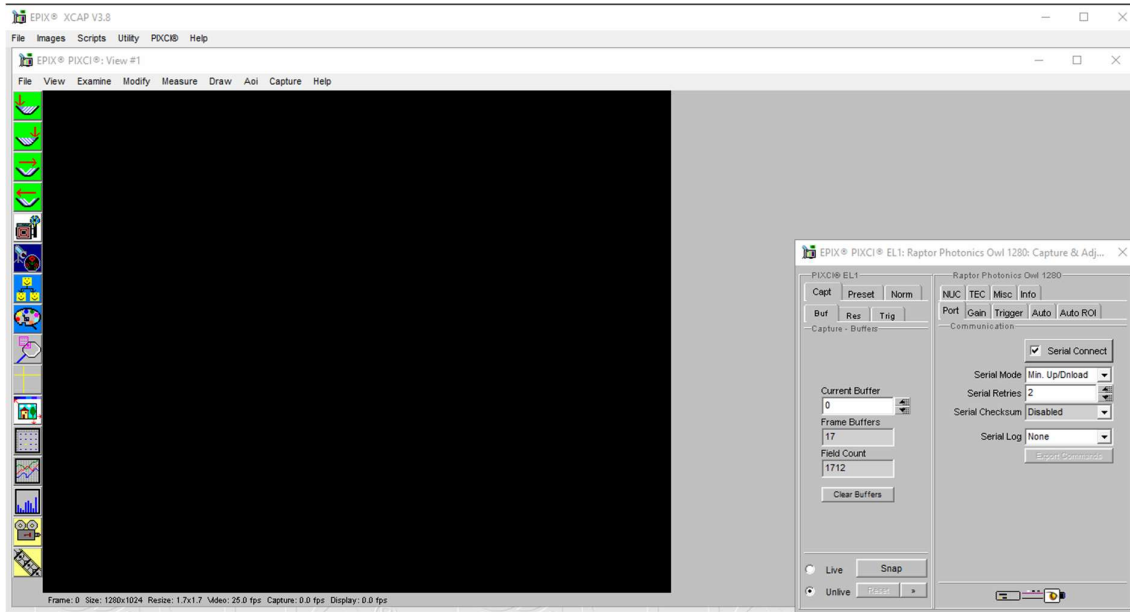

Figure 3: XCAP Camera Control Screen

6. The camera controls are pre-configured in EPIX.

7. The control window on the right should reflect your chosen camera. For example, for the Owl 1280, it should read - EPIX PIXCI EL8: Raptor Photonics OWL 1280. If not, you need to select a different camera.

8. Check that the camera is communicating, see animated icon (Figure 4) on bottom right of control screen.



Figure 4: Active Communication

9. You are now configured and connected, ready to acquire an image.

10. Check the Serial Connect box (to establish serial communication to the camera). This should contain a tick (as circled in Figure 5).

11. Check the live button (as circled in Figure 5).

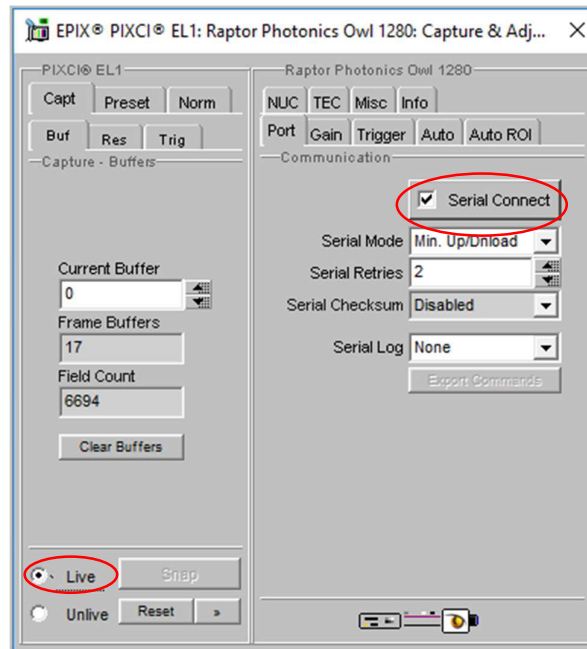

Figure 5: Image Capture

12. You should now see an image. On the bottom of the screen, you should see something similar to the following: *Frame: 0 Size: 1280x1024 Resize 1.7x1.7 Video: 25.0fps Capture: 25.0 fps Display: 25.0fps.*



Figure 6: Live Image Capture Window

### 4.3 Changing the settings on XCAP

You have the ability to change several settings to control the camera through the tabs in the control window of the EPIX software.

### 4.4 Exposure

Click on the Gain Tab.

There is an option for Auto Level Control (ALC). When Auto Level Control is unchecked, you can manually adjust the exposure and digital gain using the sliders or entering a specific value in the field. It is recommended to start with auto gain on to get an image, then turning it off to fine-tune your image.

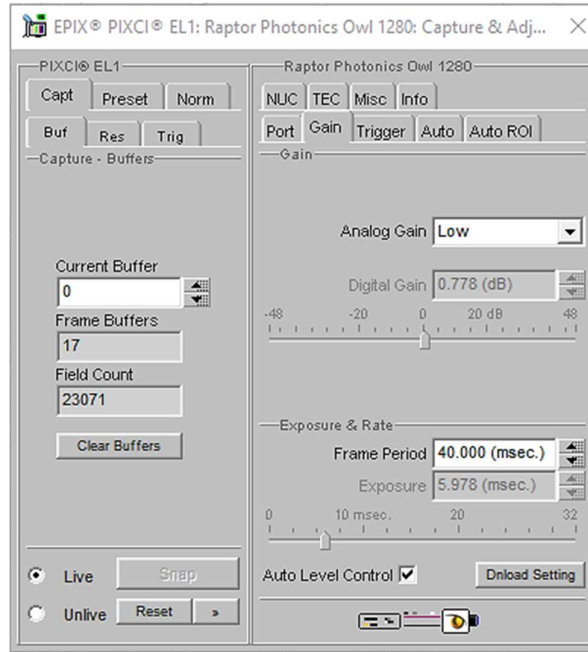

Figure 7: Gain Tab

## 4.5 Trigger

Use this tab to select the Readout Mode, and a Fixed Frame Rate value.

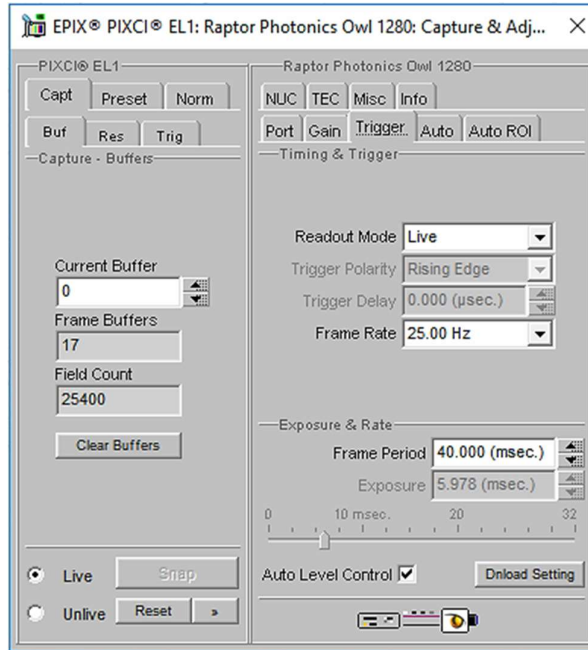

Figure 8: Trigger Tab

## 4.6 Auto

On this Tab, you can select the parameters for the Automatic Level Control, Including the speed, and spread of signal. In this mode, the FPGA of the camera will automatically adapt the exposure time and digital gain within the given frame rate to optimise the image quality.

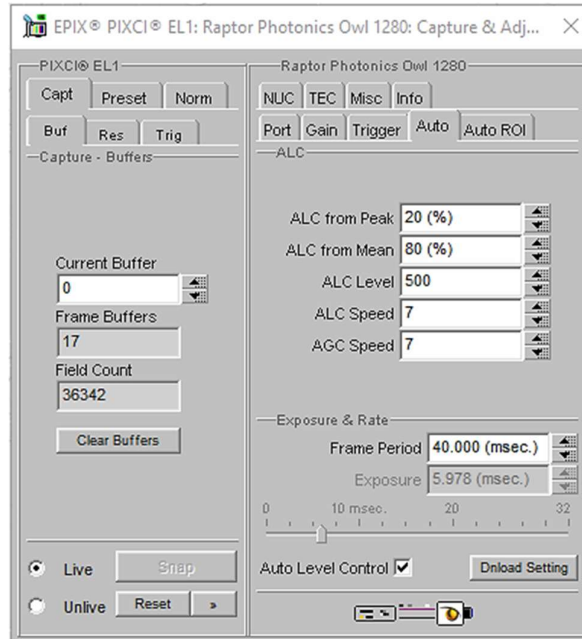

Figure 9: Auto Tab

## 4.7 Auto ROI

Use this tab to set the Region of Interest (ROI) used for the Auto Level Control; ROI gain will set an overlay onto the image, so you can track its position. By default, this will be set to account for the whole image. Edit the values of Offset, Width and Height to place the Auto Level Control ROI over the image.

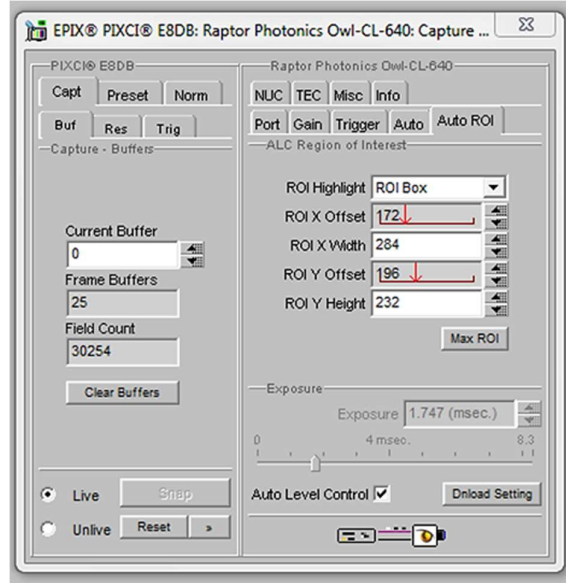

Figure 10: Auto ROI Tab

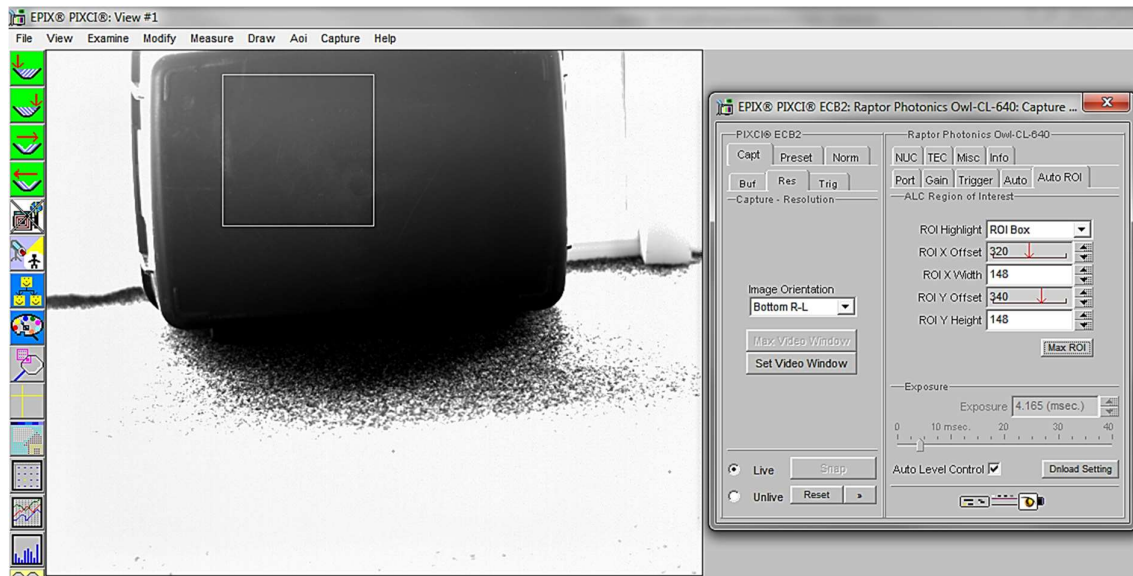

Figure 11: Active ROI Dark Area

In Figure 11, the ROI is contained within the small white box, and as such when centred on the black case we can see the minor scratches but the sun light on the carpet has saturated the image.

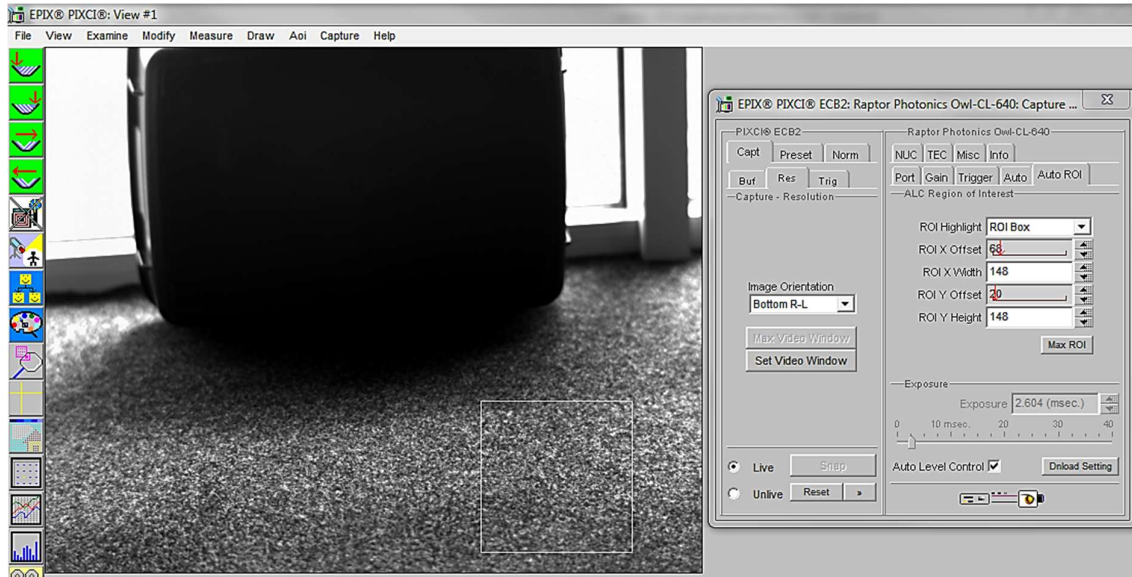

Figure 12: Active ROI

However, when we move the ROI box to the carpet, Figure 12, where the sun is shining the camera adjusts the exposure, but the box becomes too dark to see any detail. This is an extreme example used with our Owl 640 camera to illustrate this feature.



## 4.8 NUC

On this tab, you can select the parameters for the on-board Non Uniformity Correction (NUC); select the 3point NUC Offset, Gain & Dark shown in Figure 13. Figure 14 and Figure 15 show the effect of the NUC off and on. When Normal is selected the NUC will be off

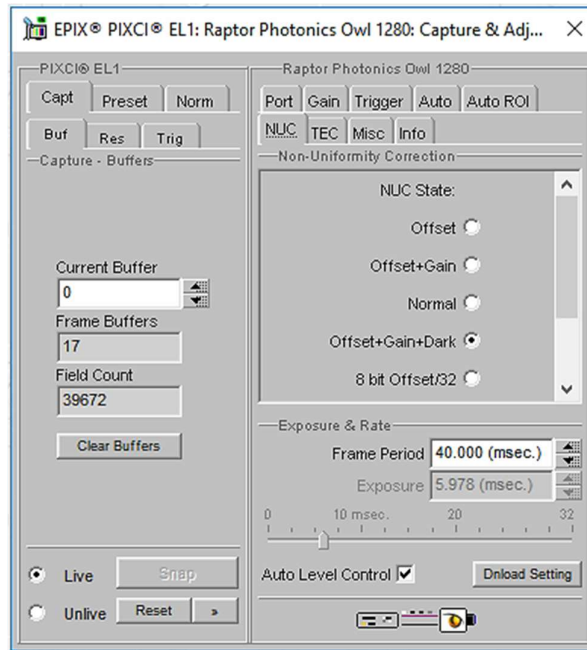

Figure 13: Controlling the NUC Status

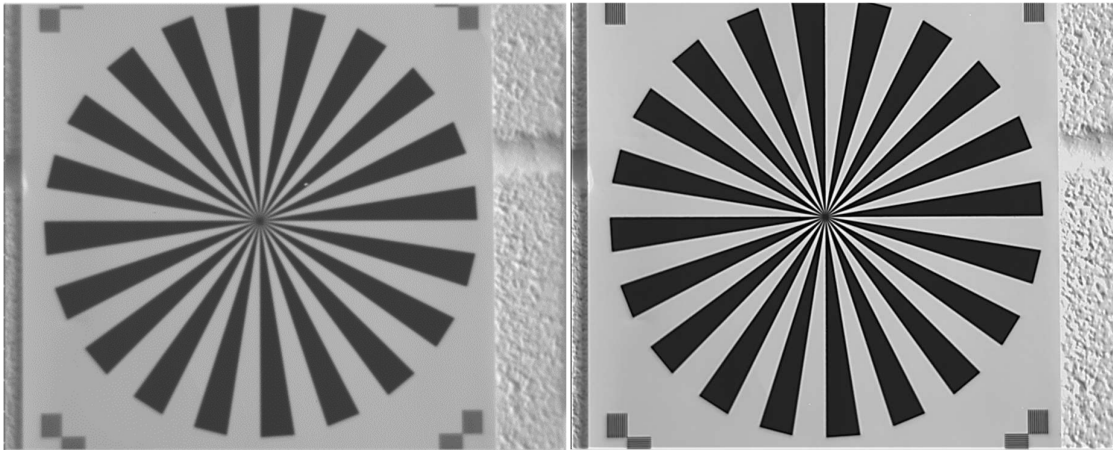

Figure 14: NUC Off

Figure 15: NUC On



## 4.9 TEC

Thermoelectric Cooling (TEC). Use this tab to set and read back the sensor temperature. The optimum temperature should be set on start-up, for the OWL 1280 should be 15°C.

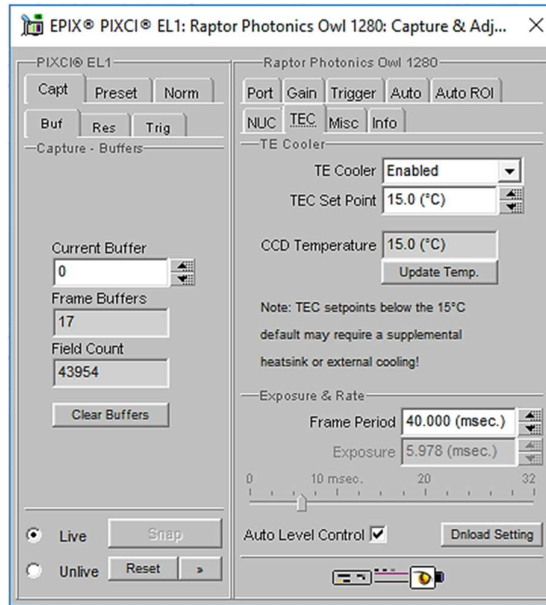

Figure 16: TEC Control

## 4.10 Miscellaneous

There are two features here, Video invert and Active Image Enhancement. Output video can be digitally inverted such that dark areas in the image will appear bright by checking the video invert box.

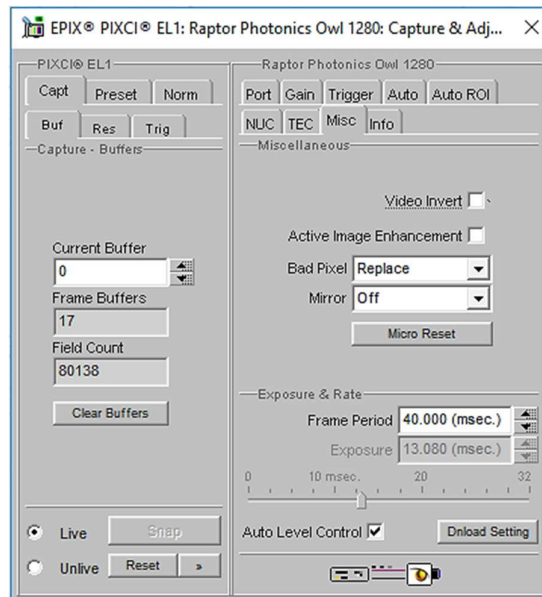

Figure 17: Camera Information

Output video can be digitally processed to provide image sharpening by checking the Active image enhancement box as shown in Figure 17.

The Info tab can be used to view the cameras manufacturer data, for example Build date and serial number.

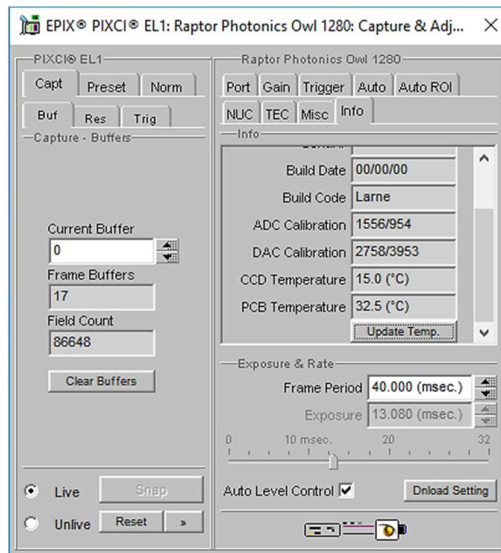

Figure 18: Information Tab

#### 4.11 Adjusting the image display (With XCAP Std only)

The Viewing Pallet is not automatically adjusted in the XCAP software.

This needs manually Configured to give the best display of the RAW image data from the camera.

1. Go to the Modify/Contrast Modification menu, Figure 19.
2. Select “Stretch Contrast, Histogram Percentile Endpoints” and “Preview” Figure 20: Stretch Contrast.
3. Adjust the “Low Percentile Endpoint” and “High Percentile Endpoint” to optimize the image display, defaults should be acceptable for most applications.

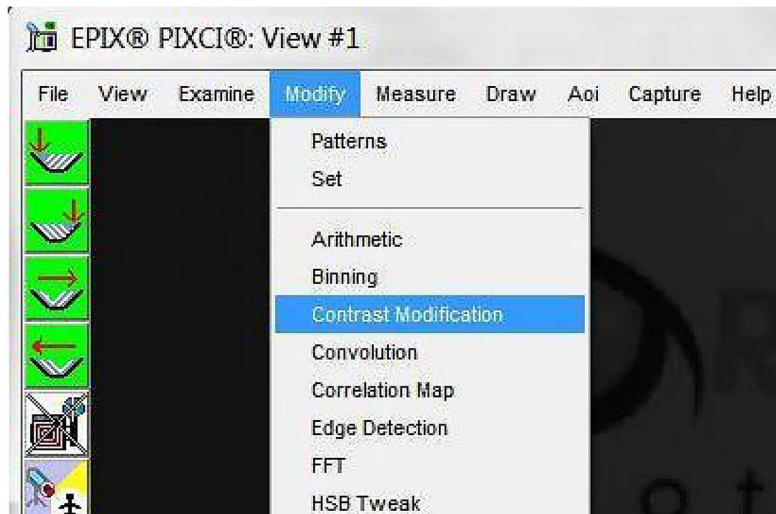

Figure 19: Contrast Modification

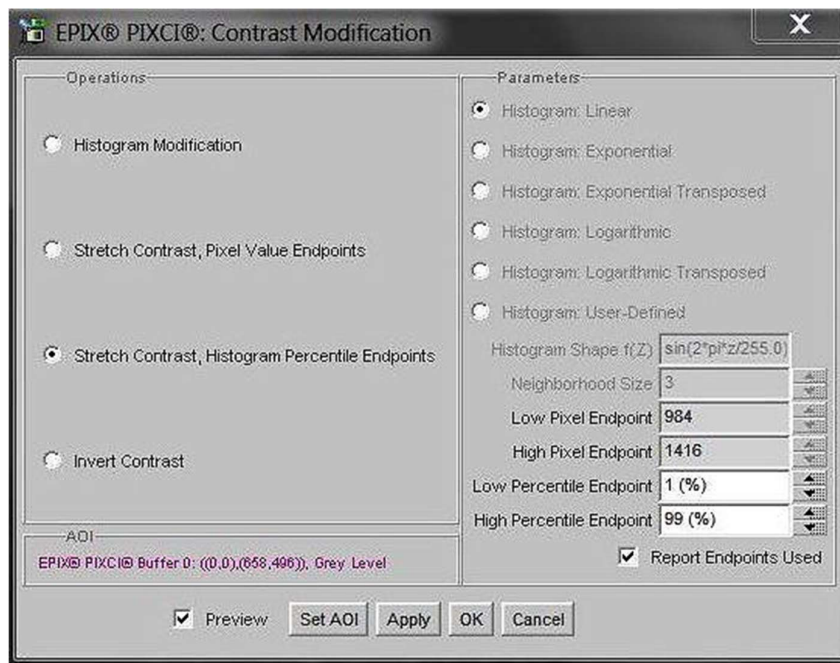

Figure 20: Stretch Contrast



**CORPORATE HEADQUARTERS**

Raptor Photonics LTD  
Willowbank Business Park  
Larne, Co Antrim  
BT40 2SF  
Northern Ireland  
PH: +44 2828 270141

[www.raptorphotonics.com](http://www.raptorphotonics.com)