

Owl 640 II

Model: OW1.7-VS-CL-640-II



USER MANUAL

CONTENTS

1. INTRODUCTION	4
1.1 Scope	4
2. CAMERA CARE	5
2.1 Cleaning the Sensor Window	5
3. SPECIFICATION	6
3.1 Camera Overview	6
3.2 Datasheet	6
4. DESIGN OVERVIEW	7
4.1 Mechanical Model	7
4.2 Physical Interface	8
4.3 Power Consumption	8
4.4 Mounting to a Microscope	8
4.5 Mounting to a Tripod or Optical Table	8
5. SOFTWARE COMPATIBILITY	9
5.1 XCAP Compatibility	9
5.2 Micro-Manager Compatibility	9
5.3 LabView Compatibility	9
5.4 Custom Software Interfacing	9
6. CAMERA SETUP AND REQUIRMENTS	10
6.1 Connecting the Camera to the Frame Grabber	10
6.2 Computer/Laptop System Requirements	10
6.3 Frame Grabber Requirements	10
6.4 CameraLink Cables	10
7. XCAP IMAGING SOFTWARE	11
7.1 Downloading XCAP	11
7.2 Opening the Camera Configuration	11
7.3 Acquiring a Live Image Sequence	13
8. CONTROLLING THE CAMERA (XCAP)	14
8.1 Exposure Time	14
8.2 Automatic Light Control Adjustment	16
8.2.1 Automatic Light Control Parameters	16
8.2.2 Automatic Light Control Region of Interest	17
8.2 Gain Mode	18
8.3 Trigger Mode and Frame Rate	19
8.4 Non-Uniformity Correction (NUC)	20

8.5 Thermoelectric Cooler (TEC)	21
8.6 Miscellaneous Tab.....	22
8.7 Manufacturers Data	23
9. XCAP CONTROL FEATURES	24
9.1 Recording Images on XCAP	24
9.2 Saving Preset Configuration Settings.....	24
9.3 Contrast Modification (XCAP Std. Only)	25
10. MICRO-MANAGER	26
10.1 Downloading and Installing Micro-Manager (Windows)	26
10.2 Creating Camera Configuration File.....	27
10.3 Pre-made Configuration File.....	31
10.4 Imaging and Controlling the Camera	32

1. INTRODUCTION

This document provides detailed instructions for the operation of the Owl 640 II camera. Raptor Photonics Limited reserves the right to change this document at any time without notice and disclaims liability for editorial, pictorial or typographical errors.

1.1 Scope

This manual covers the Owl 640 II digital camera and all applicable components. Details of the camera mechanical interface along with information on how to control the camera are stated. Each camera control is discussed and explained with the use of XCAP Imaging software, which is the core plug and play software package that is offered with Raptor cameras. Important precautions to be taken when using the camera are also stated.

An image of the camera is shown in Figure 1.



Figure 1: Complete Camera Module.

2. CAMERA CARE

2.1 Cleaning the Sensor Window

Raptor cameras require no regular maintenance except occasional external cleaning of the sensor window (the glass window between the camera sensor and the microscope or lens). Use optical grade isopropyl to clean this window. A cotton swab can be used, but may leave some fibres on the window, so be careful. To avoid this, you could also use a lens tissue or a cleaning swap such as a texwipe. Forced air can be applied to remove any loose particles. Should any other issues occur please contact your local agent.

CAUTION — The camera's sensor and circuits are sensitive to static discharge. Ensure that you are using a static strap or completely grounded at all times to release any static energy before you clean the window.

CAUTION — Do not use acetone.

3. SPECIFICATION

3.1 Camera Overview

The Owl 640 II is the next iteration of the highly successful Owl 640. With even smaller mechanics and the implementation of the smaller SDR Camera Link connector, the camera is even more compact and lightweight than before. The Owl 640 II is a rugged, high sensitivity digital VIS-SWIR camera. Using a 640 x 512 InGaAs sensor from SCD, the camera enables high sensitivity imaging from 0.4 μ m to 1.7 μ m.

The Camera Link digital interface provides the most stable platform for data transfer and the camera will work on any Camera Link standard frame grabber.

3.2 Datasheet

For the full specification of the Owl 640 II, the datasheet for the camera can be downloaded from the Raptor Photonics website using the link below:

<https://www.raptorphotonics.com/products/owl-640-ii/>

4. DESIGN OVERVIEW

4.1 Mechanical Model

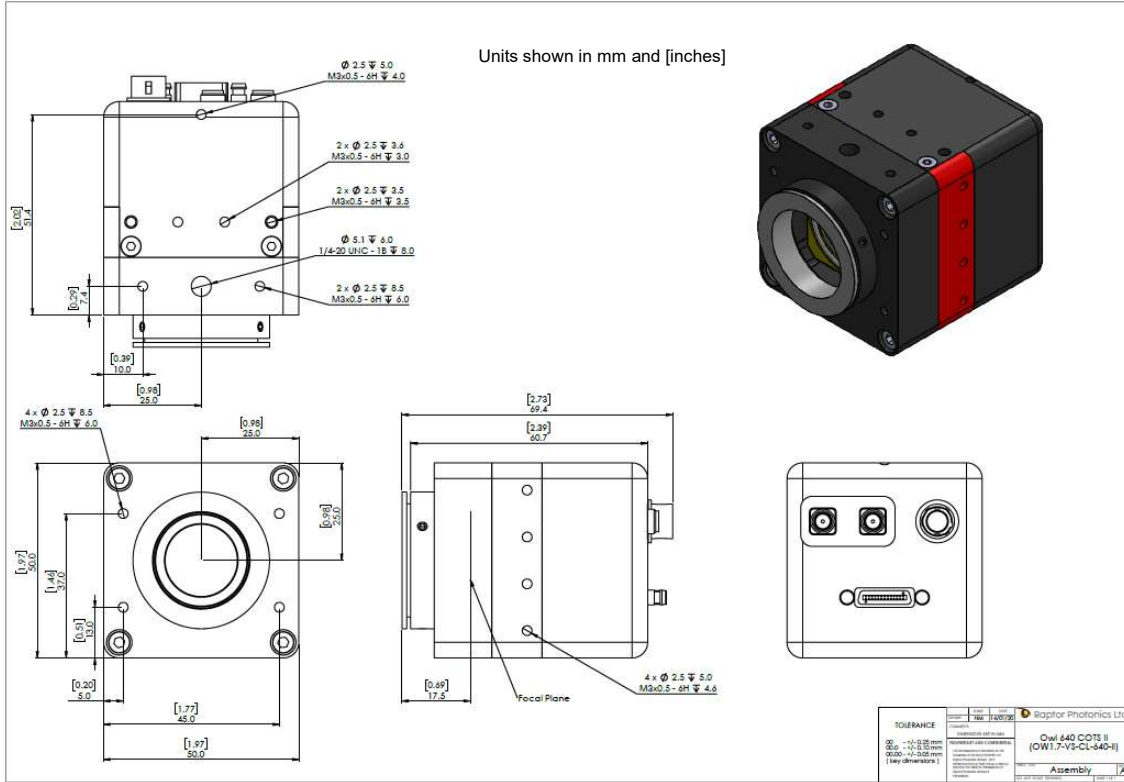

PDF of mechanical model available from our website:
<https://www.raptor Photonics.com/products/owl-640-ii/>

4.2 Physical Interface

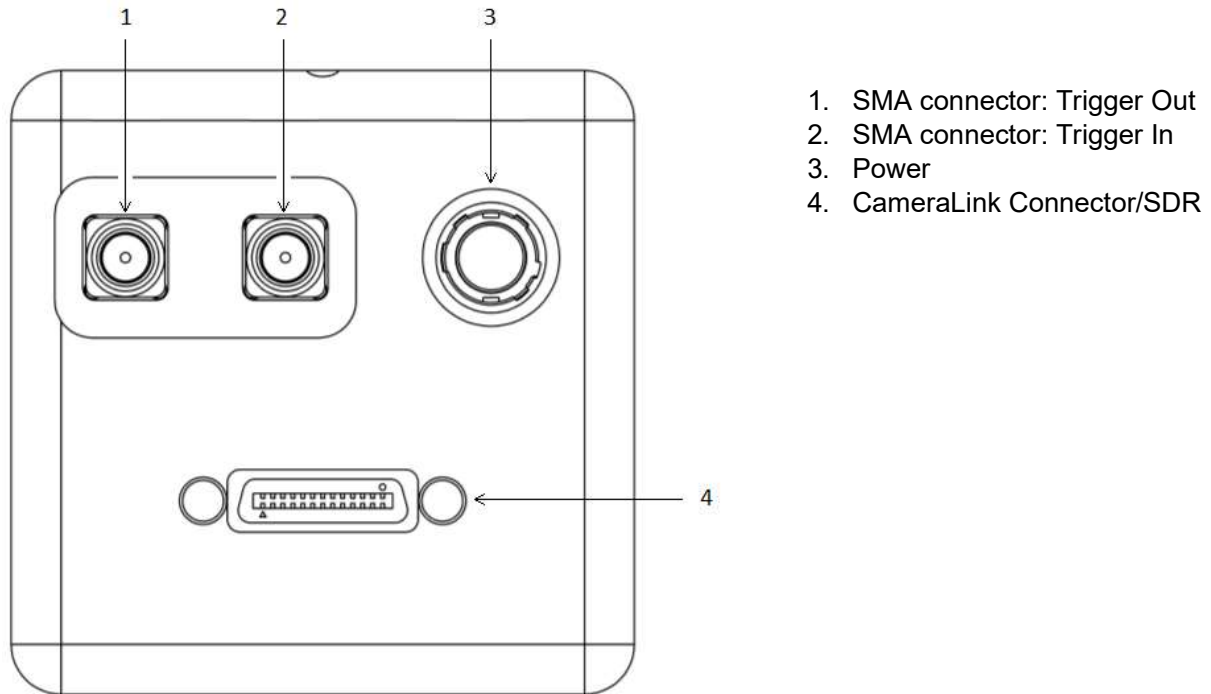

4.3 Power Consumption

Unit input power specification is +12V DC +/- 0.5V with <3W power dissipation when the TEC is disabled. An additional 5W may be required if the full drive to the TEC is required. This will be dependent on environmental conditions and the TEC temperature set point.

The set point for the TEC cooling is +15 °C. The TEC power is automatically adjusted to try and achieve the set point temperature, with a limit of approx. 5W drive. For low ambient temperatures or with additional heat sinking, less than 5W may be applied to the TEC to achieve the set point. In an ambient of 25°C with adequate heat sinking, less than 1W is typically required to maintain the +15°C set point.

On power up, the peak power due to inrush current will be less than 10 Watts.

4.4 Mounting to a Microscope

The camera has a standard C-mount that should easily screw onto any microscope port.

4.5 Mounting to a Tripod or Optical Table

The camera has a ¼-20 BSW (Whitworth) threaded hole to mount to a tripod or an optical table.

5. SOFTWARE COMPATIBILITY

This section outlines the options relating to software that are available for the Owl 640 II.

5.1 XCAP Compatibility

Raptor works closely with EPIX who integrate all Raptor camera models into their XCAP Imaging Software package. XCAP is the core plug and play software package that is offered with the Owl 640 II.

5.2 Micro-Manager Compatibility

The Owl 640 II can be controlled and imaged using the free open source software package, Micro-Manager. Using the camera with this software package is discussed in section 10.

5.3 LabView Compatibility

Raptor can supply a LabView .icd file which can be used to control the camera on National Instruments imaging tools such as NI MAX. The file may also be useful if attempting to create a custom LabView VI.

5.4 Custom Software Interfacing

Raptor works closely with EPIX Inc, who integrates all Raptor cameras into their software package, XCAP. The EPIX frame grabbers are the models that we offer with our cameras. We offer their Software Development Kit (SDK) for interfacing with custom software (XCLIB). If using a frame grabber from a different company, then you will have to obtain their SDK. Raptor can provide an ICD which includes a list of all serial commands to control the camera. This would be required along with the SDK from the frame grabber device to integrate the camera.

6. CAMERA SETUP AND REQUIREMENTS

This section will give instruction on connecting the frame grabber to the camera, as well as outlining important frame grabber and PC requirements.

6.1 Connecting the Camera to the Frame Grabber

The camera has the shrunk SDR port on the interface. The main frame grabber that Raptor offer with this camera has the normal MDR port (EPIX EB1). Therefore, one MDR – SDR Camera Link cable is required to connect the camera to this frame grabber.

If demoing the camera with the Mini PC system that Raptor provides, you should connect to the left port of the frame grabber in the Mini PC. This should be stated on the Mini PC.

6.2 Computer/Laptop System Requirements

The basic system requirement is that the PCIe bus of the system must provide sufficient bandwidth to handle video rate transfers. The amount of bandwidth required depends on the camera in-hand. The Owl 640 II uses a Base Camera Link interface which can be handled with a x1 PCIe bus and PIXCI EB1 from EPIX, providing roughly 200MB/sec maximum bandwidth. Contact EPIX Inc. for further information regarding minimum computer/laptop specification requirements to run the XCAP Imaging Software.

6.3 Frame Grabber Requirements

If using a computer, it is a minimum requirement to use an PIXCI EB1 frame grabber. If using a frame grabber from another company, the specification requirements of this frame grabber must meet those supplied by the PIXCI EB1 model.

If using a laptop, EPIX offers base Camera Link frame grabbers for a laptop system, such as the ECB1/ECB1-34.

6.4 CameraLink Cables

If using a CameraLink cable not supplied direct from Raptor, for CE compliance we recommend using a screened CameraLink cable with ferrite (100 ohms at 100MHz) fitted as close to the camera as possible.

7. XCAP IMAGING SOFTWARE

This section will discuss downloading and acquiring an image using XCAP.

7.1 Downloading XCAP

The latest version of XCAP can be downloaded from the link below:

<http://www.epixinc.com/support/files.php>

Please select the appropriate version of XCAP for your computer. Ensure that you download from the section labelled “**Pre-release version with support for the latest cameras and latest PIXCI® imaging boards**”. Open the downloaded file when complete and follow the onscreen instructions in the installation wizard. If a pop-up message appears asking whether to install the PIXCI driver, ensure that you click yes.

7.2 Opening the Camera Configuration

After opening XCAP, select “PIXCI Open/Close” from the “PIXCI” tab from the top menu bar in the main window. A PIXCI Open/Close pop-up box will open as shown in Figure 2.

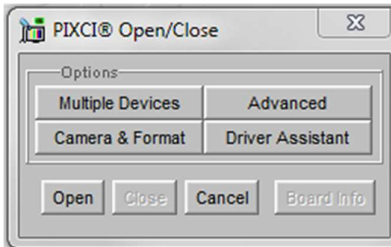

Figure 2: PIXCI Open/Close.

Click on “Camera & Format” that is highlighted in Figure 2 and a “PIXCI Open Camera & Format” box will appear, as shown in Figure 3.

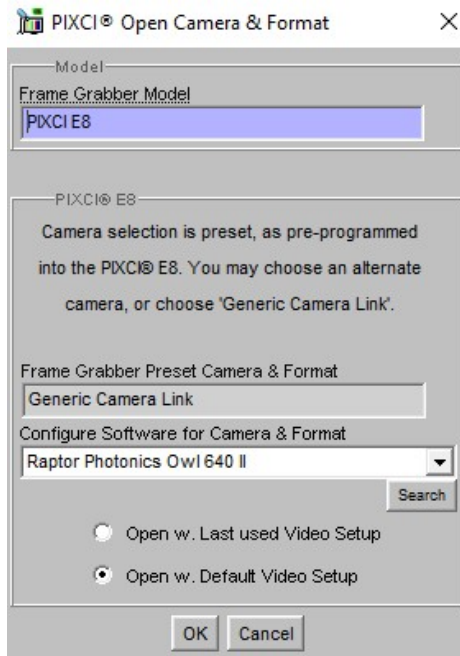

Figure 3: PIXCI Open Camera & Format.

Using the dropdown menu highlighted, search for “Owl 640 II”. You will see the configuration for “Raptor Photonics Owl 640 II”. Selecting “Open w. Default Video Setup” will open the control panel with all control parameters set to the default states. “Open w. Last used Video Setup” will open the control panel with all parameters set at the last known state. Once this option between the two has been selected, click “Ok”. To open the camera control panel and imaging window, click “Open” in the “PIXCI Open/Close” window (Figure 2).

Two windows will now open in XCAP, an imaging window and control panel, as shown in Figure 4.

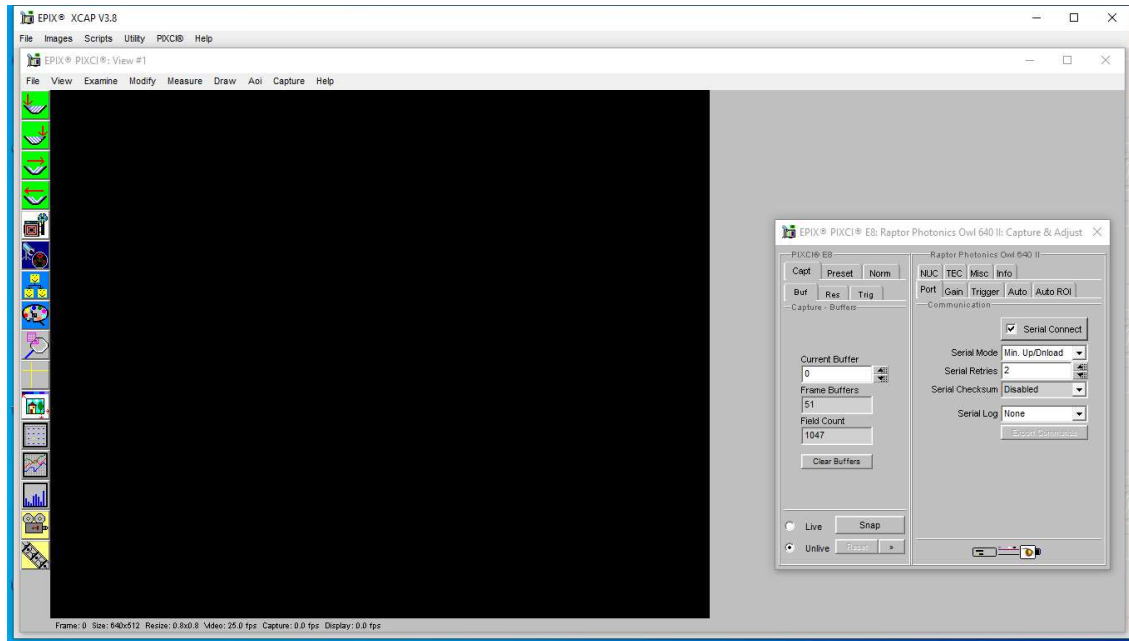

Figure 4: Imaging Window and Control Panel.

7.3 Acquiring a Live Image Sequence

There are two things to observe in the control panel that inform you that the camera is connected and ready to image.

The serial connect checkbox must be ticked in the control panel. This informs you that you have established a serial connection with the camera and can control the camera.

Secondly, the symbol near the bottom right of the control panel will have three moving dots. This indicates that you are obtaining video data from the camera. The imaging statistics displayed directly underneath the imaging window will also inform you if you are receiving a video feed from the camera.

Once you have established a serial connection with the camera and are receiving video data, you can now grab a live image feed. Clicking the “Live” button will grab a live image sequence which you will now see in the imaging window.

The symbols in the control app discussed above are displayed in Figure 5.

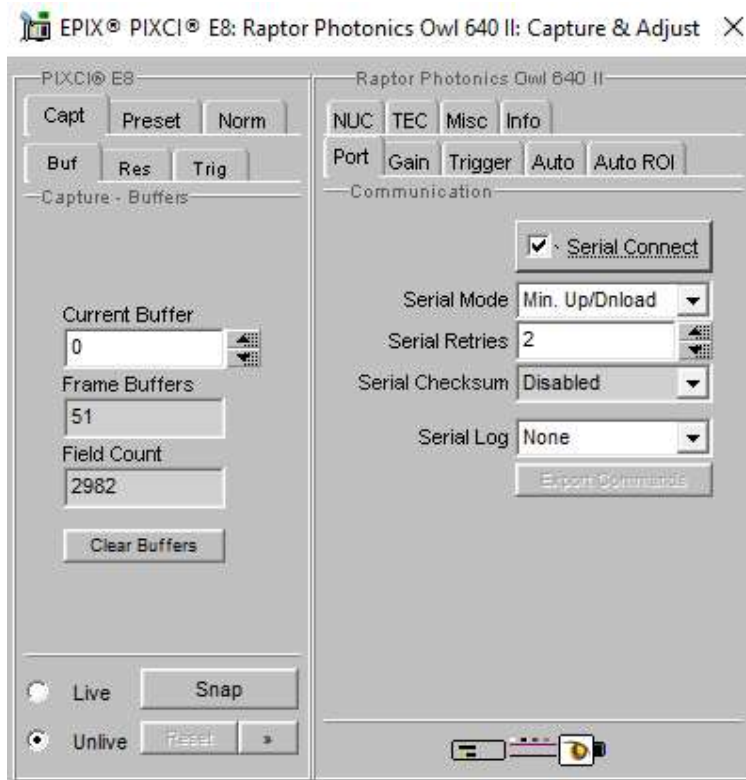

Figure 5: Checking Camera Connection and Acquiring a Live Image.

8. CONTROLLING THE CAMERA (XCAP)

The sections below will give information on using each control of the Owl 640 II, giving a description on how to use each control parameter and their effect on the camera's performance. The software used to illustrate the camera controls is XCAP.

8.1 Exposure Time

The exposure time can be controlled under any camera control tab in the XCAP GUI and remains constant on the GUI.

Exposure Time: By default, the auto exposure control (ALC) will be enabled, meaning that the exposure time and digital gain cannot be manually selected. The ALC will automatically adjust these parameters based on the signal strength. The ALC can be fine-tuned in multiple ways. These controls are discussed in section 8.2.

If the ALC is disabled, the user will be able to set a fixed exposure time and digital gain, using either the manual input box or the slider bar. The maximum exposure time that the camera can perform in theory is ~26.8s. However in practice, with the sensor only stabilised at +15°C, the image would display a lot of dark noise with large exposure times. This camera is not designed for large exposure times and is made for applications using video frame rates e.g. 25Hz. The maximum exposure time possible is discussed further in this section. An exposure time can be set either using the user input box or the slider.

The minimum and maximum exposure times that the camera can set are shown in the table below in Figure 6.

	High Gain	Low Gain
Min. Exposure Time	100µs	1µs
Max. Exposure Time	Frame Period – Readout Time	Frame Period – Readout Time

Figure 6: Minimum and Maximum Exposure Times.

Frame Rate and Maximum Exposure Time Relationship: The maximum exposure time is a function of the frame period (1/frame rate) and the readout time. The relationship between these three parameters is shown below:

$$\text{Maximum Exposure Time} = \text{Frame Period} - \text{Readout Time}$$

The readout time for the Owl 640 II is dependent on whether the camera is in low (LG) or high (HG) gain. The readout times for each gain mode are as follows:

Readout Time (LG) = ~6ms
Readout Time (HG) = ~10ms

When using an example of a frame rate of 25fps in low gain, the maximum exposure time possible at this frame rate would be:

$$\begin{aligned}\text{Maximum Exposure Time} &= \left(\frac{1}{25}\right) - (6 \times 10^{-3}) \\ &= 34ms\end{aligned}$$

The exposure time controls on XCAP are shown in Figure 7.

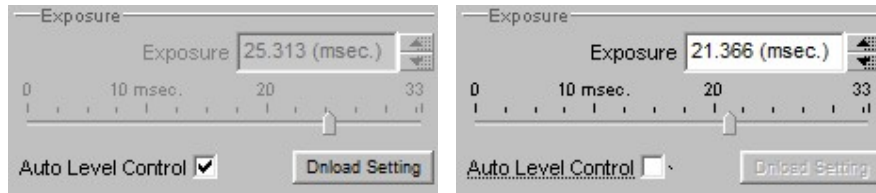

Figure 7: ALC and Manual Exposure Time Controls.

8.2 Automatic Light Control Adjustment

The ALC can be fine-tuned by adjusting a few different parameters. A Region of Interest (ROI) of pixels can also be defined in which to drive the ALC. These controls are discussed below.

8.2.1 Automatic Light Control Parameters

Peak and average video levels are derived and monitored for the active ROI and are used to drive the ALC. The active video level used to compare to the set point can be adjusted from full average to full peak or a percentage of both. The percentage used of the average and peak video levels can be adjusted from the “Auto” tab in the XCAP GUI. An explanation of the average and peak video levels is stated below.

Average Video Level: An average video level is calculated for the active ROI. This value will be calculated in real time, i.e. as pixel data in the ROI is captured from the sensor, it is fed directly to an accumulator. At the end of the frame, the accumulator is divided to give a true average.

Peak Video Level: The peak video is determined from a rolling average of 4 pixels. Current pixel + 3 previous pixels are used to derive a peak value. This peak value is monitored for the ROI and latched at the end of frame.

Selecting a greater percentage from the average will drive the ALC to use greater exposure and digital gain values. Selecting a greater percentage from the peak will have the opposite effect.

ALC Level: The ALC level can also be adjusted to fine tune the ALC. Increasing the level will cause greater exposure and digital gain values to be set by the ALC. Decreasing the level will have the opposite effect.

Both controls can be adjusted to optimise the ALC for the current imaging scene conditions.

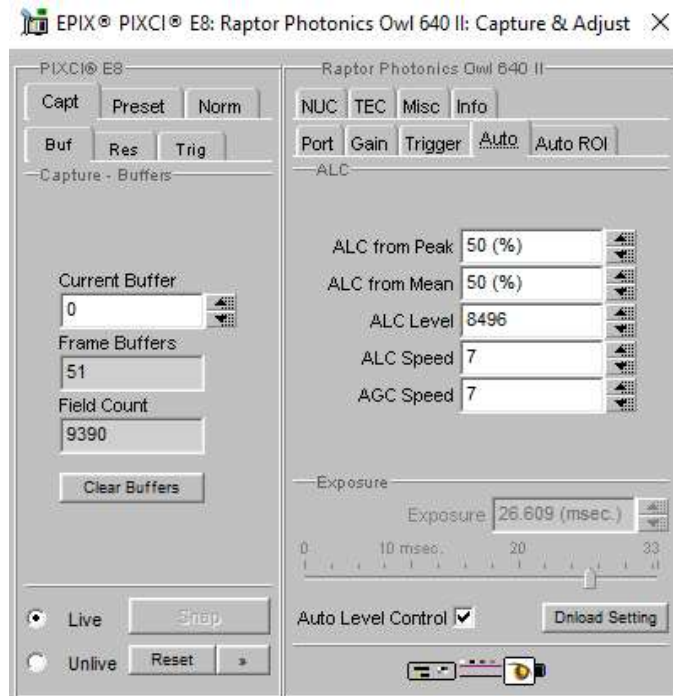

Figure 8: ALC Parameters.

8.2.2 Automatic Light Control Region of Interest

A Region of Interest (ROI) within the main active region of 640 x 512 may be defined. This region is used to calculate peak and average video levels to drive the Automatic Light Control (ALC) function of the camera (discussed in section 8.3.1).

The ROI offset and sizes are outlined in Figure 9.

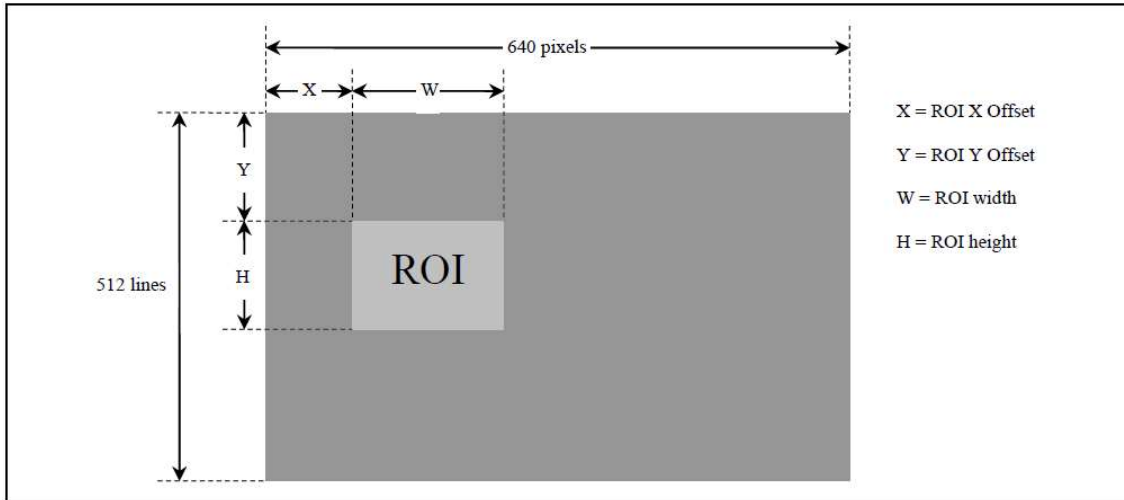

Figure 9: Region of Interest Size and Offset.

The active ROI for the ALC can be adjusted from the “Auto ROI” tab in the XCAP GUI, shown in Figure 10.

The ROI can be moved to within a resolution of 4 pixels in the X and Y, and the ROI size will have a resolution of 4 pixels.

An optional ROI outline feature can be enabled that highlights a 1 pixel wide box around the active ROI set. This can be enabled by selecting “ROI Box” from the “ROI Highlight” dropdown box. If the ROI highlight box is enabled or disabled, all pixels will have a gain of 1x.

If “ROI Contrast” is enabled, all pixels outside of the ROI selected will have a gain of 0.75x.

8.2 Gain Mode

The camera has two modes of operation, high gain mode and low gain mode (default). The gain mode of the camera can be toggled from the “Gain” tab on the GUI. If the ALC is enabled, the gain mode will be controlled automatically depending on the imaging scene illumination.

High gain mode provides the best noise performance and can provide better images for low scene illumination e.g. night imaging.

Low gain mode provides the best dynamic range and can provide better images for high scene illumination e.g. daytime imaging or using large exposure times.

The gain mode control is shown in Figure 10.

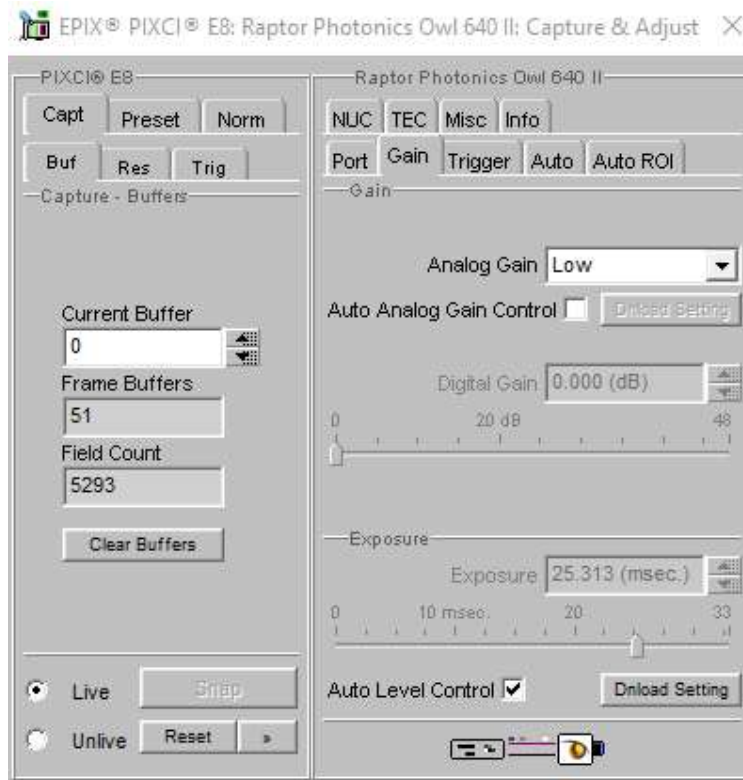

Figure 10: Gain Mode Control.

8.3 Trigger Mode and Frame Rate

Trigger Mode: The trigger mode of the camera and additional trigger controls can be controlled from the “*Trigger*” tab in the GUI, shown in Figure 11.

The trigger mode of the camera can be toggled from the “*Readout Mode*” dropdown box. By default, the camera will be set to internal trigger, integrate then read (ITR). This mode is indicated by the “*Live*” option in the dropdown box.

The camera can be switched to external trigger mode by selecting the “*Ext. Triggered*” option. When this mode is enabled, the “*Trigger Polarity*” (rising or falling edge) dropdown input box will become available. By default, the camera will run with a rising edge trigger polarity. A trigger delay can also be set when external trigger mode is enabled.

Frame Rate: The XCAP GUI gives the user multiple discrete frame rate options to select from, ranging from 25Hz to 120Hz. The frame rate can be selected from the “*Frame Rate*” dropdown box on XCAP. Note that due to the higher readout time in high gain, the maximum frame rate is smaller in high gain at 90Hz.

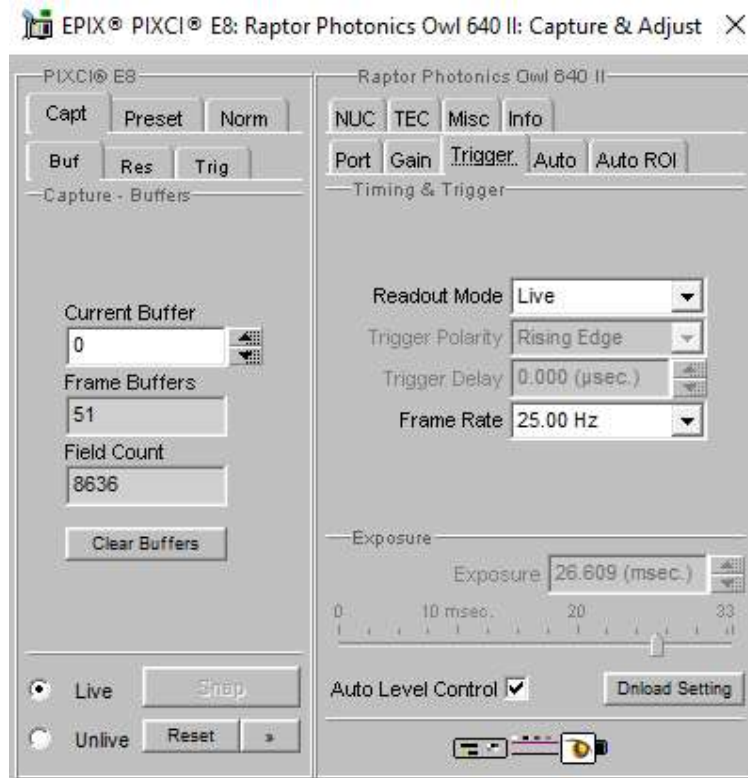

Figure 11: Trigger Mode and Frame Rate.

8.4 Non-Uniformity Correction (NUC)

The NUC state of the camera can be controlled from the “NUC” tab of the GUI. The camera has a 3 point (offset, gain, dark) NUC performed live on board the FPGA of the camera, correcting for fixed pattern noise. There is also a bad pixel correction when the 3 point NUC is active.

By default, the 3 point NUC and bad pixel correction will be enabled (3 Point NUC On – Offset+Gain+Dark). If wanting to output the raw data from the camera, the 3 point NUC can be disabled (3 Point NUC Off – Raw Data).

The NUC controls are shown in Figure 12.

Bad Pixels: Regarding bad pixels, our Short Wavelength Infra-Red (SWIR) cameras use an InGaAs Focal-Plane Array (FPA) sensor which consists of an InGaAs layer bonded to a CMOS read out integrated circuit (ROIC) by indium dots. This architecture makes it extremely difficult to manufacture a sensor where all the pixels are fully functional. Issues between the InGaAs layer, indium dots and CMOS ROIC are inevitable. Therefore, all Raptor SWIR cameras have a pixel operability specification, describing how many pixels are operating within normal parameters. Raptor uses the best quality sensors available on the market achieving up to 99.5% pixel operability at delivery. The remaining 0.5% pixels can be dead, hot or simply vary too much from the average. These must be compensated for to achieve the best image quality. These bad pixels are corrected for in our NUC.

Bad pixels appearing over time is normal and unfortunately an inevitable aging process. To correct for new bad pixels that have appeared over time, the bad pixel correction map on the camera FPGA would need updated. This means that the camera would have to be returned to Raptor to re-NUC the camera to update the bad pixel correction map. This is something that would not be possible to do if wanting to send the camera back for every new bad pixel. Raptor use the highest quality InGaAs sensors available on the market, however.

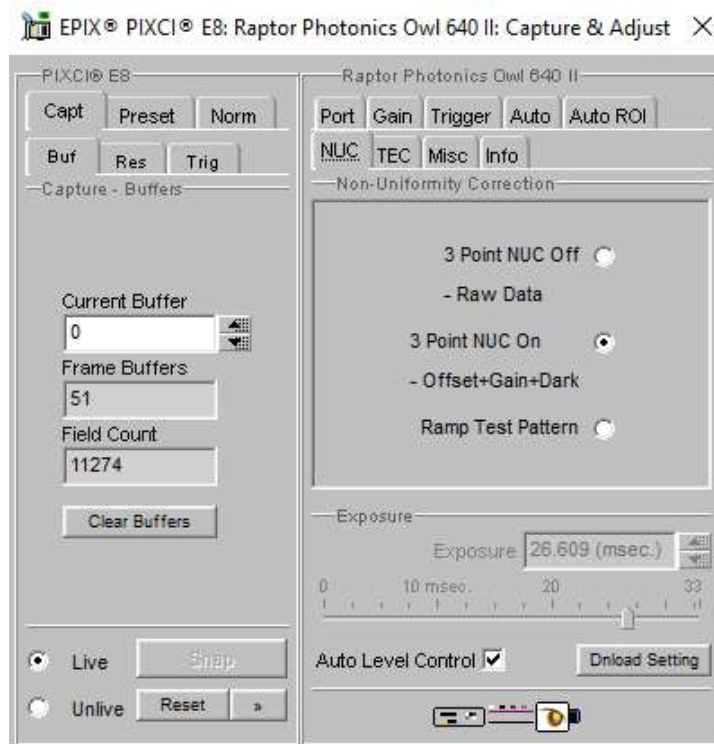

Figure 12: 3 Point NUC Control.

8.5 Thermoelectric Cooler (TEC)

The Owl 640 II uses a TEC to stabilise the sensor temperature at 15°C. The TEC status is shown in the “TEC” tab of the XCAP GUI, shown in Figure 13.

The TEC control can be enabled/disabled from this tab. By default, the TEC will be enabled and set to a 15°C set point. Raptor recommends keeping the set point at this temperature, as the camera is tested at this temperature under QC, and this is the specification TEC set point of the camera. The NUC is also performed at this temperature also so will not be optimal at other sensor temperatures.

There is roughly a 35-40°C delta between the PCB and sensor temperature so the set point can possibly be set slightly lower than 15°C if imaging in very low ambient temperatures with adequate heat sinking of the camera. As previously mentioned however, the NUC is not optimised at sensor temperatures outside of 15°C and the camera is not tested at sensor temperatures under 15°C. This is outside the specification of the camera.

The sensor temperature can also be read back from this tab. Clicking “Update Temp.” will read the current sensor temperature.

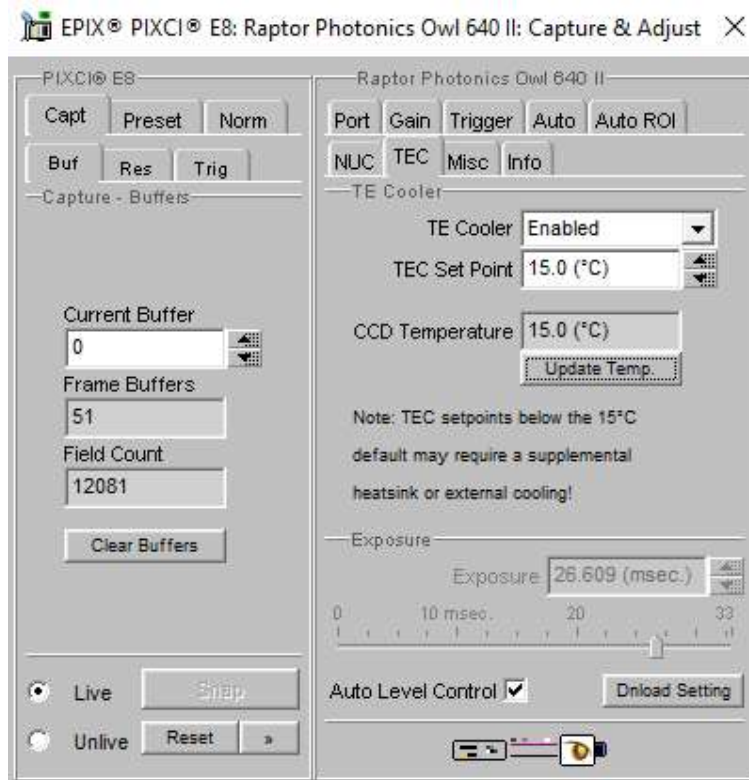

Figure 13: Thermoelectric Cooler (TEC) Control.

8.6 Miscellaneous Tab

The miscellaneous tab displays some minor controls for the camera, explained below:

Video Invert: Inverts the video pixel values

Active Image Enhancement: Sharpens Image

Bad Pixel: Selecting “*Highlight*” will show the bad pixel map on the image that the NUC is correcting for. Selecting the default “*Replace*” will hide the bad pixel map.

Mirror: Selecting “*Horizontal*” will flip the image horizontally in the y-axis.

By default, all of these controls will be disabled, except for the horizontal flip. This is shown in Figure 14.

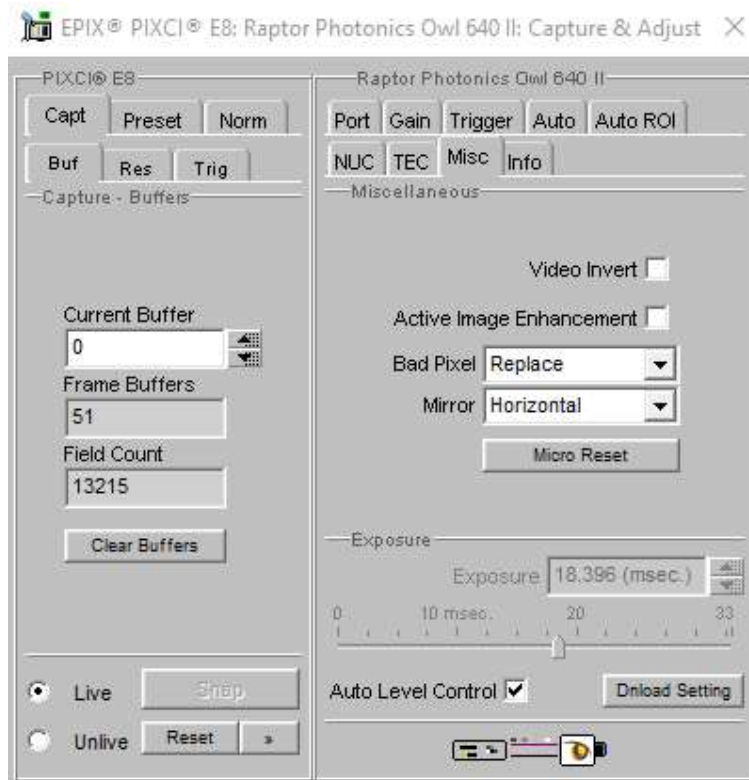

Figure 14: Miscellaneous Tab.

8.7 Manufacturers Data

The “Info” tab displays the manufacturers data of the camera, such as the firmware version and serial number etc. The PCB and sensor temperature can be read back from this tab by clicking “Update Temp.” The “Info” tab is shown in Figure 15.

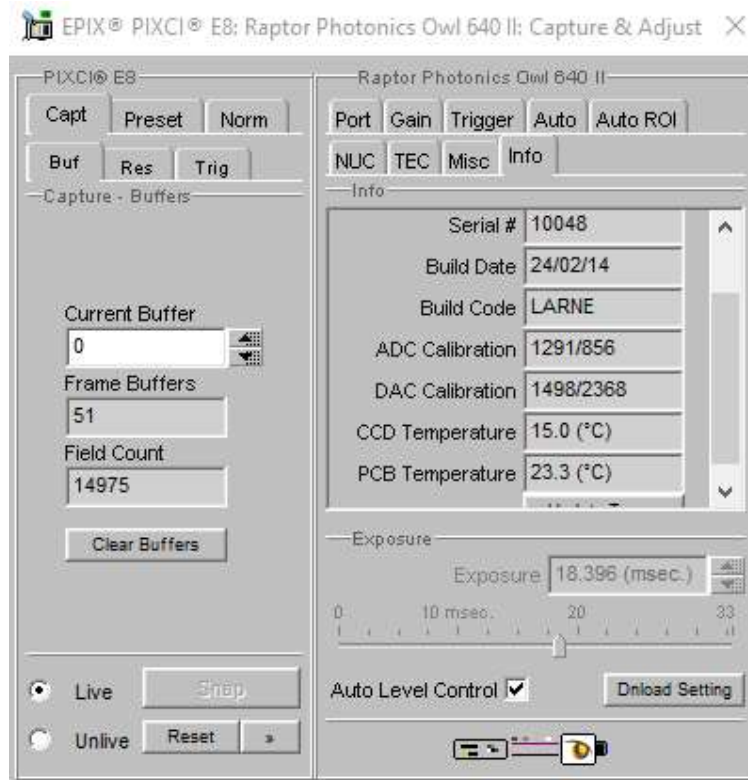

Figure 15: Manufacturers Data.

9. XCAP CONTROL FEATURES

XCAP has many different control functions and analytical tools that can be used when imaging the camera. For the full XCAP user guide, please refer to the link below:

http://epixinc.com/manuals/pixci_e14el/index.htm

This section will discuss in detail a few features on XCAP that Raptor thinks would be of immediate use when using the camera.

9.1 Recording Images on XCAP

Capturing an image sequence is outlined in the full XCAP user manual (link in section 10). Raptor also has a separate user manual which covers recording images on XCAP. Please contact Raptor to obtain this manual.

9.2 Saving Preset Configuration Settings

Different camera and frame grabber settings can be saved in the “Preset” tab under the “PIXCI *Frame Grabber Model*” section of the GUI, as shown in Figure 16.

Up to three different presets can be saved per settings file. If the camera is set to a desired state outside of the default parameters, clicking “Save 1” will save all the current parameter states that have been set. This can be done a further two times. These camera states can be recalled at any time by using the recall buttons. The overall settings file can then be saved and loaded in this tab also. Three preset states are the maximum number that can be saved in a settings file.

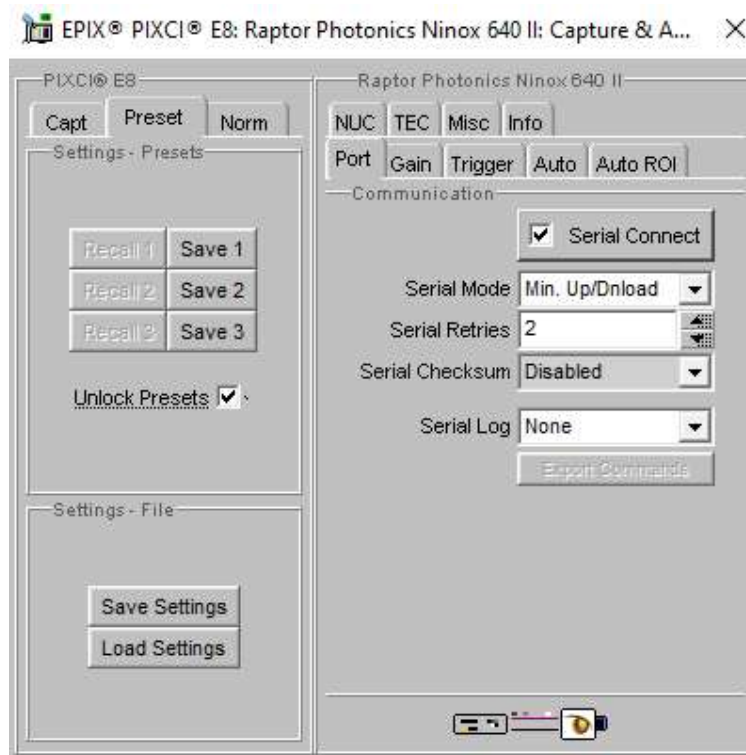

Figure 16: Preset Configuration Settings.

9.3 Contrast Modification (XCAP Std. Only)

The image contrast can be modified from the “*Contrast Modification*” section under the “*Modify*” tab in the XCAP imaging window. The location of this control feature is shown in Figure 17.

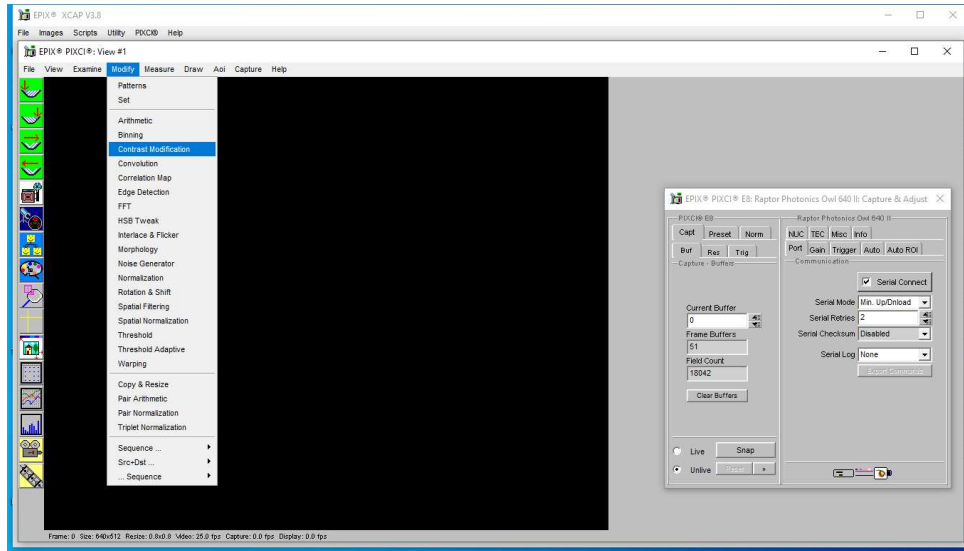

Figure 17: Contrast Modification Location on Toolbar.

In the contrast modification box, that can be seen from Figure 18, select “*Stretch Contrast, Histogram Percentile Endpoints*” and click “*preview*”. The contrast modification will now be applied over the live image feed. The contrast can be adjusted using the low and high end percentile point controls. The default settings are usually adequate for most applications.

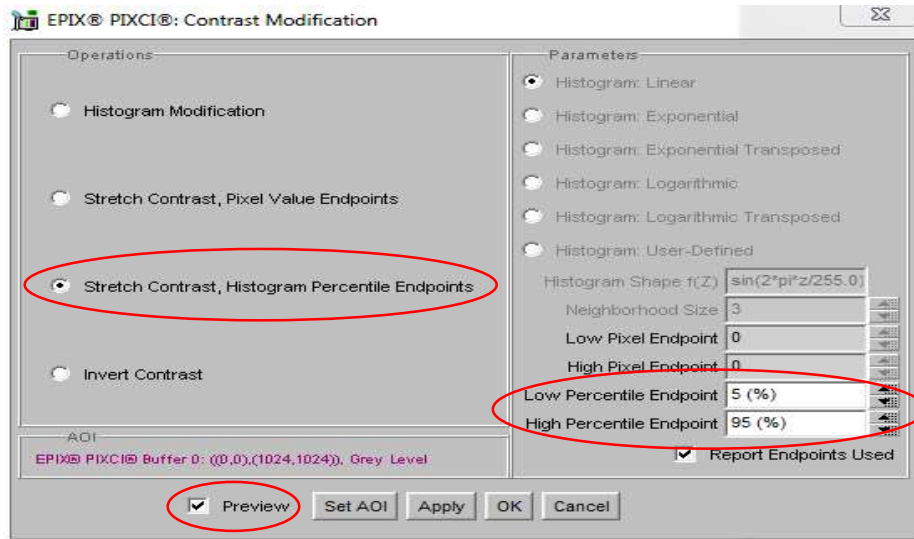

Figure 18: Contrast Modification.

10. MICRO-MANAGER

Micro-Manager is a free open source software package that enables you to image and control the Owl 640 II. Primarily, it is a software package designed for microscopy applications, as the software provides control of microscopes as well as the camera. However, Micro-Manager can also be used to simply image the Owl 640 II and control each of its parameters.

Micro-Manager is a complete image acquisition and camera & microscope control package, available for Windows. The software package is also available for Mac. However, using the Falcon III with a Mac would most likely be problematic due to the lack of PCIe slot for the frame grabber. Linux can also be used, but there is no precompiled Micro-Manager version available. Windows is the easiest and most common solution to use. Micro-Manager is easy to install and configure and offers a plug and play solution for using the Falcon III. It's also a software framework for implementing advanced and novel imaging procedures, extending functionality, customization and rapid development of specialized imaging applications.

Micro-Manager has been developed at UCSF since the beginning of the project. Starting on October 1, 2015, Micro-Manager is developed and maintained by Open Imaging, a company founded by the Micro-Manager development team.

10.1 Downloading and Installing Micro-Manager (Windows)

Micro-Manager is updated nightly. Raptor recommends downloading the latest nightly build from the link below:

https://micro-manager.org/wiki/Micro-Manager_Nightly_Builds

Select “*Version 1.4 Windows*” under “*Nightly Builds*” and download the latest 64 or 32 bit build, depending on the operating system being used.

After downloading and opening the setup application file, an installation wizard will appear. Micro-Manager will automatically be installed in “*C:\Program Files\Micro-Manager-1.4*”. If wanting to store Micro-Manager in another location, you can do this on the second page of the installation wizard. If not, you can simply keep selecting “*Next*” until the “*Install*” option is available on the last page of the installation wizard.

10.2 Creating Camera Configuration File

After loading up Micro-Manager, the start-up configuration window will pop up as seen from Figure 19. The user should ensure that “(none)” or “MMConfig_demo.cfg” is selected from the dropdown list and click “Ok”.

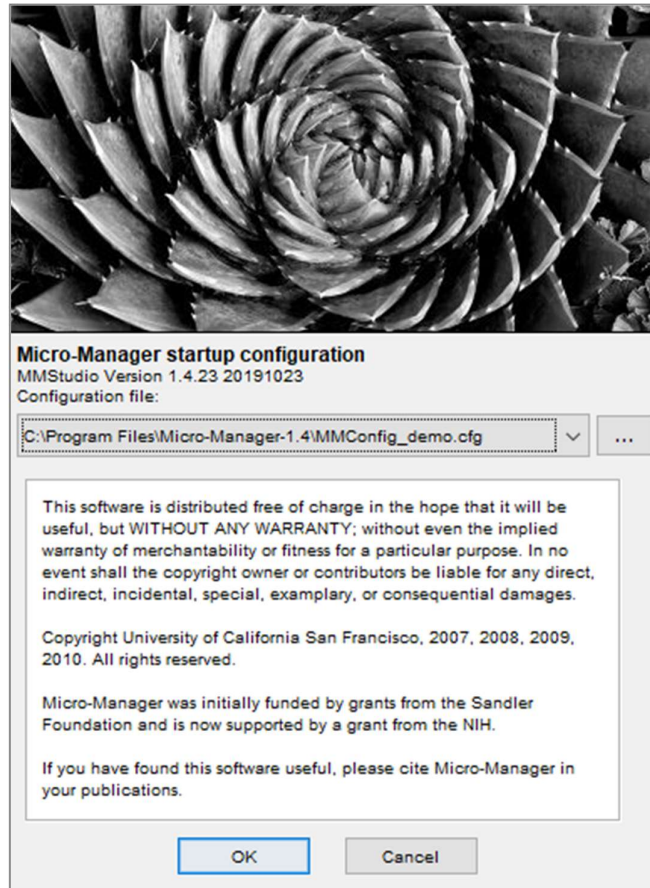

Figure 19: Start-up Configuration – Demo.

The main Micro-Manager window will now appear. To access the hardware configuration wizard to create the configuration file, go to the tools tab on the toolbar, shown in Figure 20.

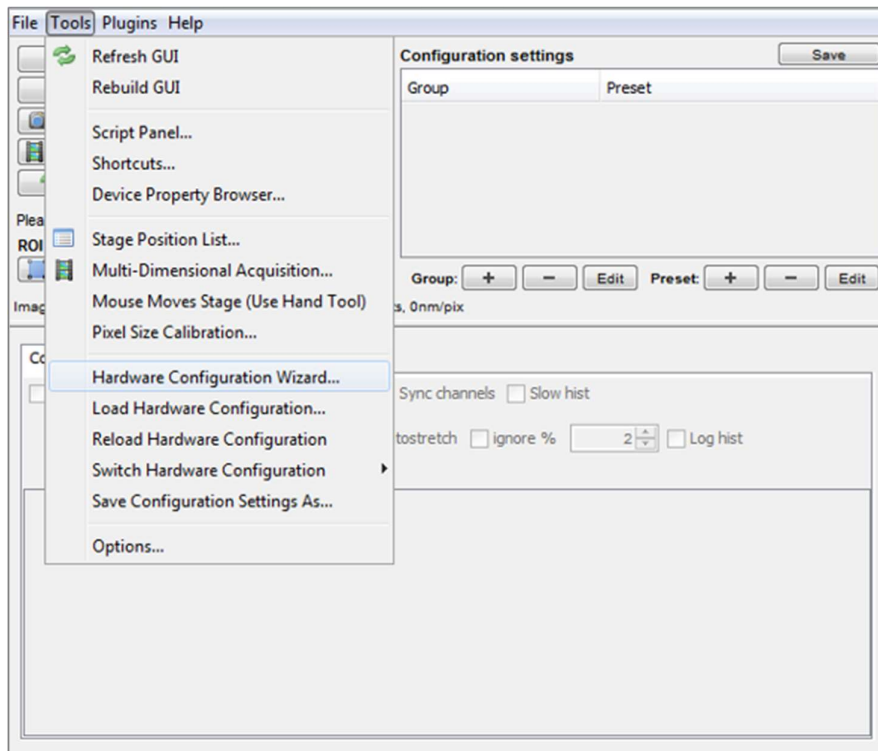

Figure 20: Hardware Configuration Wizard Location.

Figures 21 – 25 outlines the process to create an Owl 640 II (.cfg) file. After selecting the Hardware Configuration Wizard from the main toolbar, the wizard will pop up. Ensure “Create new configuration” is enabled and click “Next”.

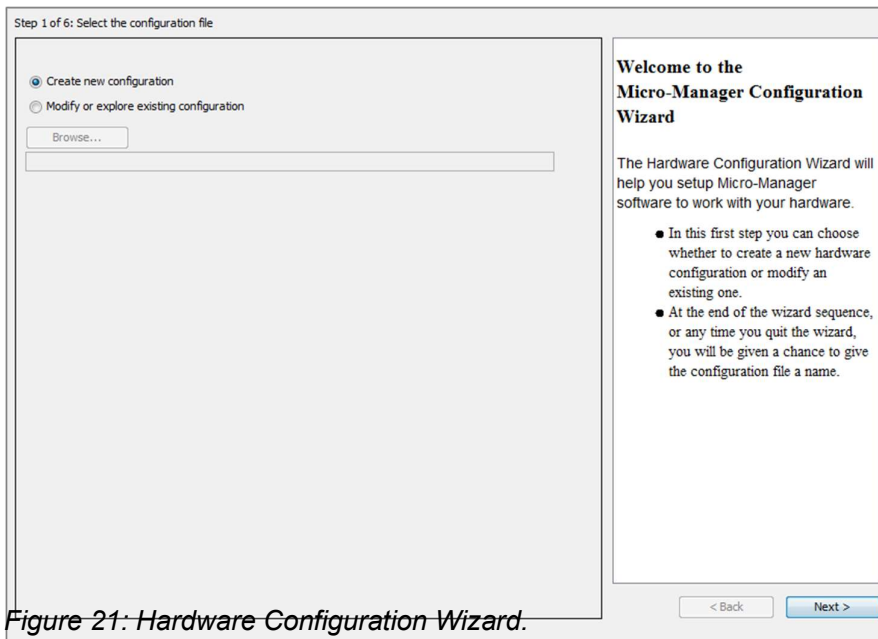

Figure 21: Hardware Configuration Wizard.

Under “Available Devices”, select “Owl Camera 640” from the “RaptorEPIX” folder.

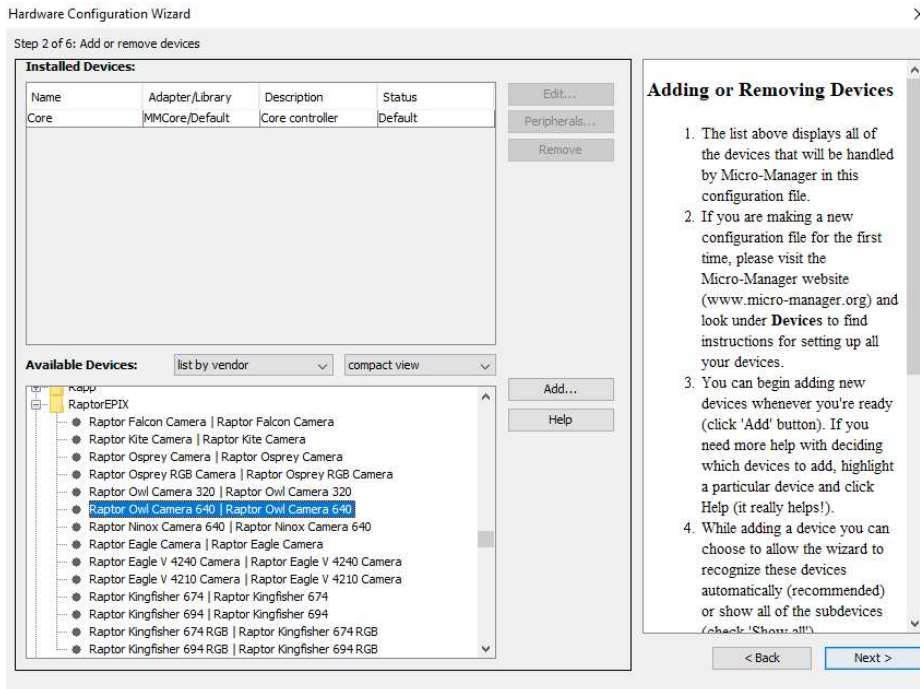

Figure 22: Available Devices.

After selecting the Owl 640 (Owl 640 & Owl 640 II use the same option), a pop up window will appear with the device and property values stated in Figure 23. Click “Ok”.

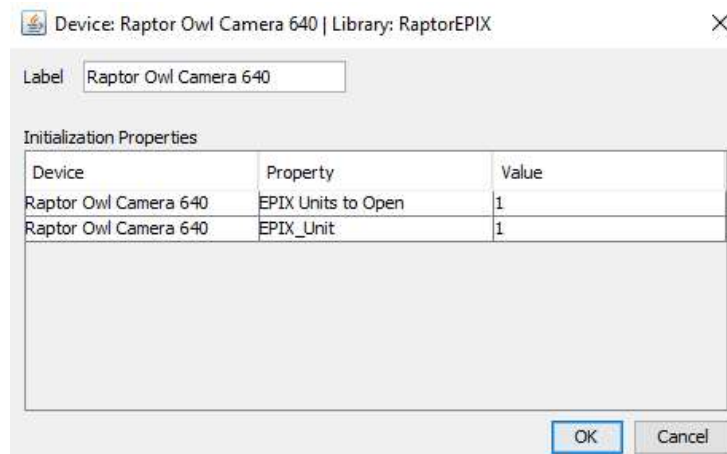

Figure 23: Device and Property Values.

Under “*Installed Devices*”, the Owl 640 II will now be listed (Figure 24). If the software froze on the last stage or an error occurs and the camera is not listed under the installed devices section, then there is an issue with the camera connection, either with the Camera Link or power connection.

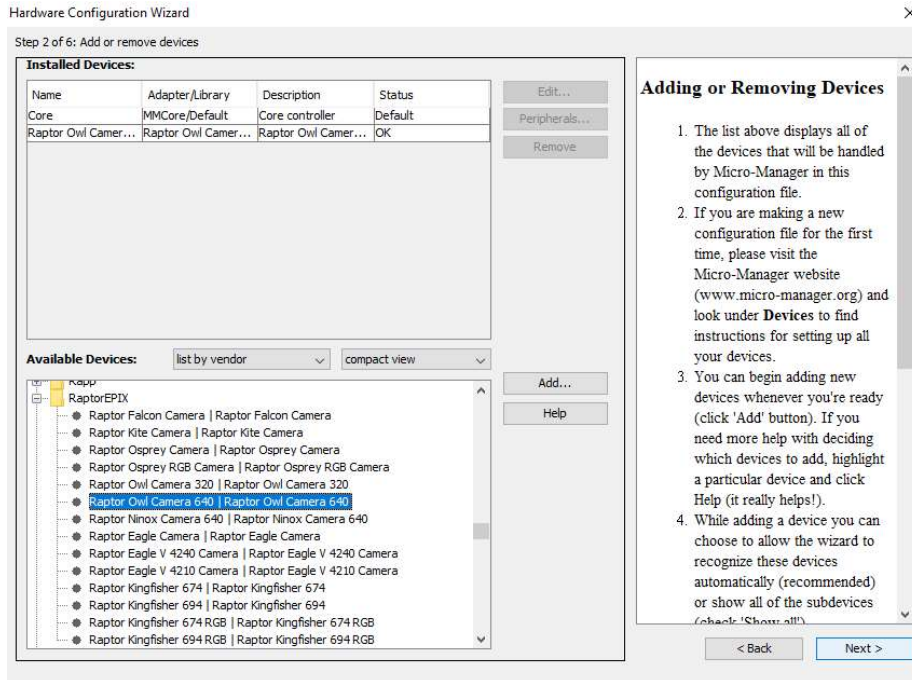

Figure 24: Installed Devices.

The user should now click “Next” multiple times until reaching the window shown in Figure 25. Once at this stage, the final step is to choose the name of the configuration file and where to store it. The common place is to store in the Micro-Manager-1.4 folder, usually stored in “C:\Program Files\Micro-Manager”. After selecting the name and location, click “Finish”.

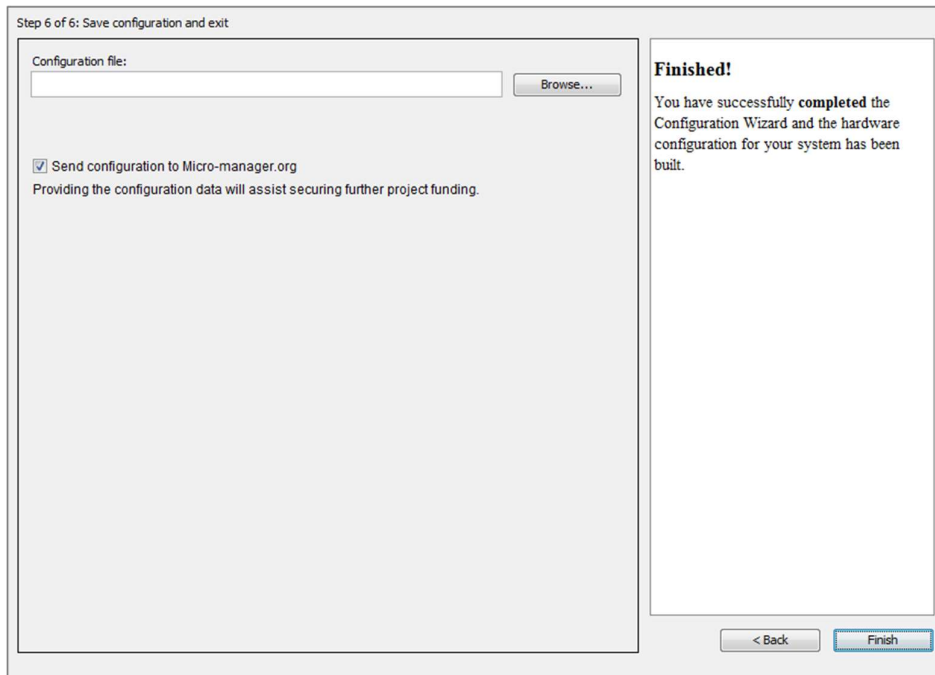

Figure 25: Saving Configuration File.

After finishing the steps outlined above, the user will now be redirected back to the main Micro-Manager window where you can now image and control the camera.

10.3 Pre-made Configuration File

Raptor can supply a premade configuration file that has already been created, with all important controls extracted from the device property browser (section 10.4) to the main Micro-Manager window. To obtain this, please contact Raptor or your local distributor.

When the Owl 640 II configuration file has been obtained (Owl 640 II.cfg), it will have to be stored in the Micro-Manager folder to access it. If the Micro-Manager download was stored in the default section, the configuration file should be stored in the same location:

C:\Program Files\Micro-Manager-1.4\Owl 640 II.cfg

If the software download was stored in a different location during installation, then the configuration file should be stored there.

After performing this process and loading Micro-Manager, the Owl 640 II.cfg file should be listed in the dropdown box of the Start-up Configuration window, as seen from Figure 26. Select this file and click “Ok”.



Figure 26: Start-up Configuration – Falcon III.

10.4 Imaging and Controlling the Camera

The full Micro-Manager User Guide can be obtained from the link below:

https://micro-manager.org/wiki/Micro-Manager_User%27s_Guide

This user guide gives a full breakdown on using all features and analytical tools of Micro-Manager.

To access the controls of the camera, select “*Device Property Browser*” from the “*Tools*” tab on the toolbar of the main Micro-Manager window, shown in Figure 27.

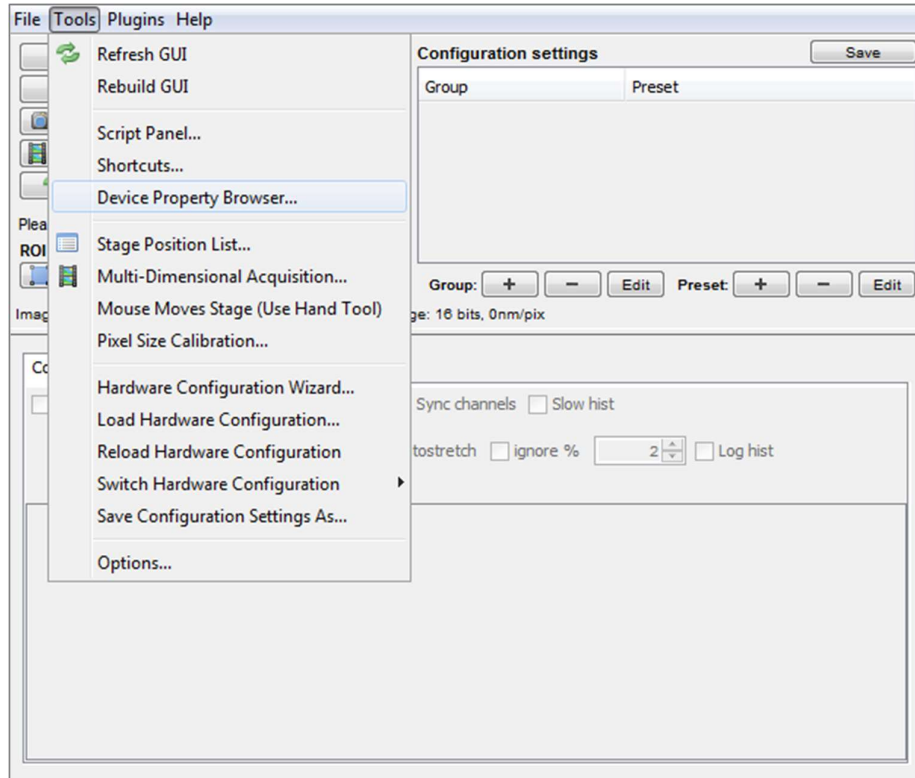

Figure 27: Device Property Browser Location.

The device property browser will now open which gives a detailed list of all camera controls available, shown in Figure 28.

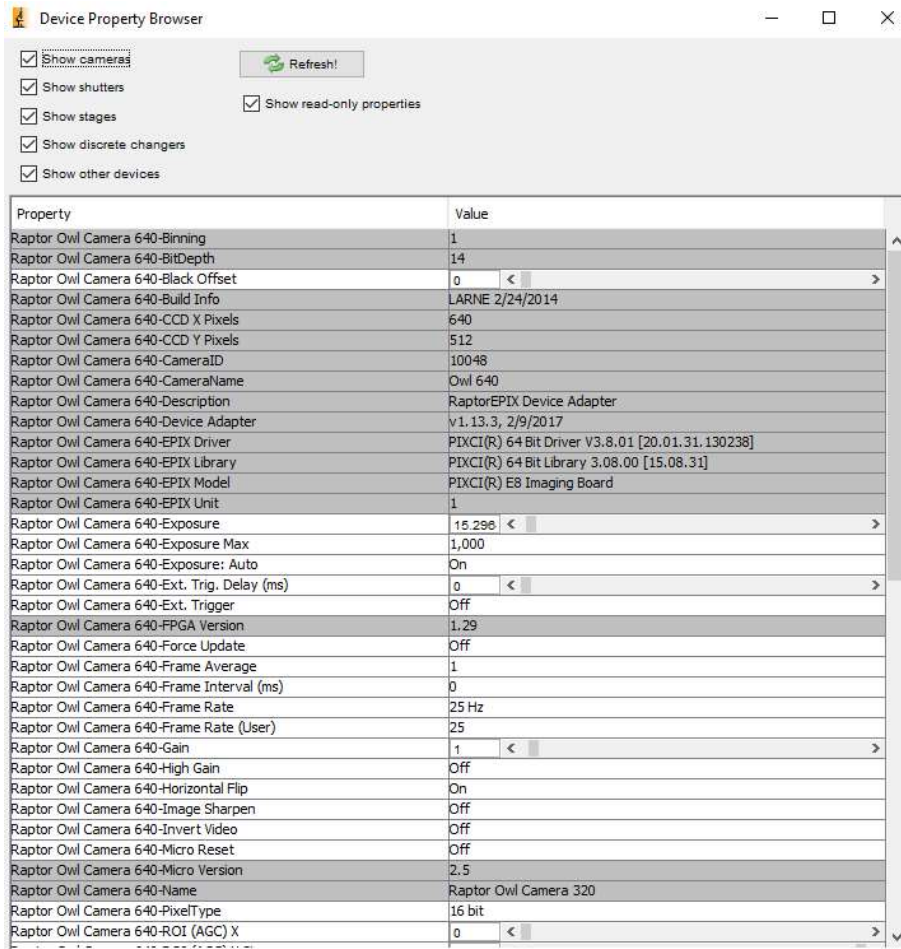

Figure 28: Device Property Browser.

To understand each control parameter of the Owl 640 II, please refer to section 8 that gives detailed and important information of using each camera control and the effect that it has on the camera performance. Please Note that the controls in Micro-Manager are listed in alphabetical order in the device property browser.



CORPORATE HEADQUARTERS

Raptor Photonics LTD
Willowbank Business Park
Larne, Co Antrim
BT40 2SF
Northern Ireland
PH: +44 2828 270141

www.raptorphotonics.com