

SERIES 4000 Precision Dewpointmeters
(Remote, Climatic, RS and TRS)

Users Guide

TABLE OF CONTENTS

1	INTRODUCTION	4
1.1	General	4
1.2	Operating Principle	5
1.3	Calibration	5
1.4	Manufacturing Quality.....	5
2	INSTRUMENT DESCRIPTION	6
2.1	Monitor Front Panel.....	6
2.2	Monitor Rear Panel.....	6
2.3	Sensor Unit.....	6
2.4	Monitor Front Panel Controls	7
2.5	Monitor Rear Panel Controls / Connections	8
2.6	Operation / Standby Modes	8
	2.6.1 Operation Mode	8
	2.6.2 Standby Mode	8
2.7	Manual / Auto Modes.....	9
2.8	Automatic Balance Compensation (ABC)	9
2.9	Manual Balance Compensation	10
2.10	Data Hold	11
2.11	Clean Optics Warning	11
2.12	Max Cool	11
2.13	Display Operation	12
	2.13.1 Upper Display	12
	2.13.2 Lower Display	13
2.14	Pressure Measurement	14
3	INSTALLATION	15
3.1	General	15
3.2	Installing the Monitor	15
3.3	Installing the Sensor	16
3.4	Electrical Connections	16
3.5	S4000 TRS Enclosure	17
	3.5.1 General	17
	3.5.2 Gas Connections	17
	3.5.3 Electrical Connections	17
4	OPERATION	18
4.1	General	18
4.2	Sampling Hints	18

4.3	Which Gases to Measure?	19
4.4	Operating the Hygrometer	19
4.4.1	General	19
4.4.2	Adjusting the Sensor Body Temperature (RS and TRS Models)	20
4.4.3	Adjusting the Balance Compensation System	21
4.4.4	Automatic Operation	22
4.4.5	Manual Operation	22
4.4.6	Effectiveness of the ABC Operation	23
4.5	Additional Operating Guidelines for S4000 TRS	24
4.5.1	Analogue Inputs / Outputs	25
4.5.2	Digital Interface	25
4.6	Direct Measurement of Mirror Temperature	27
4.7	Microscope	27
5	TECHNICAL SPECIFICATIONS	30
5.1	General	30
5.2	Sensor Unit	30
5.3	Monitor Unit	31
5.4	S4000 TRS Enclosure	32
6	MAINTENANCE	33
6.1	Cleaning the Optical System	33
6.1.1	Cleaning Procedure	33
6.2	Refrigeration Unit	34
7	OPTIONS	35
7.1	RS485 Output - Option	35
7.2	Microscope	35
7.3	Remote Pressure Transducer	35
	APPENDIX 1 S4000 Remote Outline Drawings	36
	APPENDIX 2 System Schematic	40
	APPENDIX 3 S4000 Remote Depression Range	40
	APPENDIX 3 S4000 Remote Depression Range	41
	APPENDIX 4 Hazardous Products	42
	APPENDIX 5 Recycling	42
	APPENDIX 6 WEEE & RoHS	42
	APPENDIX 7 Liability	42
	APPENDIX 8 Customer Service Contact Details	43

1 INTRODUCTION

1.1 General

Michell Instruments manufacture a wide range of on-line and portable instruments for the determination of moisture content in air and gases. In addition, the company manufactures Humidity Calibration Systems for Industrial and Scientific users and undertakes custom design-and-build contracts for large scale humidity monitoring and control applications.

The Series 4000 Precision Dewpointmeter is a precision instrument which may be used in Calibration and Standards Laboratories and in exacting process monitoring and control applications where wide humidity range and high accuracy is a prime requirement.

A direct indication of dew point to a resolution of 0.01 °Celsius (°C) is provided by the instrument display, the dew point may also be displayed in a number of other engineering units including °Fahrenheit (°F), Parts Per Million by Volume (ppm(v)), Parts Per Million by Weight in SF₆ (ppm(w) in SF₆), grams per cubic metre (g/m³) and grams per kilogramme (g/kg). Additionally, the instrument can measure and display the gas temperature using an external remote P.R.T. probe (supplied as standard). This temperature may be displayed in °C or °F. Relative Humidity (% rh) may then be calculated from the fundamental gas dew point and temperature at atmospheric pressure. The instrument may also be configured to display measured gas pressure (kPa) using an external pressure transducer, and use this measured pressure to calculate pressure compensated (ppm(v), (ppm(w))SF₆, g/m³ and g/kg.

Experiments conducted by the National Physical Laboratory (NPL) have indicated that, by reference directly to the instrument's resistance thermometer, accuracies of thousandths of a °C. dew point can be observed and repeated.

NPL (Teddington, UK) use a Series 4000 as a Transfer Standard instrument. Also, the National Measurement Accreditation Service (UKAS) use one as a portable Transfer Standard to audit the performance of Humidity Calibration Laboratories.

The Series 4000 is based on the cooled mirror principle and is derived from Michell Instruments' highly successful Transfer Standard Dew-point Hygrometer. This Transfer Standard was developed during the early 1980's in collaboration with the EEC Bureau of Reference as a European link to the National Institute of Standards and Technology (NIST) humidity standard in Washington, USA.

Dew points over the range -100 °C to +80 °C may be measured with the Series 4000 Remote instrument with the relevant auxilliary heating / cooling system, this is equivalent in terms of absolute humidity at atmospheric pressure to a range of 10 ppb(V) to almost 50% V/V (percentage moisture by volume).

In order to measure very low humidities a cooling system may be required, depending on the model this may be a single (RS) or twin (TRS) refrigeration system. In order to measure high humidities the sensor needs to be heated above the dew-point temperature, this is usually achieved by placing the sensor in a heated chamber (climatic sensor).

The use of the single or twin refrigeration systems on the S4000 RS and S4000 TRS models, together with the use of electronic PID temperature control, enables sensor unit operating temperatures as low as -80 °C to be maintained. The low ambient operating temperatures of these refrigerated sensors minimises the uncertainties of

measurement associated with the thermal gradient between sample gas and dew-point temperature. The unique double detection system utilised on the Series 4000 range of instruments, sensing both reflected and scattered light from the cooled mirror surface, ensures the highest precision and repeatability of measurement possible at trace moisture levels.

The Series 4000 Precision Dewpointmeter is also available in an “*Integrale*” configuration, where the dew-point sensor is located in the same unit as the monitor, providing a portable self-contained instrument. The Series 4000 *Integrale* Precision Dewpointmeter uses the same principle of operation as the Remote instrument, except that the measurement range is limited, due to it’s self-contained design. The Series 4000 *Integrale* instrument can be used to measure dew points in the range -60 °C to +35 °C (equivalent to 10.7 ppm(v) (parts per million by volume) to 140,000 ppm(v).

1.2 Operating Principle

Within the sensor a Peltier thermoelectric device cools the plated copper mirror. At a temperature, determined by the moisture content of the sample gas, dew will form on the mirror surface. This formation of dew causes a reduction in reflected light intensity from the red L.E.D. light source and, at the same time, causes an increase in scattered light from the mirror surface. This signal change is perceived by a differential optical detection system which in turn regulates power to the Peltier via a control circuit. The control loop maintains the mirror surface exactly at the dew-point temperature which is then accurately measured by an embedded 4-wire platinum resistance thermometer.

The monitoring electronics performs all the control functions for the sensor as well as measuring and displaying the dew-point temperature. An automatic balance compensation (ABC) system is incorporated in the monitor to eliminate the effects of mirror contamination build-up ensuring continuous accurate operation. If automatic balance is not required on a specific application the ABC system can be switched off and the monitor balanced manually when required.

1.3 Calibration

Michell Instruments’ calibration facilities are amongst the most sophisticated in the world and have been recognised for their excellence by the National Physical Laboratory (NPL) UK. Our humidity calibration laboratory is accredited by UKAS for dew-point measurements in the range -90 to +82 °C dew point (calibration accreditation number 0179). It is also traceable directly to the National Institute of Standards & Technologies (NIST) USA over the range -75 to +20° C dew point. Our full range calibration facility extends from -100 to +90 °C dew point.

1.4 Manufacturing Quality

Your S4000 Hygrometer should reach you in perfect working condition. Michell Instruments are registered with the British Standards Institute for Quality Assurance to BS EN ISO 9001 : 2000. We have rigorous procedures at every stage of production to ensure that the materials of construction, manufacturing, calibration and final test procedures meet the requirements laid down by our Quality System which is approved by BSI.

2 INSTRUMENT DESCRIPTION

The Series 4000 Remote Precision Dewpointmeter comprises of two individual units, a sensor and a monitor, interconnected by three cables carrying the control, optical and measurement signals. The Remote monitor unit is constructed in a 19" 3U sub-rack enclosure, and requires only a mains power supply for operation. The standard sensor unit is housed in a half width 19" 3U sub-rack enclosure and requires only sample gas connections for operation. Other versions of the sensor vary in size, the refrigeration units (RS and TRS models) also require a mains power supply for operation. Refer to Appendix 1.0 for Dimensional Drawings and Section 5.0 for Technical Specification.

2.1 Monitor Front Panel

On the far right of the monitor is the mains POWER switch. The L.E.D. displays and display selection push-buttons are located in the centre of the fascia. The MAX COOL pushbutton, DATA HOLD L.E.D. indicator, and the OPERATION / STANDBY switch are located vertically down the centre of the monitor. The ABC INITIATE push button, MANUAL / AUTO switch, and ABC STATUS L.E.D. indicator are located along the bottom left of the panel. The OPTICAL BALANCE control and meter are located along the top left of the monitor.

2.2 Monitor Rear Panel

It is important that air flow to the vent, located on the rear panel of the monitor, is not obstructed. The operation of the instrument will be adversely affected by preventing sufficient cooling flow.

The three connections to the S4000 Sensor are located on the rear of the monitor, these are labelled SENSOR TEMPERATURE, CONTROL ELECTRONICS, HEAT PUMP. With the exception of a mains power supply and connection of the remote temperature probe if required, these are the only connections required for operation of the instrument.

All user input and output connectors are available on the rear panel of the monitor. These include the RS232 interface, User I/O, and remote pressure input. In addition, the sensor heat pump overload fuse, DIP switches SW2, SW3, and SW4 and the mains power inlet are located on the rear panel.

Sensor Unit

The Sensor Unit contains the dew-point sensing assembly, pipework, and refrigeration system (if applicable).

The mirror and optics, within the sensor, may be accessed from the front of the sensor, for cleaning and maintenance purposes, by un-screwing and removing the microscope housing.

The black blanking plug may be removed from the sensor and a microscope attached to the sensor assembly to allow the formation of ice crystals to be observed by the operator. Refer to Section 4.8.

The dew-point sensing assembly comprises a measurement sample flow-through housing which contains optical signal emission and detection components. These components are accurately positioned around a plated mirror which is mounted on

the Peltier cooling device. If the sensor is a refrigerated model, then the complete sensor assembly is mounted directly to a single or dual refrigeration system.

Sample gas is transmitted into the measurement chamber through stainless steel pipe-work and fittings to ensure negligible contamination of the sample gas.

Both the air inlet and outlet vents are located on the rear of the unit, this allows the instrument to be located in a rack unit above and below other instrumentation whilst maintaining the air cooling flow required for continuous operation.

The sensor mirror is cooled by the Peltier cooling device to below the dew-point temperature until sufficient dew or ice forms on the mirror surface for the optical system to detect. When this point is reached the electronic control circuit adjusts the Peltier device power until the mirror temperature is controlled at the equilibrium value where rate of condensation equals the rate of evaporation - dew point.

2.3 Monitor Front Panel Controls

The following is a basic description of the function of each of the front panel user controls and connections. For further information refer to the relevant Section or Section 4.0.

- a) Mains Power Switch - isolates all power to the instrument and sensor, and includes a visual indication (neon).
 - b) MAX COOL Pushbutton - refer to Section 2.12.
 - c) DATA HOLD L.E.D. - illuminates red when dew-point display and outputs are held. Refer to Section 2.10.
 - d) OPERATE/STANDBY -refer to Section 2.6.
 - e) ABC STATUS L.E.D. - indicates current status of Balance cycle. Refer to Section 2.8. and 2.9.
 - f) MANUAL/AUTO Switch - refer to Section 2.7.
 - f) INITIATE Pushbutton - manually starts a Balance cycle. Refer to Section 2.9.
 - g) Unit Select Pushbuttons
 - h) Upper and Lower display annunciators
 - i) Upper and Lower six digit displays
 - j) OPTICAL BALANCE CONTROL – refer to Section 2.9.
 - k) OPTICAL BALANCE METER – refer to Section 2.9.
- } refer to Section 2.13.

2.4 Monitor Rear Panel Controls / Connections

The following is a basic description of the function of each of the rear panel user controls and connections. For further information refer to the relevant Section or Section 4.0.

- a) RS232 - 9 way "D" type connector for serial communication interface. Refer to Section 4.6.2.
 - b) User I/O - 12 way analogue / digital. Refer to Section 4.6.1
 - c) SW4 ABC Duration - Pre-sets duration of ABC Cycle. Refer to Section 2.9.
 - d) SW3 ABC Frequency - Pre-sets frequency of ABC Cycle. Refer to Section 2.8.
 - e) SW2 Data Hold Duration - Pre-sets duration of dew-point data hold function. Refer to Section 2.10.
 - f) Remote Temperature - Provides input for remote temperature probe (if required). 3-way circular fixed plug connection.
 - g) Remote Pressure - Provides input for Pressure transducer, if required. Refer to Section 2.14.
 - h) Heat Pump Supply Fuse - Overload protection fuse for sensor's Peltier heat pump. Fuse rating T 3.15 A 250V.
 - i) Mains Power Input - I.E.C. Socket for mains supply. Fused at T3.15A 250V.
 - j) Sensor Temperature -
 - k) Control Electronics -
 - l) Heat Pump -
- } Connections to Sensor Unit. Refer to Section 3.4.

2.5 Operation / Standby Modes

2.5.1 Operation Mode

Operation mode is the normal setting of the instrument for dew point measurement.

2.5.2 Standby Mode

This function should only be used for applications where the sample gas dew point changes very quickly from "dry" to "wet" with the possibility of sensor saturation, or in circumstances where a manual measurement is only taken very infrequently and it is preferential to have the sensor disabled between measurements. In this mode the power to the sensor is disabled to allow the sensor to naturally settle at the ambient temperature and so eliminate the possibility sensor saturation.

2.6 Manual / Auto Modes

The instrument may be operated in an automatic or manual mode of operation. The switch on the front panel MANUAL / AUTO sets the mode of operation. The mode may be changed at any time, but the front panel INITIATE push-button is only active when the switch is in the MANUAL position.

In the automatic mode, the instrument initiates an ABC cycle automatically at pre-determined user-definable intervals (refer to Section 2.8.).

In the manual mode, it is the responsibility of the user to manually initiate an ABC cycle periodically.

The front panel OPTICAL BALANCE CONTROL is only active when the AUTO / MANUAL switch is in the MANUAL position. The OPTICAL BALANCE METER is always active.

Important Note: Automatic operation of the Balance Compensation System must not be used if the dew point to be measured is lower than -60°C, or if the sensor temperature is lower than -30°C.

2.7 Automatic Balance Compensation (ABC)

In Operation Mode, the optical components of the sensor (i.e. mirror, light guides etc.) become progressively contaminated which results in a gradual loss of sensitivity. To compensate for this, a compensation system is provided that heats the sensor's mirror to evaporate the condensate and allow the system to measure the mirror's contamination. This provides a new baseline for the dew point measurement until the next ABC is initiated. The duration of the ABC is user definable from 1 to 8 minutes and is set using SW4 – refer to Section 2.9.

The AUTO/MANUAL switch enables automatic or manual initiation of the ABC. In MANUAL an ABC is only initiated by pressing the ABC button, whereas it is initiated periodically in AUTO.

The duration of the ABC is set as follows :

	ABC Duration
SW3-1	30 minutes
SW3-2	1 Hour
SW3-3	2 Hours
SW3-4	4 Hours
SW3-5	8 Hours
SW3-6	16 Hours
SW3-7	32 Hours
SW3-8	N/A

Note that only one switch may be in the ON position at any time.

If the Data Hold facility (see section 2.10) is not used to maintain the measured dew point during an ABC, it is important that the instrument is allowed sufficient time to settle before a dew point reading can be taken. This settling time is dependent on the dew point of the sample gas and the particular application.

2.8 Manual Balance Compensation

If the instrument is being used for calibration applications, or to measure dew points below -60 °C, or in system configurations where the dew-point measurement cannot be interrupted, it is recommended that the automatic balance compensation is disabled to avoid a potential interruption of measurement. It is then the responsibility of the user to periodically initiate a Balance Cycle.

The Balancing Cycle can be initiated, manually, in any of three ways :

- a) manually by pressing the front panel switch INITIATE provided the AUTO / MANUAL switch is in the MANUAL position,
- b) by means of the remote input on the rear of the monitor,
- c) by means of the RS-232 interface.

Once initiated the ABC mode is dependent on the position of the front panel AUTO / MANUAL switch. If it is in the AUTO position the instrument will conduct an automatic balancing cycle, no further adjustment is necessary. If the "AUTO / MANUAL" switch is in the "MANUAL" position then the Optical Balance Control must be adjusted such that the Optical Balance meter indicates centre scale i.e. Balanced.

A Balance Cycle can also be initiated automatically, at pre-determined user definable intervals (refer to Section 2.8.).

The duration of the Balance cycle (manual and auto) is set as follows :

	Balance Cycle Duration
SW4-1	1 minute
SW4-2	2 minute
SW4-3	4 minute
SW4-4	8 minute

- Notes:
1. Only one switch may be in the ON position at any time.
 2. One switch must be in the ON position, otherwise, if an ABC is initiated it will continue indefinitely.

After an ABC cycle is initiated with the AUTO / MANUAL switch in the MANUAL position the Optics need to be balanced manually by the user. This is carried out by observing the OPTICAL BALANCE METER and adjusting the OPTICAL BALANCE CONTROL until the meter indicates centre scale i.e. "BAL".

NOTE

If the instrument is operated in the MANUAL mode, it is important that the OPTICAL BALANCE CONTROL is not re-adjusted during operation. This will cause the instrument to no longer be balanced and may no longer measure the dew point accurately.

2.9 Data Hold

The data-hold facility allows the measured dew-point temperature to be temporarily held during and after an ABC cycle. The measured dew point at the moment the balance cycle starts is maintained for a time period, defined by the user. This time period allows the balance cycle to be completed and the measured dew point to settle before returning to normal measurement mode. This function holds the display, analogue output and digital output for the defined time period, and is activated whenever a Balance cycle is initiated i.e. whether manually or automatically.

Note that the Data Hold time period starts when the ABC cycle starts. Therefore the Data Hold duration time should be set to last longer than this period to allow the instrument to settle on a new measurement, before the data hold function is switched off. This “settling period” will be different for each application, but generally the drier the gas the longer this period will be. For example at -50 °C dew point this settling period may be in the order of 30 minutes, whilst at +30 °C dew point the settling period may only be 1 minute.

The time period of the Data Hold Function is set as follows :

	Data Hold Duration
SW2-1	1 minute
SW2-2	2 minutes
SW2-3	4 minutes
SW2-4	8 minutes
SW2-5	16 minutes
SW2-6	N/A
SW2-7	N/A
SW2-8	N/A

Note that only one switch may be in the ON position at any time.

Note that to disable the Data Hold, all switches SW2-1 to SW2-5 should be in the OFF position.

2.10 Clean Optics Warning

After some time in use, when the optics have collected a considerable degree of contamination, the balance system produces a warning signal demanding that the optics be cleaned. This warning is given by the dual coloured ABC STATUS (L.E.D.) on the Series 4000 Monitor front panel, which will glow red. If this warning is ignored the instrument cannot accurately measure dew point.

2.11 Max Cool

This control is a non-latching push button switch, which over-rides the dew-point control loop system and applies maximum cooling current to the Peltier. The purpose of this control is two fold:

- a) As a functional test. By pressing and holding in the MAX COOL button it is possible to determine what temperature the mirror can be driven down to with reference to sensor body temperature. This temperature will be indicated on the Monitor Unit digital display.
- b) The button may also be used to determine whether or not the instrument is controlling at a dew point or is not able to reach it. This situation could arise when attempting to measure very low dew points without using suitable sensor cooling.

Momentary pressing of the MAX COOL button should cause a dip in the mirror temperature, which, upon release of the button, will provoke the mirror temperature into oscillation around the dew-point value. After a few minutes the mirror should return to its original stable temperature. If this does not happen it may be necessary to consider improving the method of sensor cooling.

2.12 Display Operation

There are two six digit 7-segment L.E.D. displays on the front panel of the monitor unit. These can be configured to display a number of measured and calculated parameters.

Note that all parameters listed in Section 4.6.1. and 4.6.2. are available on the analogue and RS232 outputs, regardless of which are displayed at any time.

During operation, if % rh is selected, the lower display will automatically display the sample gas temperature. The display is configured such that two “calculated” parameters cannot be displayed at any time.

Note that the operation of the display depends on whether the remote temperature probe is connected. If the probe is not fitted, remote temperature and % rh is not displayed and °C/°F mode is selected by the upper “UNIT SELECT” push button.

2.12.1 Upper Display

When the instrument is initially switched ON, the measured dew point in degrees Celsius (°C) is displayed on the upper display. The two-digit annunciator, between the upper “UNIT SELECT” push button and the upper display will display “C” indicating °Cdp.

If the remote temperature probe is fitted, by pressing the upper “UNIT SELECT” push button the upper display may be toggled between measured dew point (°C) and Relative Humidity (% rh). The two-digit annunciator, between the upper “UNIT SELECT” push button and the upper display will display “rh” indicating % rh.

If the remote temperature probe is not fitted, by pressing the upper “UNIT SELECT” push button, the upper display may be toggled between measured dew point in °C and °F. The two digit annunciator will display “F” indicating degrees Fahrenheit.

The “UNIT SELECT” switch will scroll through the functions as follows:

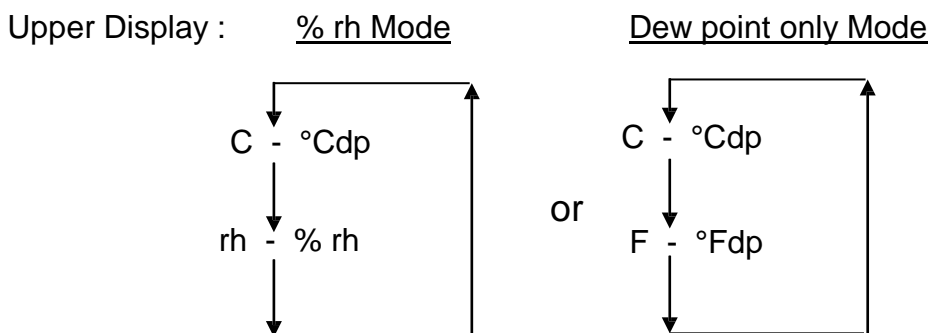

Notes:

1. If the display is configured to °F mode (by means of the lower display), then the upper display will toggle between % rh and °Fdp.
2. When % rh is selected on the upper display, the lower display automatically displays Sample Gas Temperature either in °C or °F.

2.12.2 Lower Display

When the instrument is initially switched ON, the water content in ppm(v) (Parts Per Million by Volume) is displayed on the lower display. By pressing the lower “UNIT SELECT” push button the function of the lower display will change to display one of the following :

- Parts Per Million by Weight in SF₆ (ppm(w))
- Parts Per Million by Volume (ppm(v))
- Grams per cubic metre (g/m³)
- Grams per kilogramme (g/kg)
- Pressure (kPa)
- Sample Gas Temperature (°C)
- Sample Gas Temperature (°F)

The “UNIT SELECT” switch will scroll through the above functions as follows :

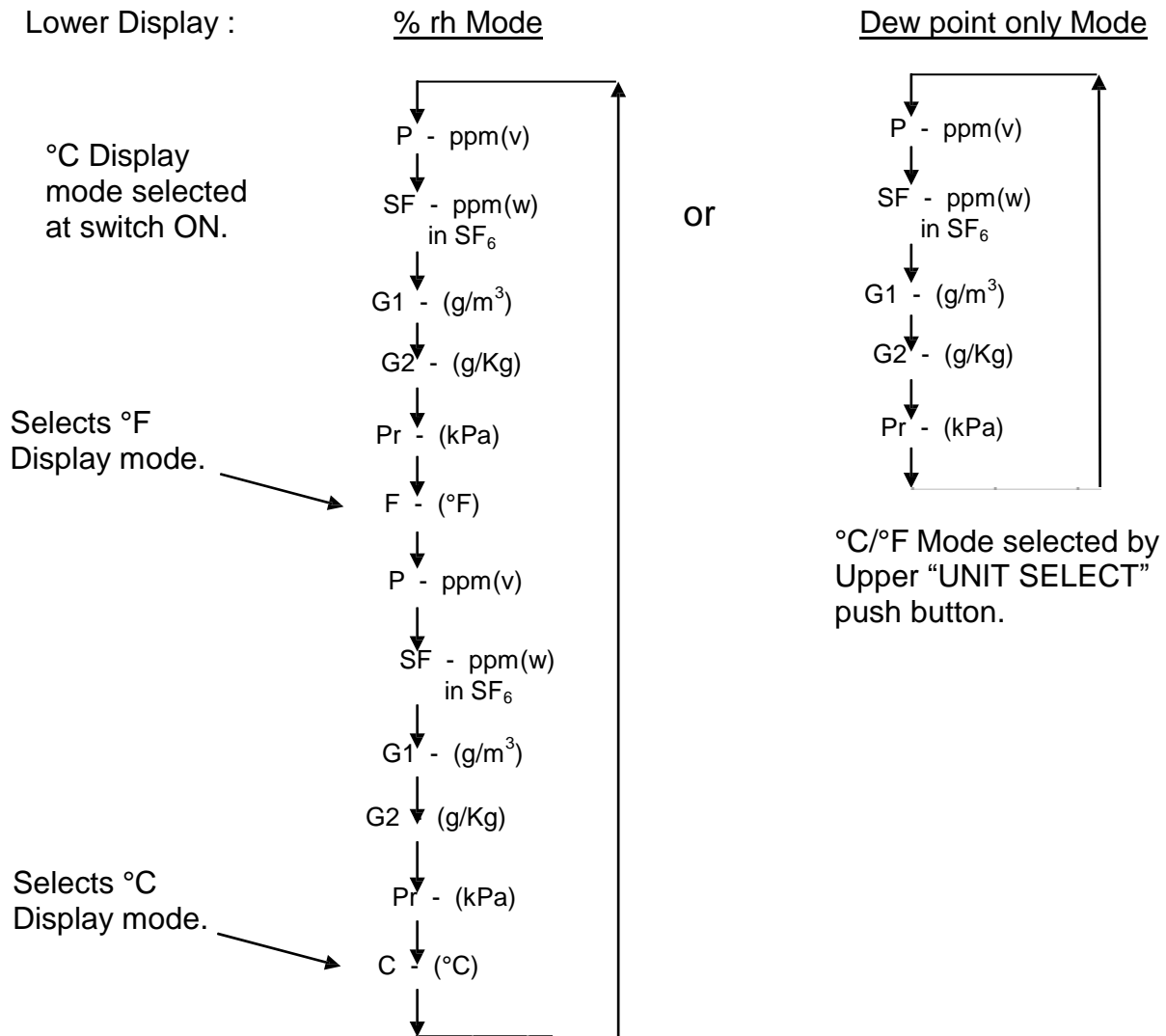

Notes

1. If a pressure transducer is not connected to the instrument, then by default, atmospheric pressure (101.3 kPa) is selected and displayed.
2. During a data hold cycle the measured dew-point reading is held and therefore the ppm(v), ppm(w), g/m³, and g/kg parameters will also be temporarily held. The sample gas temperature and pressure parameters are not held.
3. If the upper display is indicating % rh, and the lower "UNIT SELECT" push button is pressed, then ppm will be displayed, and the upper display reverts to dew point in either °C or °F.

2.13 Pressure Measurement

A remote pressure transducer may be connected to the S4000 Remote Monitor. This allows on-line measurement and display of the sample gas pressure, as well as calculation of pressure compensated ppm(v), ppm(w), g/m³, and g/kg.

If a pressure transducer is not connected to the instrument, a default pressure of 101.3 kPa (atmospheric pressure) is assumed, and all pressure dependent parameters are calculated using this pressure.

The pressure is displayed in kPa, and is available as a digital output on the RS232 interface. Refer to Section 4.6.2.

The standard pressure range is 0 to 50 p.s.i. absolute, but particular pressure ranges may be supplied to order. Contact Michell Instruments" Technical Sales Department for further information.

Remote Pressure Connection

A 6 pin circular socket (type Hirose RM12B Series Bayonet) on the monitor unit rear panel marked „REMOTE PRESSURE" provides the supply voltage (+15V) and signal input voltage (1-6V) scaled over the range 0-50psia required for the pressure measurement circuit .

Pin connections are as follows:

<u>Pin Number</u>	<u>Function</u>
1	N/C
2	N/C
3	N/C
4	Signal I/P
5	0V
6	+V

3 INSTALLATION

3.1 General

The Series 4000 Precision Hygrometer is supplied with a full accessory package. Please check that you have received all the items listed on the Packing Check List.

Both the Monitor and Sensor Units (if applicable) have single 3 pin I.E.C. plug connections for the mains supply.

Note that the S4000 TRS model is supplied in a self-contained enclosure. The connections and dimensions are different for this model, refer to Section 3.5.

The monitor unit has a universal power supply, capable of operating from any mains supply between 90 to 260 Volts A.C.

The Sensor Unit, if fitted with a refrigeration system, will require a mains power supply. Due to the nature of the refrigeration system the power supply voltage is factory set. The power supply voltage setting cannot be changed by the user. Contact Michell Instrument's Technical Sales Department for advice.

The factory set power supply voltage is indicated on the yellow label located on the rear of the unit.

Two power leads are supplied, fitted with 3 pin IEC socket for connecting onto the monitor and sensor units. Suitable fused power plugs, conforming to local electrical safety regulations, must be fitted to the free end of the cables. The power leads are approximately 2 metres long with 3 cores colour coded as follows:

Brown	- Live
Blue	- Neutral
Green/Yellow	- Earth

WARNING!: *This instrument must be connected to electrical earth for safety.*

3.2 Installing the Monitor

The Series 4000 Precision Hygrometer monitor requires an operating environment of 0 to 40 °C, 0 to 90 % rh.

The monitor case is designed for 19" 3U rack mounting. However, it can be used as a bench mounted device without any special preparation.

For rack mounting, simply screw the monitor front panel to the front of the rack using 4 of M6 x 15mm screws and plastic inserts. The unit should be supported by suitable horizontal runners, the front panel fixings alone are not sufficient to suspend the weight of the entire unit.

NOTE: A minimum depth behind the S4000 front panel of 511 mm is required for the monitor, its connectors and wiring. Also, it is important that a sufficient flow of ambient air is allowed at the rear of the unit.

3.3 Installing the Sensor

Sample gas connections are made through pipe couplings marked "GAS IN" and "GAS OUT". These couplings are suitable for use with 6mm O.D. stainless steel or P.T.F.E. tubing. If the vent gas is not routed to another test set or measuring instrument then lower quality tubing may be used on the "GAS OUT" port.

Before operation, the sensor mirror and optical surfaces should be cleaned as described in Section 6.1.

3.4 Electrical Connections

Refer to the rear panels of the Series 4000 Remote Monitor and Sensor Units in Appendix 1.0.

For operation, the only connections required are :

- a) Sensor Temperature inter-connection from Sensor Unit to Monitor Unit.
- b) Control Electronics inter-connection from Sensor Unit to Monitor Unit.
- c) Heat Pump inter-connection from Sensor Unit to Monitor Unit.
- d) Mains supply to Monitor.
- e) Mains supply to Sensor Unit (if applicable).

The three interconnection cables from the Sensor Unit to the Monitor Unit are supplied (standard length 2 metres).

A 2 metre power cable is supplied, as standard, for each unit requiring a mains supply. A suitable fused power connecting plug, conforming to local electrical safety regulations, must be fitted to the free end of each cable.

IMPORTANT: Before connecting the monitor and sensor units to an A.C. power source ensure that the mains supply is within the limits of the operating voltage specified on the rear of the unit.

Once the power cable and three inter-connection cables are connected, and the sample gas connections are made and checked, the instrument is ready for operation.

If indication of % rh relative humidity and remote gas temperature are required, the remote P.R.T. probe should be placed in the gas flow, and the probe connected to the connector on the rear of the unit.

Further electrical connections for analogue or digital I/O may be required, refer to Section 4.6.

3.5 S4000 TRS Enclosure

The S4000 TRS model is supplied, as standard, in a 19" enclosure. The instrument is completely housed within an equipment cabinet, fitted with castors for ease of movement. The S4000 Sensor and Monitor are connected together internally. The only connections needed in order to operate the system is a sample gas and mains power supply.

Note: A minimum depth behind the equipment cabinet of 100mm must be maintained to allow sufficient airflow over the refrigeration system.

3.5.1 General

The sample handling system of the S4000 TRS is optimised to maintain the integrity of the gas flow being measured through the use of the highest grade materials and fittings. Whilst perfected for trace moisture analysis, the TRS retains the capability for measurements of any dew-point temperature up to +20°C.

The S4000 TRS Monitor is identical to the standard S4000 Monitor in all respects.

3.5.2 Gas Connections

The sample gas connections are made through stainless steel tube fittings located on the front panel of the enclosure marked "GAS IN" and "GAS OUT".

The GAS IN connection is a *Cajon* type VCR metal gasket face seal fitting suitable for 1/4" OD stainless steel tubing.

The GAS OUT connection is a *Swagelok* type twin ferrule compression tube fitting suitable for 1/4" OD stainless steel tubing.

3.5.3 Electrical Connections

The factory set power supply voltage is indicated on the yellow label located on the rear panel of the unit. The power supply voltage setting cannot be changed by the user. Contact Michell Instruments' Technical Sales Department for advice.

A single 3 pin IEC plug is available on the rear panel of the instrument for connecting to the appropriate power supply.

A power lead is supplied fitted with a 3 pin IEC socket for connecting onto the instrument. A suitable fused power plug, conforming to local electrical safety regulations, must be fitted to the free end of the cable. The power lead is approximately 2 metres long with 3 cores colour coded as follows:

Brown	- Live
Blue	- Neutral
Green/Yellow	- Earth

WARNING!: *This instrument must be connected to electrical earth for safety.*

For 100 V to 115 V 60 Hz Working Voltage Only

An additional 3 pin IEC fused plug is available on the rear panel of the instrument for connecting to the appropriate power supply. This is due to the high current loading from the in-built refrigeration system. An additional 2 metre long power lead is supplied.

4 OPERATION

4.1 General

Operation of the Series 4000 Remote Precision Hygrometer is very simple as long as necessary precautions are taken to provide an accurate sample of the gas to be measured. Statistical information indicates that the vast majority of failures are caused either by incorrect sampling methods, sampling positions or inadequate protection against dangerous substances.

4.2 Sampling Hints

The Series 4000 Precision Hygrometer sensor is designed to operate in a flowing gas stream. It is provided with a sampling chamber which enables a small sample of gas to be passed over a Peltier cooled, plated copper mirror. The sample gas is bled off to atmosphere through the Sensor Unit front panel coupling marked "GAS OUT".

Although the correct operation of the sensor is not flow-rate dependent it is important to ensure that the flow velocity through the sample line, connecting the sample source to the Sensor Unit, is high enough to avoid long time lags in response to changes in humidity at the sample source. We therefore recommend a flow rate of between 0.3 to 0.7 Litre / minute be set, the ideal figure being 0.5 Litre / minute.

Flow regulation is not provided within the Sensor Unit. If gas flow must be regulated, add a precision needle valve or similar device at a suitable location in the sample gas stream **before** the "GAS IN" coupling on the unit. Take care not to introduce errors into the system by using inferior quality valves or making poor connections. Avoid pressure gradients in the system by excess flow restriction after the sensor. If the test gas has a very high flow rate then a by-pass arrangement is preferable to a flow restriction after the sensor.

The general rules to be adhered to when arranging a sampling system are as follows:

- a) Ensure the sample is representative of the gas under test.

The sample point should be as close to the critical measurement point as possible. For example, in a glove box application connect the sensor at the exit of the glove box not at the gas entry point.

- b) Minimise dead space in sample lines.

Try to avoid too many "T" pieces or unnecessary pipe-work. Where possible, build up the sampling pipe specifically for the job and do not use pipe-work previously installed for another application. Dead space in sample lines increases response time by holding water molecules which are more slowly released to the passing gas sample.

- c) Remove any particulate matter or oil from the gas sample.

Particulates entering the sensor measurement chamber will cause contamination of the sensitive optical components, this will result in the need for more frequent cleaning of the sensor optics. If particulates such as degraded desiccant or pipe swarf and rust are possible, use a particulate in-line filter. Michell instruments' technical sales staff will be pleased to give advice.

d) Use high quality sample pipe fittings.

We would recommend that, wherever possible, stainless steel pipe-work and fittings are used. This is particularly important at low dew points since other materials have hygroscopic characteristics and absorb moisture in the pipe walls. Absorbed moisture will slow down measurement response and, in extreme circumstances, giving false dew-point readings.

For temporary applications, or where stainless steel pipe-work is not feasible, use high quality thick-walled p.t.f.e. pipe which exhibits similar characteristics to stainless steel.

Always use the shortest run of pipe-work possible between two points. Use the smallest diameter pipe-work possible to reduce response time. But, take care not to induce pressure differentials by aiming for too high a flow-rate through small bore pipe-work. A sample flow-rate between 0.3 and 0.7 litres per minute will be satisfactory for the Series 4000 Remote Dew-point Hygrometer to operate correctly.

4.3 Which Gases to Measure?

The Series 4000 Remote Precision Hygrometer, by nature of its design, is suitable for measurement of the moisture content of a wide variety of gases. In general, if the gas (in conjunction with water vapour) is not corrosive to base metals then it will be suitable for measurement by the Series 4000 Remote Precision Hygrometer. However, gases containing entrained solids should be filtered before presentation to the Series 4000 Sensor.

Care should be taken with gas mixtures containing other potentially condensable components in addition to water vapour to ensure that only water can condense onto the cooled mirror surface.

High purity gases will not be contaminated by the Series 4000 Sensor Unit. Components which are likely to out-gas (epoxy, most plastics etc.) are not used in the manufacture of the sensor. Therefore, the instrument is safe for use in critical semiconductor and fibre optic applications.

While the Series 4000 Sensor is designed to be operated at atmospheric pressure each sensor is factory tested to a sample gas pressure of 10 p.s.i.g before any calibration work is undertaken. In its standard form, the sensor unit is not suitable for measuring samples below atmospheric pressure.

4.4 Operating the Hygrometer

4.4.1 General

Use the following instructions with reference to the front panel of the Series 4000 Remote Monitor Unit, and the functional descriptions provided in Section 2.0.

Check that the sensor optics are clean as described in Section 6.0. If the optional microscope is not being used ensure that the black blanking plug is screwed into the microscope fitting on the front of the Sensor Unit to prevent stray light from interfering with the optical detection system. Set the sample gas flow-rate to between 0.3 and 0.7 litres per minute.

The temperature measurement and % rh calculations within the instrument are fully automatic and do not require any user adjustment or maintenance.

When the Monitor Unit is switched ON a red neon illuminates in the power switch and the digital display should illuminate.

If the instrument is an RS or TRS model, when the Sensor Unit is switched ON the temperature controllers" digital display should illuminate. The Sensor Unit is fitted with a two or three position power switch, depending on the model :

S4000 RS :

- i) Up position is off.
- ii) Down position switches on the temperature controlled refrigeration system.

S4000 TRS :

- i) Centre position is off.
- ii) Down position switches on the temperature controlled refrigeration system.
- iii) Up position switches off the refrigeration system but still operates the temperature control circuit. This facility is provided to enable the sensor body temperature to be warmed-up in order to measure dew-point temperatures in the region 0 to +20 °C and also for maintenance purposes.

NOTE: *The refrigeration system may be set for operation above 0 °C, up to 20 °C, for short periods only (up to 30 minutes). This allows dew points in the region 0 to +20 °C to be measured and also for the sensor to be warmed-up for maintenance purposes.*

WARNING: *Do not switch the refrigeration system on until at least 4 hours after final installation. This time is required to allow the compressors' fluid to drain. If the compressors' have been exposed to very cold conditions prior to installation this time must be extended to about 12 hours.*

Failure to observe this precaution may result in permanent damage to the refrigeration systems' compressors.

4.4.2 Adjusting the Sensor Body Temperature (RS and TRS Models)

A CAL 3200 Autotune PID Temperature Controller is included which enables the user to set the sensor body temperature above the dew-point temperature to be measured.

To adjust the sensor body temperature press and hold down the "*" button on the temperature controller and then press either "▲" or "▼" buttons to change the temperature set-point. Control functions are as follows:

- * View set-point
- ▲ Increase set-point
- ▼ Decrease set-point

The sensor body temperature must always be above the dew-point temperature, if not condensation will occur in the sensor measurement chamber and internal sample system pipes. This means that before changing to wetter dew points the sensor body temperature must be raised and allowed to stabilise at the new temperature.

WARNING

Do not set the CAL 3200 to temperatures above 0 °C for periods of no longer than 30 minutes, as this will result in damage to the refrigeration system.

Note: Always ensure that the sensor body temperature is set to at least 20°C above the dew point being measured, up to -20°C dew point to avoid any chance of condensation. For dew points above -20°C a 10°C differential is satisfactory.

Recommended sensor body temperature settings for dew-point measurements over the full range of the instrument are:

Measured Dew Point	Sensor Body Temperature	
-100	-80	(S4000 TRS Only)
-90	-70	
-80	-60	Sensor unit power switch in the „DOWN“ position (refrigeration unit switched on) Note: The lowest sensor temperature that can be set on the S4000RS is -40 °C approx.
-70	-50	
-60	-40	
-50	-30	
-40	-20	
-30	-10	
-20	0	
-10	0	Sensor unit power switch in the „UP“ position (refrigeration unit switched off)
0	21	
10	21	
20	21	

Note: The sensor head temperature can be warmed up quickly by switching off the refrigeration unit (switch in the ‘up’ position) and adjusting the temperature set-point up in 30 °C steps, allowing 10 minutes between set-points.

4.4.3 Adjusting the Balance Compensation System

Upon first switching ON the instrument, set the AUTO / MANUAL switch to MANUAL and press the INITIATE button to manually initiate a balance cycle. The dual coloured ABC STATUS (L.E.D.) will glow green. Note: it may glow amber if the Dew-point Meter is not already balanced or, flash amber for an instant at the start of a balance cycle until dew or frost, if present, on the cooled mirror surface is evaporated.

Adjust the Optical Balance Control such that the Optical Balance meter indicates centre-scale i.e. balanced. This compensates the ABC system for the current level of contamination of the optical system.

Check that during the Balance Cycle the ABC Status L.E.D. is illuminated green when the Optical Balance Meter indicates "BAL". When the Balance cycle is complete the ABC Status L.E.D. will be distinguished, if the ABC L.E.D. is illuminated red this indicates that the ABC system has not been balanced successfully.

If the instrument is required to operate in an Auto-Balancing mode, set the AUTO / MANUAL switch to AUTO.

4.4.4 Automatic Operation

For process monitoring and control applications the instrument should be operated in "automatic balance mode", i.e. the ABC configured to initiate a balance cycle after a pre-determined time. This time will depend on the application, generally the drier and cleaner the gas the longer the ABC frequency. For most applications an ABC frequency of 4 to 8 hours is realistic.

The ABC system will self-initiate and compensate the control electronics for build-up of contamination on the optical surfaces. Also, it will illuminate a front panel red alarm L.E.D. - ABC STATUS (L.E.D.) when the optics loop can no longer compensate for optical contamination.

In many process applications dew-point changes will be sufficiently slow for the instrument to track the dew point giving continuous instantaneous monitoring.

If AUTO balance operation is required the relevant timing switches should be set on the rear panel of the unit. Refer to Section 2.8.

4.4.5 Manual Operation

Operation of the balance system in its MANUAL mode allows the user to manually initiate a balance cycle instead of allowing the instrument to perform this task at set time intervals. Manual balance of the optics system to compensate for any increase in contamination is totally under the control of the operator.

To set the instrument in manual mode set the front panel AUTO / MANUAL switch to MANUAL.

As detailed earlier, a balance cycle can be initiated by the front panel switch INITIATE, by the analogue input or via the RS-232 interface.

For laboratory use or calibration work it may be desirable to operate the Series 4000 in its manual mode. The following advantages are gained:

- (a) Faster response, especially at high dew points.
- (b) Wider optics control range, important for high temperature operation.
- (c) Balance system is initiated manually preventing interference with critical measurements.

4.4.6 Effectiveness of the ABC Operation

Observe the OPTICAL BALANCE CONTROL meter and the ABC STATUS (L.E.D.) on the Monitor Unit front panel. In normal operating mode the meter pointer will be towards the left-hand side of the meter or, even off-scale. This reflects the magnitude and direction of the current applied to the Peltier cooling device (heat pump) which is cooling the mirror. The ABC STATUS (L.E.D.) should not be illuminated.

When an AUTO balance cycle is initiated automatically by the instrument the ABC STATUS (L.E.D.) will glow amber and the OPTICAL BALANCE CONTROL meter pointer will swing off-scale to the right. As moisture evaporates from the sensor mirror surface the pointer will move slowly back towards a point just right of the centre on the meter scale. At about 70% of meter full-scale reading the ABC STATUS (L.E.D.) will glow green only.

This indicates that the ABC system has sufficient control range to compensate for contaminated sensor optics and has correctly balanced the instrument. When the ABC cycle is complete the ABC STATUS (L.E.D.) will extinguish altogether.

If, after completion of the balance cycle, mirror and optics contamination are too great the ABC STATUS (L.E.D.) will glow red indicating that optics cleaning is required (refer to Section 6.0).

When the instrument is being used in MANUAL balance mode, visual signs of a balance cycle operating are similar to those described for an AUTO balance cycle. To initiate a MANUAL balance cycle set the AUTO / MANUAL switch to the MANUAL position then press the INITIATE button. As before, the ABC STATUS (L.E.D.) will glow amber and the OPTICAL BALANCE CONTROL meter pointer will move off-scale. As moisture evaporates from the mirror surface the pointer will move back towards the centre of the meter scale. After approximately one minute the pointer should stop moving. When there is no further movement adjust the OPTICAL BALANCE CONTROL potentiometer, to the left or right, so that the meter pointer

rests in the centre of the meter scale (zero position). The ABC STATUS (L.E.D.) should now be indicating green. When the balance cycle is complete the ABC STATUS (L.E.D.) will extinguish and the instrument will return to measurement mode.

If, during MANUAL balance, the OPTICAL BALANCE CONTROL meter cannot be adjusted to zero then there is excessive contamination on the sensor mirror surface and optics. In this case, when the balance cycle is complete, the ABC STATUS (L.E.D.) will glow red requesting cleaning of the optics and of the mirror surface (refer to Section 6.0).

Note: When the instrument is being operated in the MANUAL mode it is very important that the OPTICAL BALANCE CONTROL potentiometer is not adjusted following completion of a balance cycle.

4.5 Additional Operating Guidelines for S4000 TRS

When operating the S4000 TRS Precision Dew-point Hygrometer the following further operating guidelines should be considered :

1. For measurement of dew points below -10°C the S4000 TRS sensor unit refrigeration system should be operated - failure to do so may result in overheating and possibly damaging the sensor body.
2. When purging the sensor with dry gas during periods when measurements are not being made - then the instrument should be switched off, this means both the monitor and sensor.
3. When preparing the instrument to make a measurement, the following sequence should be assumed:
 - a) Purge the sensor body with sample gas.
 - b) Switch on the S4000 TRS sensor unit refrigeration system and set the sensor body temperature to the required value (refer to Section 4.4.2.) and allow to stabilise.
 - c) Switch on the S4000 monitor unit, adjust the balance compensation system (refer to Section 4.4.3.).
4. During the operation of the instrument, if the sensor body temperature is changed by more than 20°C then the balance compensation system should be adjusted for the new operating conditions.
5. The black plug, into which the microscope screws, contains a small amount of desiccant. The desiccant is behind the mesh, next to the window.

The purpose of the desiccant is to dry the air inside the black plug and microscope, therefore preventing water or ice condensing inside.

If the microscope is not used the push fit plug should be used to fill the hole. It is important that the hole be plugged at all times to prevent the desiccant absorbing moisture from the atmosphere, as it will quickly become saturated. If the plug or microscope is removed while the sensor is at negative temperatures, ice will form on the window because it too will be close the sensor temperature.

Note that any ice forming on the window will have no effect on the measured dew point.

User Inputs / Outputs

4.5.1 Analogue Inputs / Outputs

The monitor unit has fitted, as standard, the following inputs and outputs. These are available on the “User I/O” connector located at the rear of the monitor unit.

Pin Number	Function	Range	Notes
1	0V Analogue		
2	Dew point 4-20 mA	Refer to Section 5.3	Max 500 Ω Load
3	Dew point 10mV/ °C	-100 to +100 °Cdp	
4	Temperature 4-20 mA	-50 to +50 °C	Max 500 Ω Load
5	Temperature 10 mV/ °C	-80 to +80 °C	
6	% rh 4-20 mA	0 to 100 %	Max 500 Ω Load
7	% rh 0 – 1 V D.C.	0 to 100 %	
8	0 V Digital		
9	Data Hold TTL	5V = Data Held	Digital Output
10	ABC TTL	5V = Balancing	Digital Output
11	Optics Alarm	5V = Alarm	Digital Output
12	Remote ABC Initiate	0V to initiate	Input

The “USER I/O” connector located on the Monitor rear panel is a 12 way screw-terminal type and accepts wire pin or bare wire connections.

4.5.2 Digital Interface

The monitor unit has fitted as standard an RS-232 output interface. RS-485 may be fitted as an option. Refer to Section 7.1.

The 9 pin "D" type socket connector on the monitor unit rear panel marked “RS 232” has the following pin connections :

Pin Number	Function
1	N/C
2	Transmit data (TXD)
3	Receive data (RXD)
4	N/C
5	Signal Ground (GND)
6	N/C
7	Clear to send(CTS)
8	Request to send (RTS)
9	N/C

The serial link has the following protocol:-

9600 baud rate
 8 data bits
 1 stop bit
 No parity.

The following parameters may be read via the RS232 interface :

- Dew point (°C)
- Dew point (°F)
- Water Content (ppm(v))
- Water Content in SF₆ (ppm(w))
- Water Content (g/m³)
- Water Content (g/kg)
- Pressure (KPa)
- Relative Humidity (% rh)
- Temperature (°C)
- Temperature (°F)

To initiate data transfer from the S4000 instrument, it should to be sent a request command.

The commands are :

dpc <CR>	or	DPC <CR>	for Dew point in °C.
dpf <CR>	or	DPF <CR>	for Dew point in °F.
ppm <CR>	or	PPM <CR>	for Water Content in ppm(v).
sf6 <CR>	or	SF6 <CR>	for Water Content ppm(w) in SF ₆ .
gm3 <CR>	or	GM3 <CR>	for Water Content in g/m ³
gkg <CR>	or	GKG <CR>	for Water Content in g/kg.
prs <CR>	or	PRS <CR>	for Pressure in kPa.
rh <CR>	or	RH <CR>	for Relative Humidity in %.
tpc <CR>	or	TPC <CR>	for Temperature in °C.
tpf <CR>	or	TPF <CR>	for Temperature in °F.

(CR = carriage return (13 ASCII))

The S4000 instrument will respond with, for example, the following:-

-15.47 deg C
 or
 27.56 deg F
 or
 5347.97 ppm(v)
 or
 110.76 ppm(w) SF6
 or
 3.76 gM3
 or
 4.52 gKG
 or
 101.3 Kpa
 or
 25.7 % rh
 or
 72.68 C
 or
 -42.39 F

Additionally, a Balance cycle may be initiated through the RS232 interface.

To initiate an ABC the request command is **abc**<CR> or **ABC**<CR>

4.6 Direct Measurement of Mirror Temperature

The sensor P.R.T. may be read directly using a suitable external resistance bridge. This can be achieved by temporarily disconnecting the cable connecting the sensor PRT to the S4000 Monitor Unit.

The 6 pin circular connector plug (type Hirose RM12B Series Bayonet) marked TEMPERATURE MEASUREMENT on the rear of the Sensor Unit provides the 4-wire dew-point PRT output (normally connected to the S4000 Monitor).

The cable between the S4000 Sensor and Monitor must be reconnected to resume normal operation on the instrument.

The pin connections are as follows:

<u>Pin Number</u>	<u>Function</u>
1	PRT high 1
2	PRT low 1
3	PRT low 2
4	N/C
5	PRT high 2
6	N/C

4.7 Microscope

It is possible in certain circumstances that between 0 and -20 °C. super-cooled water may form on the mirror surface instead of ice. The theory for this phenomenon is quite complex but the effect is that, for a sample of fixed water vapour concentration, the controlled mirror temperature is affected by as much as 2°C. Super-cooled water formation leads to dew-point values lower than would be seen if ice crystals were formed. If you require further advice on this matter please contact Michell Instrument's Technical Sales Department.

The microscope allows direct viewing of condensate on the mirror surface providing visual evidence that ice crystals have formed in the critical region between 0°C and -20°C dew point.

The microscope is fitted into the sensor cover by replacing the Black screw-threaded plug with the microscope. Ensure the instrument is measuring a dew point then screw the microscope into the sensor cover until sharp focus of the mirror surface is achieved. As a guide to the focal point, the microscope should only have about four to five threads showing when it is screwed in. Fine adjustment will be necessary to obtain sharp focus.

When the instrument is controlling at a dew point, condensation is seen on the mirror as small bright red specks on a dark background. Liquid water is seen as rounded droplets and ice as sharp-edged crystals.

When using the microscope to observe ice formation on the mirror surface from time to time it may be possible to detect differences in the crystalline formation of the ice. When the instrument is measuring at trace moisture levels the physics affecting the nucleation of ice crystals on the mirror surface are markedly different to those that apply at higher moisture levels. The phenomena are sometimes referred to as "**Good Ice**" or "**Bad Ice**".

The effect of these ice formations can be significant to the user as they directly affect the accuracy of the measurement being made. It is therefore important that the user is aware of the measurement errors that can occur, can identify the differences in formation and can use the appropriate technique to force a good formation, and by so doing achieve an accurate dew point measurement at all times.

At very low dew point temperatures the difference between the steady state measured value on “Bad Ice” compared to “Good Ice” can be as much as -1.5°C dewpoint. This is clearly very significant compared to the overall accuracy of the instrument. Fortunately the user, with the benefit of the microscope, can readily diagnose the problem by reference to the diagrams below.

Bad Ice: This term refers to the nucleation at a single point on the mirror surface of a single large crystal of ice. This can form on any part of the mirror, and will usually only occur at very low dew points and when in the steady state measurement condition.

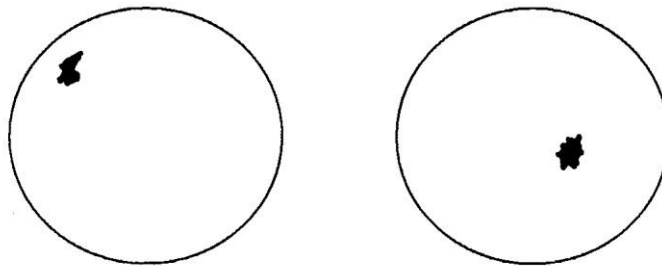

Examples of Bad Ice

Good Ice: This term refers to the nucleation of ice crystals at multiple points distributed across the mirror surface and results in a uniform and even formation of ice crystals over the entire surface of the mirror.

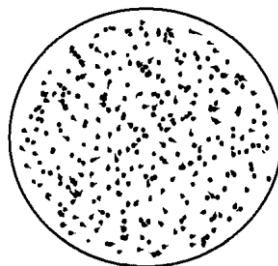

Example of Good Ice

As previously mentioned, the formation of Bad Ice in the steady state measurement condition will lead to an inaccurate measurement. If Bad Ice is observed the following simple technique can be used to force the re-nucleation of the ice formation on the mirror surface and will ensure that a Good Ice condition is guaranteed.

- 1) Press the “Max Cool” button for 1 to 2 minutes.
- 2) Release the button and as the displayed dewpoint temperature is seen to begin to rise momentarily depress (or pulse) for short periods the “Max Cool” button. While doing this, take care to ensure that the displayed dewpoint temperature does not exceed a value more than 1 to 2 degrees below that of the original steady state Bad Ice condition.
- 3) The user should continue step 2) until such time that the single large ice crystal is seen to have cleared from the mirror surface.
- 4) Allow the instrument to re-stabilise and verify by observation that a Good Ice formation is present on the mirror surface.

5 TECHNICAL SPECIFICATIONS

5.1 General

Accuracy - complete system, nominal	:	+/- 0.1 °C. dew point - displayed. +/- 1.0 % rh - displayed.
Cooling rate	:	0.5 °C. / second (average).
Response speed	:	Approx. 1 minute above 0 °C dew point and 1 hour at <-60 °C dew point. Variable between these limits.
Sensitivity	:	0.01 °C.
Repeatability	:	0.1 °C. dew point.
Power supply	:	220 to 240 Volts AC 50 / 60 Hz. OR 100 to 115 Volts AC 50 / 60 Hz. (Factory Set).
Power consumption	:	Max. 250 VA. (S4000 and S4000 Climatic) Max. 800 VA. (S4000 RS) Max. 1600 VA. (S4000 TRS)
Power Fuses	:	3.15Amp 250V 20mm Time delay (S4000 Monitor). 5 Amp 250 V 20mm Std. Blow (RS Sensor). 5 Amp 250 V 20mm Std. Blow (TRS Sensor). 10 Amp 250 V 20mm Std. Blow (TRS Sensor 100/115 V).
Heat Pump Fuse (Monitor)	:	3.15 Amp 250 V 20mm Time delay.

5.2 Sensor Unit

Mirror cooling	:	Three stage Peltier.
Mirror	:	Plated copper.
Dew-point range (with auxiliary cooling or heating on S4000 and S4000 Climatic)	:	-80 to +20 °Cdp. (S4000 Remote). -80 to +85 °Cdp. (S4000 Climatic). -85 to +20 °Cdp. (S4000 RS). -100 to +20 °Cdp. (S4000 TRS).
Gas Temperature range	:	-80 to +80 °C.
% Relative Humidity range	:	< 0.5 to 99.9 %.
Photo detection system	:	Wide band red L.E.D. and dual photo-detectors. All protected from the gas by quartz light guides.
Temperature Measurement	:	1/10 DIN 4-wire PRT. May be connected to an external 4-wire resistance bridge.
Sample flow rate	:	0.1 to 0.7 L/min. Integral 0-1 L/min flow meter.
Pressure Weight	:	Maximum 10 psig S4000 Sensor 6.4 kg (14.1 lb).

	S4000 Climatic Sensor	5.5 kg (12.1 lb).
	S4000 RS Sensor	31.5 kg (69.5 lb).
Dimensions :-		
S4000 Sensor	:	268mm(W) x 300mm Clear (D) x 133mm (H). Refer to Appendix 1b.
S4000 Climatic Sensor	:	268mm(W) x 300mm Clear (D) x 133mm (H). Refer to Appendix 1b.
S4000 RS Sensor	:	481mm(W) x 504mm Clear (D) x 402mm (H).

5.3 Monitor Unit

Digital display	:	Dual 6 digit 7-segment L.E.D., with 2 digit 7-segment unit annunciators.
Units (Top)	:	°C dew point or °F dew point.
Units (Bottom)	:	ppm(v) or ppm(w) in SF ₆ or g/m ³ or g/Kg or kPa.
		Note : If a pressure transducer is not connected to the instrument, by default, atmospheric pressure is selected i.e. 101.3 kPa.
Resolution	:	0.01 °C. (Dew point and Temperature) 0.01 °F. (Dew point and Temperature) 0.01 ppm(v) or ppm(w). 0.01 g/m ³ . 0.01 g/kg. 0.1 kPa. 0.1 % rh.
Outputs	- Analogue :	10 mV / °C dew point. 4-20 mA dew point.
	- Digital :	Data Hold Balance Cycle Optics Alarm
4-20 mA Output Span (Standard Configuration)	:	-80 to 0 °C dew point. (S4000) -50 to +50 °C dew point. (S4000 Climatic) -80 to 0 °C dew point. (S4000 RS) -100 to 0 °C dew point. (S4000 TRS)
Inputs	- Digital :	Remote ABC Initiate
Serial Comms. Type	:	RS232 (RS485 Option)
Serial Comms. Data	:	Dew point (°C), Dew point (°F), Water Content ((ppm(v)), Water Content in SF ₆ (Sulphur Hexafluoride) (ppm(w)), Water Content (g/m ³), Water Content (g/kg), Pressure (kPa), Relative Humidity (% rh), Temperature (°C), Temperature (°F), and ABC Initiate.

% rh Calculation	:	Calculated using water vapour pressure tables (D Sontag ITS-90). Over water for temperatures between 0 and 100 °C and over ice for temperatures between -100 and 0 °C.
Gas Temperature Accuracy	:	+/- 0.2 °C.
P.R.T. Probe Type	:	Stainless Steel, sheathed, with 2 Metre cable. 1/10 DIN 3 wire PRT.
Operating temperature	:	0 to 40 °C.
Operating environment	:	0 to 90% rh.
Dimensions (mm)	:	19" enclosure. 133H (3U) x 511D. Clear. Refer to Appendix 1a.
Weight	:	7.5 kg (16.5 lb).

5.4 S4000 TRS Enclosure

Power supply	:	220 to 240 Volts AC 50 / 60 Hz. OR 2 x 100 to 115 Volts AC 50 / 60 Hz.
Power consumption 200 / 240 V Supply	:	Max. 1600 VA. (S4000 TRS)
Power consumption 100 / 115 V Supply	:	Max. 1350 VA. (S4000 TRS Sensor) Max. 250 VA. (S4000 Monitor)
Power Fuses (Internal Monitor).	:	3.15 Amp 250 V 20mm Time delay (S4000 5 Amp 250 V 20 mm Std. Blow (TRS Sensor 200/240 V). 10 Amp 250 V 20 mm Std. Blow (TRS Sensor 100/115 V).
Power Fuse (External)	:	10 Amp 250V 20 mm Std. Blow (TRS Enclosure 200/240 V Only).
		Note : 100/115 V TRS Enclosure fitted with two mains supply sockets, direct to internal fused inlets as above.
Weight	:	S4000 TRS Enclosure 85.0 kg (187.4 lb).
Dimensions	:	560mm(W) x 600mm(D) x 860mm (H) Refer to Appendix 1e.

6 MAINTENANCE

6.1 Cleaning the Optical System

The Michell Series 4000 Remote is a precision optical dew-point hygrometer, which uses a four component optical system to detect condensation of water from a gas (air) sample. This system comprises a light emitting diode (L.E.D.), two photo-detectors and a mirror surface. The L.E.D. and scattered light photo-detector are isolated from the gas stream by light guides so only the ends of the light guides inside the measurement chamber and the mirror surface require cleaning. The reflected light detector receives light through a 0.8mm hole in the chamber housing and should not normally require attention.

When in the AUTO MODE, the Series 4000 instrument activates an Automatic Balance Compensation (ABC) on a regular basis to compensate for contamination of these optical components. However, this ABC system, or the manual balance system, has a finite limit of effectiveness beyond which compensation cannot be ensured. When this limit is reached the red ABC STATUS L.E.D. on the monitor front panel will light, warning of heavy contamination. At this point it is necessary to clean not only the mirror surface but also the light guide ends.

6.1.1 Cleaning Procedure

- (a) Ensure that all surfaces are at a temperature above that of the freezing point of the cleaning fluid.
- (b) Remove the metal sensor sealing cap assembly at the front of the sensor unit (including black plastic plug or microscope) by unscrewing it in an anti-clockwise direction. Take care not to misplace the "o" ring seal which seats in the p.t.f.e. block and seals against the quartz glass viewing window.
- (c) Check the "o" ring seal for damage and replace if necessary.
- (d) As a general rule, clean the mirror and light guide ends with a cotton wool bud ("Q" Tips) soaked in distilled water.

If the contamination is oil based then either isopropyl alcohol or methanol may be used instead of distilled water.

WARNING: Do **NOT** use '**ACETONE**' for cleaning; it may damage the instrument.

A spray may be used along with a cotton wool bud as long as it does not leave a film coating on the optics and providing it contains only the recommended solvent as above. Take care not to leave deposits on any of the optical surfaces.

- (e) Ensure that all the cleaning fluid has evaporated before replacing the metal sensor sealing cap assembly. Take care to ensure that the "o" ring seal is correctly seated.
- (f) After assembly, check the AUTO / MANUAL switch is in the MANUAL position and press the INITIATE push-button to initiate an ABC cycle. Then re-balance the instrument.

In a clean environment it is quite normal for the instrument to operate satisfactorily for several months without the need for optics cleaning. However, it is good practice to ensure the cleaning procedure is carried out regularly rather than waiting for the red ABC STATUS L.E.D. to illuminate.

6.2 Refrigeration Unit

The system is totally self contained and should require no regular maintenance other than cleaning away the dust collected between the fins of the condenser which is visible in the lower front half of the unit behind vented panels.

If in the event a set temperature has not been reached, then it is a possibility that there could have been a loss of refrigerant gas. Contact Michell Instruments' Technical Sales Department or your local representative for further advice.

7 OPTIONS

7.1 RS485 Output - Option

With RS485, the request commands and responses are identical to those stated in Section 4.5.2.

The 9 pin "D" type socket connector on the monitor unit rear panel marked "RS 485" has the following pin connections :

Pin Number	Function
1	N/C
2	B
3	A
4	N/C
5	Signal Ground (GND)
6	N/C
7	N/C
8	N/C
9	N/C

The serial link has the following protocol:-

9600 baud rate
 8 data bits
 1 stop bit
 No parity.

7.2 Microscope

As discussed in Section 4.8. a microscope may be used to check the formation of ice crystals between 0 and -20°Cdp . The microscope screws into the sensor assembly on the front of the S4000 Remote Dewpointmeter in place of the black blanking plug.

7.3 Remote Pressure Transducer

The standard S4000 Remote Dewpointmeter is configured such that all pressure sensitive parameters are calculated at 101.3 kPa (atmospheric pressure).

As an option, the instrument can be supplied with a pressure transducer to allow the actual sample gas pressure to be monitored, and the ppm(v), ppm(w), g/m^3 and g/kg parameters to be pressure compensated.

The standard pressure range is 0 to 50 p.s.i. absolute, i.e. at / around atmospheric pressure. But particular pressure ranges may be supplied to order. Contact "Michell Instruments" Technical Sales Department for further information.

APPENDIX 1 S4000 Remote Outline Drawings

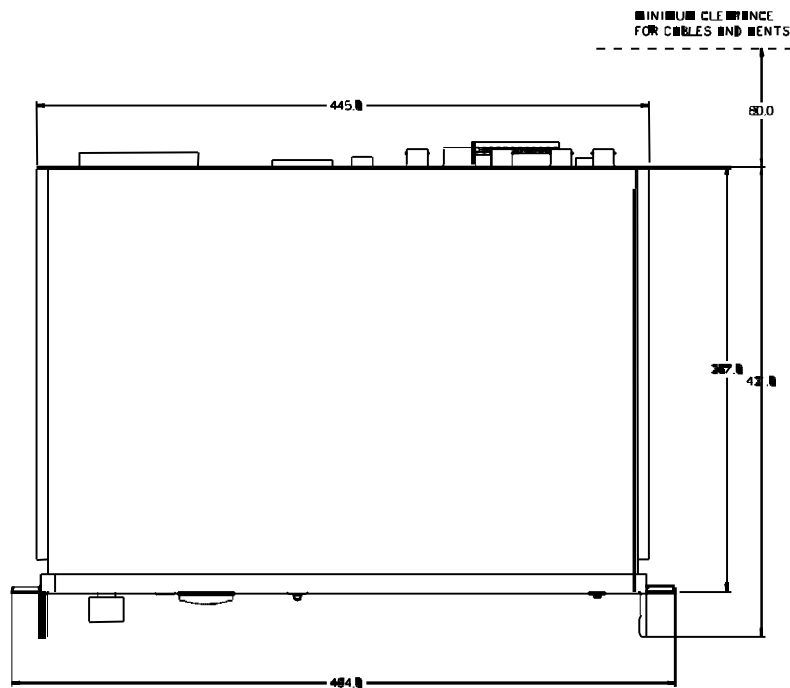
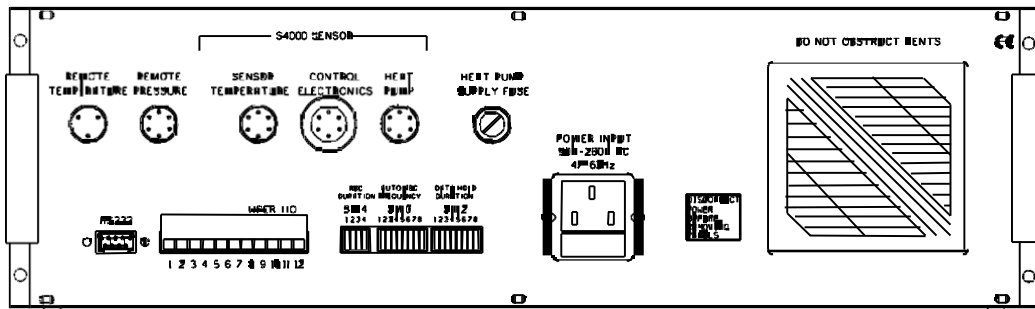
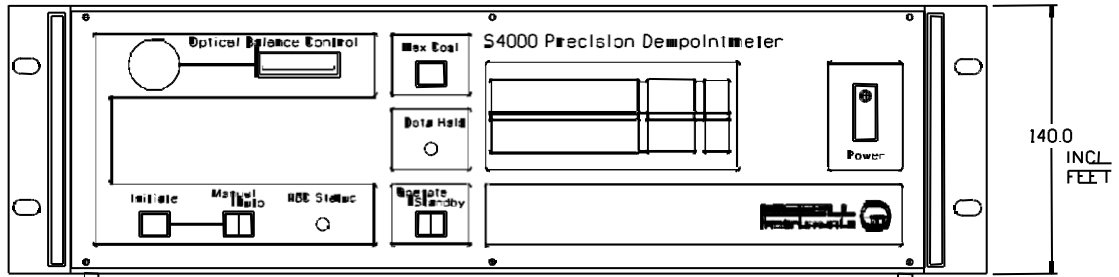

(a) S4000 Remote Monitor Outline Drawing

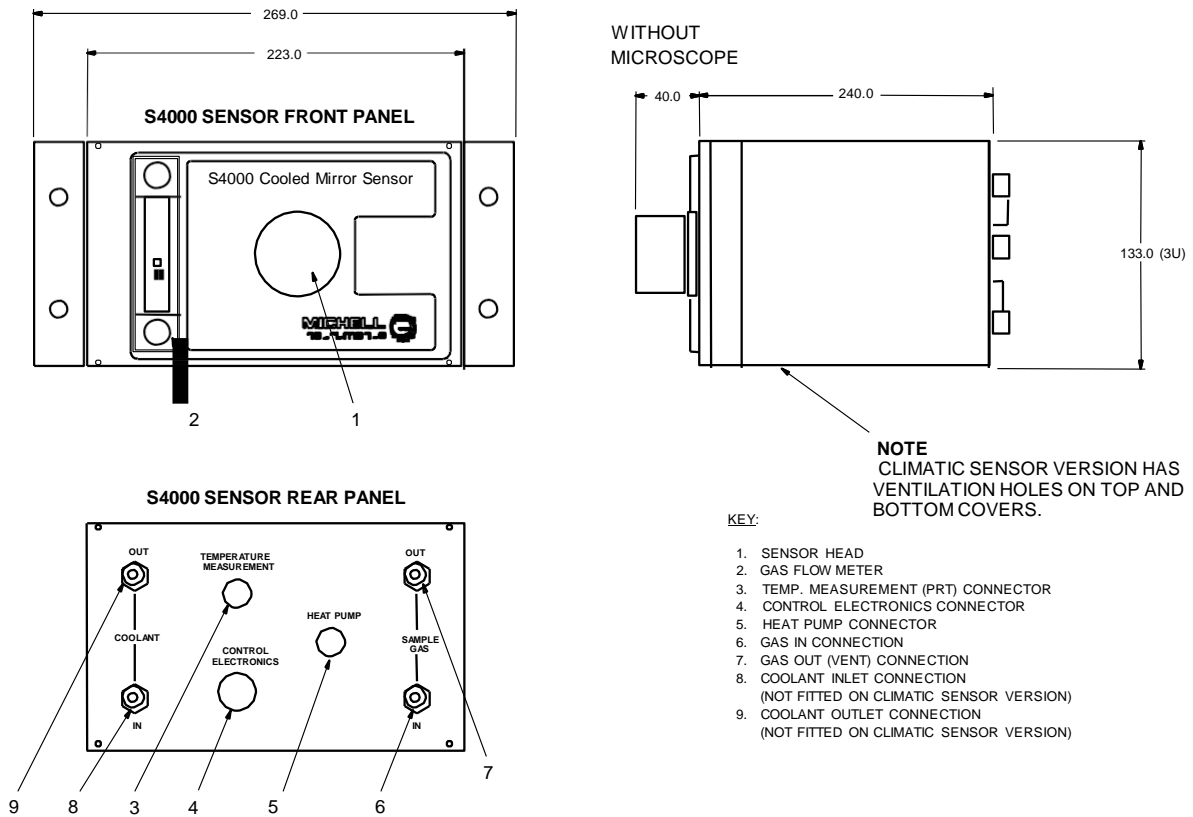

(b) S4000 Remote Outline Drawing

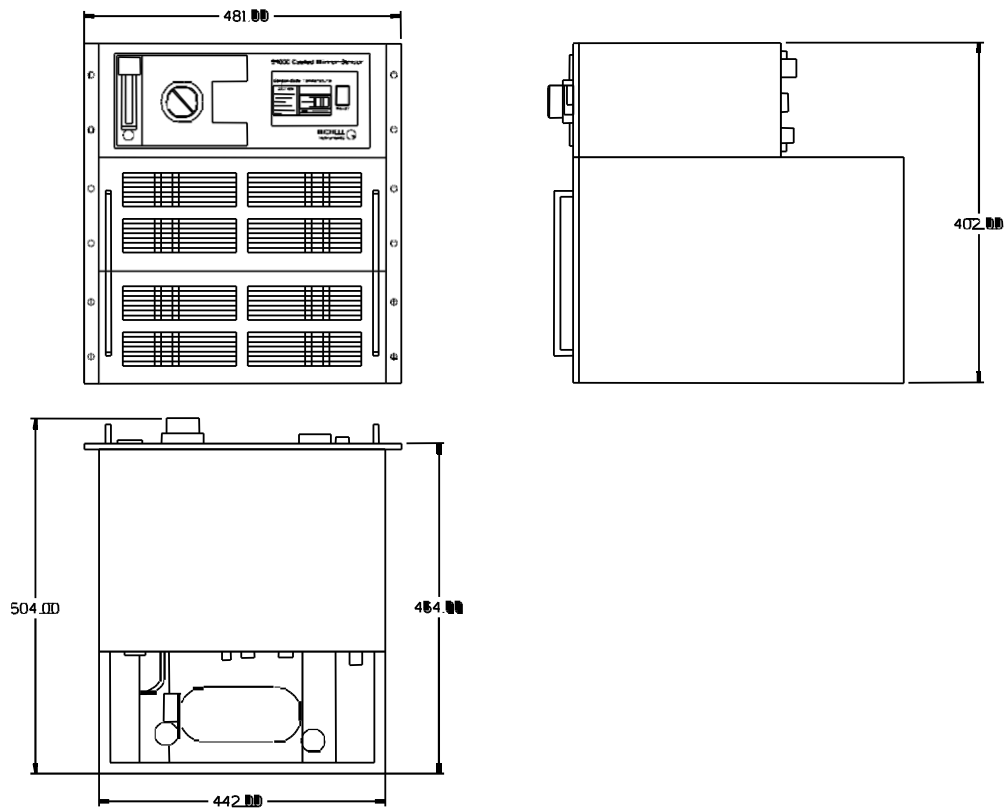

(c) S4000 RS Enclosure Outline Drawing

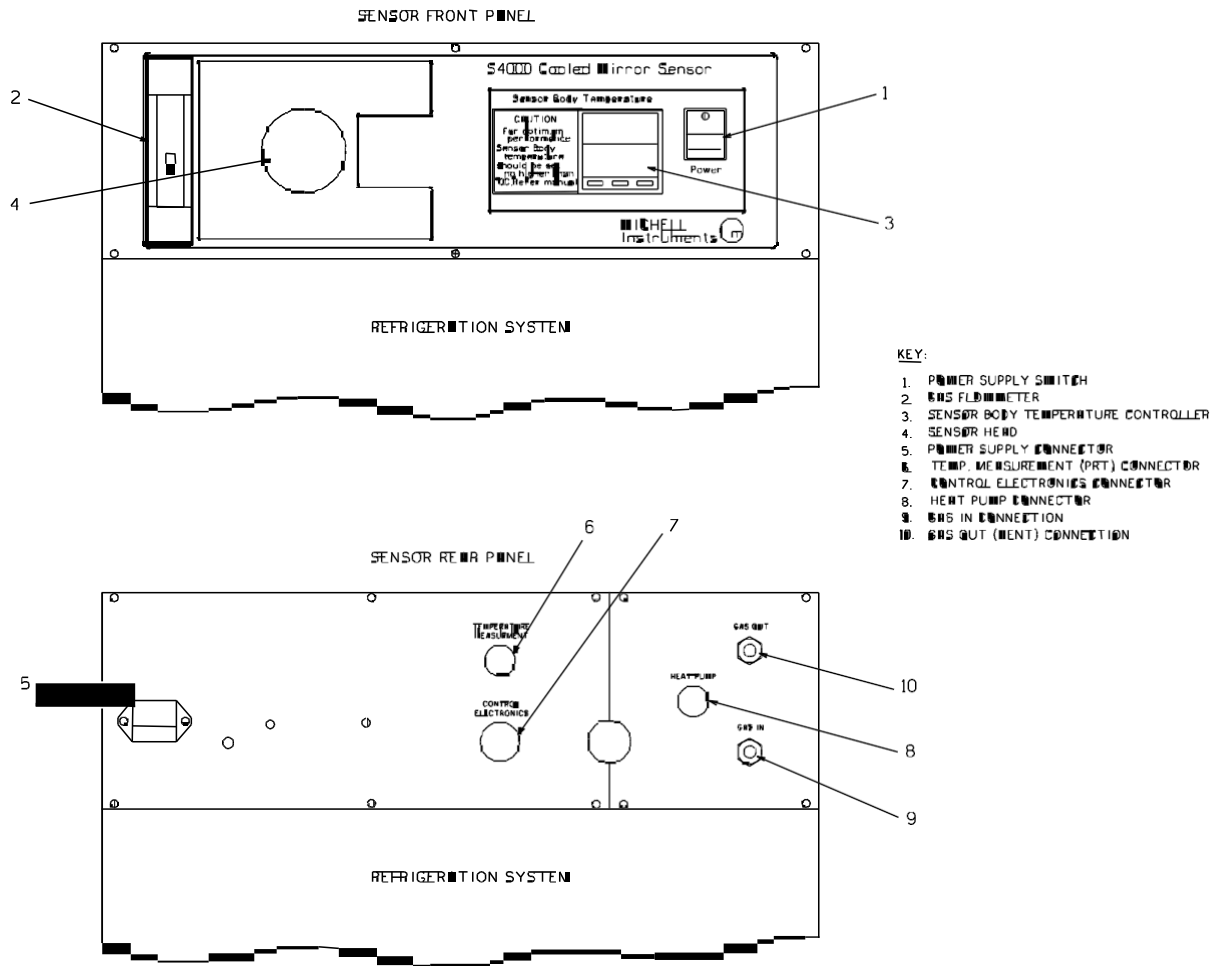

(d) S4000 RS Functional Drawing

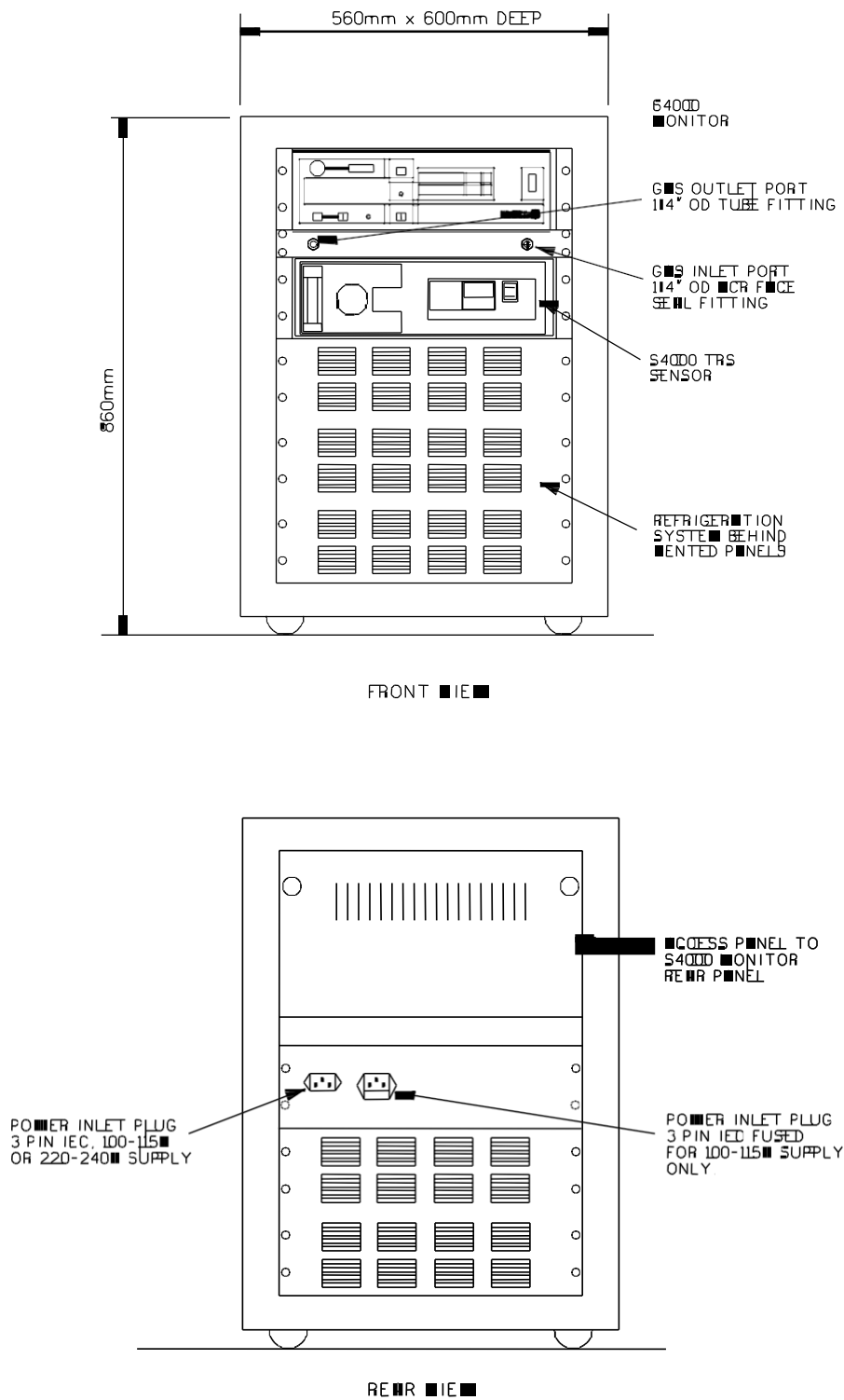

(e) S4000 TRS Enclosure Outline Drawing

APPENDIX 2 System Schematic

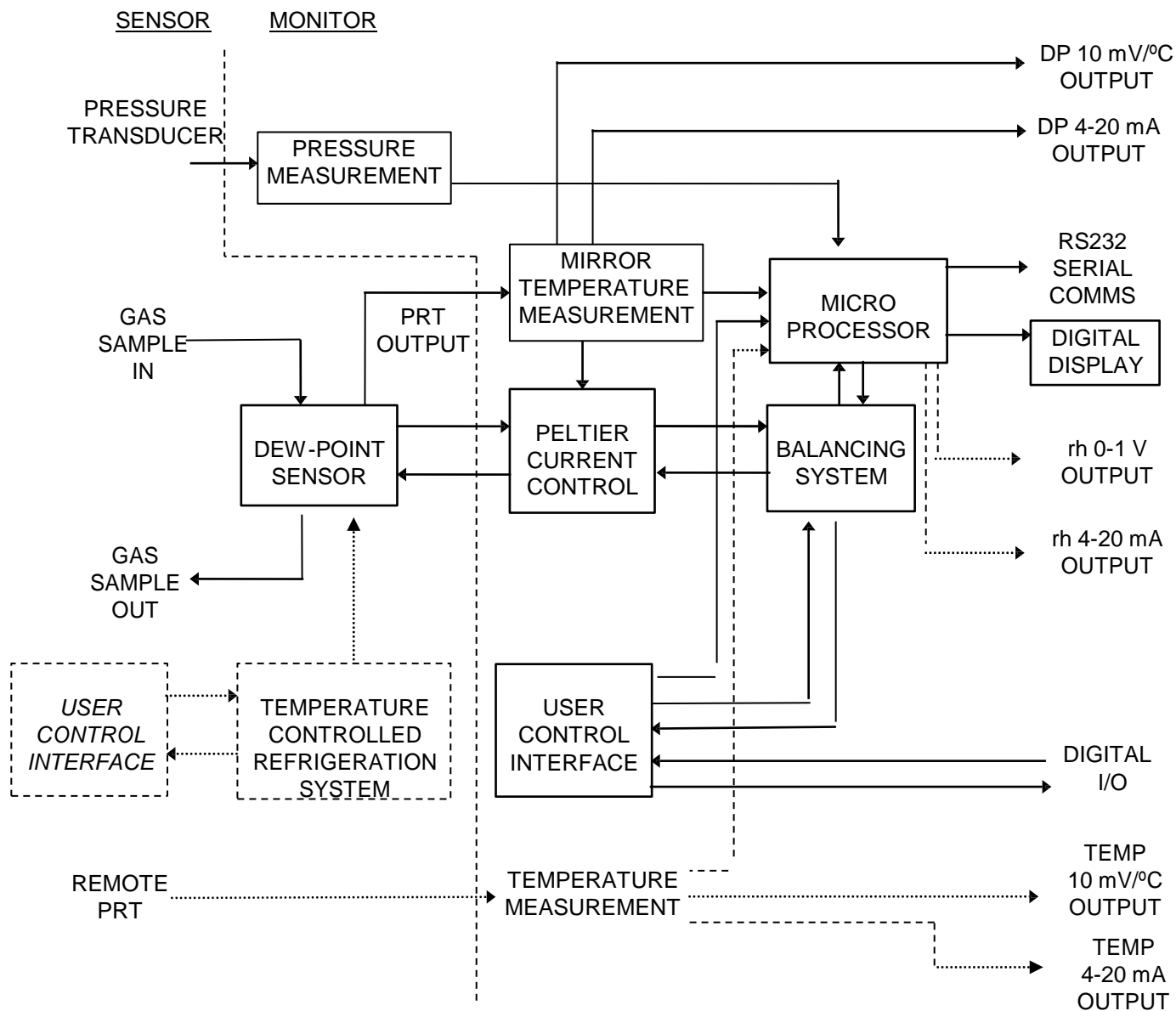

APPENDIX 3 S4000 Remote Depression Range

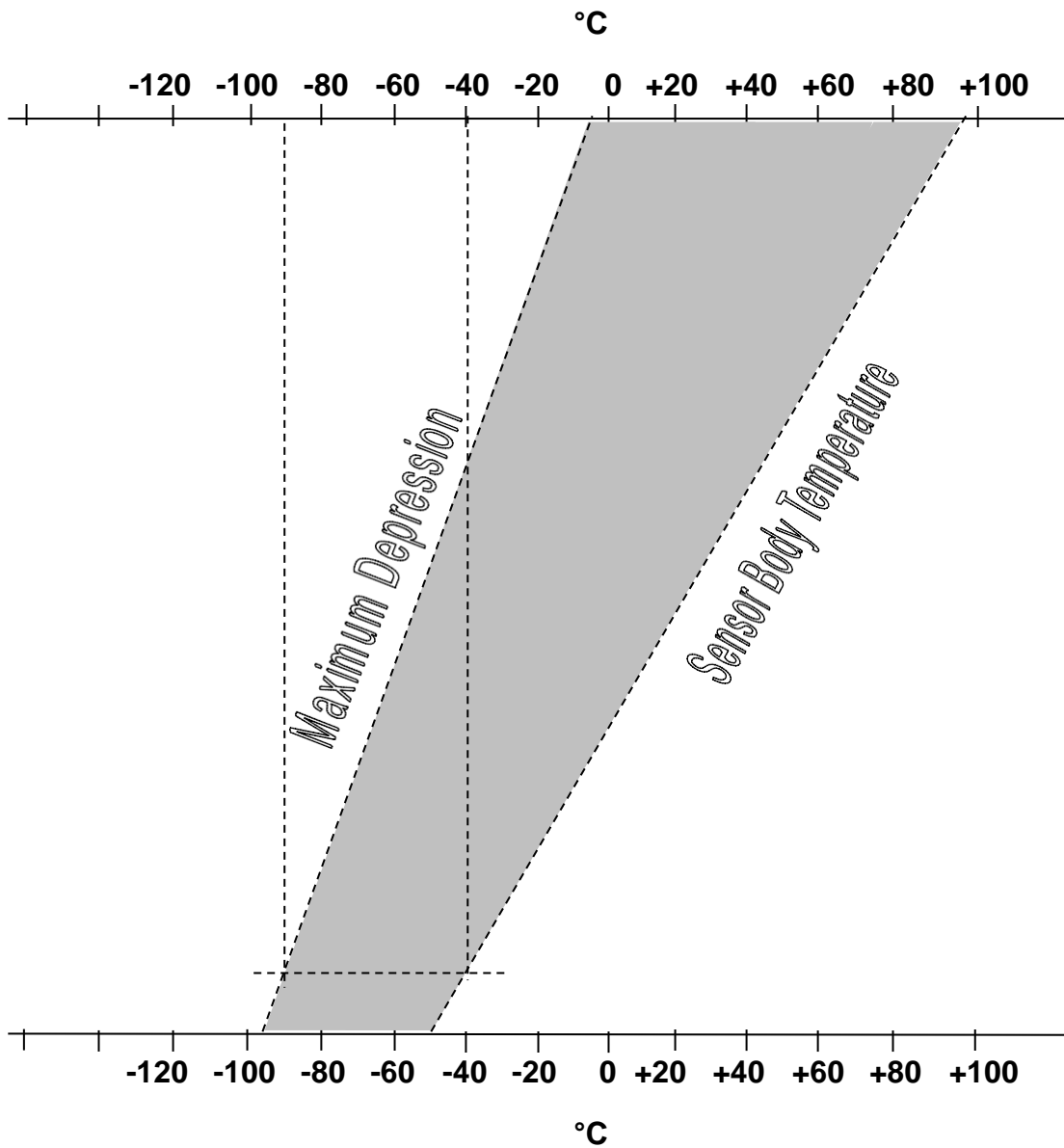

As shown, with the S4000 Remote Dewpointmeter configured for a sensor body temperature of -40 °C, the maximum depression is -90 °C.

APPENDIX 4 Hazardous Products

The Consumer Protection Act 1987, Section 6.0 of the Health and Safety at Work Act 1974 and the Control of Substances Hazardous to Health Regulations 1988, require that we advise the recipients and users of our products of any potential hazards associated with their storage, handling or use.

As the product detailed in this instruction manual contains a large number of components, both metallic and non-metallic, it is not practicable to issue full details of either all their constituents, substances or of the circumstances in which any of them may become hazardous.

We can, however, state that the product detailed in this manual and all of our other products are not hazardous to health when stored and used within the technical and environmental limitations specified in our relevant catalogue or specification sheet. Should you require any further specific information regarding individual components of this product, please contact our Technical Sales Department.

APPENDIX 5 Recycling



Michell Instruments Limited is concerned with the protection of the environment. It is our commitment to reduce and eliminate from our operations, wherever possible, the use of substances which may be harmful to the environment. Similarly, we are increasingly using recyclable and/or recycled material in our business and products wherever it is practical to do so. The product you have purchased may contain recyclable and/or recycled parts and we will be happy to provide you with information on these components should you desire it.

APPENDIX 6 WEEE & RoHS

The Waste Electronic and Electrical Equipment (WEEE) Directive, and the Restriction of Hazardous Substances (RoHS) Directive place new rules upon European manufacturers of electrical and electronic equipment. The Directives aim to reduce the impact that electronic devices have on the environment.

Michell Instruments are aware of the WEEE and RoHS Directives, and have investigated their requirements. Michell products are currently exempt from the RoHS Directive, however all future products will be developed entirely using compliant materials. Furthermore, Michell is taking active steps to remove non-compliant materials and components from existing products wherever possible.

Michell is also progressing towards full compliance with the WEEE Directive. In the short term this will result in additions to product labelling, though in the long term customers may be required to return certain instruments for treatment at the end of their working life.

June 2006

APPENDIX 7 Liability

Although Michell Instruments Ltd. is committed to supplying its customers a good quality, well tested product, we reserve the right to make modifications to the product described in this document. The information contained in this document has been checked and is believed to be factually correct. However, Michell Instruments Ltd. assumes no responsibility for any mistakes, omissions or inaccuracies.

APPENDIX 8 Customer Service Contact Details

For advice on this, or any other Michell Instruments product, please feel free to contact us via our Web Site: www.michell.com