

UNIBLITZ

AIC10 Auto Iris Controller

User Manual



Please read this manual before operating the device, and keep it for future reference.

Safety Concerns

Review the following safety precautions to avoid injury and prevent damage to this product or any products connected to it. To avoid potential hazards, use the product only as specified. Only qualified personnel should perform service procedures.



Caution Statements: Identify conditions or practices that could result in injury, loss of life, or damage to this product or other property. They will be shown with this symbol (left) throughout this manual.

Injury Precautions

1. Use proper power supply and line cord (Included) – To avoid fire hazard, use only correct power and cord as specified elsewhere in this manual. Model PS12 power supply and line cord are provided.
2. Avoid electric overload – To avoid electrical shock or fire hazard, do not apply a voltage to a terminal that is outside the range specified for that terminal.
3. Avoid electric shock – To avoid injury or loss of life, do not connect or disconnect line cord (of power supply) while it is connected to the line voltage.
4. Ground the product – This product is grounded through the AIC10 DC input. Before making connections to the input or output terminals of the product, ensure that the product is properly grounded. **DO NOT DEFEAT THE GROUND CONNECTION OF THE INCLUDED POWER SUPPLY.**
5. Access to On/Off Switch – Do not position the unit such that it is difficult to operate the on/off switch.
6. Do not operate in wet/damp conditions – To avoid electric shock, do not operate this product in wet or damp conditions.
7. Do not operate in explosive atmosphere – To avoid injury or fire hazard, do not operate this product in an explosive atmosphere.

Product Damage Precautions

8. Use proper power source – Do not operate this product from a power source that applies more than the voltage specified.
9. Provide Proper Ventilation – To prevent product overheating, provide proper ventilation.
10. Do not operate with suspected failures – If you suspect there is damage to this product, have it inspected by qualified service personnel.

Table of Contents

1.0 - Getting Started / 1

- 1.1 - What's in the Box / 2
- 1.2 - Product Overview / 3
- 1.3 - Initial Setup Procedure / 4

2.0 - Operating the AIC10 / 6

- 2.1 - Navigating the Menus / 7
- 2.2 - Calibrating the Iris / 8
- 2.3 - Adjusting the Aperture's Position / 9
- 2.4 - Saving Aperture Postions / 11
- 2.5 - Fully Closing/Opening the Aperture / 12

3.0 - External Iris Control with the AIC10 / 13

- 3.1 - Choosing Between Ext. Control Inputs / 14
- 3.2 - External Control Input: TTL / 14
- 3.3 - External Control Input: USB / 16

4.0 - Operating the Shutter Attachment / 18

- 4.1 - Complete Closure using "Auto Close" / 19
- 4.2 - Shutter State on Power Up / 20
- 4.3 - Operating the Shutter Externally / 20
 - 4.3.1 - External Shutter Control: TTL / 21
 - 4.3.2 - External Shutter Control: USB / 21

5.0 - Specifications / 23

- 5.1 - System Characteristics / 24
- 5.2 - External Input Characteristics / 25
- 5.3 - External Output Characteristics / 28
- 5.4 - General Characteristics / 28

6.0 - Warranty / 30

7.0 - Declaration of Conformity / 32

Are you viewing this manual electronically?

If so, click or press the page links throughout the table of contents to quickly be sent to that page.

Section 1.0

Getting Started

Welcome to your new Uniblitz AIC10 Auto Iris Controller: A controller specifically designed for use with the Uniblitz AI25 Auto Iris.

The AIC10's intuitive front button panel and display make getting started simple and easy. This section will outline what's included with the AIC10, will provide a quick product overview, and will walk you through a simple setup procedure.



These steps require the AI25 Auto Iris.

This manual assumes you are using the AIC10 with the Uniblitz AI25 Auto Iris.

What's in the Box

What's Included

- AIC10 Iris Controller
- Manual (included on flash drive)
- 10C3 iris/shutter interconnect cable (3.0 m) - For interfacing AIC10 with iris/shutter
- USB-AB Cable (1.0 m) - For interfacing with computer
- PS12 Power Supply w/ US & Euro line cords
- AIC10 Quick Reference Guide



Product Overview



Fig. 3

- | | | |
|-----------------------------|-------------------------------|---------------------------------------|
| 1 Power LED | 11 Iris Input Mode Toggle | 20 Shutter State (N.C. / N.O.) |
| 2 Shutter / Sync Active LED | 12 TTL / USB Toggle | 21 External Control Input (TTL / USB) |
| 3 Display (Backlit LCD) | 13 Decrease Step / Menu Down | 22 TTL Control Mode (INC / TOG) |
| 4 Shutter (Activate) | 14 Calibrate Iris | |
| 5 Iris - Full Open | 15 Back / Return | |
| 6 Iris - Full Close | 16 Set/Saved Position 2 | |
| 7 Increase Step / Menu Up | 17 Aperture Size | |
| 8 Select / Accept | 18 Resolution (FINE / COARSE) | |
| 9 Menu | 19 Auto Close (ON / OFF) | |
| 10 Set/Saved Position 1 | | |

AIC10 Rear Panel

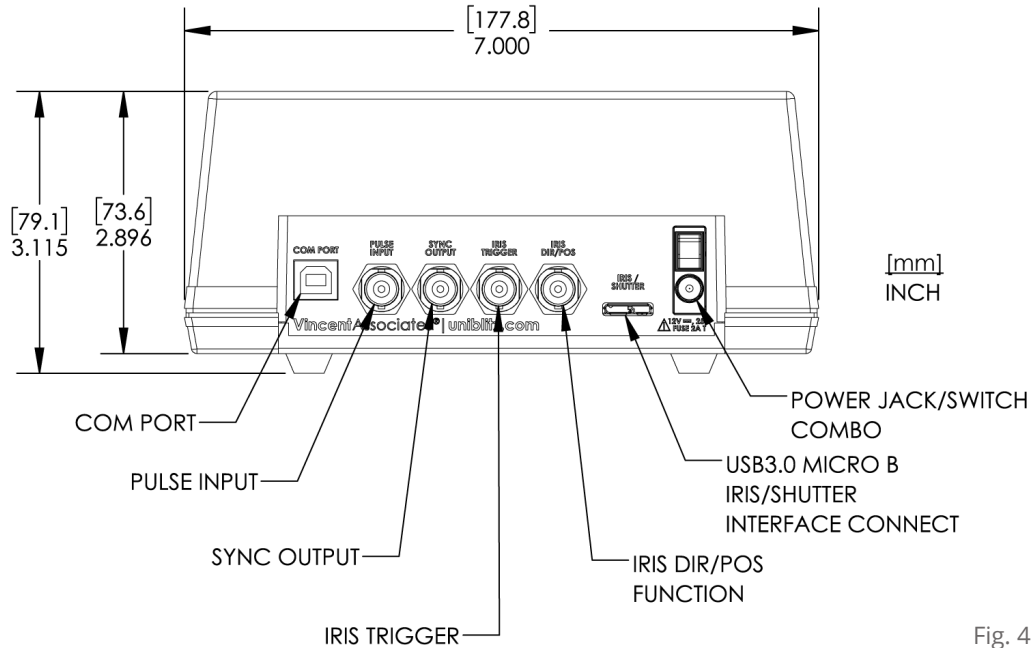

Fig. 4

Section 1.3

Initial Setup Procedure



Fig. 5

These steps will walk you through the initial setup of the AIC10 controller:

1. After unpacking your AIC10 unit, inspect the device for any defects and the package for any missing parts. If upon inspection a problem is found or a part(s) is missing, **contact us** immediately. A checklist is included for a quick inventory of included parts and accessories.
2. Assemble the included PS12 12V Power Supply by connecting the power adapter to the AC line cord. Both "Type B" and "Type E" AC line cords are included with the AIC10, so be sure to connect whichever AC line cord is compatible with a standard outlet in your region.



CAUTION: Be sure the AIC10 rear panel power switch is in the “OFF” position, that is with the power switch’s “O” icon in the depressed position, **before inserting an included AC line cord** into a standard outlet.

3. Be sure the AIC10 rear panel power switch is in the “OFF” position, and insert the DC power jack of the included PS12 12V Power Supply into the power port located on the AIC10 rear panel. Then plug the AC line cord from the PS12 Power Supply into a standard outlet (100-240 VAC, 50/60 Hz power source).
4. Locate the included 103C Iris Shutter Interconnect Cable. Connect one end of the 103C to the AI25 Auto Iris, and the other to the rear panel of the AIC10 Iris Controller (to the connector port labeled “Iris/Shutter”).
5. Power on the AIC10 Iris Controller by switching the rear panel power switch to the “ON” position (|) (Fig. 6). The AIC10’s green “POWER” LED will illuminate, indicating that the device is powered (Fig. 5). The front-panel display will illuminate as well, and will show the Iris Status Screen (Fig. 7). If your AI25 is equipped with the high-speed shutter attachment, the shutter will automatically close upon power up and the amber “SHUTTER SYNC ACTIVE” LED may quickly illuminate.
6. To ensure that the attached AI25 25 mm motorized iris diaphragm is fully functional and properly communicating with the AIC10, fully close the iris by pressing the “IRIS - FULL CLOSE” (●) button on the AIC10’s front panel. The AI25’s aperture should maintain an opening of approximately 1.5 mm. Next press the “IRIS - FULL OPEN” (●) button to return the iris to its fully open position. The iris blades should be completely clear of the aperture.
7. If your AI25 is equipped with the optional shutter attachment, open the shutter by pressing the blue “SHUTTER” (●) button on the AIC10’s top panel. The amber “SHUTTER SYNC ACTIVE” LED should turn off while the shutter is in the closed position. Press the “SHUTTER” (●) button again to close the shutter.
8. Should the AIC10, AI25, or optional shutter attachment not respond as described in steps 6 and 7, be sure that all connections from the power supply are made properly. [Contact us](#) if problems persist.

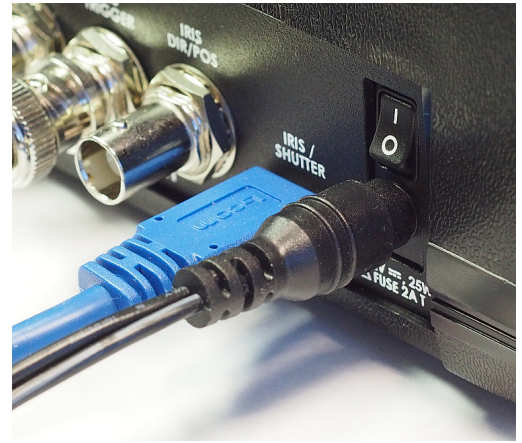

Fig. 6

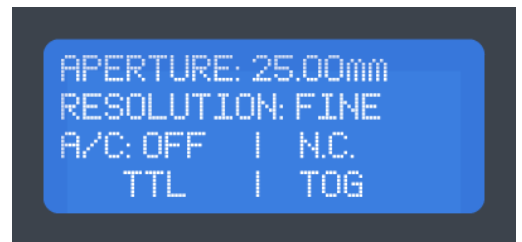

Fig. 7



CAUTION: When turning off your AIC10 Iris Controller, be sure the AIC10 rear panel power switch is in the “OFF” position, that is with the power switch’s “O” icon in the depressed position, before removing the AC line cord from the outlet.



BE ADVISED: All fuses are internal to the unit. If you believe that a fuse has blown, [contact us](#) for further instruction.

Section 2.0

Operating the AIC10

With your AIC10 set up and ready to use, let's now walk through each function, feature, and setting of the controller to get a clear understanding of its operation.



These steps require the AI25 Auto Iris.

This manual assumes you are using the AIC10 with the Uniblitz AI25 Auto Iris.

Navigating the Menus

The AIC10 features an interactive digital display that allows users to navigate through and set the various functions and features of the device. There are five (5) buttons on the AIC10 Front Panel that allow for the navigation and selection of menu items:

“MENU” (☰), “SELECT / ACCEPT” (✓), “INCREASE STEP / MENU UP” (▲), “DECREASE STEP / MENU DOWN” (▼), and “BACK / RETURN” (↵).

Certain buttons have multiple functions depending on which menu or screen you are on. For example, when on the Iris Status Screen, the “INCREASE STEP / MENU UP” (▲) button will increment the iris position upward by a given number of steps. While viewing a menu screen, this same button will allow you to navigate through the menu items upwards. Similarly, the “DECREASE STEP / MENU DOWN” (▼) button will change the iris position on Iris Status Screen, and navigate through menu items on a menu screen.

As an exercise, let’s navigate the menus to change the resolution of the AI25 auto iris from “FINE” to “COARSE.”

1. If not already on the Iris Status Screen, press the “BACK / RETURN” (↵) button to return to it (it may need to be pressed multiple times if you are within a submenu (Fig. 8).
2. Press the “MENU” (☰) button.
3. Press the “DECREASE STEP / MENU DOWN” (▼) button once to navigate to the “2. SET RESOLUTION” setting submenu (Fig. 9).
4. Press the “SELECT / ACCEPT” (✓) button to choose this setting and enter its submenu.
5. Press the “DECREASE STEP / MENU DOWN” (▼) button once to navigate to

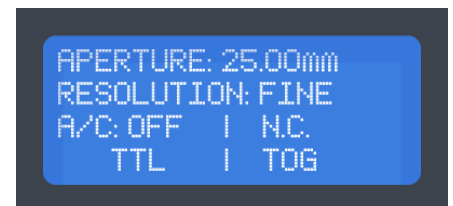

Fig. 8

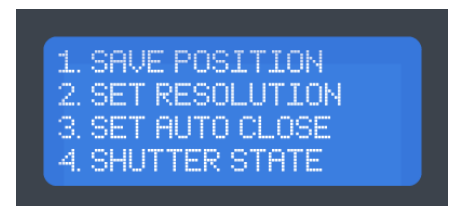

Fig. 9

the “COARSE” setting (Fig. 10).



6. Press the “SELECT / ACCEPT” () button to choose this setting.
7. Press the “DECREASE STEP / MENU DOWN” () button a few times, noting that while on the Iris Status Screen, this button now adjusts the aperture of the iris. Similarly, you can press the “INCREASE STEP / MENU UP” () button to open the iris.



Fig. 10

The “COARSE” resolution setting has now been selected and will appear on the Iris Status Screen, which you will be automatically returned to after changing this setting (Fig. 11). The remainder of this manual assumes you are using the “FINE” resolution setting.

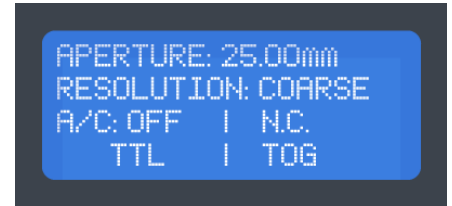



Fig. 11

Section 2.2

Calibrating the Iris

The AI25 operates as an “open loop” motion control system, meaning there is no direct feedback from the motor that indicates what position the blades are in (there is no position encoder). With this in mind, the AIC10 iris controller includes a calibration feature that allows for the AI25 to correct any potential positional issues that could ultimately effect the device’s precision.

To calibrate the iris using the AIC10 controller:

1. Ensure that the AIC10 controller is on the Iris Status Screen.
2. Press the “IRIS FULL CLOSE” () button once to bring the iris blades to the minimum aperture position.*



3. Press the "CALIBRATE IRIS" () button once to calibrate the iris blades.

* Iris calibration can be initiated from any position the iris is in. If the iris is in the fully open position when a calibration command is provided, the iris will calibrate, however movement in the iris may not occur or be noticeable.

The iris will have successfully calibrated once the iris blades have moved to the full open position and then back to the original position.

Section 2.3

Adjusting the Aperture's Position

The AIC10 can control the iris position using the "INCREASE STEP / MENU UP" () and "DECREASE STEP / MENU DOWN" () buttons while on the Iris Status Screen. The size of the aperture is indicated on the this screen (Fig. 12).

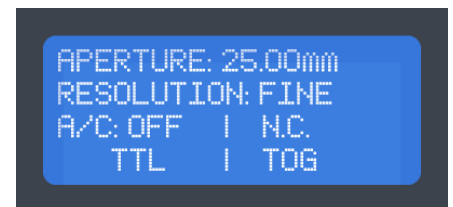









Fig. 12

1. Ensure that the AIC10 is on the Iris Status Screen.
2. Press the "IRIS FULL OPEN" () button once to bring the iris blades to the fully open position.
3. Press the "DECREASE STEP / MENU DOWN" () button once and the iris will move one increment (the iris will move one increment per depression of the button). Continue pressing this button until the iris has reached its minimum aperture (in which case the blades will no longer respond to this button).
4. From the minimum aperture position, press the "INCREASE STEP / MENU UP" () button to then increase the size of the iris aperture.

Additionally, particular aperture positions can be quickly selected:

1. Ensure that the AIC10 is on the Iris Status Screen, and then press the "SELECT / ACCEPT" () button once (Fig. 13).
2. Use the "INCREASE STEP / MENU UP" () and "DECREASE STEP / MENU DOWN" () buttons to choose the desired aperture position.
3. Press the "SELECT / ACCEPT" () button once to adjust the iris.

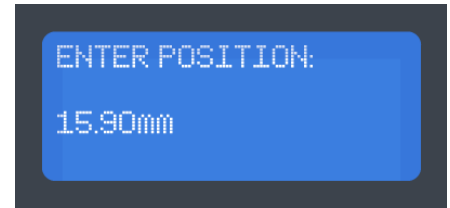



Fig. 13

The AIC10 can adjust the iris position using both a "COARSE" resolution mode and "FINE" resolution mode. In "COARSE" mode, each press of the "INCREASE STEP / MENU UP" () and "DECREASE STEP / MENU DOWN" () buttons will increment the iris five (5) times (an increment in "COARSE" mode is approximately 2.3 mm compared to 0.5 mm while in "FINE" mode).

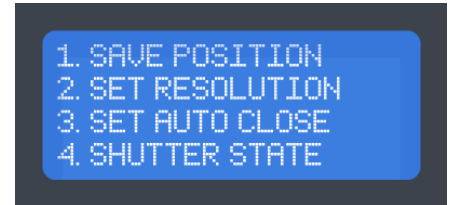

Fig. 14

To switch to the "COARSE" resolution mode:





1. Ensure that the AIC10 is on the Iris Status Screen.
2. Press the "MENU" () button.
3. Press the "DECREASE STEP / MENU DOWN" () button once to navigate to the "2. SET RESOLUTION" setting submenu (Fig. 14).
4. Press the "SELECT / ACCEPT" () button to choose this setting and enter its submenu.
5. Press the "DECREASE STEP / MENU DOWN" () button once to navigate to the "COARSE" setting (Fig. 15).
6. Press the "SELECT / ACCEPT" () button to choose this setting.



Fig. 15

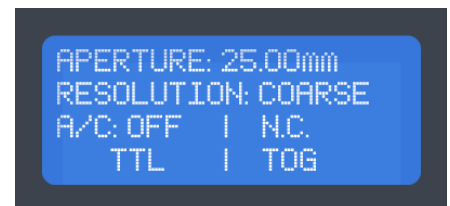







Fig. 16

The "COARSE" resolution setting has now been selected and will appear on the Iris Status Screen (Fig. 16).

Saving Aperture Positions

The AIC10 has the ability to save two (2) iris aperture positions, allowing you to quickly access a frequently required aperture size with a single press of a button.

To define a saved aperture position:

1. Ensure that the AIC10 is on the Iris Status Screen.
2. Use the "DECREASE STEP / MENU DOWN" () and "INCREASE STEP / MENU UP" () buttons to move the iris aperture to a position that you'd like to save.
3. Press the "MENU" () button.
4. Press the "SELECT / ACCEPT" () button to choose the "1. SET POSITION" menu option (Fig. 17).
5. To define the first save profile, [S1], press the "SET POSITION 1" () button once. Upon pressing this button, the first save profile will be set and you will be returned to the Iris Status Screen (Fig. 18).
6. To set the second save profile, repeat steps 1 - 4, and then press the "SET POSITION 2" () button.

You can overwrite the save profiles by simply setting a new iris aperture position for each.



Fig. 17

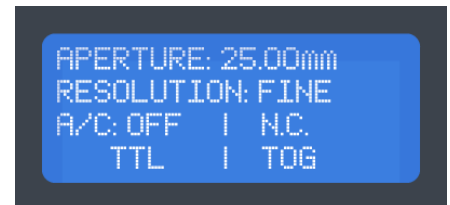



Fig. 18

Fully Opening/Closing the Aperture

The AIC10 can bring the AI25's aperture to the closed or fully open position in 0.22 seconds. *

To fully open the iris aperture:

1. Ensure that the AIC10 is on the Iris Status Screen.
 2. Press the "IRIS FULL OPEN" () button once to bring the iris blades to the fully open position.
-

To close the iris aperture:

1. Ensure that the AIC10 is on the Iris Status Screen.
2. Press the "IRIS FULL CLOSE" () button once to bring the iris blades to the fully closed position.

** Note that the iris blades themselves do not fully close, and that a 1.5 mm aperture will still remain. The optional shutter attachment allows the aperture to completely close.*

Section 3.0

External Iris Control with the AIC10

The AI25 auto iris can be controlled externally via the AIC10's external control inputs. This set of functions is useful for users seeking to operate the AI25 auto iris using a third party system.

This section will walk you through steps involved with setting up the AIC10 for external use, and will shed light on some of the controller's functions associated with external iris control.

Section 3.1

Choosing Between Ext. Control Inputs

The AIC10 can be controlled externally using both USB and TTL (via BNC) control inputs.

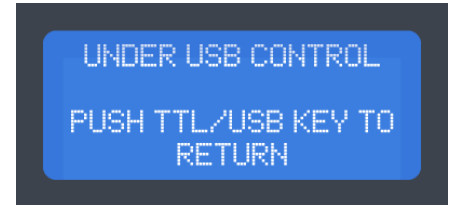



Fig. 19

To select between the TTL and USB external control inputs:

1. Press the "TTL / USB" () button once. Upon pressing this button, the display will show the Iris Status Screen if you have toggled the TTL external control input, or the screen shown in Fig. 19 if you have toggled the USB external control input.
2. If you enter USB mode, press the "TTL / USB" () button again to return to the Iris Status Screen. The iris will calibrate and return to its position prior to entering USB mode.

Section 3.2

External Control Input: TTL

The TTL external control input activates external control via the BNC connectors on the rear panel of the AIC10 (Fig. 20). The BNC connectors labeled "IRIS TRIGGER" and "IRIS DIR/POS" are used to control the iris. The additional BNC connectors are used for external shutter control. See [Section 4.3.1](#) for information regarding external *shutter* control via BNC.



Fig. 20

There are two (2) TTL iris input modes.

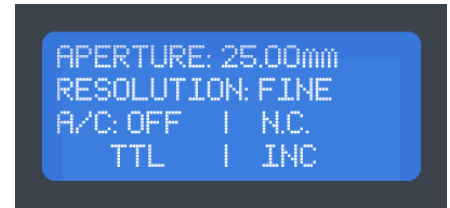





Fig. 21

To select between these TTL control modes:

1. Press the "IRIS INPUT MODE" () button once. Upon pressing this button, the Iris Status screen will indicate the TTL iris input mode that the AIC10 is in. It will read either "TOG" or "INC" (Fig. 21).

TOG - You can externally toggle between two saved aperture positions. *

Ensure that the Iris Status Screen displays "TOG" for the TTL control mode. A TTL high level (5 V) on the "IRIS DIR/POS" BNC input selects the first saved iris position (). One high pulse on the "IRIS TRIGGER" BNC (active high) input will then allow the iris to move to that first saved aperture position. Subsequent active-high pulses to this input will cause no change in the iris position.

To select the second saved iris position (), switch to a TTL low level (0 V) on the "IRIS DIR/POS" BNC input. To then move to that saved iris position, input an active-high to the "IRIS TRIGGER" BNC input.

** Saved iris aperture positions need to be set before attempting to use this TTL iris input mode (see [Section 2.4](#) to learn how to save iris aperture positions).*

INC - You can externally adjust the iris aperture position incrementally. *

Ensure that the Iris Status Screen displays "INC" for the TTL control mode. An active-high signal on the "IRIS DIR/POS" BNC input will set the iris aperture to increase by a single step, and active-high pulses on the "IRIS TRIGGER" BNC input will trigger the iris to increment. Each subsequent active-high pulse on the "IRIS TRIGGER" will continue to increment the iris aperture toward its fully open position, though the iris will stop incrementing once it reaches the fully open position.

To decrease the size of the iris aperture, switch the "IRIS DIR/POS" BNC input to a TTL low level (0 V). Active-high pulses to the "IRIS TRIGGER" BNC input will cause the iris aperture to decrease by a single step. Each subsequent active-high pulse on the "IRIS TRIGGER" will continue to increment the iris

aperture toward its fully closed position, though the iris will stop incrementing once it reaches the fully closed position. Fig. 22 indicates the signals required by the user to increment or decrement the iris.

* The COARSE or FINE resolution settings will indicate the size of the iris aperture increments. See [Section 2.3](#) to learn more about the COARSE and FINE resolution settings.

AI25 Pulse Chart

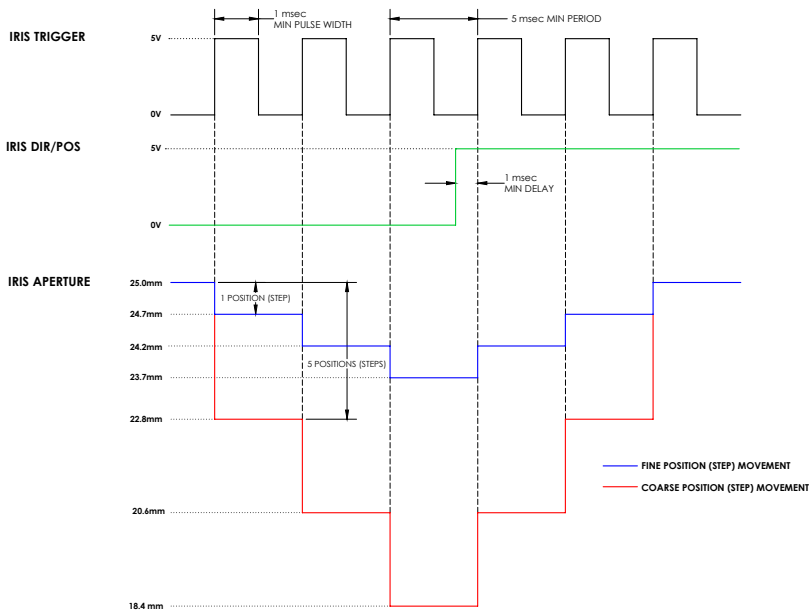



Fig. 22

Section 3.3

External Control Input: USB

The USB external control input activates external control via the USB connector on the rear panel of the AIC10, labeled "COM PORT." See [Section 4.3.2](#) for information regarding external shutter control via USB.

The USB external control input allows the AIC10 to be controlled via serial commands. While this external control input is enabled, the AIC10's keypad will be disabled, except for the "TTL / USB" () button. Additionally, the BNC connectors labeled "IRIS TRIGGER" and "IRIS DIR/POS" are disabled while this external control input is enabled.

To set up and use the USB external control input:

1. Attach the included USB-AB cable to the rear of the AIC10 (using the cable's "B" connector), and then to a USB port on a compatible computer (using the cable's "A" connector) (Fig. 23).
2. Ensure that the USB external control input is selected by pressing the "TTL / USB" () button. The USB external control input is active when you see the screen shown in Fig. 24.
3. With the USB-AB cable properly connected, a compatible computer should automatically recognize the controller. If not, the USB driver can be downloaded and manually installed: <http://ftdichip.com/Drivers/CDM/.....>
4. To test the USB external control input via a computer, use a terminal program such as Termitte, available at: http://www.compuphase.com/software_termite.htm



Fig. 23

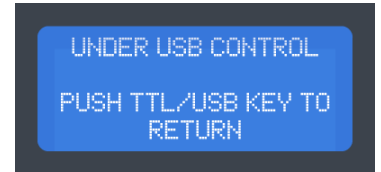

Fig. 24

USB Protocols for External Iris Control

Command	Description	ASCII
IRIS "Decrement"	Closes iris one position (step)	D
IRIS "End"	Fully closes iris	E
IRIS "Goto" ¹	Sends iris to requested position	GX1X2 ²
IRIS "Home"	Fully opens iris	H
IRIS "Increment"	Opens iris one position (step)	I
SHUTTER/IRIS "Reset"	Closes shutter, opens iris	C

² X1 and X2 are numerical positions of the iris where X1 is in the range of 0 to 5 and X2 is in the range of 0 to 9. See [page 27](#) for specific aperture sizes at a given step.



For a full list of USB control protocols, see [Section 5.2](#).

¹ IRIS "Goto"

The IRIS "Goto" command brings the iris to a specific aperture size. Its command structure, GX1X2, is made up of two additional values (X1 and X2) that are required to move the iris to one of 54 pre-set positions (which is an approximate aperture in mm, as shown on [page 27](#)). The maximum value would be the command "G54," which would bring the iris to its minimum 1.5mm aperture. Additionally, if you enter a position where the iris already is located, it will not move.

Section 4.0

Operating the Shutter Attachment

The AI25's optional shutter attachment allows for a complete closure of the AI25's iris aperture. It also provides shutter exposure control throughout the AI25's aperture range.

Specifications for the AI25's optional shutter attachment are similar to the Uniblitz DSS25B 25mm optical shutter, and can be found in [Section 5.0](#).



These steps require the AI25 Shutter Attachment.

The Shutter Attachment's Electronic Synchronization System

The AI25's optional shutter attachment includes an electronic synchronization system which "activates" when the shutter has achieved a full-open position. This will be indicated by the amber LED on the front panel of the AIC10 controller, labeled "SHUTTER SYNC ACTIVE" (Fig. 25).



Fig. 25

To open or close the optional shutter attachment manually:

1. Press the blue "SHUTTER" (●) button once to toggle the shutter's state. When the shutter has achieved a full open position, the amber LED on the front panel of the AIC10 controller (labeled SHUTTER SYNC ACTIVE) will illuminate.

Section 4.1

Complete Closure using "Auto Close"

The AI25's optional shutter attachment can automatically close when the iris blades are decremented one step beyond their minimum position of 1.5 mm. This feature allows the entire system to achieve complete aperture closure (0.0 mm). The shutter will reopen if the iris is then given an single increment command. With additional increment commands, the iris blades will open normally.

To enable the "Auto Close" feature:

1. From the Iris Status Screen, press the "MENU" (☰) button.
2. Select menu item 3, "SET AUTO CLOSE," and then select submenu item 2, "ON."

Section 4.2

Shutter State on Power Up

Upon powering up the AIC10, the shutter attachment can be preset to automatically open or remain closed.

To choose the default shutter state at system power up:

1. From the Iris Status Screen, press the "MENU" () button.
2. Select menu item 4, "SHUTTER STATE," to enter the setting's submenu where you can choose between Normally Open ("N.O.") or Normally Closed ("N.C.").

Section 4.3

Operating the Shutter Externally

The AI25's optional shutter attachment can be controlled externally via USB or TTL pulses (5 V). The shutter's USB external control input is only enabled when toggled on using the "TTL / USB" () button. The shutter's TTL external control input, however, is always enabled, even if the shutter's USB external control input is also enabled.

To select between the TTL and USB external control inputs:

1. Press the "TTL / USB" () button once. Upon pressing this button, the Iris Status screen will indicate the external control input that you have selected.

Section 4.3.1

External Shutter Control: TTL

The shutter's TTL external control input allows you to control the shutter via an external exposure pulse. The chart in Fig. 26 shows the timing of the shutter when presented with the minimum exposure pulse the shutter will respond to.

The shutter's TTL external control input is always enabled, even if the shutter's USB external control input is also enabled.

See [Section 5.2](#) for signal specifications.

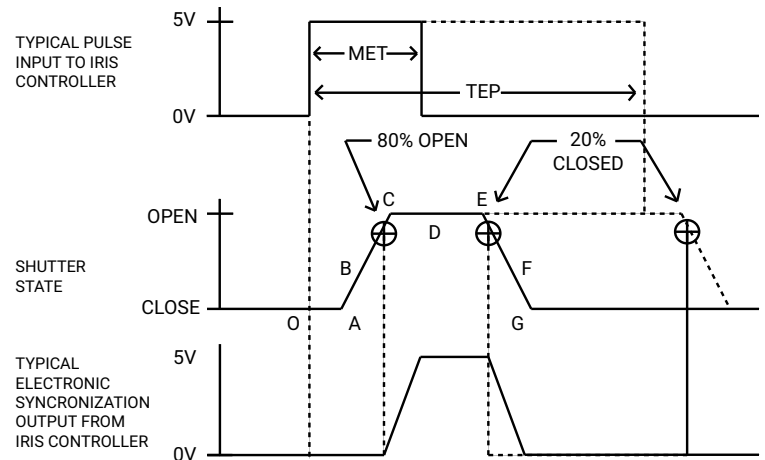

Fig. 26

Section 4.3.2

External Shutter Control: USB

There are four (4) serial commands specifically for the AI25's shutter attachment, with the exception that the "Reset" command will close the shutter and also reset the AI25 itself to the fully open position. See [Section 5.2](#) for a full list of system commands.

Command	Description	ASCII
SHUTTER "Open"	Opens shutter	@
SHUTTER "Close"	Closes shutter	A
SHUTTER "Trigger"	Toggles shutter state	B
SHUTTER/IRIS "Reset"	Closes shutter, opens iris	C

To set up and use the USB external control input:

1. Attach the included USB-AB cable to the rear of the AIC10 (using the cable's "B" connector), and then to a USB port on a compatible computer (using the cable's "A" connector) (Fig. 27).
2. Ensure that the USB external control input is selected by pressing the "TTL / USB" () button. The USB external control input is active when you see the screen shown in Fig. 28.
3. With the USB-AB cable properly connected, a compatible computer should automatically recognize the controller. If not, the USB driver can be downloaded and manually installed: <http://www.ftdichip.com/Drivers/CDM/CDM%20v2.12.04%20WHQL%20Certified.exe>
4. To test the USB external control input via a computer, use a terminal program such as Termit, available at: http://www.compuphase.com/software_termite.htm



Fig. 27



Fig. 28

Section 5.0

Specifications

System Characteristics

Name	Description
Shutter Repeat Exposure	<ul style="list-style-type: none"> • 65 ms minimum between exposures for 25 mm (aperture diameter) shutter • 165 ms minimum between exposures when 25 mm shutter is cycled continuously
Shutter Drive	<ul style="list-style-type: none"> • Continuously variable frequency of exposures from DC to the shutter's maximum rate • H-bridge type drive circuit for Bi-stable shutter • Maximum peak drive power: 14.5 W • Peak drive voltage: +10.7 VDC • Peak drive current: 1.34 A • Test conditions: Standard 8-ohm coil cycled with 40 ms exposure at 5 Hz • Fuse protected
Iris Drive	<ul style="list-style-type: none"> • Maximum peak drive power: 12 W • Peak drive voltage: +12 VDC • Peak drive current: 1.00 A • Fuse protected
Power Supply	<ul style="list-style-type: none"> • External tabletop AC/DC switching adaptor • Output: +12 VDC, 2.08 A, 25 W • Input: 100-240 VAC, 50/60 Hz, 0.60 A • IEC320-C14 AC inlet • 2.1 mm DC plug, Center pin positive

External Input Characteristics

Name	Description
PULSE INPUT (BNC)	<ul style="list-style-type: none"> • Operates optional shutter attachment • Active-high only • Input impedance: 1K Ω • Maximum sink current: 25 mA • Minimum pulse width: 35 ms <ul style="list-style-type: none"> • Maximum pulse width: Unlimited • TTL compatible: <ul style="list-style-type: none"> > Minimum high-level: +2.0 VDC > Maximum low-level: +0.8 VDC • Located on rear panel
IRIS TRIGGER (BNC)	<ul style="list-style-type: none"> • Operates AI25 Auto Iris • Active-high only • Input impedance: 1K Ω • Maximum sink current: 20 mA • Minimum pulse width: 16 μs <ul style="list-style-type: none"> • Maximum pulse width: Unlimited • TTL compatible: <ul style="list-style-type: none"> > Minimum high-level: +2.0 VDC > Maximum low-level: +0.8 VDC • Located on rear panel
IRIS DIR/POS (BNC)	<ul style="list-style-type: none"> • Operates AI25 Auto Iris • Level-triggered • Input impedance: 1K Ω • Maximum sink current: 25 mA <ul style="list-style-type: none"> • TTL compatible: <ul style="list-style-type: none"> > Minimum high-level: +2.0 VDC > Maximum low-level: +0.8 VDC • Located on rear panel
COM PORT (USB Type B)	<ul style="list-style-type: none"> • USB 2.0 full speed compatible • 9 input commands recognized • USB to UART synchronous serial data transfer interface • VCP settings: 8 data bits, 1 stop bit, no parity, no flow control <ul style="list-style-type: none"> • Includes royalty-free VCP drivers for Windows, MAC and Linux • Data transfer rate: 9600 baud • Located on rear panel

USB Control Protocols

Commands	Description	Decimal	HEX	Octal	Binary	ASCII
SHUTTER "Open"	Opens shutter	64	40	100	01000000	@
SHUTTER "Close"	Closes shutter	65	41	101	01000001	A
SHUTTER "Trigger"	Toggles shutter state	66	42	102	01000010	B
SHUTTER/IRIS "Reset"	Closes shutter, opens iris	67	43	103	01000011	C
IRIS "Decrement"	Closes iris one position (step)	68	44	104	01000100	D
IRIS "End"	Fully closes iris	69	45	105	01000101	E
IRIS "Goto"	Sends iris to requested position	71 ²	47 ²	107 ²	01000111 ²	GX1X2 ¹
IRIS "Home"	Fully opens iris	72	48	110	01001000	H
IRIS "Increment"	Opens iris one position (step)	73	49	111	01001001	I

¹ X1 and X2 are numerical positions of the iris where X1 is in the range of 0 to 5 and X2 is in the range of 0 to 9. See [page 27](#) for specific aperture sizes at a given position (step).

² These commands also require two additional characters for these commands to operate correctly and to go to your selected iris position.

AI25 Aperture Sizes (mm) at Given Position

Position (Step)	Measured Value (mm)	Position (Step)	Measured Value (mm)	Position (Step)	Measured Value (mm)	Position (Step)	Measured Value (mm)
00	25.0	14	18.8	28	13.0	42	7.1
01	24.7	15	18.4	29	12.5	43	6.6
02	24.2	16	18.0	30	12.2	44	6.2
03	23.7	17	17.5	31	11.7	45	5.7
04	23.3	18	17.1	32	11.3	46	5.3
05	22.8	19	16.7	33	10.9	47	4.8
06	22.3	20	16.3	34	10.5	48	4.3
07	21.9	21	15.9	35	10.1	49	3.9
08	21.4	22	15.5	36	9.6	50	3.4
09	21.0	23	15.0	37	9.2	51	2.9
10	20.6	24	14.6	38	8.8	52	2.4
11	20.1	25	14.2	39	8.4	53	2.0
12	19.7	26	13.8	40	7.9	54	1.5
13	12.2	27	13.4	41	7.5		

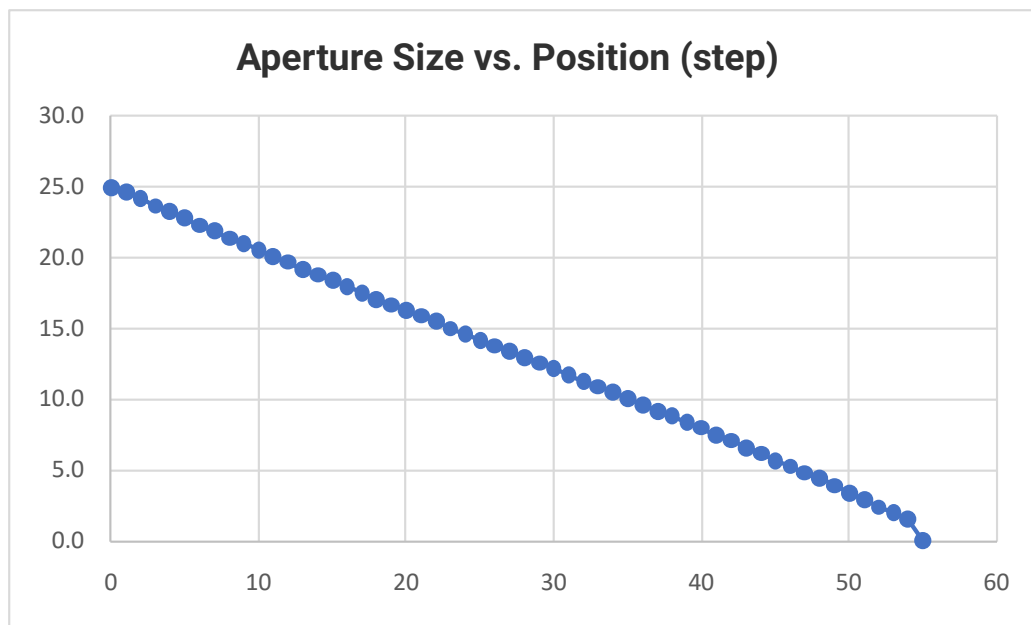

External Output Characteristics

Name	Description
SYNC OUTPUT (BNC)	<ul style="list-style-type: none"> Indicates shutter status Active-high only Maximum source current: 4 mA Minimum high-level: +4.9 VDC Maximum low-level: +0.4 VDC Enabled when optional shutter is attached Located on rear panel

General Characteristics

Name	Description
POWER Indicator	<ul style="list-style-type: none"> Green LED indicates when DC power is present Located on top panel
SHUTTER SYNC ACTIVE Indicator	<ul style="list-style-type: none"> Yellow LED indicates when the shutter's electronic synchronization sensor is active SYNC OUTPUT (BNC) will be active only when this LED is illuminated Located on top panel

Name	Description
Power Requirements	<ul style="list-style-type: none"> +12 VDC, 25 Watts Accessible with 2 mm DC jack Located on rear panel
Fuse Requirements (not user replaceable)	<ul style="list-style-type: none"> One 2 Amp "T" Slo-Blo (Nano SMT) for +12 VDC power One 1 Amp "T" Slo-Blo (Nano SMT) for Shutter coil One 1 Amp "T" Slo-Blo (Nano SMT) for IRIS motor One 125 mA "F" fast-acting (1206 SMT) for +5V supply of LCD
Operating Temperature	5° C to 40° C (41° F to 104° F)
Storage Temperature	-20° C to 55° C (-4° F to 131° F)
Relative Humidity	80% maximum
Altitude	Up to 2000 m (6562 ft), indoor use
Pollution	Degree 2
Overvoltage Class	Category II
Size (HWD)	<ul style="list-style-type: none"> Controller Unit: 3.12" x 7.00" x 5.50" (79.2 x 177.8 x 139.7 mm) Power Adaptor: 2.13" x 3.66" x 1.42" (54 x 93 x 36 mm)
Weight	<ul style="list-style-type: none"> Controller Unit: 1.05 lbs (476 g) Power Adaptor: 0.46 lbs (209 g)
Accessories	<ul style="list-style-type: none"> 103C IRIS/shutter interconnect cable PS12 +12 VDC external power adaptor North-American AC line cord, IEC type EURO style AC line cord, IEC type USB type A/B cable Quick-start guide card User manual (on USB flash drive)

Section 6.0

Warranty

Limited Product Warranty

LIMITED PRODUCT WARRANTY: All Products manufactured by VINCENT ASSOCIATES® (MANUFACTURER) are warranted to meet published specifications and to be free of defects in materials and workmanship as defined in the specifications for 365 days - one year - (WARRANTY PERIOD) from the date of original shipment of the product. DSS series shutters are additionally warranted as defined in the DSS SERIES CYCLE WARRANTY CRITERION below. MANUFACTURER will, at its own option within the WARRANTY PERIOD, repair or replace without charge any listed item discovered to be defective excepting transportation charges. Burned out or otherwise damaged actuator coils are not covered under this warranty. Any defective product returned to the MANUFACTURER must follow the RETURN MATERIAL AUTHORIZATION PROCEDURE as defined below. This warranty does not extend to cover damage resulting from alteration, misuse, negligence, abuse, normal wear and tear, or accident. The MANUFACTURER will consider the return of unused equipment if returned within 30 days from the original date of shipment, subject to a 20% restocking charge. This offer does not apply to used or damaged equipment. This warranty extends only to the original purchase and is not available to any third party, including any purchaser assemblies or other Products of which the goods may become component equipment.

DSS SERIES CYCLE WARRANTY CRITERION: The DSS10B, DSS20B and DSS25B, are guaranteed for 2,000,000 operations or one year. DSS35B devices are guaranteed for 5,000,000 operations or one year. One "operation" is considered one open and one closure of the shutter. DSS Shutters (excluding the DSS35B) must be operated with the ED12DSS or VED24 driver. The DSS35B shutter devices must be operated with the VED24 driver. All DSS Shutters must be operated within the defined environmental, electrical and mechanical specifications as listed on the device's data sheet. After one year (WARRANTY PERIOD), the cycle warranty is null and void. If returned, the device must be accompanied by a written statement indicating the approximate number of cycles contained on the device, include all parameters to which the shutter was operated and follow the RETURN MATERIAL AUTHORIZATION PROCEDURE as defined below.

RETURN MATERIAL AUTHORIZATION PROCEDURE: MANUFACTURER will only accept returned Products from customers that have obtained an RMA (Return Material Authorization) number from the MANUFACTURER. The customer must also include an itemized statement of defect(s). The Product will then be evaluated per the MANUFACTURER'S standard repair guidelines. Any Product which has been returned to the MANUFACTURER but which is found to meet the applicable specifications and not defective in materials and workmanship shall be subject to the MANUFACTURER's standard evaluation charge. The MANUFACTURER assumes no liability for customer returned material.

LIMIT OF LIABILITY: The buyer's exclusive remedy and the limit of MANUFACTURER'S liability for any loss whatsoever shall not exceed the purchase price paid by the buyer for the goods to which a claim is made. MANUFACTURER does not give any implied warranties of merchantability, fitness for a particular purpose, or of any other nature in connection with the sale of any Products.

Section 7.0

Declaration of Conformity

Declaration of Conformity

VA, Inc. dba Vincent Associates®



Vincent Associates
803 Linden Avenue
Rochester, NY 14625
Tel: [800-828-6972](tel:800-828-6972)
www.uniblitz.com

Description of Equipment:

The following product is manufactured in the United States of America by Vincent Associates:
Uniblitz® AIC10 Auto Iris and Shutter Controller

EU Declaration of Conformity (EMC):

Vincent Associates hereby declares that under its sole responsibility, and based on tests performed by G&M Compliance Inc., that the aforementioned product meets the requirements of the **EU EMC Directive 2014/30/EU** by means of conformity to the following harmonized standards:

Applied EMC Standards

EN 61326-1: 2013 – EMC requirements for electrical equipment for measurement, control, and laboratory use — Part 1: General requirements

EN 61326-1 Group 1 Class B – Conducted Emissions. Conducted disturbances at Mains Terminal

EN 61326-1 Group 1 Class B – Radiated Emissions. Radiated disturbances emanating from AIC10

EN 61000-3-2 (2014) – Harmonic Emissions - The AC mains current harmonics test requirements are derived from EU CE mark directives.

EN 61000-3-3 (2013) – Voltage Fluctuations & Flicker Test - The AC mains voltage flicker test requirements are derived from EU CE mark directives.

IEC 61000-4-2:2009 – Electromagnetic compatibility (EMC) - Part 4-2: Testing and measurement techniques - Electrostatic discharge immunity test

IEC 61000-4-3:2006 +A1+A2 – Electromagnetic compatibility (EMC) - Part 4-3: Testing and measurement techniques – Radiated radio-frequency, electromagnetic field immunity test

IEC 61000-4-4:2004 +A1 – Electromagnetic compatibility (EMC) - Part 4-4: Testing and measurement techniques - Electrical fast transient/burst immunity test

IEC 61000-4-5:2006 – Electromagnetic compatibility (EMC) - Part 4-5: Testing and measurement techniques - Surge immunity test

IEC 61000-4-6:2009 – Electromagnetic compatibility (EMC) - Part 4-6: Testing and measurement techniques - Immunity to conducted disturbances, induced by radio-frequency fields

IEC 61000-4-8:2010 – Electromagnetic compatibility (EMC) – Part 4-8: Testing and measurement techniques – Power frequency magnetic field immunity test

IEC 61000-4-11:2004 – Electromagnetic compatibility (EMC) - Part 4-11: Testing and measurement techniques - Voltage dips, short interruptions and voltage variations immunity tests

EU Declaration of Conformity (LVD):

Vincent Associates hereby declares that under its sole responsibility, and based on tests performed by G&M Compliance Inc., that the aforementioned product meets the requirements of the **EU Low Voltage Directive 2014/35/EU** by means of conformity to the following harmonized standard:

Applied LVD Standards

IEC/EN 61010-1:2010 – Safety requirements for electrical equipment for measurement, control, and laboratory use — Part 1: General requirements

CE Mark

CE Mark first applied to this product April 20, 2018.



Stephen T. Pasquarella
President

Original Date: April 20, 2018
Updated:



Need Support? Please [visit our website](#) or email us at info@uniblitz.com.

Tel: [585-385-5930](tel:585-385-5930) | Toll-Free: [800-828-6972](tel:800-828-6972) | Fax: 585-385-6004 | 803 Linden Ave. Rochester, NY 14625

Updated 6/18 | Manual Version 1.4 | ©2018 Vincent Associates