

CellIX

The Universal Light Engine for Free-Space Applications, Flow Cytometry, and Microscopy

CellIX is a multi-wavelength platform for use as the laser excitation Light Engine in applications requiring up to 4 lasers from a single module. CellIX can serve three applications with its different models and accessories: 1) Stand-alone free-space laser engine, 2) Flow Cytometry with the beam diameters and adjustments for the best focus spot size and stripe locations, and 3) Microscopy with a common 0.7mm output beam and fiber aligner with FC/APC or collimated output.

CellIX delivers up to four circular laser beams from a single, compact module. This includes user-adjustable steering and telescopes used to optimize the beams to your target requirements. For example, CellIX can be aligned to give flexible patterns of focused stripes in a flow cytometer when used with the line-generating objective optics. CellIX also has a version with all 0.7 mm beam diameters to serve as a stand-alone laser engine or work with a fiber aligner to optimize power transmission.

Using the same optical cores that are at the heart of the Coherent OBIS suite of lasers, CellIX delivers best-in-class optical performance and reliability.

With its low cost, alignment flexibility and ease-of-integration, CellIX is the universal laser Light Engine for your application.



FEATURES

- Up to 4 wavelengths
- OBIS Laser performance for high-quality high-performance beams
- Common power, control, and interface
- User-adjustable beam steering and telescopes

APPLICATIONS

- Flow Cytometry
- Microscopy
- Particle Measuring
- Medical Imaging
- Optogenetics

Shown below are the three applications and accessories. Each enables CellIX to be the ideal choice as a stand-alone laser engine, or the application solution for Flow Cytometry lasers, or with 4-lasers into a fiber delivery.

1) CellIX - the four laser free-space output laser engine with adjustable beam steering and divergence (focus)



CellIX has built in lasers, telescope, beam combiner, beam steering, and electronics



CellIX by itself is a powerful 1 to 4 laser system with adjustable divergence (focus) and beam steering/spacing

2) CellIX for Flow Cytometry and Particle Measuring



CellIX with Heat Sink and Objective Lens. Offers the focus beam stripes and stripe separation for a Flow Cytometer or Particle Measuring applications.

3) CellIX for Microscopy



CellIX where the CellIX has all four beams with 0.7mm for coupling to a fiber. With CellIX telescope adjustments and beam steering to optimize the coupling.

Specifications	CellIX 405	CellIX 488	CellIX 561	CellIX 637
Spatial Mode	TEM ₀₀			
M ² (Beam Quality) ¹	≤1.3			
Beam Asymmetry (circular beam)	≤1:1.2			
Pointing Stability Over Temperature (μrad/°C)	<10			
Beam Colinearity ² (μrad)	<100			
RMS Noise ³ (%) (20 Hz to 20 MHz)	<0.25			
Peak-to-Peak Noise ³ (%) (20 Hz to 20 kHz)	<1			
Long-Term Power Stability (%) (8 hours, ±3°C)	<2			
Warm-Up Time (minutes) (from cold start)	<5			
Polarization Extinction Ratio	>50:1	>75:1	>50:1	>50:1
Polarization Azimuth	Vertical ±5°			

Notes:

1. Beam Quality (M²) measured per laser channel using ModeMaster with 90/10 clip levels.
2. Standard alignment. User adjustable.
3. RMS Noise and Peak-to-Peak Noise Specifications are per laser channel, during CW operation at nominal Output Power.
4. Typical power-on delay of 1 minute from cold start.

CellIX offers common bolt pattern to support objective lens, shutter, or fiber launcher.

Example of CellIX with Laser Output Shutter attached.



CellIX with USB, Control I/O, Status LEDs, and Power Input Connector. Shown Mounted on the optional fan-cooled heat sink.



Control Specifications	
Interface for Computer Control	USB (mini-B) and RS-232 (from DB37, 115200 Baud)
Laser Drive Modes (Four Operating Modes, individually selected for each wavelength thru USB or RS-232)	1) CW with Power Control via USB/RS-232 2) Analog Modulation 3) Digital Modulation 4) Mixed Analog and Digital Modulation (simultaneous Analog and Digital)
Digital Modulation Voltage and Impedance ¹ Maximum Bandwidth (kHz) Rise Time (10% to 90%) (µsec) Fall Time (90% to 10%) (µsec) Modulation Depth (extinction ratio) Power Range	0-3.3V, 2 kOhm input impedance each, Normally Low (off) 50 <5 <5 Infinite Modulate from 0% to Set Power (USB or RS-232) in Digital Mode
Analog Modulation Voltage and Impedance Maximum Bandwidth, 3dB (kHz) Rise Time (10% to 90%) (µsec) Fall Time (90% to 10%) (µsec) Modulation Depth (extinction ratio)	0 to 5V, 2 kOhm input impedance each, Normally Low (off) 50 <5 <5 >50:1, Typical 100:1
Power Range	Modulate from 0% to 110% with 0 to 5V in Analog Mode

Notes:

1. Digital input is 5V tolerant.

Mechanical and Environmental Specifications	CellX
Dimensions ¹ (mm) (L x D x H)	155 x 180 x 52.2
Beam Position from Reference ¹ (mm)	<0.5
Beam Angle (mrad)	<5
Laser Safety Classification ²	4
ESD Protection	EN61326-1 (8 kV Air Discharge, 4 kV Contact Discharge)
Baseplate Operating Temperature (°C)	10 to 45
Heat Dissipation of Laser Head ³ (Watts)	Typical 20, Maximum 60
Ambient Temperature ⁴ (°C)	10 to 45
Non-Operating Condition (°C)	-20 to +60
Shock Tolerance (6 ms)	30g
Weight (kg)	2.2
Electrical Specifications	
Power Input Connector	Use Molex 0430250600 for Power Cable Connector, Pins 1, 2, 3 for Power, Pins 4, 5, 6 for Ground
Supply Voltage (V DC)	12 ± 2 (100 Watt minimum)
Power Consumption (W)	Typical 20, Maximum 60

Notes:

1. See mechanical drawing.
2. OEM Product - does not comply with CDRH 21CFR 1040.10 and 1040.11 without appropriate integration.
3. Typically 85% of heat load through the base plate. See Operator's Manual for more detail.
4. Non-condensing. See Operator's Manual for more detail (available on coherent.com).

Mechanical Specifications

OBIS CellX

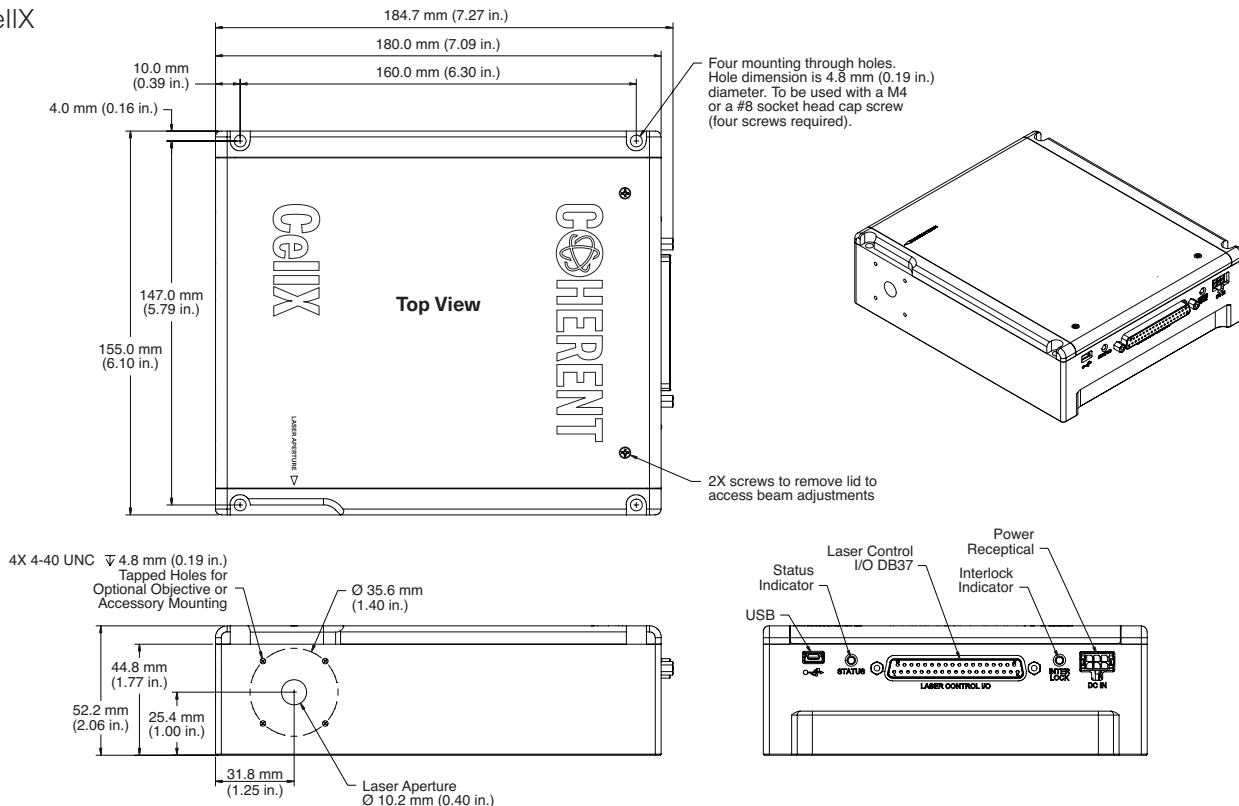

CellIX includes beam expanders to create larger beam diameter at the longer wavelength; for the benefit of each wavelength having the same focus spot size (when used with a Coherent CellIX Objective Lens).

Optical Specifications	CellIX 405	CellIX 488	CellIX 561	CellIX 637
Wavelength ¹ (nm)	405	488	561	637
Output Power ² (mW)				
Part Number				
1426532	-	50	-	-
1426531	-	50	-	50
1426530	-	50	50	-
1426529	50	50	-	-
1318680	50	50	n/a	50
1318682	50	50	50	50
1318681	100	100	n/a	100
1318683	100	100	100	100
Beam Diameter at 1/e ² (mm)	2.6	3.0	3.5	4.5
Beam Divergence (mrad, full angle)	0.2			

- Notes:
1. Laser-to-laser center wavelength tolerance: 405 nm ±5 nm, 488 nm and 561 nm with ±2 nm, 637 nm with 632 to 643 nm range. Short-pass filter suppression of out-of-band emission for 640 nm.
 2. Output power is measured at the output aperture of CellIX. Power is variable in CW Mode from 1% (405 nm and 637 nm) to 110% of rated power. Output power is variable in CW Mode from 10% (488 nm and 561 nm) to 110% of rated power. Specifications are valid for 100% power. For 488 nm and 561 nm any residual laser emission at 808 nm fundamental is <0.1 mW.

CellIX for Flow Cytometry and Particle Measuring has telescopes to provide stronger magnification at the longer wavelengths. This provides the advantage at the focus of having a consistent beam focus height.

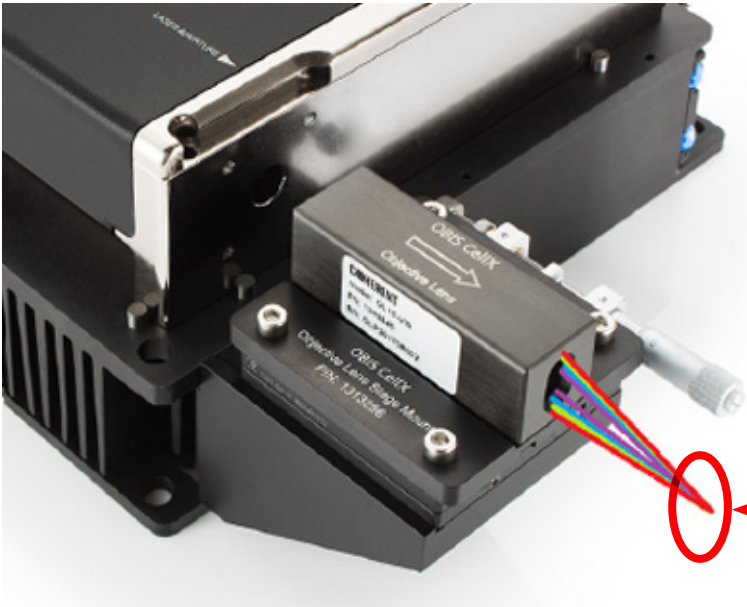

CellIX provides larger beam diameters from violet to red to then provide the higher performance uniform focus spot height.

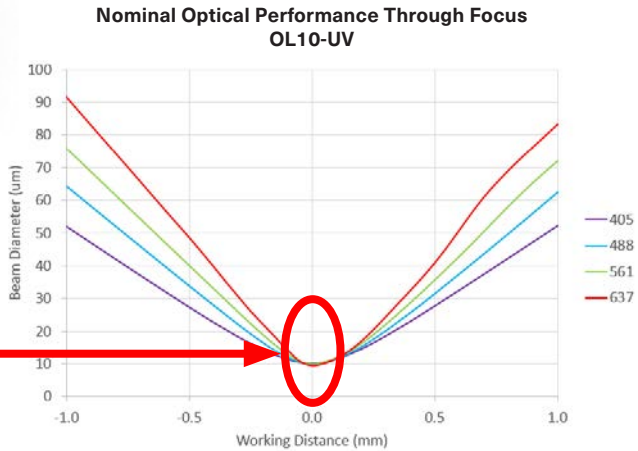

CellIX for Flow Cytometry and Particle Measuring offers objective lens accessories to focus the beam and create a line at the focus.

Optical Performance Specifications	CellIX Objective Lens Accessories	
	OL10-UV	OL15-UV
Part Number	1365935	1383130
Wavelength Range (nm)	350 to 700	
Beam Profile at Focus	Gaussian Profile on both the Vertical and Horizontal Axis	
Focus Spot Size Vertical (μm) ($1/e^2$)	10 \pm 2	15 \pm 3
Focus Spot Size Horizontal ¹ (μm) ($1/e^2$)	60 \pm 15	90 \pm 20
Working Distance ² (mm)	36.4	60.9
Dimensions (mm)	22 x 22 x 47.2	22 x 22 x 59.7
Vertical Adjustment ^{3,4} (μm)	\pm 250	
Horizontal Adjustment ^{3,4} (μm)	\pm 250	
Focus Adjustment ⁵	Independent focus adjustment of all wavelengths	

Notes:

1. Measured at location of best vertical focus. System aligned to lower limit on delivery. Horizontal beam size can be adjusted up to the upper limit. System may be adjusted to reduce or expand the horizontal focus width. See Operator's Manual.
2. Measured from mechanical surface (output end) of the objective assembly.
3. Measured from nominal beam axis. Adjustment using tilt/yaw adjustment internal to CellIX, while meeting all optical specifications.
4. Assumes the objective assembly mounted within less than 200 mm (optical path length) from the output face of CellIX.
5. Adjustment using telescope adjustment internal to CellIX, while meeting all optical specifications.

Nominal Optical Performance for the Focus of the Objective Lenses

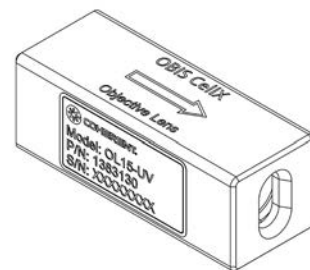
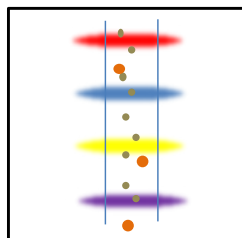
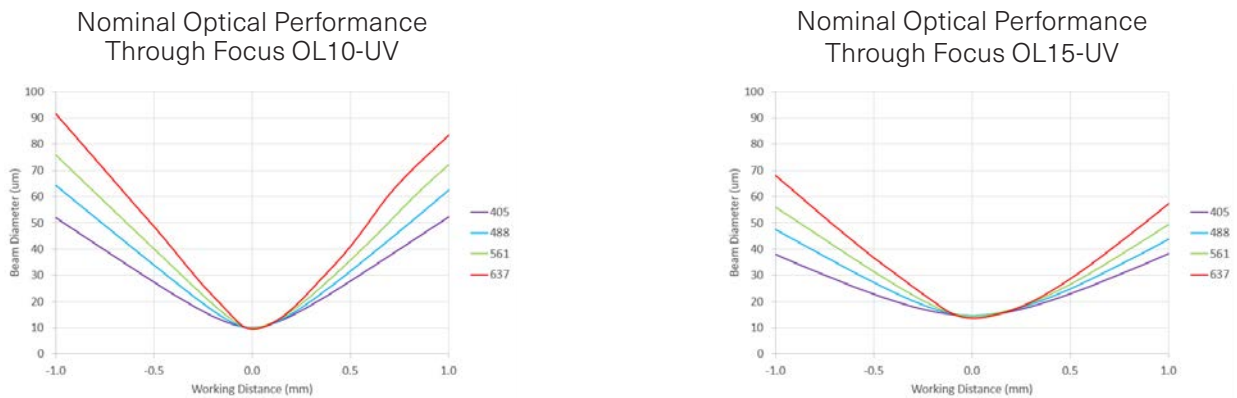







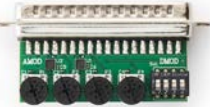

Flow Cytometry Example:
Four-laser Focus with Separated
Positions (user-adjustable)

Part Number	Laser
1426532	CellX Laser 1x50 mW 488 nm
1426531	CellX Laser 2x50 mW 488, 637 nm
1426530	CellX Laser 2x50 mW 488, 561 nm
1426529	CellX Laser 2x50 mW 405, 488 nm
1318680	CellX Laser 3x50 mW 405, 488, 637 nm
1318682	CellX Laser 4x50 mW 405, 488, 561, 637 nm
1318681	CellX Laser 3x100 mW 405, 488, 637 nm
1318683	CellX Laser 4x100 mW 405, 488, 561, 637 nm
Part Number	Accessory
1323532	Developer's Kit, includes CellX System 4x100 mW 405, 488, 561, 637 nm and all parts below
1321203	Accessory Kit for CellX (Alignment Tools, Interlock Plug, USB Cable, Coherent Connection, User Manual)
1365935	Accessory, Objective Lens, OL10-UV 10 μ m Focus, CellX
1383130	Accessory, Objective Lens, OL15-UV 15 μ m Focus, CellX
1321963	Accessory, Mount, Front Aperture Objective Holder, CellX
1321964	Accessory, Translation Stage with Mount for Objective Lens, CellX
1323285	Heatsink, Fan-Cooled with Stage Platform Extension, CellX
1315322	Heatsink, OEM, CellX
1299911	Accessory, Control Board, Adjustable Power, CellX
1298365	Accessory, Control Board, Key-Switch, RS-232, Digital/Analog SMB, CellX
1313160	Accessory, Interlock Plug, DB37, CellX
1323597	Accessory, Control Board, 4 Analog Modulation Inputs, RS-232
1211389	Power Supply, CellX

Shown here are two choices for heat sinks, four choices for electronic interface and two choices for Objective Lens assemblies for Flow Cytometry.



	Name	Part Number	Description
	CellIX Accessory Kit, Interlock Plug	1321203	Alignment Tools, Interlock Plug, USB Cable, Coherent Connection Software, Operator's Manual
	CellIX Control Board, Analog Modulation, RS-232	1323597	Control Board for OBIS CellIX, DB37 with four Analog Modulation Inputs and RS-232 communication
	CellIX Control Board, Adjustable Power	1299911	Control Board for OBIS CellIX with four laser output power adjustment knobs
	CellIX Control Board, Key Switch, RS-232, Digital and Analog Modulation	1298365	Control Board for OBIS CellIX with Key Switch, Interlock, RS-232, Four Analog Modulation inputs and Four Digital Modulation inputs
	CellIX Mount for Objective Lens	1321963	Mounting kit to mount the Objective Lens to the OBIS CellIX
	CellIX Objective Lens, OL10-UV, 10 µm Focus	1365935	OBIS CellIX Objective Lens to create a focus of 10 x 60 µm at a distance of 36.4 mm

	Name	Part Number	Description
	CellIX Objective Lens, OL15-UV, 15 µm Focus	1383130	OBIS CellIX Objective Lens to create a focus of 15 x 90 µm at a distance of 60.9 mm
	CellIX Translation Stage with Mount for Objective Lens	1321964	Mount and Stage to translate the OBIS CellIX Objective Lens to optimize the focus location
	CellIX Heatsink, Fan Cooled with Platform Extension	1323285	OBIS CellIX Heatsink with cooling fans and platform extension for Objective Lens stage
	CellIX Heatsink, OEM	1315322	OBIS CellIX compact heatsink, OEM version. Requires hole in mounting plate to allow heatsink to protrude through the optics deck and requires that the OEM provide air flow.

Looking for a CellIX with all 0.7 mm beam diameters like the OBIS LX/LS lasers? CellIX with a common 0.7 mm beam diameter offers all the CellIX advantages of an adjustable internal beam expander as well as adjustable internal beam steering. CellIX with common 0.7 mm beam diameter is an excellent choice for fiber launch.

Optical Specifications	CellIX 405	CellIX 488	CellIX 561	CellIX 637
Wavelength ¹ (nm)	405	488	561	637
Output Power ² (mW)				
Part Number 1424660	100	100	100	100
Beam Diameter at 1/e ² (mm) (typical)	0.7			
Beam Divergence (mrad, full angle)	1.8			

- Notes:
1. Laser-to-laser center wavelength tolerance: 405 nm ±5 nm. 488 nm and 561 nm with ±2 nm, 637 nm with 632 to 643 nm range. Short-pass filter suppression of out-of-band emission for 640 nm.
 2. Output power is measured at the output window of CellIX. Power is variable in CW Mode from 1% (405 nm and 637 nm) to 110% of rated power. Output power is variable in CW Mode from 10% (488 nm and 561 nm) to 110% of rated power. Specifications are valid for 100% power. For 488 nm and 561 nm any residual laser emission at 808 nm fundamental is <0.1 mW.

CellIX with common 0.7 mm beam diameter is an excellent choice for a fiber launch.



The CellX can be provided with fiber delivery from Coherent. The CellX with a common 0.7 mm beam diameter is coupled to a fiber launcher and can then be configured with a fiber. Fiber options include an FC/APC output connector or a collimated beam fiber output.

Specifications	CellX 405	CellX 488	CellX 561	CellX 637
Wavelength ¹ (nm)	405	488	561	637
Output Power ² (mW)	100	100	100	100
Beam Diameter at 1/e ² (mm)	0.7	0.7	0.7	0.7
Part Number ³	2309585 2309912	Includes Fiber Launcher and Fiber with Collimated Beam Output Includes Fiber Launcher and Fiber with FC/APC Output		

Notes:

1. Laser-to-laser center wavelength tolerance: 405 nm \pm 5 nm, 488 nm and 561 nm with \pm 2 nm, 637 nm with 632 to 643 nm range. Short-pass filter suppression of out-of-band emission for 640 nm.
2. Output power is measured at the output aperture of CellX. Power is variable in CW Mode from 1% (405 nm and 637 nm) to 110% of rated power. Output power is variable in CW Mode from 10% (488 nm and 561 nm) to 110% of rated power. Specifications are valid for 100% power. For 488 nm and 561 nm any residual laser emission at 808 nm fundamental is <0.1 mW.
3. Alignment Tube included, supports an alignment of the Fiber Launcher as necessary. CellX ships with Fiber Aligner bolted to the front; customer to insert fiber into Fiber Launcher.

Fiber Specifications. Fiber Delivery with FC/APC or collimated beam output.

Performance	
Operating Wavelength (nm)	400 to 645
Maximum Input Power (mW)	500 (\leq 200 at 400 to 460 nm)
Polarization Extinction Ratio ¹ (dB)	\geq 20
Coupling Efficiency ² (%)	\geq 65 (typical 75%)
Long-Term Power Throughput ³	95
Fiber Lifetime ⁴	2500 hours continuous operation
Optical Fiber Parameters	
Length (m)	2
Stainless Steel Sheathing OD (mm)	4.8
Collimated Beam Output	
Beam Diameter (mm)	0.6 \pm 0.15
M ²	\leq 1.1
Output Collimator Dimensions (mm)	\varnothing 12 x 50
Collinearity (mrad)	<0.25
Asymmetry	1 \pm 0.1
Astigmatism (%)	<20
Pointing Angle (Boresight) (mrad)	<0.5
Divergence (mrad)	<1.8
FC/APC Beam Output	
Numerical Aperture (NA)	0.07 to 0.1
Environmental Conditions	
Shipping Temperatures (°C)	-20 to 60
Operating Temperatures (°C)	10 to 40
Humidity	Non-condensing



Notes:

1. PER measured with four laser sources (405, 488, 561, 637 nm) with \geq 500:1 input polarization within \pm 1° azimuth.
2. With CellX the Coupling Efficiency is >60% for each wavelength 405, 488, 561 and 637 nm.
3. 8 hours \pm 3 °C.
4. \leq 5% drop in coupling efficiency, not including changes due to thermal or mechanical effects.

Part Number	Laser
2309585	CellX FR Laser 4x100 mW 405 nm, 488 nm, 651 nm, 637 nm, Fiber Ready, Fiber/Launcher for Collimated Output
2309912	CellX FR Laser 4x100 mW 405 nm, 488 nm, 651 nm, 637 nm, Fiber Ready, Fiber/Launcher for FC/APC Output
Part Number	Accessory
1321203	Accessory Kit for CellX (Alignment Tools, Interlock Plug, USB Cable, Coherent Connection, User Manual)
2324764	Heatsink, Fan-Cooled with No Stage Platform Extension, CellX
1315322	Heatsink, OEM, CellX
1299911	Accessory, Control Board, Adjustable Power, CellX
1298365	Accessory, Control Board, Key-Switch, RS-232, Digital/Analog SMB, CellX
1313160	Accessory, Interlock Plug, DB37, CellX
1323597	Accessory, Control Board, 4 Analog Modulation Inputs, RS-232
1211389	Power Supply, CellX



	Name	Part Number	Description
	CellIX Accessory Kit, Interlock Plug	1321203	Alignment Tools, Interlock Plug, USB Cable, Coherent Connection Software, Operator's Manual
	CellIX Control Board, Analog Modulation, RS-232	1323597	Control Board for OBIS CellIX, DB37 with four Analog Modulation Inputs and RS-232 communication
	CellIX Control Board, Adjustable Power	1299911	Control Board for OBIS CellIX with four laser output power adjustment knobs
	CellIX Control Board, Key Switch, RS-232, Digital and Analog Modulation	1298365	Control Board for OBIS CellIX with Key Switch, Interlock, RS-232, Four Analog Modulation inputs and Four Digital Modulation inputs
	CellIX Heatsink, Fan Cooled	2324764	OBIS CellIX Heatsink with No Stage Platform Extension with cooling fans
	CellIX Heatsink, OEM	1315322	OBIS CellIX compact heatsink, OEM version. Requires hole in mounting plate to allow heatsink to protrude through the optics deck and requires that the OEM provide air flow.

	Name	Part Number	Description
	Adjustable Fiber Aligner with Alignment Sleeve	2313364	Adjustable Fiber Aligner. Includes alignment tool and mounting hardware. Bolts onto front of CellIX laser. Can be used to adjust fiber assembly to the optimal position for maximum output power transmission.
	Fiber Assembly, FC/APC Termination, 2m Long	2313508	Fiber Assembly with FC/APC Output. Includes integrated optics for the fiber input launch. 2 meters long.
	Fiber Assembly, Collimated Termination, 2m Long	2313509	Fiber Assembly with collimated beam output. Includes integrated optics for the fiber input launch. 2 meters long

Mechanical Specifications

CellIX Fiber Assembly with FC/APC output

