

*User Manual*  
*EnergyMax™-USB/RS*  
*Sensor System*





*User Manual*  
*EnergyMax-USB/RS*  
*Sensor System*



27650 SW 95th Ave.  
Wilsonville, OR 97070

This document is copyrighted with all rights reserved. Under the copyright laws, this document may not be copied in whole or in part or reproduced in any other media without the express written permission of Coherent, Inc. Permitted copies must carry the same proprietary and copyright notices as were affixed to the original. This exception does not allow copies to be made for others, whether or not sold, but all the material purchased may be sold, given or loaned to another person. Under the law, copying includes translation into another language.

Coherent, the Coherent Logo, and EnergyMax are trademarks or registered trademarks of Coherent, Inc. All other trademarks or registered trademarks are the property of their respective owners.



Every effort has been made to ensure that the data given in this document is accurate. The information, figures, tables, specifications and schematics contained herein are subject to change without notice. Coherent makes no warranty or representation, either expressed or implied with respect to this document. In no event will Coherent be liable for any direct, indirect, special, incidental or consequential damages resulting from any defects in its documentation.

### Technical Support

#### In the US:

Should you experience difficulties with your product, or need technical information, visit our website: [www.Coherent.com](http://www.Coherent.com). You can obtain additional support by either telephoning our Technical Support Hotline at 1.800.343.4912, or e-mailing our Support Team at [support.instruments@Coherent.com](mailto:support.instruments@Coherent.com). Telephone coverage is available Monday through Friday (except U.S. holidays).

If you call outside our office hours, your call will be taken by our answering system and will be returned when the office reopens.

If there are technical difficulties with your product that cannot be resolved by support mechanisms outlined above, e-mail or telephone Coherent Technical Support with a description of the problem and the corrective steps attempted. When communicating with our Technical Support Department via the web or telephone, the model and serial number of the product will be required by the Support Engineer responding to your request.

#### Outside the US:

If you are located outside the U.S., visit our website for technical assistance, or telephone our local Service Representative. Representative phone numbers and addresses can be found on the Coherent website: [www.Coherent.com](http://www.Coherent.com).

Coherent provides web and telephone technical assistance as a service to its customers and assumes no liability thereby for any injury or damage that may occur contemporaneous with such services. These support services do not, under any circumstances, affect the terms of any warranty agreement between Coherent and the buyer. Operating a Coherent product with any of its interlocks defeated is always at the operator's risk.

# TABLE OF CONTENTS

Signal Words and Symbols in this Manual .....	vii
Signal Words .....	vii
Symbols .....	viii
Preface .....	ix
Export Control Laws Compliance .....	ix
Publication Updates .....	ix
Unpacking and Inspection .....	ix
Post and Stand Assembly .....	x
<b>Safety</b> .....	1-1
Environmental Regulations .....	1-1
RoHS Compliance .....	1-1
Waste Electrical and Electronic Equipment (WEEE, 2002) .....	1-1
Declaration of Conformity .....	1-2
<b>Description</b> .....	2-1
Introduction .....	2-1
Product Overview .....	2-2
Product Features .....	2-2
Software Features .....	2-3
Sensor Overview .....	2-3
MaxBlack EnergyMax Sensors .....	2-4
Diffuse Metallic EnergyMax Sensors .....	2-5
MaxBlack EnergyMax Sensors With Diffusers .....	2-6
MaxUV EnergyMax Sensors .....	2-7
Quantum EnergyMax Sensor .....	2-8
<b>Technical Description</b> .....	3-1
Increasing Average Power With Heatsinks .....	3-1
Pyroelectric Technology .....	3-2
Damage Thresholds .....	3-3
Measurement Linearity .....	3-4
Energy Linearity .....	3-4
Repetition Rate Linearity .....	3-4
Average Power Linearity .....	3-4
Temperature Linearity of Quantum EnergyMax Sensors .....	3-5
Pulse Width Linearity .....	3-5
Spectral Response .....	3-5
Applying Wavelength Compensation Accuracy .....	3-6
<b>Operation</b> .....	4-1
LED Status Indicator .....	4-1
Powering EnergyMax-RS Sensors .....	4-2

Pyroelectric Watts Mode .....	4-2
Triggering.....	4-3
Internal Triggering Mode.....	4-3
Setting the Wavelength .....	4-4
Tutorial: Measuring Energy With a EnergyMax Sensor.....	4-5
Tutorial: Synchronization .....	4-7
Procedure: Taking a Synchronized A/B Ratiometric Reading .....	4-7
Tutorial: Turbo Mode.....	4-12
Procedure: Using Turbo Mode.....	4-12
Using the Software.....	4-14
<b>Special Topics</b> .....	<b>5-1</b>
Understanding the External Trigger Circuit.....	5-1
Extending Cable Length .....	5-2
<b>Host Interface</b> .....	<b>6-1</b>
Overview.....	6-1
Message Terminators .....	6-1
Messages Received by the Sensor .....	6-1
Messages Sent by the Sensor .....	6-1
Host Command Quick Reference .....	6-2
SCPI Interface Section.....	6-4
Syntax and Notation Conventions .....	6-4
Commands and Queries .....	6-4
SCPI Common Commands.....	6-4
System Options .....	6-5
Error Record Reporting and Collection .....	6-6
Measurement Setup and Control.....	6-8
Statistics Mode Control.....	6-11
Trigger Parameters.....	6-12
Measurement Data Collection .....	6-14
Data Streaming Transmission Interface Gating.....	6-16
Sensor Information .....	6-16
Calibration .....	6-17
Data Streaming Transmission Interface Section.....	6-17
Operational Parameters.....	6-18
Host Interface Glossary .....	6-18
<b>Calibration and Warranty</b> .....	<b>7-1</b>
Coherent Calibration Facilities and Capabilities .....	7-1
Optical Calibration Method .....	7-2
EnergyMax NIST Traceable Optical Calibration .....	7-2
Re-certify Once a Year.....	7-2
Calibration Fundamentals .....	7-2
Calibration Verification.....	7-3
Limited Warranty .....	7-3
Extended Warranty.....	7-4

Warranty Limitations .....	7-4
Obtaining Service .....	7-5
Product Shipping Instructions.....	7-6
<b>Appendix A: Frequently Asked Questions .....</b>	<b>8-1</b>
<b>Index .....</b>	<b>9-1</b>

## LIST OF FIGURES

1-1. Waste Electrical and Electronic Equipment Label.....	1-1
2-1. Spectral Sensitivity Curves for Quantum EnergyMax Sensor.....	2-8
3-1. Pyroelectric Current and Voltage Response.....	3-3
3-2. Photo Sensitivity Temperature Characteristics .....	3-5
3-3. Spectral Absorption of EnergyMax Sensor Coatings .....	3-7
3-4. Spectral Sensitivity of EnergyMax Sensors With Diffusers .....	3-8
4-1. Average Power Diagram .....	4-2
4-2. Internal Trigger Threshold .....	4-4
5-1. External Trigger Input Circuitry .....	5-1
5-2. EnergyMax-USB Standard Cable .....	5-2
7-1. Ratiometric Method of Optical Calibration .....	7-3

## LIST OF TABLES

2-1. MaxBlack EnergyMax Sensor Specifications .....	2-4
2-2. Diffuse Metallic EnergyMax Sensor Specifications .....	2-5
2-3. MaxBlack EnergyMax Sensor With Diffusers Specifications.....	2-6
2-4. MaxUV EnergyMax Sensor Specifications .....	2-7
2-5. Quantum EnergyMax Sensor Specifications .....	2-9
3-1. Average Power Ratings.....	3-2
3-2. Available Heatsinks .....	3-2
3-3. EnergyMax Damage Thresholds Capabilities .....	3-3
3-4. Wavelength Compensation Accuracy .....	3-6

4-1.	EnergyMax-USB/RS LED Light Conditions.....	4-1
6-1.	Host Command Quick Reference .....	6-2
6-2.	Error Codes and Description Strings .....	6-7
6-3.	Measurement Data Record Formats—Statistics Mode Off .....	6-15
6-4.	Measurement Data Record Formats—Statistics Mode On .....	6-15
6-5.	Flag Character Definitions .....	6-15
6-6.	Operational Parameters .....	6-18
7-1.	Coherent Service Centers.....	7-5



## Signal Words and Symbols in this Manual

This documentation may contain sections in which particular hazards are defined or special attention is drawn to particular conditions. These sections are indicated with signal words in accordance with ANSI Z-535.6 and safety symbols (pictorial hazard alerts) in accordance with ANSI Z-535.3 and ISO 7010.

### Signal Words

Four signal words are used in this documentation: **DANGER**, **WARNING**, **CAUTION** and **NOTICE**.

The signal words **DANGER**, **WARNING** and **CAUTION** designate the degree or level of hazard when there is the risk of injury:

---

#### **DANGER!**

Indicates a hazardous situation that, if not avoided, will result in death or serious injury. This signal word is to be limited to the most extreme situations.

---

---

#### **WARNING!**

Indicates a hazardous situation that, if not avoided, could result in death or serious injury.

---

---

#### **CAUTION!**

Indicates a hazardous situation that, if not avoided, could result in minor or moderate injury.

---

The signal word “**NOTICE**” is used when there is the risk of property damage:

---

#### **NOTICE!**

Indicates information considered important, but not hazard-related.

---

Messages relating to hazards that could result in both personal injury and property damage are considered safety messages and not property damage messages.

## Symbols

The signal words **DANGER**, **WARNING**, and **CAUTION** are always emphasized with a safety symbol that indicates a special hazard, regardless of the hazard level:



---

**This symbol is intended to alert the operator to the presence of important operating and maintenance instructions.**

---



---

**This symbol is intended to alert the operator to the danger of exposure to hazardous visible and invisible laser radiation.**

---



---

**This symbol is intended to alert the operator to the presence of dangerous voltages within the product enclosure that may be of sufficient magnitude to constitute a risk of electric shock.**

---



---

**This symbol is intended to alert the operator to the danger of Electro-Static Discharge (ESD) susceptibility.**

---



---

**This symbol is intended to alert the operator to the danger of crushing injury.**

---



---

**This symbol is intended to alert the operator to the danger of a lifting hazard.**

---

## Preface

This manual presents user information for the Coherent EnergyMax™ meterless energy sensors.

---

**For complete software installation instructions, refer to the *EnergyMax-USB/RS Software Installation and Quick Start Guide (1186241)*—inside the CD case that shipped with your product.**

---

## Export Control Laws Compliance

It is the policy of Coherent to comply strictly with U.S. export control laws.

Export and re-export of lasers manufactured by Coherent are subject to U.S. Export Administration Regulations, which are administered by the Commerce Department. In addition, shipments of certain components are regulated by the State Department under the International Traffic in Arms Regulations.

The applicable restrictions vary depending on the specific product involved and its destination. In some cases, U.S. law requires that U.S. Government approval be obtained prior to resale, export or re-export of certain articles. When there is uncertainty about the obligations imposed by U.S. law, clarification must be obtained from Coherent or an appropriate U.S. Government agency.

Products manufactured in the European Union, Singapore, Malaysia, Thailand: These commodities, technology, or software are subject to local export regulations and local laws. Diversion contrary to local law is prohibited. The use, sale, re-export, or re-transfer directly or indirectly in any prohibited activities are strictly prohibited.

## Publication Updates

To view information that may have been added or changed since this publication went to print, connect to: [www.Coherent.com](http://www.Coherent.com).

## Unpacking and Inspection

All components of the Coherent EnergyMax-USB/RS sensor system are carefully tested and inspected before shipment.



---

### **NOTICE!**

**Save the inner container to store the components when not in use and to send the components to Coherent for calibration.**

---

Inspect each of the following items for damage:

- The EnergyMax sensor
- Post and stand components—refer to “Post and Stand Assembly,” below.
- Damage test slide (only included with sensors that do not have a built-in diffuser window)
- Heatsink, if ordered (optional accessory)

Advise Coherent immediately of any shortages or damage—refer to “Obtaining Service” (p. 7-5). A Returned Material Authorization (RMA) will be issued for any damaged sensor—refer to “Product Shipping Instructions” (p. 7-6).

## Post and Stand Assembly

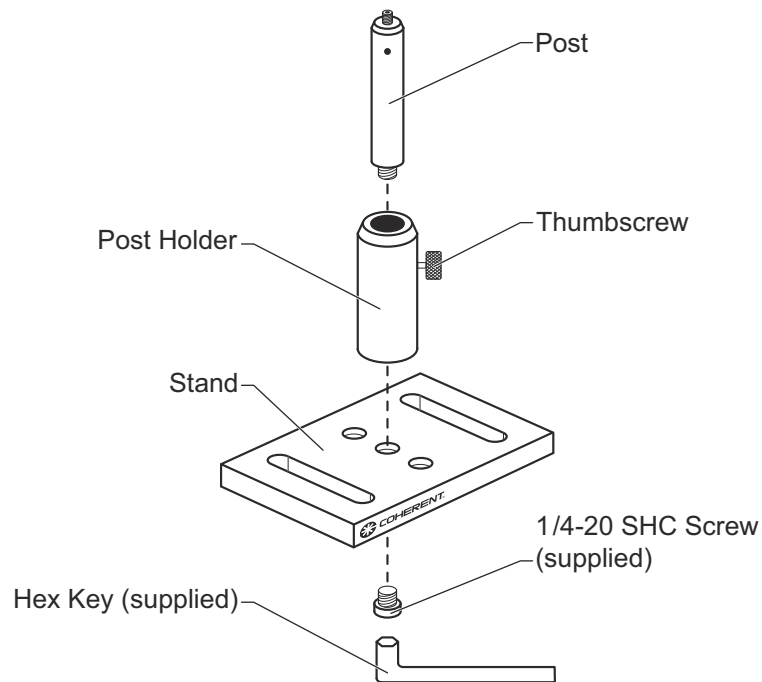

# SAFETY

Carefully review the following safety information to prevent personal injury and to prevent damage to this product or any equipment connected to it. There are no user-serviceable parts in Coherent EnergyMax sensors. For service information, refer to “Obtaining Service” (p. 7-5).



---

**WARNING!**

**Do not operate the system if its panels are removed or any of the internal circuitry is exposed.**

---



---

**WARNING!**

**Do not operate the system in wet or damp conditions, or in an explosive environment.**

---



---

**NOTICE!**

**Do not operate the system if there are suspected failures. Refer damaged units to qualified Coherent service personnel.**

---

## ***Environmental Regulations***

### **RoHS Compliance**

These Coherent products are RoHS (EU Restriction of Hazardous Substances) compliant.

### **Waste Electrical and Electronic Equipment (WEEE, 2002)**

The European Waste Electrical and Electronic Equipment (WEEE) Directive (2002/96/EC) is represented by a crossed-out garbage container label (Figure 1-1, below). The purpose of this directive is to minimize the disposal of WEEE as unsorted municipal waste and to facilitate its separate collection.

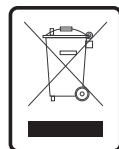

*Figure 1-1. Waste Electrical and Electronic Equipment Label*

**Declaration of  
Conformity**

Declaration of Conformity certificates are available upon request.

# DESCRIPTION

In this section:

- Introduction (this page)
- Product overview (p. 2-2)
- Sensor overview (p. 2-3)
  - MaxBlack EnergyMax sensors (p. 2-4)
  - Diffuse Metallic EnergyMax sensors (p. 2-5)
  - MaxBlack EnergyMax sensors with diffusers (p. 2-6)
  - MaxUV EnergyMax sensors (p. 2-7)
  - Quantum EnergyMax sensor (p. 2-8)

## Introduction

EnergyMax-USB/RS sensors have miniaturized meter electronics that are integrated *within* the sensor cable. The entire range of Coherent high performance EnergyMax sensors is available in this form factor with either RS-232 or USB 2.0 connectivity, enabling the measurement of the energy per pulse or average power of pulsed lasers from the nanojoule to the multi-joule level, over wavelengths from the deep ultraviolet through the far infrared, and from single pulses to repetition rates of 10 kHz (with measurement of every pulse). Multiple EnergyMax sensors can share a trigger (internal or external) for synchronized operation, for example to enable pulse radiometry.

Furthermore, EnergyMax USB/RS sensors significantly decrease the overall cost of ownership by removing the need to purchase a separate, more costly meter with each sensor, and by decreasing annual calibration costs related to integrating the electronics into the sensor. These products are also useful in the lab and research setting because they can be used as standalone instruments with a computer, or integrated smoothly into any experiment with an automated control and data acquisition system.

These meterless sensors are particularly attractive to system builders because their small size permits them to be easily embedded within instrumentation, and their RS-232 or USB communications capabilities facilitate automated operation by a host computer.



Coherent EnergyMax PC application software provides a virtual instrument interface for sensors that enable the operator to take laser energy readings, log data, and compute measurement statistics. Users can also write their own software using host interface commands that control all aspects of energy meter operation.

## **Product Overview**

### **Product Features**

- Able to measure every pulse up to 10 kHz and stream this data over the host port (USB only). RS-232 capable of measuring every pulse up to 10 KHz and streaming data over host port at a rate of 1 kHz.
- EnergyMax-USB provides direct USB high-speed 2.0 connection to PC. Power provided via USB connection.
- EnergyMax-RS provides RS-232 connectivity. Power input provided via +4-to-20 VDC input.
- Fast 14-bit A/D converter supports measurement accuracy similar to that found in LabMax-TOP meter.
- Up to five digits of measurement resolution.
- Each sensor incorporates a unique spectral compensation curve for accurate use at wavelengths that differ from the calibration wavelength.
- External and internal triggering available.
- Units can share triggers to provide synchronized measurements for applications, such as ratiometry.



## Software Features

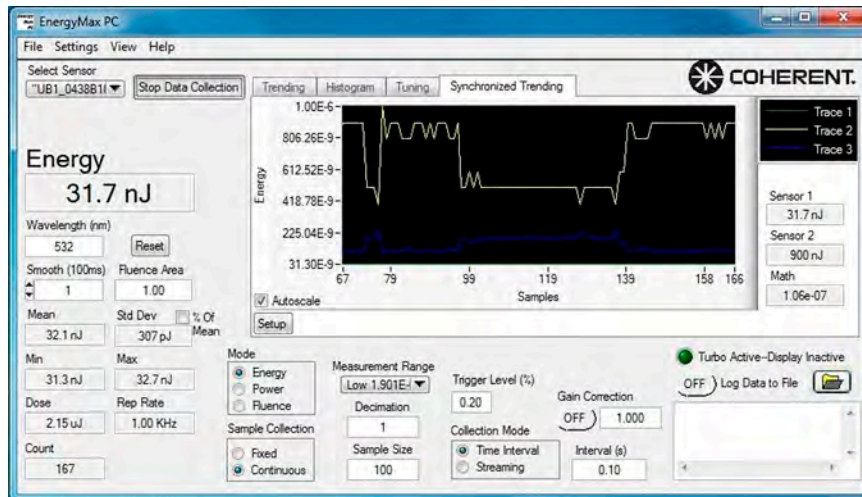

EnergyMax PC applications software is supplied free with every EnergyMax sensor and includes the following features:

- Trending, tuning, histogram at data rate up to 1 kHz.
- Statistics (mean, minimum, maximum, and standard deviation, dose, fluence, and missed pulses).
- Ability to log data to a file at up to 10 kHz (in Turbo mode).
- Operate multiple devices simultaneously and perform synchronized ratiometry (A/B analysis). Trend and log results to file.

For system integration and for implementations involving customer written software, EnergyMax sensors provide an in-depth command set that is easy to access:

- USB sensors connect on Virtual COM port, thus supporting simple ASCII host commands communication for remote interfacing.
- National Instruments™ LabVIEW™ drivers are supplied for easy LabVIEW integration.

## Sensor Overview

Coherent EnergyMax sensors are known as “smart” sensors—that is, they incorporate onboard electronics that automatically correct for pyroelectric sensor temperature, as well as built-in wavelength compensation factors.

This section gives an overview of each of the five types of sensors that comprise the EnergyMax Family: MaxBlack, Diffuse Metallic, MaxBlack With Diffusers, MaxUV, and Quantum.

## MaxBlack EnergyMax Sensors



The MaxBlack EnergyMax series has six different models that permit measurement over a wide range of wavelengths, beam diameters, average power levels, and repetition rates. All MaxBlack EnergyMax sensors feature the MaxBlack coating, which offers significantly better damage resistance and mechanical durability characteristics compared to black paint coatings.

The 25 and 50 mm diameter sensors accept a user-installable, optional heatsink—refer to “Increasing Average Power With Heatsinks” (p. 3-1)—which can extend the energy and/or repetition rate range. These heatsinks allow 25 mm sensors to be used up to 15W average power, and 50 mm sensors to be used up to 24W average power.



**NOTICE!**

**Use of EnergyMax sensors at average power levels beyond the base model average power specification—without the optional heatsink—can cause permanent damage to the sensor.**

**Table 2-1. MaxBlack EnergyMax Sensor Specifications**

	J-50MB-HE	J-50MB-LE	J-25MB-HE	J-25MB-LE	J-10MB-HE	J-10MB-LE
Energy Range	1.6 mJ to 2J	400 μJ to 500 mJ	850 μJ to 1J	50 μJ to 50 mJ	12 μJ to 20 mJ	500 nJ to 600 μJ
Noise Equivalent Energy	< 160 μJ	< 40 μJ	< 85 μJ	< 5 μJ	< 1.2 μJ	< 50 nJ
Wavelength Range (μm)	0.19 to 12					
Active Area Diameter (mm)	50	50	25	25	10	10
Max. Avg. Power (W)	10	10	5	5	4	4
Max. Pulse Width (μs)	57			17		
Max. Rep. Rate (pps)	300			1000		
Max. Energy Density (mJ/cm <sup>2</sup> )	500 (at 1064 nm, 10 ns)					
Sensor Coating	MaxBlack					
Diffuser	No					
Calibration Wavelength (nm)	1064					
Calibration Uncertainty (%)	± 2					
Energy Linearity (%)	± 3					
Cable Length (m)	3 (sensor cable) 1 (USB/RS cable)					
Cable Type	USB and RS					
Item Number						
USB	1191444	1191443	1191442	1191441	1191436	1191435
RS	1191432	-	-	1191431	1191429	1191428

## Diffuse Metallic EnergyMax Sensors



Diffuse Metallic EnergyMax sensors feature broad wavelength coverage (190 nm to 2.1  $\mu\text{m}$ ) and large active area (up to 50 mm).

This series of EnergyMax sensors has three different models that allow measurement over a wide range of wavelengths, beam diameters, average power levels, and repetition rates. These sensors feature a unique diffused metallic coating which offers significantly higher damage resistance than traditional metallic coatings and causes very little specular reflectance, thus eliminating spurious beams that can re-enter the laser cavity.

The 25 mm and 50 mm sensors accept a user-installable, optional heatsink—refer to “Increasing Average Power With Heatsinks” (p. 3-1)—which can extend the energy and/or repetition rate range. These heatsinks allow the J-25MT-10KHZ to be used up to 30W average power, and J-50MT-10KHZ to be used up to 50W average power.



### **NOTICE!**

**Use of EnergyMax sensors at average power levels beyond the base model average power specification—without the optional heatsink—can cause permanent damage to the sensor.**

**Table 2-2. Diffuse Metallic EnergyMax Sensor Specifications**

	<b>J-50MT-10KHZ</b>	<b>J-25MT-10KHZ</b>	<b>J-10MT-10KHZ</b>
Energy Range	400 $\mu\text{J}$ to 1J	90 $\mu\text{J}$ to 100 mJ	300 nJ to 200 $\mu\text{J}$
Noise Equivalent Energy	< 40 $\mu\text{J}$	< 9 $\mu\text{J}$	< 30 nJ
Wavelength Range ( $\mu\text{m}$ )	0.19 to 2.1		
Active Area Diameter (mm)	50	25	10
Max. Avg. Power (W)	20	10	1
Max. Pulse Width ( $\mu\text{s}$ )	1.7		
Max. Rep. Rate (pps)	10,000		
Max. Energy Density ( $\text{mJ}/\text{cm}^2$ )	500 (at 1064 nm, 10 ns)		50 (@ 1064 nm, 10 ns)
Sensor Coating	Diffuse Metallic		
Diffuser	No		
Calibration Wavelength (nm)	1064		
Calibration Uncertainty (%)	$\pm 2$		
Energy Linearity (%)	$\pm 3$		
Cable Length (m)	3 (sensor cable) 1 (USB/RS cable)		
Cable Type	USB and RS		
Item Number			
USB	1191417	1191446	1191445
RS	1191433	-	-

## MaxBlack EnergyMax Sensors With Diffusers



These sensors are specifically designed for high energy and high peak power lasers operating at relatively low repetition rates, such as those based on Nd:YAG, Ruby, Ho:YAG, and Erbium. The J-50MB-YAG sensor can be used with beams up to 35 mm in diameter and can work at 1064 nm, 532 nm, 355 nm, and 266 nm without the need to change or self-calibrate diffusers or any other accessories. Both sensors combine a MaxBlack coating and a diffuser to produce superior damage resistance characteristics. This combination enables operation with lasers that produce either very high energy per pulse or very high peak fluences.



---

**NOTICE!**

**Use of EnergyMax sensors at average power levels beyond the base model average power specification—without the optional heatsink—can cause permanent damage to the sensor.**

---

**Table 2-3. MaxBlack EnergyMax Sensor With Diffusers Specifications**

	<b>J-50MB-YAG</b>	<b>J-50MB-IR</b>
Energy Range	2.4 mJ to 3J <sup>a</sup>	3.2 mJ to 3J
Noise Equivalent Energy (μJ)	< 240	< 320
Wavelength Range (μm)	0.266 to 2.1	0.5 to 3.0
Max. Beam Size (mm)	35	30
Max. Avg. Power (W)	20	15
Max. Pulse Width (μs)	340	1000
Max. Rep. Rate (pps)	50	30
Max. Energy Density (J/cm <sup>2</sup> )	14.0 (at 1064 nm, 10 ns) 2.8 (at 532 nm, 10 ns) 0.75 (at 355 nm, 10 ns) 1.0 (at 266 nm, 10 ns)	> 100 (at 2940 nm, 100 μs)
Sensor Coating	MaxBlack	
Diffuser	YAG	IR
Calibration Wavelength (nm)	1064	1064, 2940
Calibration Uncertainty (%)	± 2	
Energy Linearity (%)	± 3	± 3.5
Cable Length (m)	3 (sensor cable) 1 (USB/RS cable)	
Cable Type	USB and RS	
Item Number		
USB	1191437	1191440
RS	1191430	-

a. Modified sensors with higher repetition rate, energy range, and/or pulse width are available. Contact Coherent.

## MaxUV EnergyMax Sensors



These sensors are specifically optimized for use with ArF lasers operating at 193 nm and KrF lasers operating at 248 nm, and feature high accuracy and large active areas (up to 50 mm). The EnergyMax series uses a unique coating—called MaxUV—that delivers superior long-term damage resistance.

Two of the 50 mm diameter models (labeled as “with Diffuser” in the model name) incorporate a DUV quartz diffuser for increased coating damage resistance.

Both sensors accept an user-installable, optional heatsink—refer to “Increasing Average Power With Heatsinks” (p. 3-1)—which can increase the maximum energy or average power range. These heatsinks allow 25 mm sensors to be used up to 18W average power, and 50 mm sensors to be used up to 43W average power (both at 193 nm).



---

### **NOTICE!**

**Use of EnergyMax sensors at average power levels beyond the base model average power specification—without the optional heatsink—can cause permanent damage to the sensor.**

---

*Table 2-4. MaxUV EnergyMax Sensor Specifications*

	<b>J-50MUV-248 (W/DIFFUSER)</b>	<b>J-25MUV-193 (W/O DIFFUSER)</b>
Energy Range	800 $\mu$ J to 1J	90 $\mu$ J to 100 mJ
Noise Equivalent Energy ( $\mu$ J)	< 80	< 9
Wavelength Range ( $\mu$ m)	0.19 to 0.266	0.19 to 2.1
Active Area Diameter (mm)	50	25
Max. Average Power (W)	15	5
Max. Pulse Width ( $\mu$ s)	86	43
Max. Rep. Rate (pps)	200	400
Max. Energy Density ( $\text{mJ}/\text{cm}^2$ )	520 (@ 248 nm, 10 ns)	200 (@ 193 nm, 10 ns)
Sensor Coating	MaxUV	
Diffuser	DUV	No
Calibration Wavelength (nm)	248	193
Calibration Uncertainty (%)	$\pm 3$	
Energy Linearity (%)	$\pm 3$	
Cable Length (m)	3 (sensor cable) 1 (USB/RS cable)	
Cable Type	USB	
Item Number		
USB	1191449	1191448

## Quantum EnergyMax Sensor



The Quantum EnergyMax sensor incorporates a Silicon photodiode, has a large 10 mm clear aperture, and operates at a repetition rate from single pulse up to 10 kHz (every pulse).

The main difference between a Quantum EnergyMax sensor and other Coherent EnergyMax sensors is its sensitivity. A Quantum EnergyMax sensor can measure much smaller signals than the rest of the EnergyMax sensor line because it uses a photodiode—rather than a pyroelectric—element.

Due to the *quantum* nature of their response, photodiode sensors are inherently more sensitive than pyroelectric sensors, which are thermal-based. One consequence of this extra sensitivity is the possibility of measurement error or noise from stray modulated light sources (for example, stray reflections or room lights) in a laboratory environment. For this reason Quantum EnergyMax sensors are designed for use with a small integrated input beam tube, which limits the field of view of the sensor aperture. This tube is removable for alignment purposes and custom applications.

The following chart plots the minimum and maximum measurable energy across all wavelengths. This chart can be used to find the measurable energy range for wavelengths different from that in the specifications table (532 nm).

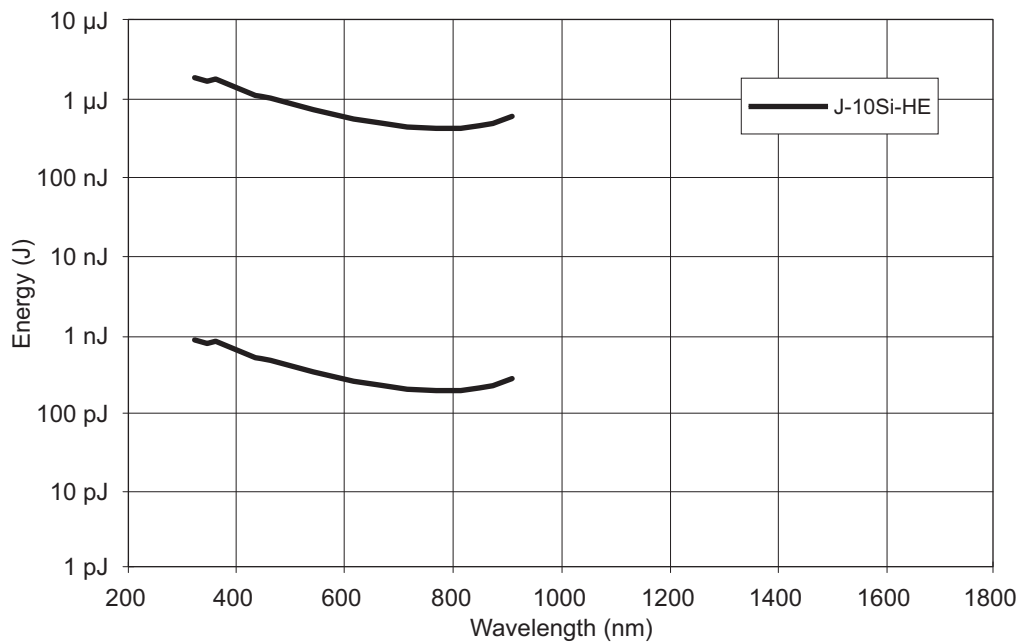

**Figure 2-1. Spectral Sensitivity Curves for Quantum EnergyMax Sensor**

The output of the Silicon and Germanium photodiodes used in the Quantum EnergyMax sensors varies greatly by wavelength. The sensors have spectral compensation to account for this varia-

tion—refer to “Spectral Response” (p. 3-5)—so that measurements are still accurate when used at wavelengths different from the calibration wavelength.

**Table 2-5. Quantum EnergyMax Sensor Specifications**

	<b>J-10SI-HE</b>
Energy Range	750 pJ to 775 nJ (at 532 nm)
Noise Equivalent Energy	< 75 pJ (at 532 nm)
Wavelength Range (nm)	325 to 900
Active Area Diameter (mm)	10
Max. Avg. Power (mW)	60
Max. Pulse Width (μs)	1
Max. Rep. Rate (pps)	10000
Sensor	Silicon
Diffuser	ND <sub>2</sub>
Calibration Wavelength (nm)	532
Calibration Uncertainty (%)	± 3
Linearity (%)	± 3
Cable Length (m)	3 (sensor cable) 1 (USB/RS cable)
Cable Type	USB and RS
Item Number	
USB	1191434
RS	1191427





# TECHNICAL DESCRIPTION

In this section:

- Increasing average power with heatsinks (this page)
- Pyroelectric technology (p. 3-2)
- Damage thresholds (p. 3-3)
- Measurement linearity (p. 3-4)
- Spectral response (p. 3-5)

## Increasing Average Power With Heatsinks



Using a heatsink increases the average power handling capability of EnergyMax sensors. These power levels are done by combining active temperature compensation circuitry and enhanced thermal management techniques. Maximum average power is wavelength dependent because absorption changes with wavelength. Maximum average power is inversely proportional to the spectral absorption.

The 25 mm and 50 mm aperture sensors accept optional heatsinks that users can install by mounting them on the back of the sensor. The heatsinks expand the average power handling capability as outlined below. Average power specification is dependent on coating and wavelength. Table 3-1 (p. 3-2) shows average power ratings for several wavelength and sensor combinations. Note that 10 mm aperture sensors do not accept heatsinks, 25 mm aperture sensors accept small and medium heatsinks, and 50 mm aperture sensors accept large heatsinks.



---

### **NOTICE!**

**Use of EnergyMax sensors at average power levels beyond the base model average power specification—without the optional heatsink—can cause permanent damage to the sensor.**

---

**Table 3-1. Average Power Ratings<sup>a</sup>**

Model	Wavelength (nm)	Heatsink			
		None	Small	Medium	Large
J-50MB-HE <sup>b</sup> & LE <sup>2</sup>	1064	10W	-	-	24W
J-25MB-HE <sup>c</sup> & LE <sup>3</sup>	1064	5W	10W	15W	-
J-10MB-HE <sup>d</sup> & LE <sup>4</sup>	1064	4W	-	-	-
J-50MT-10KHZ <sup>2</sup>	1064	20W	-	-	49W
J-25MT-10KHZ <sup>3</sup>	1064	10W	20W	31W	-
J-10MT-10KHZ <sup>4</sup>	1064	1W	-	-	-
J-50MB-YAG <sup>2</sup>	1064	20W	-	-	48W
J-50MB-IR	1064, 2940	15W	-	-	-
J-50MUV-248 <sup>2</sup> w/o Diffuser	248	10W	-	-	25W
J-25MUV-193 <sup>3</sup>	193	5W	10W	15W	-

- a. Average power ratings are based upon testing at the listed wavelength (not applicable for Quantum EnergyMax sensors).
- b. 50 mm EnergyMax sensors are compatible with the large heatsink.
- c. 25 mm EnergyMax sensors are compatible with small and medium heatsinks.
- d. 10 mm EnergyMax sensors do not have a heatsink available.

Table 3-2, below, lists the different heatsinks that are available for EnergyMax sensors.

**Table 3-2. Available Heatsinks**

Item Number	Name	Description
1123430	Small heatsink	Increases average power handling on 25 mm aperture EnergyMax sensors
1123431	Medium heatsink	
1123432	Large heatsink	Increases average power handling on 50 mm aperture EnergyMax sensors

## Pyroelectric Technology

Different from all other thermal sensors, pyroelectrics measure the rate of change of the sensor temperature, rather than the temperature value itself. As a result, the response speed of the pyroelectric is usually limited by its electrical circuit design and the thermal resistance of the absorptive coating. In contrast, other thermal sensors (for example thermopiles and bolometers) are limited by slower thermal response speeds, typically on the order of seconds. Pyroelectrics respond only to changing radiation that is chopped, pulsed, or otherwise modulated, so they ignore steady background radiation that is not changing with time. Their combination of wide uniform spectral response, sensitivity, and high speed make pyroelectrics ideal choices for a vast number of electro-optic applications.

The EnergyMax sensor line uses a pyroelectric element to measure the energy in a laser pulse. It does this by producing a large electrical charge for a small change in temperature. The active sensor circuit takes the current from the sensor element and converts it to a voltage that the instrument can measure.

Figure 3-1, below, shows the relationship between the current response of the pyroelectric element and the output voltage of the sensor circuit. The relationship between the current response and the output voltage response is fixed so the calibrated peak voltage of the output is the integrated energy of the laser pulse.

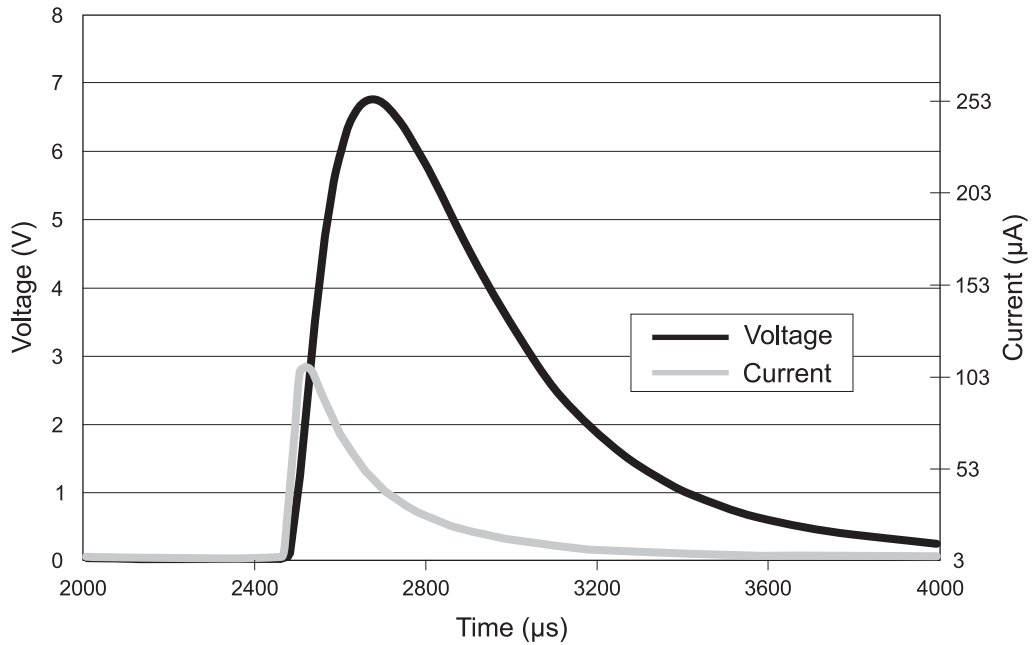

Figure 3-1. Pyroelectric Current and Voltage Response

## Damage Thresholds

The following table lists the damage threshold for different types of EnergyMax sensors at several wavelengths.

Table 3-3. EnergyMax Damage Thresholds Capabilities (Sheet 1 of 2)

Damage Threshold (mJ/cm <sup>2</sup> ) <sup>a</sup>						
Model	Wavelength (nm)					
	193	248	266	355	532	1064
J-50MB-HE	40	170	170	140	250	500
J-50MB-LE	40	170	170	140	250	500
J-25MB-HE	40	170	170	140	250	500
J-25MB-LE	40	170	170	140	250	500
J-10MB-HE	40	170	170	140	250	500

**Table 3-3. EnergyMax Damage Thresholds Capabilities (Sheet 2 of 2)**

Damage Threshold (mJ/cm <sup>2</sup> ) <sup>a</sup>						
	Wavelength (nm)					
J-10MB-LE	40	170	170	140	250	500
J-50MT-10KHZ	150	200	200	390	500	500
J-25MT-10KHZ	150	200	200	390	500	500
J-10MT-10KHZ	40	40	40	50	50	50
J-50MB-YAG	-	-	1000	750	2800	14000
J-50MUV-248 (w/diffuser)	400	520	520	-	-	-
J-25MUV-193	200	260	260	300	375	375

a. Not applicable for Quantum EnergyMax sensors.

### **Measurement Linearity**

Coherent has designed the EnergyMax sensor line to greatly decrease several linearity effects common in pyroelectric energy sensors. The outcome of this design effort is increased performance that is now better than at any time in the history of pyroelectric pulsed laser energy measurement.

### **Energy Linearity**

Energy linearity across the entire specified energy range of an EnergyMax sensor is +/- 3%. Within 10 to 90% of the energy range specification the sensors are typically linear to +/- 2%. (The J-50MB-IR has a slightly higher energy linearity specification of +/- 3.5%.)

### **Repetition Rate Linearity**

Repetition rate linearity is +/- 1%. In practice, the actual error is often much less than 1%.

### **Average Power Linearity**

The pyroelectric crystal is sensitive to temperature at a rate of approximately 0.2% per degree Celsius change in temperature. Historically this has limited the average power to which a sensor can be exposed. This circuit permits measurement of higher pulse energy at faster repetition rates than ever before and enables the use of removable heatsinks.

EnergyMax sensors have less than 2% error when used at maximum average power, and have less than 0.5% undershoot when hit with the full power rating. In practice, many EnergyMax sensors have typical average power linearity error of less than 1%.

## Temperature Linearity of Quantum EnergyMax Sensors

The Silicon Quantum EnergyMax sensor (J-10SI-HE) has a temperature linearity component because of a photo sensitivity temperature characteristic that varies by wavelength, as shown in the figure below. In practice, the error is less than 1%, unless the sensors are used in a very hot environment. To calculate  $\Delta^{\circ}\text{C}$ , compare the temperature of the environment within which the sensor is being used, to the calibration temperature. Add 1 to 2 $^{\circ}\text{C}$  for sensor electronics.

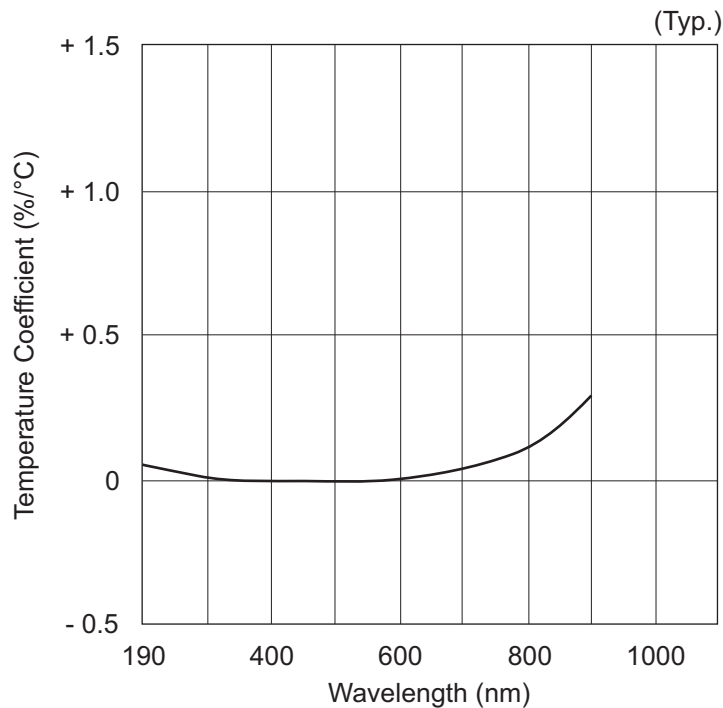

Figure 3-2. Photo Sensitivity Temperature Characteristics

## Pulse Width Linearity

There is a small amount of pulse width linearity error when using a sensor at its maximum specified pulse width. This error is less than 1%. At pulse widths less than 10  $\mu\text{s}$  this error is negligible and is less than 0.5%. (The J-50MB-IR sensor has a slightly higher pulse width linearity specification of +/- 1.5%.)

## Spectral Response

All pyroelectric EnergyMax sensors incorporate a diffuse coating to minimize specular reflections, which eliminates spurious beams that can re-enter the laser cavity.

In addition, all EnergyMax sensors include the convenience of onboard electronics that have built-in wavelength compensation factors. Enter the wavelength of the laser being measured within the PowerMax PC software (or by a host command) and the sensor

output will be automatically compensated. Wavelength compensation results in an additional error factor when engaged and when the sensor is being used at a wavelength different from the wavelength at which it was calibrated. The accuracy is based upon the sensor coating.

### Applying Wavelength Compensation Accuracy

Overall measurement accuracy is a combination of calibration uncertainty (found in the sensor specification tables) and the wavelength compensation accuracy—refer to Table 3-4, below.

The combined accuracy is based upon practices outlined in the National Institute of Standards Guidelines for Evaluating and Expressing Uncertainty (NIST Technical Note 1297, 1994 Edition). The combined accuracy of the measurement is calculated by using the law of propagation of uncertainty using the “root-sum-square” (square root of the sum of squares), sometimes described as *summing in quadrature*, where:

$$\text{Measurement Accuracy} = \sqrt{U^2 + W^2}$$

where U = 'Percent Calibration Uncertainty' and W = 'Wavelength Accuracy'

#### Example 1

J-10SI-HE used at 355 nm

$$U = 3\%$$

$$W = 5\%$$

$$\text{Measurement Accuracy} = \sqrt{3^2 + 5^2} = \sqrt{9 + 25} = 5.8\%$$

#### Example 2

J-10MB-LE used at 532 nm

$$U = 2\%$$

$$W = 2\%$$

$$\text{Measurement Accuracy} = \sqrt{2^2 + 2^2} = \sqrt{4 + 4} = 2.8\%$$

**Table 3-4. Wavelength Compensation Accuracy (Sheet 1 of 2)**

Sensor	Wavelength Compensation Accuracy (%) (for wavelengths other than the calibration wavelength)	Calibration Wavelength (nm)
All Multipurpose sensors (MaxBlack coating)	± 2%	1064 nm
All High Rep. Rate sensors (Diffuse metallic coating)	± 3%	
J-50MB-YAG	± 2%	
J-50MB-IR	± 3%	1064, 2940 nm

**Table 3-4. Wavelength Compensation Accuracy (Sheet 2 of 2)**

Sensor	Wavelength Compensation Accuracy (%) (for wavelengths other than the calibration wavelength)	Calibration Wavelength (nm)
J-25MUV-193	± 3%	193 nm
J-50MUV-248	± 4%	248 nm
J-10SI-HE	± 5%	532 nm

Figure 3-3, below, and Figure 3-4 (p. 3-8) plot the spectral characteristics of each sensor. Figure 3-3 plots the percent absorption of each coating by wavelength. Figure 3-4 plots—also by wavelength—the spectral sensitivity of sensors that have diffusers. The spectral sensitivity is a function of the transmission of the optic and the absorption of the coating, and is normalized to the calibration wavelength.

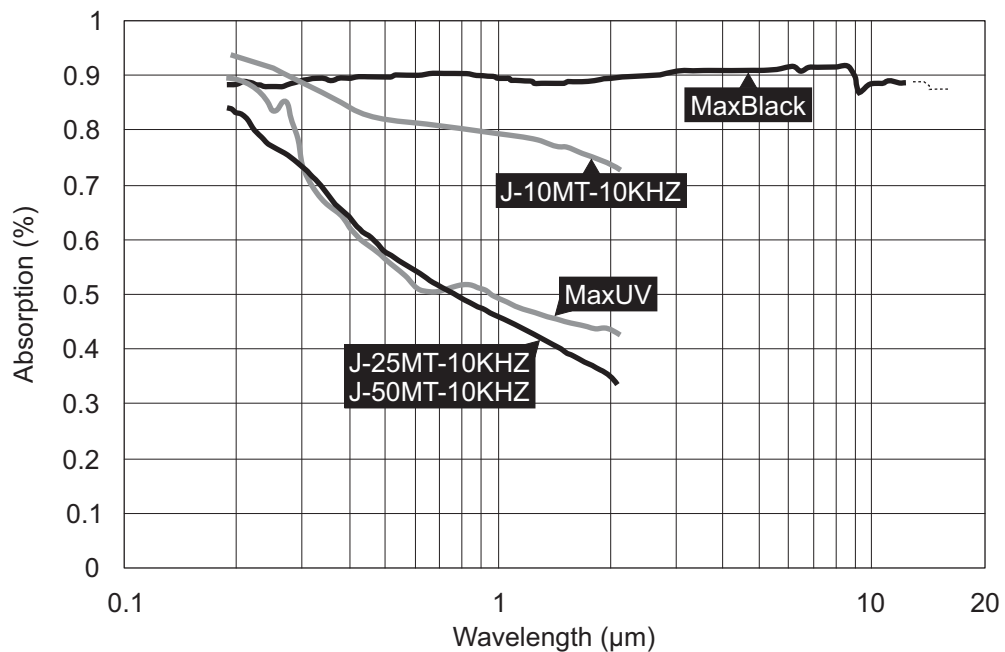

**Figure 3-3. Spectral Absorption of EnergyMax Sensor Coatings**

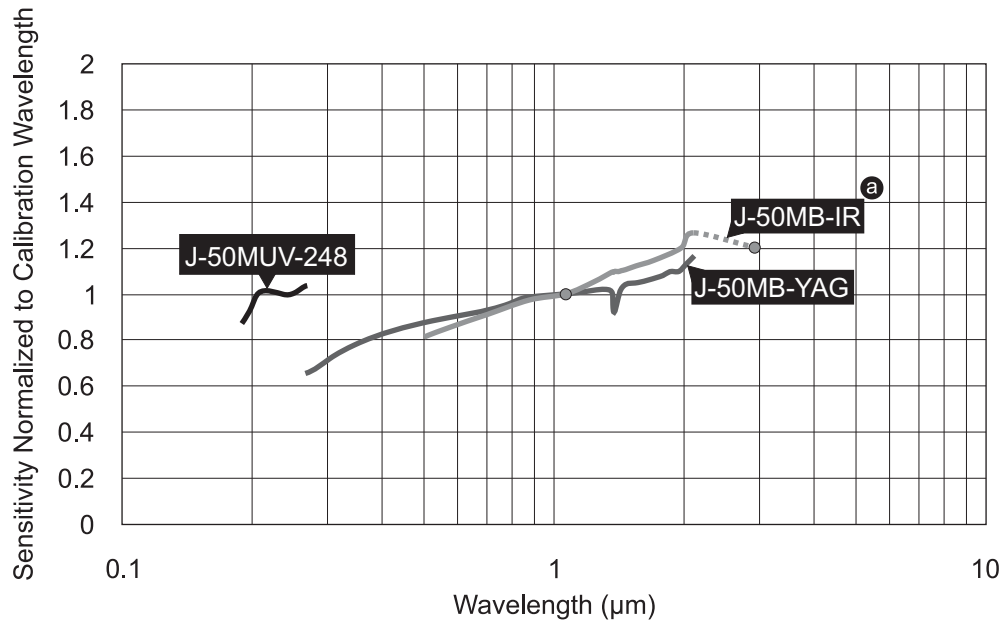

<sup>a</sup> The J-50MB-IR is calibrated at both 1064 and 2940 nm.

**Figure 3-4. Spectral Sensitivity of EnergyMax Sensors With Diffusers**



# OPERATION

In this section:

- LED status indicator (this page)
- Powering EnergyMax-RS sensors (p. 4-2)
- Pyroelectric Watts mode (p. 4-2)
- Triggering (p. 4-3)
- Internal Triggering mode (p. 4-3)
- Setting the wavelength (p. 4-4)
- Tutorial: Measuring energy With a EnergyMax sensor (p. 4-5)
- Tutorial: Synchronization (p. 4-7)
- Tutorial: Turbo mode (p. 4-12)
- Using the software (p. 4-14)

## LED Status Indicator

A blue LED light is contained within the EnergyMax-USB and EnergyMax-RS connectors to provide health-and-status information.

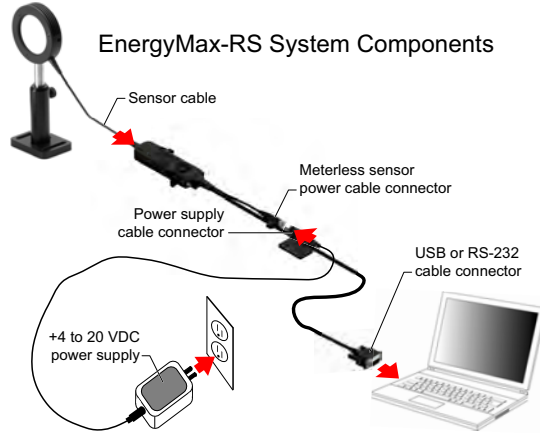

**Table 4-1. EnergyMax-USB/RS LED Light Conditions**

LED Light Condition	Status
No light visible	If the EnergyMax-USB sensor is connected to the PC—or, in the case of an EnergyMax-RS sensor, if it is connected to a power source—but there are no visible lights, the sensor is not powering up properly. Test the sensor on another USB port and if that does not solve the problem, contact Coherent for service—refer to Table 7-1 (p. 7-5) for contact information.
Light is on	Sensor is functioning.
Lights flashing	The LED flashes for 50 msec with each pulse measurement. At high repetition rates it may not appear to be flashing, but will appear brighter than when measurements are not occurring.

## Powering EnergyMax-RS Sensors

The EnergyMax-RS sensor is powered via a +4 to 20 VDC power supply input. This power can be applied with either an external power supply (not included), as shown below, or input through Pin 1 of the DB-9 connector. An optional external power supply can be ordered using part number 1105557.



## Pyroelectric Watts Mode

EnergyMax pyroelectric sensors can measure average power from a series of pulses. Selecting the power measurement mode will change the EnergyMax software to display and trend data based on average power readings.

Average power is calculated by measuring the energy of the pulses and dividing by the periods between them and, thus, requires at least two pulses to make a power measurement. Each subsequent pulse defines the period for the previous pulse until the last pulse (see figure, below). The last pulse in a pulse burst will not yield a power measurement since the period after the last pulse is indeterminate. This method permits more accurate tracking of initial average power transients for pulsed lasers.

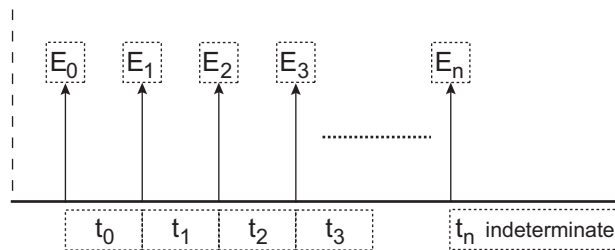

**Figure 4-1. Average Power Diagram**

When measuring the average power of a laser burst or continuous pulse train, the frequency of the pulses must be greater than or equal to 1 Hz, and less than or equal to the maximum repetition rate capa-

bility of the pyroelectric sensor. Multiple bursts separated by one second or less are treated as a single burst and, accordingly, the gap between bursts appears as a lower power.

---

**Short bursts with rep rates greater than 1 kHz may not yield a power measurement.**

---

## Triggering

EnergyMax sensors can be triggered externally via the Ext Trig connector. This is particularly useful in an electrically-noisy environment. EnergyMax sensors can be set to synchronize with either the positive or negative transition of this external signal.

When a reliable external trigger is not available, an EnergyMax sensor can be set to use its own internal circuitry to extract a trigger from the incoming signal. This is called *Internal Triggering* (discussed, below).

## Internal Triggering Mode

*Internal triggering* refers to finding a trigger automatically from the incoming signal.

The trigger level setting helps filter out low-level noise that can cause false triggering from the sensor. The trigger level is a percentage of the energy level listed for the measurement range that is currently selected. So if a measurement range of 50 mJ is selected in the software and a trigger level of 1% is entered, the trigger threshold will be 0.5 mJ. This means that any values above 0.5 mJ will be captured as a valid reading, and any values below 0.5 mJ will be ignored as noise. Using the combination of the measurement range selection and the trigger level setting can help the sensor accurately measure without picking up noise or false triggers in the readings.

In the following figure, the internal trigger threshold has been set to 8% (shown as a dashed line). Pulse **A** will definitely *not* generate a reliable trigger. Pulse **B** *may* generate a trigger, but not reliably. Pulses **C** and **D** *will* definitely generate reliable triggers.

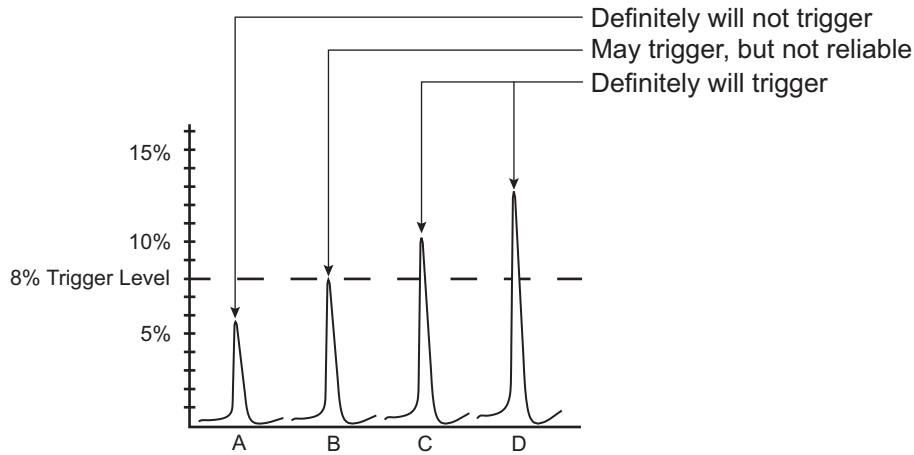

**Figure 4-2. Internal Trigger Threshold**

The trigger is synchronous with the leading edge of the pulse, but the actual peak is determined algorithmically by sampling the input signal near the trigger. From the trigger point forward, the algorithm searches for peaks and from the trigger point back, it searches for a baseline.

## Setting the Wavelength

The wavelength should always be set for accurate power measurements. This can be done either in the EnergyMax PC application software or over the host port via a host command.

## Tutorial: Measuring Energy With a EnergyMax Sensor

This tutorial describes how to connect a EnergyMax-USB or EnergyMax-RS sensor to your PC and start taking energy measurements using the EnergyMax PC software.



---

### WARNING!

Follow all laser safety procedures. The laser must be switched OFF or shuttered before running the tutorial given in this section.

---





---

### NOTICE!

For instructions on communicating with the sensor directly via host commands, refer to “Host Interface” (p. 6-1).

---

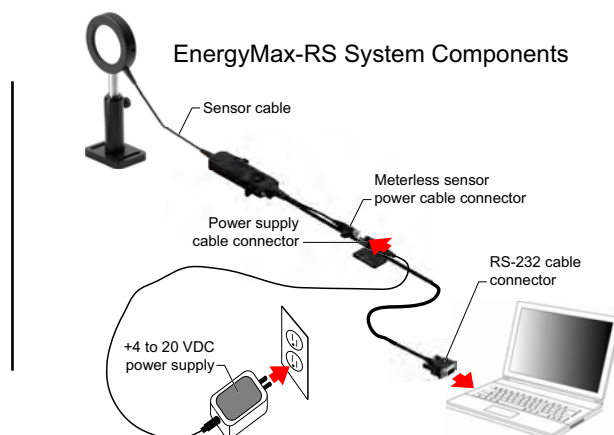
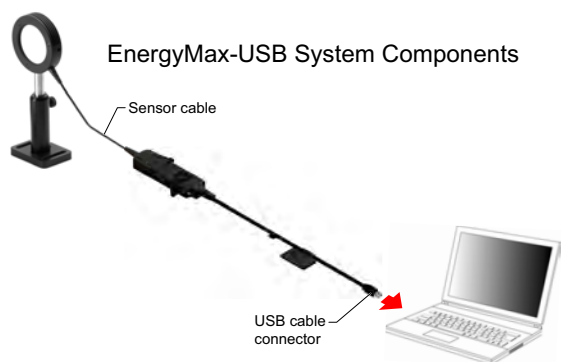
1. Install the EnergyMax PC software—for details, refer to the *EnergyMax-USB/RS Software Installation and Quick Start Guide* (1186241) that shipped with your system.
2. Connect the system components (the following figure shows system components for both EnergyMax-USB and EnergyMax-RS sensors—select the one that’s applicable for your system).



- 3. Confirm that the blue LED is lit.



- 4. Start the EnergyMax PC software.

- 5. (*EnergyMax-RS sensors only*) Click *Add a RS-232/Serial Port* on the Setting dropdown menu.

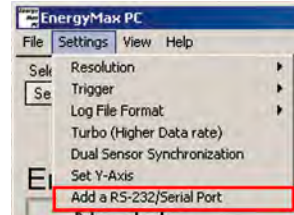

- 6. (*EnergyMax-RS sensors only*) On the Add Serial Sensor menu, select the *Com Port* and *Baud Rate* parameters and then click the OK button. Select the highest baud rate supported by the computer.

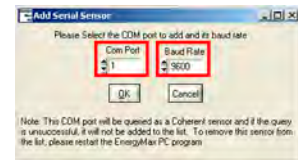

- 7. Select the sensor serial number from the Select Sensor dropdown menu. In the example at right, the selected sensor is *0438B10R*.

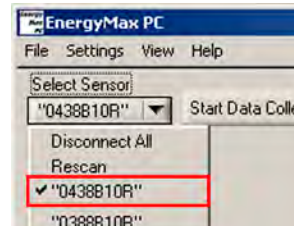

- 8. Press the Start Data Collection button and then turn ON the laser to start taking energy measurements.

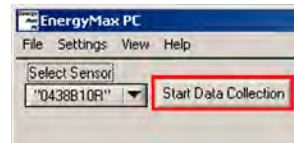

## Tutorial: Synchronization

EnergyMax-USB and EnergyMax-RS sensors can be synchronized for greater accuracy when performing A/B ratiometry measurements. The purpose of synchronization mode is to make sure that data being reported by multiple sensors is correlated sequentially when triggered by a common triggering event.

To do synchronization, EnergyMax-USB and -RS sensors are designed with the following features:

- The sensor units are stackable and automatically activate a common trigger bus when stacked together.
- The electronics module on the *bottom* of the module stack takes control of the trigger bus.
- Each measurement made during a trigger event is sequentially numbered.

## Procedure: Taking a Synchronized A/B Ratiometric Reading

This procedure describes how to connect two EnergyMax-USB or EnergyMax-RS sensors to your PC and take a synchronized A/B ratiometric reading using the EnergyMax PC software.





---

### WARNING!

**Follow all laser safety procedures. The lasers must be switched OFF or shuttered before running the procedure given in this section.**

---

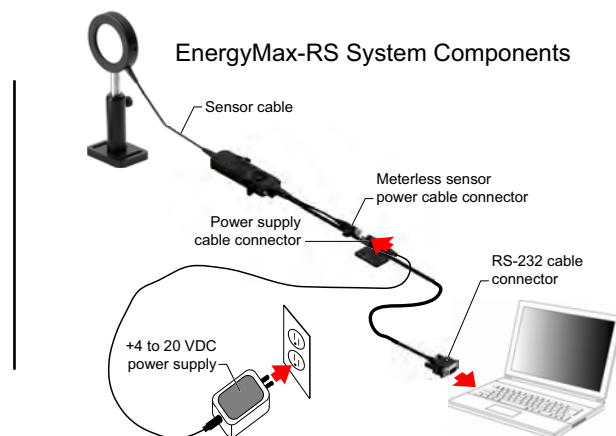
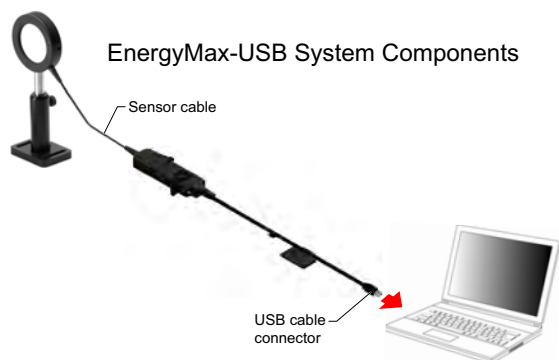
1. Connect the system components (the following figure shows system components for both EnergyMax-USB and EnergyMax-RS sensors—select the one that's applicable for your system).



2. Start the EnergyMax PC application.
3. (*EnergyMax-RS sensors only*) Click *Add a RS-232/Serial Port* on the Setting dropdown menu.

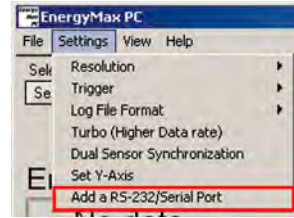

4. (*EnergyMax-RS sensors only*) On the Add Serial Sensor menu, select the *Com Port* and *Baud Rate* parameters and then click the OK button. Select the highest baud rate supported by the computer.

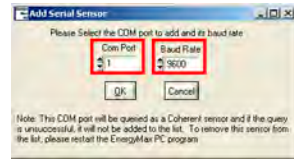

---

**Before you continue this procedure, make sure the sensors are not stacked.**

---



— Steps 5 through 9 verify that range and trigger threshold are independently working for each sensor, before synchronizing. —

5. Select the sensor serial number from the Select Sensor dropdown menu. In the example at right, the selected sensor is *0438B10R*.

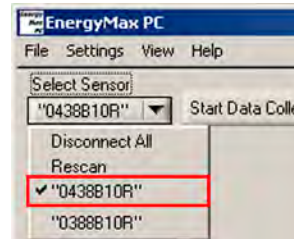

6. Press the Start Data Collection button and then turn ON the laser.



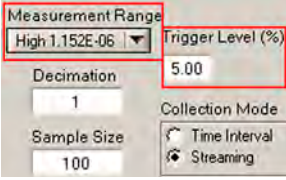

7. Select the applicable Measurement Range (*High* or *Low*) and adjust the Trigger Level to get a good measurement. For information on setting the trigger level, refer to “Internal Triggering Mode” (p. 4-3). 
8. Turn OFF the laser and confirm the sensor is not triggering on baseline noise. If it is triggering on baseline noise, increase the trigger level.
9. Repeat steps 5 through 8 for the *second* sensor and then continue to step 10, below.
10. Open the Select Sensor dropdown menu and select the “faster” sensor, that is, the sensor *with the fastest (higher) repetition rate specification*.
11. Stack the sensors together, with the “faster” sensor located on the bottom of the stack.



**NOTICE!**

The “faster” sensor must be on the *bottom* of the stack to properly trigger. Since the “faster” sensor gets a trigger first, it is important that this faster trigger be used to control the trigger bus.



12. Select *Dual Sensor Synchronization* from the Setting dropdown menu.

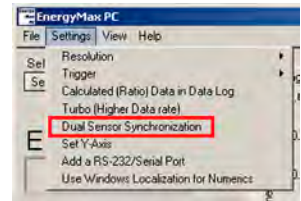

13. Select the Synchronized Trending tab.



14. Click the Setup button.



This will display the Sync Configuration Setup menu. The sensor selected in step 10, above (which is the *faster* of the two sensors), is automatically listed as *Sensor 1 (a)* in this setup panel and will subsequently be listed as the “Master” serial number in the Synchronized Trending chart.



15. Press the Select Sensor 2 button to display the Synch Configuration screen.



This will display the Synch Configuration screen.

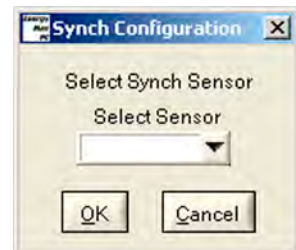

16. Pick the second (*slower*) sensor from the dropdown menu and then press the OK button to return to the Synch Configuration Setup screen.

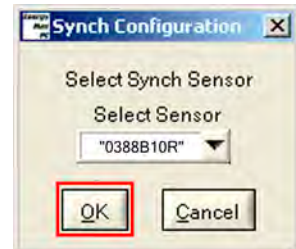

17. Enter the desired math operation (default is an A/B ratiometric calculation, which is shown in this example), and then click the OK button to complete setup.

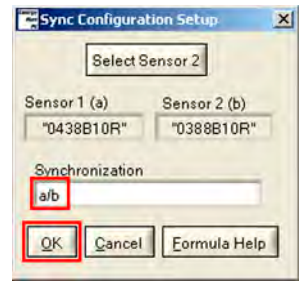

18. Press the Reset button in the Front panel.

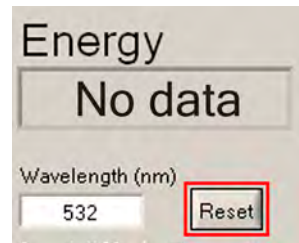

19. Click the Start Data Collection button and then turn ON the lasers.

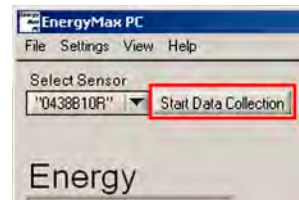

20. View the ratiometric data being trended.

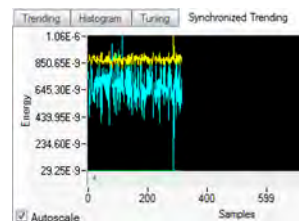

This data can be logged to a file using the Log Data to File dialog.

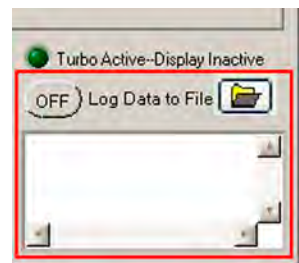

## Tutorial: Turbo Mode

At high repetition rates above approximately 1 to 2 kHz, the sensor can capture and measure every single pulse, as well as send data to the computer. Most dual-core and quad-core computers faster than 2 GHz can process the data and analyze every pulse—even at high repetition rates—using the full graphical and statistical features of the software. As the repetition rate increases, however, the software will eventually reach a point at which it can miss some of the pulses. When that occurs, there are two options:

1. Enter a Decimation factor (a decimation factor of 2 sends 1/2 of the data to the software, a decimation of 3 sends 1/3 of the data, and so on).
2. Enter Turbo mode to log all of the data to a file.

Turbo mode lets the user continue to collect data for every pulse and save it directly to a file at the fastest rate that the sensor will permit. This higher repetition rate logging capability is done by disabling the calculation and display elements of the software, including the live display, statistics and batch count, and plotting.

## Procedure: Using Turbo Mode

This tutorial describes how to use the Turbo mode within EnergyMax PC software.



---

### WARNING!

**Follow all laser safety procedures. The lasers must be switched OFF or shuttered before running the procedure given in this section.**

---

1. Connect the system components (the following figure shows system components for EnergyMax-USB).

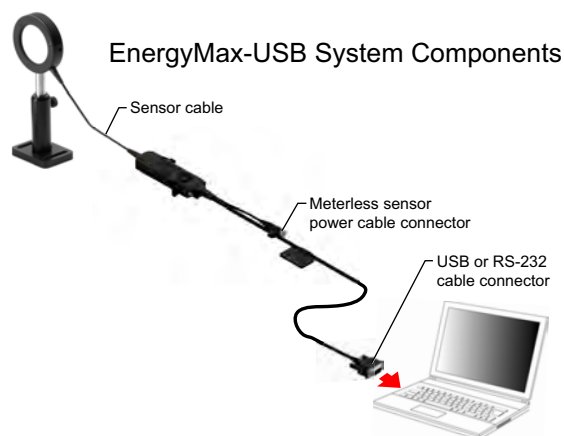

2. Start the EnergyMax PC application.
3. Select the sensor serial number from the Select Sensor dropdown menu. In the example at right, the selected sensor is *0438B10R*.

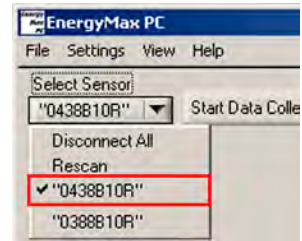

4. Select the applicable Measurement Range (*High* or *Low*) and adjust the Trigger Level to get a good measurement. For information on setting the trigger level, refer to “Internal Triggering Mode” (p. 4-3).

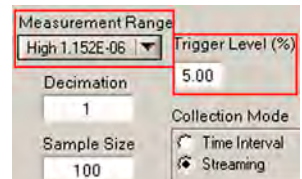

5. Click *Turbo* on the Setting dropdown menu.

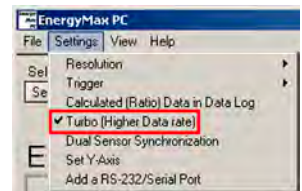

The *Turbo Active - Display Inactive* indicator light will turn green to indicate that the software is now in Turbo mode. Measured values will show “No data.”

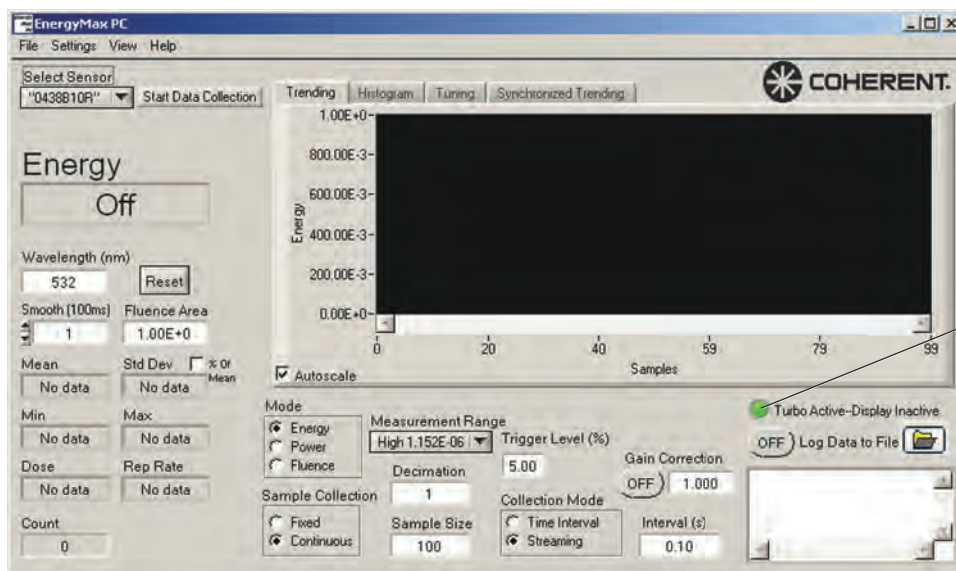

Turbo Indicator light

6. Press the Log Data to File folder icon.

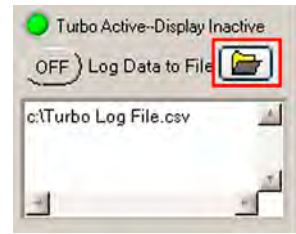

7. When the directory screen appears, select/enter a file name (with a .txt extension for tab delimited or .csv extension for comma delimited), and then press the OK button to dismiss the screen. In this example, the selected file is *Turbo Log File.csv*.

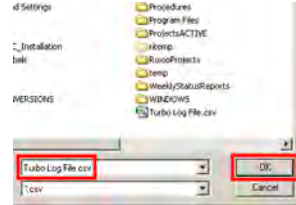

8. Click the OFF/ON button to turn ON data logging.

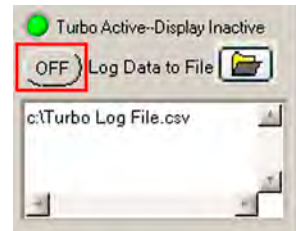

9. Click the Start Data Collection button and then turn ON the laser.



During data collection in Turbo mode, all of the pulses are saved to the log file and the *Turbo Active - Display Inactive* indicator blinks for every 500 pulses collected.

---

**All other front panel displays, including statistics, live display, batch counter, and the plot window, are inactive while Turbo mode is active.**

---

## Using the Software

For complete EnergyMax PC information, refer to the software help inside the application, or reference the EnergyMax PC Help file included on the CD.

# SPECIAL TOPICS

In this section:

- Understanding the external trigger circuit (this page)
- Extending cable length (p. 5-2)

## Understanding the External Trigger Circuit

To prevent ground loop noise from interfering with accurate measurement, the external trigger input is optically isolated from the EnergyMax internal ground by an optocoupler. The following figure shows a simplified schematic of the external trigger input circuitry.

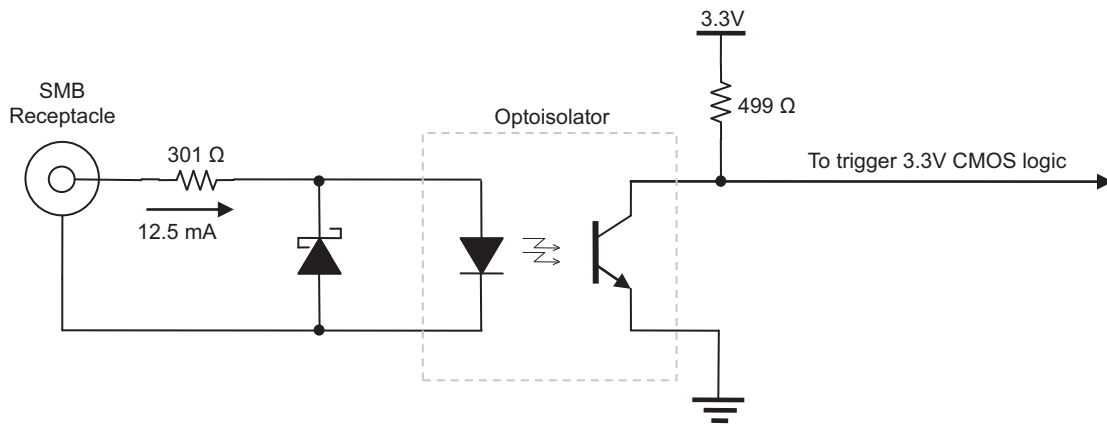

**Figure 5-1. External Trigger Input Circuitry**

To provide proper functionality of the circuit, the source of the external trigger pulse should meet the following requirements:

Logic: Active high or low. Select corresponding triggering edge using the TRIG:SLOP POS or TRG:SLOP NEG commands.

Level: 5V TTL or CMOS logic

Width:  $\geq 1 \mu\text{s}$

Load current:  $\geq 12.5 \text{ mA}$

## Extending Cable Length

*USB sensors:* The EnergyMax-USB cable is 3 meters in length from the sensor to the electronics module, and approximately 1 meter in length from the electronics module to the USB or RS-232 connector.

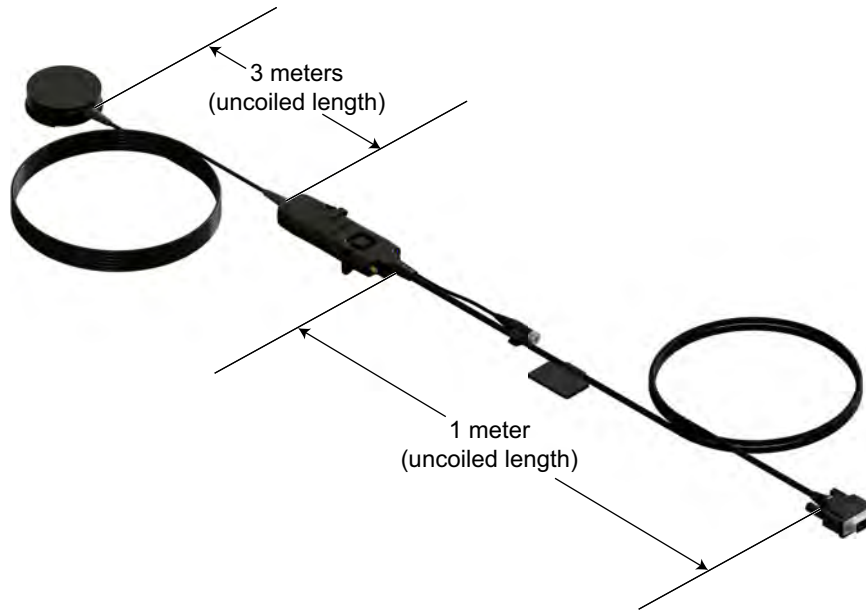

**Figure 5-2. EnergyMax-USB Standard Cable**

USB hubs can be employed to increase the length of the cable. The USB standard permits a maximum of five hubs—connected in series with 5-meter cables connecting the hubs—thus providing a maximum range of 27.5 meters.

There are also active 5-meter USB extension cables on the market that perform as if they were a USB hub, but for just a single USB sensor. (Contact Coherent for advice related to specific hubs we have tested in-house.)

*RS sensors:* Use a standard off-the-shelf RS-232 straight through extension cable to increase the length.



# HOST INTERFACE

In this section:

- Overview (this page)
- Message terminators (this page)
- Host command quick reference (p. 6-2)
- SCPI interface section (p. 6-4)
- Data streaming transmission interface section (p. 6-17)
- Operational parameters (p. 6-18)
- Host interface glossary (p. 6-18)

## Overview

This section defines the host interface of the EnergyMax-USB/RS meterless energy sensor, and includes high-level commands, responses, and behavior that a user or host computer can expect from the sensor. The low-level interface—which covers RS-232, USB, and other types of communication methods—is not presented in this section, except where it directly impacts the high-level interface.

## Message Terminators

Messages between the sensor and the host computer are comprised entirely of ASCII string characters, with the exception of the Data Streaming Transmission Interface, which sends unsolicited, uniquely coded out-of-band data transmissions. Strictly binary messages are not supported. All message strings passing through the host interface are terminated to signal the end of a message string.

## Messages Received by the Sensor

Messages received by the sensor must be terminated by a carriage return (decimal 13). Line feed characters (decimal 10) are discarded, so message terminator flexibility can be attained. A command or query is considered incomplete without the terminator. The maximum length of any message received by the sensor is limited to 200 bytes.

## Messages Sent by the Sensor

All messages sent by the sensor and defined in this section are terminated by a carriage return and line feed pair.

## Host Command Quick Reference

The following table gives a brief description of all host commands. For detailed information about a specific command, go to the page referenced in the right-hand column.

**Table 6-1. Host Command Quick Reference (Sheet 1 of 2)**

Command	Description	Page #
<b>SCPI INTERFACE</b>		
<i>SCPI Common Commands</i>		
*RST	Resets all operational parameters to their power-on states	6-4
*IDN?	Queries the sensor identification string	6-5
<i>System Options</i>		
SYSTem:REStore	Restores all user settings to the factory state	6-5
SYSTem:COMMunicate:HANDshaking	Selects the state of SCPI message roundtrip handshaking	6-5
SYSTem:COMMunicate:HANDshaking?	Queries the state of SCPI message roundtrip handshaking	6-5
SYSTem:COMMunicate:SERial:BAUD	Selects the transmit and receive baud rates together when the device has an RS-232 serial host port	6-6
SYSTem:COMMunicate:SERial:BAUD?	Queries the currently-selected baud rate	6-6
<i>Error Record Reporting and Collection</i>		
SYSTem:ERRor:COUNt?	Queries the number of error records in the error queue at the time of the query	6-7
SYSTem:ERRor:NEXt?	Queries the next error record(s) in the error queue	6-7
SYSTem:ERRor:ALL?	Queries all error records in the error queue at the time of the query	6-8
SYSTem:ERRor:CLear	Clears all error records in the error queue	6-8
<i>Measurement Setup and Control</i>		
CONFigure:MEASure:TYPE	Sets the meter measurement mode type	6-8
CONFigure:MEASure:TYPE?	Queries the meter measurement mode type	6-8
CONFigure:MEASure:STATistics	Sets the statistics processing mode	6-8
CONFigure:MEASure:STATistics?	Queries the statistics processing mode	6-8
CONFigure:DECimation	Sets the pulse decimation rate	6-9
CONFigure:DECimation?	Queries the pulse decimation rate	6-9
CONFigure:DIAMeter	Sets the aperture diameter	6-9
CONFigure:DIAMeter?	Queries the aperture diameter	6-9
CONFigure:WAVElength	Sets the current wavelength	6-9
CONFigure:WAVElength?	Queries the current wavelength	6-9
CONFigure:GAIN:COMPensation	Enables or disables gain compensation	6-10
CONFigure:GAIN:COMPensation?	Queries the gain compensation setting	6-10
CONFigure:GAIN:FACTor	Sets the gain compensation factor	6-10
CONFigure:GAIN:FACTor?	Queries current gain compensation factor	6-10
CONFigure:RANGe:SELect	Selects the meter measurement range	6-10
CONFigure:RANGe:SELect?	Queries the meter measurement range	6-10
<i>Statistics Mode Control</i>		

Table 6-1. Host Command Quick Reference (Sheet 2 of 2)

Command	Description	Page #
CONFigure:STATistics:BSIZE	Sets the statistics batch size	6-11
CONFigure:STATistics:BSIZE?	Queries the statistics batch size	6-11
CONFigure:STATistics:RMOde	Selects the action to be taken at the end of a statistical batch	6-11
CONFigure:STATistics:RMOde?	Queries the action to be taken at the end of a statistical batch	6-11
CONFigure:STATistics:STARt	Terminates the current statistical batch and start a new one	6-11
CONFigure:STATistics:STOP	Terminates the current statistical batch if a batch is in progress	6-11
<i>Trigger Parameters</i>		
TRIGger:SOURce	Selects the trigger source	6-12
TRIGger:LEVel	Sets the trigger level	6-12
TRIGger:LEVel?	Queries the trigger level	6-12
TRIGger:SLOPe	Selects the external trigger edge	6-12
TRIGger:SLOPe?	Queries the external trigger edge	6-12
TRIGger:DELay	Selects the external trigger delay time	6-12
TRIGger:DELay?	Queries the external trigger delay time	6-12
TRIGger:SEQuence	Sets the sequence ID	6-13
TRIGger:BUS:PMODE {BUS NBUS}	Sets the trigger bus participation mode	6-13
TRIGger:BUS:PMODE?	Queries the trigger bus participation mode	6-13
<i>Measurement Data Collection</i>		
CONFigure:ITEMselect	Selects the statistics mode of transmit data items	6-14
CONFigure:ITEMselect?	Queries the statistics mode of transmit data items	6-14
CONFigure:STATistics:ITEMselect	Selects the statistics mode of transmit data items	6-14
CONFigure:STATistics:ITEMselect?	Queries the statistics mode of transmit data items	6-14
READ?	Gets the last recorded measurement at the time of the query	6-14
<i>Data Streaming Transmission Interface Gating</i>		
INITiate	Enables data streaming interface transmission.	6-16
ABORt	Disables data streaming interface transmission.	6-16
<i>Sensor Information</i>		
SYSTem:INFormation:SNUMber?	Queries the serial number	6-16
SYSTem:INFormation:PNUMber?	Queries the part number	6-16
SYSTem:INFormation:MODeL?	Queries the model name	6-16
SYSTem:INFormation:CDATe?	Queries the calibration date	6-16
SYSTem:INFormation:MDATe?	Queries the manufacturing date	6-17
SYSTem:INFormation:WAVElength?	Queries the default wavelength	6-17

## SCPI Interface Section

### Syntax and Notation Conventions

Unless otherwise specified, all SCPI commands and queries follow the syntax and notation conventions specified by the SCPI Standard. For more information, refer to the [SCPI Standard](#)—found on the IVI Foundation website.

The base-10 numeric data format specification is used heavily in this section. Unless otherwise specified, numeric data items are represented as:

- Integer values
- Non-scientific notation floating point values
- Scientific notation floating point values (upper or lower case E)

For example, the following data values are functionally equivalent:

- 31256
- 31256.0
- 3.1256E4
- 31.256E3
- +3.1256E+4.

Unless otherwise specified, non-numeric data items (typically referred to as *strings*) are not quoted.

Enumerated values must exactly match, using the long form/short form comparison rules defined under the SCPI Standard.

### Commands and Queries

#### SCPI Common Commands

The SCPI Standard specifies a standard set of common commands. All common commands and queries start with an asterisk.

#### **Reset Command - \*RST**

Resets all operational parameters to their power-on states. Reset does not affect calibration settings.

Command: \*RST

Query: none

**Identification Query - \*IDN?**

Queries the meter identification string, such as model name, firmware version, and firmware date.

Query: \*IDN?

Reply: “Coherent, Inc – EnergyMax” + <type> + “–” + <version> + “–” + <firmware date>

The dash sign separates all fields within the reply string. The first field is always "Coherent, Inc." The second field is the product name, "EnergyMax," plus the type ("USB" or "RS"). The third field is the version number, having the format "V<major>.<minor><optional qualifier characters>." The fourth field is the firmware date, having the form "<3 character month name> <day of the month> <year>." The reply string is not quoted.

Example identification string: “Coherent, Inc – EnergyMax -RS – V1.3 – Jul 10 2009” *Note: The quotes are not transmitted.*

**System Options**

The system commands and queries access functionality that is exclusive of sensor measurement functions. These commands can be sent at any time without affecting a measurement in progress.

**System Restore**

Restores all user settings to the factory state—refer to Table 6-6 (p. 6-18).

Command: SYSTem:RESTore

Query: none

**Message Handshaking**

Selects the state of SCPI message roundtrip handshaking.

Command: SYSTem:COMMunicate:HANDshaking {ON|OFF}

Reply: OK if ON is selected; otherwise, no reply is sent

Query: SYSTem:COMMunicate:HANDshaking?

Reply: ON|OFF

If handshaking is ON:

- Empty commands (commands with only whitespace characters) reply with “OK\r\n”
- Valid commands with valid data reply with “OK\r\n”
- Valid queries with valid data reply as explicitly defined elsewhere in this section, followed by “OK\r\n”

- Valid commands or queries which result in an error reply with “ERR<n>\r\n,” where <n> is the error code number—refer to “Error Record Reporting and Collection” (p. 6-6).
- Unrecognized commands or queries reply with “ERR100\r\n”
- Error queuing occurs, as explicitly defined elsewhere in this section

If handshaking is OFF:

- All command and query responses will behave as explicitly defined elsewhere in this section.

### **Baud Rate**

Selects the transmit and receive baud rates together when the device has an RS-232 serial host port. The command has no effect when the device has a USB host port. The query returns the currently selected baud rate.

Command: SYSTem:COMMunicate:SERial:BAUD  
{DEfault|9600|19200|38400|57600|115200}  
Default: 9600

Query: SYSTem:COMMunicate:SERial:BAUD?  
Reply: 9600|19200|38400|57600|115200

If SCPI message handshaking is enabled, the new baud rate takes effect after the handshake is transmitted. If SCPI message handshaking is disabled, the new baud rate takes effect immediately.

### **Error Record Reporting and Collection**

Programming and system errors occasionally occur while testing or debugging remote programs, and during measurement. Error strings follow the SCPI Standard for error record definition:

<error code>,<quoted error string>

The host queries for errors in two steps:

1. The host queries for the number of error records available (N).
2. The host queries N times for the error records.

Errors are stacked up to 20 deep. In the case of error overflow, the last error in the error list is an indication of error overflow.

Possible error strings are shown in Table 6-2, below.

**Table 6-2. Error Codes and Description Strings**

<b>Error Code Number</b>	<b>Quoted Error String</b>	<b>Error Description</b>
-350	“Queue overflow”	Error queue is full
-310	“System error”	Unexpected/unrecoverable hardware or software fault
0	“No error”	No error
100	“Unrecognized command/query”	The command or query is not recognized
101	“Invalid parameter”	The command or query parameter is invalid
102	“Data error”	A data error was encountered

*Error -350* is raised when the error queue becomes full. Non-“Queue overflow” errors are replaced by “Queue overflow” errors when there is exactly one available storage location in the error queue. No additional errors are added to the error queue if the error queue is full.

*Error -310* is raised when the firmware detects an unexpected or unrecoverable error. This error condition includes unrecoverable hardware faults.

*Error 100* is raised when the device receives an unrecognized command or query.

*Error 101* is raised when the device receives a command or query with one or more invalid data parameters.

*Error 102* is raised when the device receives a command or query for which no valid data exists.

### **Error Count Query**

Queries the number of error records in the error queue at the time of the query.

Command: none

Query: SYSTem:ERRor:COUNt?

Reply: <count of error records stored in integer format>

### **Error Query**

Queries the next error record(s) in the error queue. More than one error record may be queried using the optional <error record count> parameter, which must be an integer value. A single error record is returned if <error record count> is not specified. No reply is transmitted if no error records are available.

As the meter transmits each error record:

- The error record is permanently removed from the error queue
- The queued error record count decrements by one

Command: none

Query: SYSTem:ERRor:NEXT? [<error record count>]

Default: not applicable.

Reply: <next available error record(s)>

### **All Error Query**

Queries all error records in the error queue at the time of the query. No reply is transmitted if there are no error records available.

After completion of the reply transmission:

- The error queue is empty
- The queued error record count is zero

Command: none

Query: SYSTem:ERRor:ALL?

Reply: <all available error record(s)>

### **All Error Clear**

Clears all error records in the error queue.

Command: SYSTem:ERRor:CLEar

Query: none

## **Measurement Setup and Control**

### **Measurement Mode**

Sets the meter measurement mode to select either power (Watts) or energy (Joules) measurement mode.

Command: CONFigure:MEASure {DEFault|J|W}

Default: J (Joules) mode.

Query: CONFigure:MEASure:TYPE?

Reply: J|W

### **Statistics Mode**

This command sets the statistics processing mode to either off or on.

Command: CONFigure:MEASure:STATistics {DEFault|OFF|ON}

Default: OFF

Query: CONFigure: MEASure:STATistics?

Reply: OFF|ON



**Variable Decimation**

Sets the pulse decimation rate, which takes effect at the end of the current decimation cycle. The decimation rate units are expressed pulses rounded to the nearest integer.

Pulse measurement data is selected for processing, ranging from as frequent as 1 pulse processed per 1 measured, to as infrequently as 1 pulse processed per 99999 measured. Pulse processing includes statistics processing and transmission output.

Command: CONFigure:DECimation {DEFault|1..99999}  
Default: 1

Query: CONFigure:DECimation?  
Reply: 1..99999

**Aperture Diameter**

Sets the aperture diameter.

Command: CONFigure:DIAMeter <DEFault|aperture diameter  
in mm>  
Default: 10 mm

Query: CONFigure:DIAMeter?  
Reply: <aperture diameter in mm>

**Wavelength**

Sets the current wavelength, which is committed to persistent storage when it is changed. If the requested wavelength is *greater* than the upper wavelength limit, the current wavelength is set to the upper wavelength limit. Likewise, if the requested wavelength is *less* than the lower wavelength limit, the current wavelength is set to the lower wavelength limit. The minimum and maximum allowed wavelength may also be named as data arguments. The query gets the current maximum or minimum allowed wavelengths, depending on the optional query data argument.

Command: CONFigure:WAVElength {MINimum| MAXimum|  
<requested wavelength in nm>}

Query: CONFigure:WAVElength? [MINimum|MAXimum]  
Reply (if [MINimum/MAXimum] is not specified): <granted  
wavelength in nm>

Reply (if MAXimum is specified): <allowed maximum wavelength  
in nm>

Reply (if MINimum is specified): <allowed minimum wavelength in  
nm>

## Gain Compensation

### Enable/Disable State

Enables or disables gain compensation, which is committed to persistent storage when it is changed.

Command: CONFigure:GAIN:COMPensation {DEFault|OFF|ON}  
Default: OFF

Query: CONFigure:GAIN:COMPensation?  
Reply: OFF|ON

### Factor

Sets the gain compensation factor, which is committed to persistent storage when it is changed. The gain compensation factor has no units. Error 101 is raised if the gain compensation factor is less than 0.001 or greater than 100,000.0.

Command: CONFigure:GAIN:FACTor {DEFault|<0.001..  
100000.0>}  
Default: 1.0

Query: CONFigure:GAIN:FACTor?  
Reply: <gain compensation factor>

## Range Select

Selects the meter measurement range, expressed in Joules. EnergyMax-USB and -RS sensors have two energy ranges: *Maximum* or high range, and *Minimum* or low range.

Range selection can be accomplished in two ways:

1. Express the maximum expected energy measurement in Joules and the sensor firmware will select the best range.
2. Select either the maximum or minimum range from within the EnergyMax PC software.

The measurement range is selected by expressing the maximum expected measurement, which must be greater than 0.0. The <granted full scale range> value is the lowest available full scale range that can measure the <maximum expected measurement>. For example, if the list of available ranges is 3 mJ and 30 mJ, the maximum expected measurement is 10 mJ and the granted range is 30 mJ. The <granted full scale range> is the top range available if the <maximum expected measurement> exceeds the top range value. Using the MAX and MIN parameters on the query result in obtaining either the maximum full scale reading or the minimum range full scale reading, respectively.

Command: CONFigure:RANGe:SElect {<maximum expected measurement>|MAXimum|MINimum}

Default: not applicable.

Query: CONFigure:RANGe:SElect? [MAXimum|MINimum]

Reply: <granted full scale range>

## Statistics Mode Control

Sets statistics calculation parameters to be used in the statistics operating mode.

### Batch Size

Sets the statistics batch size, which takes effect at the end of the current statistical batch. The batch size units are pulses, rounded to the nearest integer.

Command: CONFigure:STATistics:BSIZE {DEFault|2..1000000000}

Default: 100

Query: CONFigure:STATistics:BSIZE?

Reply: 2..99999

### Restart Mode

Selects the action to be taken at the end of a statistical batch. When statistics mode is on, selecting AUTomatic will begin a new batch at the next measured pulse. Selecting MANual requires the start command to begin a new batch when statistics mode is on—refer to the CONFigure:STATistics:START command under “Batch Initiation and Termination,” below.

Command: CONFigure:STATistics:RMODE {DEFault|MANual|AUTomatic}

Default: MANual

Query: CONFigure:STATistics:RMODE?

Reply: MAN|AUT

### Batch Initiation and Termination

#### Start a New Batch

Terminates the current statistical batch and starts a new one.

Command: CONFigure:STATistics:START

Query: none

The command is ignored if statistics mode is off.

#### Stop a Batch

Terminates the current statistical batch if a batch is in progress.

Command: CONFigure:STATistics:STOP

Query: none

The command is ignored if statistics mode is off or a batch is not in progress.

## Trigger Parameters

### Trigger Source

Selects the trigger source.

Command: TRIGger:SOURce {DEFault|INTernal|EXTernal }

Default: INTernal

Query: TRIGger:SOURce?

Reply: INT|EXT

The trigger source setting has no effect on devices positioned as slaves in trigger-bussed configurations. All slaves receive their triggers from the trigger bus.

### Internal Trigger

#### Level

Sets the trigger level expressed as a percentage of full-scale capability.

Command: TRIGger:LEVel {DEFault|0.01..30.0}

Default: 5

Query: TRIGger:LEVel?

Reply: 0.01..30.0

The trigger level setting has no effect when external triggering is selected, or on devices positioned as slaves in trigger-bussed configurations. All slaves receive their triggers from the trigger bus.

### External Trigger

The external trigger settings has no effect when internal triggering is selected, or on devices that are positioned as slaves in trigger-bussed configurations.

#### Edge Select

Selects the external trigger edge. The selected trigger edge is the external trigger event.

Command: TRIGger:SLOPe {DEFault|POSitive|NEGative}

Default: POSitive

Query: TRIGger:SLOPe?

Reply: POS|NEG

### Delay

Selects the external trigger delay time. The internal trigger happens at the time marked by the external trigger delay time after the selected external trigger edge. The trigger delay time units are microseconds.

Command: TRIGger:DELAy {DEFault|0..1000}

Default: 0

Query: TRIGger:DELAy?

Reply: 0..1000

### **Set Sequence ID**

Sets the sequence ID, which must be an integer value.

The sequence ID is used for data synchronization of multiple meters sharing the same trigger signal.

Command: TRIGger:SEQuence {DEFault|0..16777215}

Default: 0

Query: none

### **Trigger Bus**

Sets the trigger bus participation mode, that is, bussed or not bussed. The query gets the trigger bus participation mode.

Command: TRIGger:BUS:PMODE {BUS|NBUS}

Query: TRIGger:BUS:PMODE?

Reply: BUS|NBUS

This command is used to designate if the device participates in the trigger bus. The designated mode must match the physical trigger bus configuration.

### Bus Control Position

Gets the trigger bus control position, that is, master or slave.

Command: None

Query: TRIGger:BUS:POSition?

Reply: MAST|SLAV

Bus position is determined by the physical position of devices stacked in a trigger bus configuration, which is one master and one or more slaves. Unbussed devices will always return MAST.

## Measurement Data Collection

Measurement data can be collected in two ways:

1. Configuring the data item select and receiving measurement data records from the Data Streaming Transmission Interface.
2. Querying the last data record generated

### Data Item Select

Data items that appear in a measurement data record are selectable. Selections differ, based on measurement and statistics modes.

#### Statistics Mode Off

Selects the statistics mode of transmit data items, which takes effect immediately if statistics mode is off. The data argument is a comma-separated list of one or more tokens shown below. At least one token must be specified. The tokens may be specified in any order.

Command: CONFigure:ITEMselect {PULS,PER,FLAG,SEQ}

Query: CONFigure:ITEMselect?

Reply: one or more of PULS|PER|FLAG|SEQ

#### Statistics Mode On

Selects the statistics mode of transmit data items, which takes effect at the end of the current statistical batch if statistics mode is on. The data argument is a comma-separated list of one or more tokens shown below. At least one token must be specified. The tokens may be specified in any order.

Command: CONFigure:STATistics:ITEMselect {MEAN,MIN,MAX,STDV,DOSE,MISS,SEQ}

Query: CONFigure:STATistics:ITEMselect?

Reply: one or more of MEAN,MIN,MAX,STDV,DOSE,MISS,SEQ

### Last Data Record Query

Gets the last recorded measurement at the time of the query. No reply is transmitted if no measurement has been recorded.

Command: none

Query: READ?

Reply: <last measurement record>

The last measurement record is composed of comma-delimited data items generated at the same instant. The data items presented—including a flags item—vary, depending on the measurement and statistics modes and the data items selected, as shown in Table 6-3 and Table 6-4, below.

**Table 6-3. Measurement Data Record Formats—Statistics Mode Off**

Measurement Mode	Measurement Record Format
Watts	<power>,<period>,<flags>,<sequence ID>
Joules	<energy>,<period>,<flags>,<sequence ID >

**Table 6-4. Measurement Data Record Formats—Statistics Mode On**

Measurement Mode	Measurement Record Format
Watts	<power>,<mean>,<min>,<max>,<stdv>,<dose>,<missed>,<flags>,<sequence ID>
Joules	<energy>,<mean>,<min>,<max>,<stdv>,<dose>,<missed>,<flags>,<sequence ID>

<power> is expressed in Watts, using the “%.3E” C formatting specification.

<energy> and <dose> are expressed in Joules, using the “%.3E” C formatting specification.

<period> is expressed in integer microseconds.

<missed> is expressed in integer units

<sequence ID> is expressed in integer dimensionless units.

Statistics data items are the same units as the power or energy measurements from which they were calculated. The <power>, <mean>, <min>, <max>, <stdv>, and <dose> data items are zero if any constituent pulse measurement in the batch is not measurable due to an error (for example, peak or baseline clipping).

The <flags> data item, which communicates qualification information, is reported with each data message. Qualification information, which includes various error conditions, is reported in a string containing one ASCII character for each qualification that is asserted. If the qualification character is present, the qualification is asserted. If the qualification condition character is absent, the qualification is not asserted. Each character present has a unique meaning, as described in the following table.

**Table 6-5. Flag Character Definitions**

Qualification Character	Qualification Meaning
P	Peak clip error (statistics mode off only)
B	Baseline clip error (statistics mode off only)
M	Missed pulse (external trigger only, statistics mode off only)
D	Dirty batch (statistics mode on only)
0 (zero)	No qualification exists

## Data Streaming Transmission Interface Gating

The host has control over when measurement data is transmitted from the data streaming transmission interface. Transmission is enabled after an INITiate command. Transmission is disabled after an ABORt command. While transmission is enabled, measurement data records are transmitted immediately as they are generated.

### Initiate Command

Enables data streaming interface transmission. This command is ignored if data streaming interface transmission is already enabled.

Command: INITiate

Query: none

### Abort Command

Disables data streaming interface transmission. This command is ignored if data streaming interface transmission is already disabled.

Command: ABORt

Query: none

## Sensor Information

The sensor can be queried for information for the purposes of unit identification and quality control.

### **Serial Number**

The query, which is always available, gets the serial number.

Query: SYSTem:INFormation:SNUMber?

Reply: <quoted serial number>

### **Part Number**

The query, which is always available, gets the serial number.

Query: SYSTem:INFormation:PNUMber?

Reply: <quoted part number>

### **Model Name**

The query, which is always available, gets the model name.

Query: SYSTem:INFormation:MODEl?

Reply: <quoted model name>

### **Calibration Date**

The query, which is always available, gets the calibration date.

Query: SYSTem:INFormation:CDATe?

Reply: <quoted calibration date>



### **Manufacturing Date**

The query, which is always available, gets the manufacturing date.

Query: SYSTem:INFormation:MDATE?

Reply: <quoted calibration date>

### **Default Wavelength**

The query, which is always available, gets the default wavelength.

Query: SYSTem:INFormation:WAVElength?

Reply: <default wavelength in nm>

## **Calibration**

All commands and queries contained in this section are used exclusively by the factory for calibration purposes. Error 100 will be raised if a valid password has not sent since the last reset cycle if any command or query contained in this section except the password command is received.

## **Data Streaming Transmission Interface Section**

The Data Streaming Transmission Interface is an out-of-band interface in which data messages are transmitted from the sensor to the host only. Gating of the data streaming transmissions is controlled by the INITiate/ABORt command, described under “Data Streaming Transmission Interface Gating” (p. 6-16).

Data streaming transmission messages are ASCII formatted, but not strictly. The high bit (mask 0x80)—which is always set for all bytes of all data streaming transmission messages, including the terminators—allows host software to easily differentiate between data streaming transmission messages and SCPI reply messages. The host may operate using the rule that if the high bit is set on any byte received from the sensor, it is part of a data streaming transmission message.

Data streaming transmission messages are immediately sent to the host in ASCII text form as pulse measurements are generated. Each message conforms to the last measurement data record format—as described under “Last Data Record Query” (p. 6-14)—but with the high bit set in all transmitted bytes.

## Operational Parameters

The following table shows all operational parameters after a reset cycle and the factory state.

**Table 6-6. Operational Parameters**

Parameter	Power-on State	Factory State
Message handshaking	Off	Off
Baud rate	9600	9600
Error count	0	0
Measure mode	Energy	Energy
Statistics mode	Off	Off
Data item select, statistics mode off	Pulse only	Pulse only
Data item select, statistics mode on	Mean only	Mean only
Variable decimation	1	1
Aperture diameter (persistent)	Last setting	1.0 cm
Current wavelength (persistent)	Last granted setting	The default wavelength
Gain compensation factor (persistent)	Last setting	1.0
Gain compensation state (persistent)	Last setting	Off
Range	Max	Max
Statistics batch size (persistent)	Last setting	100
Statistics restart mode (persistent)	Last setting	Manual
Trigger source	Internal	Internal
Trigger level	20%	20%
Trigger edge	Rising	Rising
Trigger delay	0 microseconds	0 microseconds
Trigger bus participation mode	Not bussed	Not bussed
Data streaming transmission interface state	Stopped/disabled	Stopped/disabled
Wavelength correction cursor	0/start	0/start

## Host Interface Glossary

**Message** - The transmission of a properly terminated string from host to sensor or from sensor to host.

**Reset cycle** - The reception of a reset command or the action of disconnecting power and then connecting power to the sensor. Either event sets all non-persistent operational parameters to their default settings.

**Ignored command/query** - A defined response for commands or queries in which no internal or external action is taken and the command or query is dropped. The meter responds to ignored commands/queries as if the command or query was never sent.

**Factory settings** - Persistent settings typically set by the manufacturer. They are parameters whose access is restricted by password. Factory settings do not include operational parameters.

**Missed pulse** - A measured pulse that registers with a peak value that does not exceed the baseline value. Missed pulses are detectable only under external trigger conditions.



# CALIBRATION AND WARRANTY

In this section:

- Coherent calibration facilities and capabilities (this page)
- Optical calibration method (p. 7-2)
- Limited warranty (p. 7-3)
- Extended warranty (p. 7-4)
- Warranty limitations (p. 7-4)
- Obtaining service (p. 7-5)
- Product shipping instructions (p. 7-6)

## **Coherent Calibration Facilities and Capabilities**

As the largest laser manufacturer in the world, Coherent has been able to build state-of-the-art calibration facilities containing the widest possible range of laser types and technologies. This enables us to perform instrument and sensor calibration under virtually any combination of wavelength, power, and operating characteristics. Sensors are calibrated against NIST-traceable working standard sensors which are, in turn, calibrated against NIST-calibrated golden standard sensors. These working and golden standards are maintained with the utmost care, recalibrated annually, and verified even more regularly. We maintain multiple NIST-calibrated standards at many laser wavelengths to support the growing calibration needs of our customers. Optical calibration is a core competency at Coherent and we strive to continually improve our methods, precision, and repeatability. Additionally, most of the calibrations are performed with highly automated systems, thus reducing the possibility of human error to nearly zero. Strict quality inspections during many stages of calibration and testing assure a precise and accurate instrument that is NIST traceable and CE marked. The benefit to our customers is that instruments calibrated by Coherent will consistently perform as expected under their actual use conditions. We are a registered ISO 9001:2000 company, our products are NIST traceable, and our calibration labs are fully ANSI Z540 compliant.

In addition to the technological advantage, we also strive to deliver the best service in the industry, with a knowledgeable and responsive staff, and rapid turnaround.

## **Optical Calibration Method**

### **EnergyMax NIST Traceable Optical Calibration**

Coherent provides a NIST (U.S. National Institute of Standards and Technology) traceable calibration certificate with every sensor that is shipped.

The calibration factor of an EnergyMax-USB/RS energy sensor specifies the magnitude of the pulse output for one joule optical input.

### **Re-certify Once a Year**

Coherent laser power and energy meters are precision instruments, capable of delivering very accurate measurements as well as providing many years of useful service. To maintain this high level of performance, and to ensure compliance with your quality and ISO certification, it is important to have your measurement system serviced and re-certified once per year.

Extended use of laser power and energy meters and sensors, as well as environmental factors, can have an adverse effect on accuracy and can also result in wear and/or damage to parts critical to maintaining optimum performance.

### **Calibration Fundamentals**

EnergyMax-USB/RS sensors contain the analog-to-digital conversion, peak detection, and gain stages integrated into the sensor cable. The electronics and sensor are calibrated together as a system, using the following calibration principles.

Coherent performs an optical calibration using a ratiometric substitution method to remove laser energy variation as a source of error and to eliminate dependence on the absolute value of the beam splitter ratio, as diagrammed in the figure shown below.

By introducing a beamsplitter, each laser pulse can impinge on two sensors and the ratio of two sensor outputs can be measured on each pulse. This ratio is independent of the actual pulse energy.

The actual calibration involves calculating ratios with respect to the reference sensor for the working standard and then for the Unit Under Test (UUT).

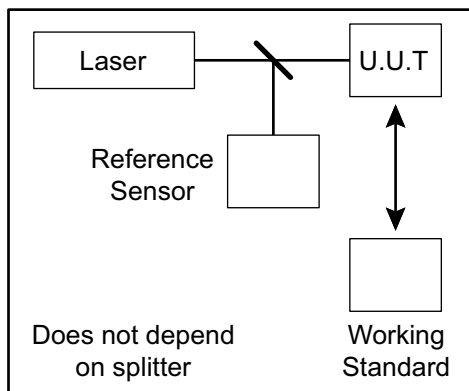

**Figure 7-1. Ratiometric Method of Optical Calibration**

To produce a ratio, a sample comprised of 15 seconds of data is taken and then averaged, and is then used to calculate the final calibration factor.

## Calibration Verification

After calibration, each sensor is tested to verify the calibration. The result of this verification is presented on the second page. Each sensor contains two gain stages. Each stage is calibrated and tested in this manner.

## Limited Warranty

Coherent, Inc. (the “Company”) warrants its laser power and energy meters and sensors products (“Products”) to the original purchaser (the “Customer”) that the product is free from defects in materials and workmanship and complies with all specifications, active at the time of purchase, for a period of twelve (12) months.

Coherent, Inc. will, at its option, repair or replace any product or component found to be defective during the warranty period. This warranty applies only to the original purchaser and is not transferable.

## **Extended Warranty**

Coherent, Inc. (the “Company”) offers original purchasers (the “Customer”) purchasing laser power and energy meters and sensors products (“Products”) an extended twelve (12) month warranty program, which includes all parts and labor. In order to qualify for this warranty, a Customer must return the Product to the Company for recalibration and recertification. The Company will re-certify the Product, provide software upgrades, and perform any needed repairs, and recalibrate the Product, for a fixed service fee (as established by the Company from time to time and in effect at the time of service). If the product cannot be re-certified due to damage beyond repair, parts obsolescence, or other reasons, the Customer may be informed that an Extended Warranty program is not available for the Product.

If the Product fails and is returned to the Company within one year following the date of recalibration and recertification service, the Company will, at its option, repair or replace the Product or any component found to be defective. If the Product must be replaced and the Product is no longer available for sale, Coherent reserves the right to replace with an equivalent or better Product. This warranty applies only to the original purchaser and is not transferable.

## **Warranty Limitations**

The foregoing warranties shall not apply, and Coherent reserves the right to refuse warranty service, should malfunction or failure result from:

- Damage caused by improper installation, handling or use.
- Laser damage (including sensor elements damaged beyond repair).
- Failure to follow recommended maintenance procedures.
- Unauthorized product modification or repair.
- Operation outside the environmental specifications of the product.

Coherent assumes no liability for Customer-supplied material returned with Products for warranty service or recalibration.

THIS WARRANTY IS EXCLUSIVE IN LIEU OF ALL OTHER WARRANTIES WHETHER WRITTEN, ORAL, OR IMPLIED. COHERENT SPECIFICALLY DISCLAIMS THE IMPLIED WARRANTIES OF MERCHANTABILITY AND FITNESS FOR A PARTICULAR PURPOSE. IN NO EVENT SHALL THE COMPANY BE LIABLE FOR ANY INDIRECT, INCIDENTAL OR CONSEQUENTIAL DAMAGES IN CONNECTION WITH ITS PRODUCTS.



## Obtaining Service

In order to obtain service under this warranty, Customer must notify the Company of the defect before the expiration of the warranty period and make suitable arrangements for the performance of service. The Company shall, in its sole discretion, determine whether to perform warranty service at the Customer's facility, at the Company's facility or at an authorized repair station.

If Customer is directed by the Company to ship the product to the Company or a repair station, Customer shall package the product (to protect from damage during shipping) and ship it to the address specified by the Company, shipping prepaid. The customer shall pay the cost of shipping the Product back to the Customer in conjunction with recalibration and recertification; the Company shall pay the cost of shipping the Product back to the Customer in conjunction with product failures within the first twelve months of time of sale or during an extended twelve month warranty period.

A Returned Material Authorization number (RMA) assigned by the Company must be included on the outside of all shipping packages and containers. Items returned without an RMA number are subject to return to the sender.

For the latest Customer Service information, refer to our website: [www.Coherent.com](http://www.Coherent.com).

Detailed instructions on how to prepare a product for shipping are described under "Product Shipping Instructions" (p. 7-6)

**Table 7-1. Coherent Service Centers**

Location	Phone	Fax	E-mail
USA	1.800.343.4912	503.454.5777	info_service@Coherent.com
Europe	+49-6071-968-0	+49-6071-968-499	info_service@Coherent.com
International	503.454.5700	503.454.5777	info_service@Coherent.com

## **Product Shipping Instructions**

To prepare the product for shipping to Coherent:

1. Contact Coherent Customer Service—refer to Table 7-1 (p. 7-5)—for a Return Material Authorization number.
2. Attach a tag to the product that includes the name and address of the owner, the person to contact, the serial number, and the RMA number you received from Coherent Customer Service.
3. Position the protective cap over the sensor.
4. Place the sensor in the original shipping carton and then situate the foam cutout over the sensor to hold it in place during shipment.

If the original packing material and shipping carton are not available, obtain a corrugated cardboard shipping carton with inside dimensions that are at least 6 in. (15 cm) taller, wider, and deeper than the sensor. The shipping carton must be constructed of cardboard with a minimum of 375 lb. (170 kg) test strength. Wrap the sensor with polyethylene sheeting or equivalent material and then cushion the sensor in the shipping carton with packing material or urethane foam on all sides between the carton and the sensor. Allow 3 in. (7.5 cm) on all sides, the top, and the bottom.

5. Seal the shipping carton with shipping tape or an industrial stapler.
6. Ship the product to:

Coherent, Inc.  
27650 SW 95th Ave.  
Wilsonville, OR 97070  
Attn: RMA # (add the RMA number you received from  
Coherent Customer Service)

## APPENDIX A: FREQUENTLY ASKED QUESTIONS

This appendix gives answers to common questions about Coherent EnergyMax sensors.

*Q: What if I exceed the average power specification?*

A: Use of a sensor beyond its average power specification will result in increased error, and can result in damage to the sensor if the temperature gets too hot. Optional EnergyMax heatsinks are available to increase the average power specification of certain sensors (for more information about heatsinks—refer to “Increasing Average Power With Heatsinks” (p. 3-1)).



---

### **NOTICE!**

**Use of EnergyMax sensors at average power levels beyond the base model average power specification—without the optional heatsink—can cause permanent damage to the sensor.**

---

*Q: What if I exceed the repetition rate specification?*

A: Use of EnergyMax sensors beyond the repetition rate specification will result in additional measurement error. Increased repetition rate also increases the average power, so do not apply more average power than can be handled by the sensor.

*Q: What if I exceed the maximum energy specification?*

A: EnergyMax sensors have an active circuit that will saturate if the applied energy is too high. There is some headroom above the maximum specification (the amount of headroom is dependent on sensor responsivity and varies from 5 to 25%, depending on the individual sensor), but the maximum level should not be exceeded. Another implication of using a sensor above its rated energy is the potential of high energy density damaging the coating.

*Q: What if I exceed the pulse width specification?*

A: Although there is some headroom built into the specification, using an EnergyMax sensor with a laser that has a pulse width longer than the specified maximum pulse width will result in increased measurement error. For example, if you use the sensor with double the maximum pulse width, the result will be an additional 2 to 3% error.

*Q: Why isn't there a minimum pulse width specification?*

A: These pyroelectric energy sensors can function with pulse widths as short as nanoseconds, picoseconds, or even femtoseconds, and still measure correctly. As described in the previous answer, the maximum pulse width specification is important and is limited by the fall time of the sensor, so Coherent only specs the maximum—not the minimum—pulse width. As the pulse width gets shorter, the only change that occurs is that the damage threshold on the energy sensors decreases. When using really short pulses, pay close attention to the damage threshold specifications and make use of the damage test slide.

*Q: Can I use the sensor at a wavelength different from the one it was calibrated at?*

A: Yes. EnergyMax sensors have a wavelength compensation table in the circuitry inside the sensor. Plug the sensor into your meter and go to the wavelength setup. Enter the wavelength of your laser and the sensor will correct for any spectral and/or transmission changes due to wavelength—refer to Figure 3-3 (p. 3-7) for more information.

# INDEX

## A

- Active area diameter 2-4
- ANSI Z540 7-1
- Average power
  - Increasing with heatsinks 3-1
  - Linearity 3-4
  - Ratings 3-2
  - Specification 8-1

## C

- Cable length 2-4
- Cable length, extending 5-2
- Calibration
  - Facilities and capabilities 7-1
  - Fundamentals 7-2
  - Uncertainty 2-4
  - Verification 7-3
  - Wavelength 2-4
- Calibration and warranty 7-1
  - Coherent calibration facilities and capabilities 7-1
  - Extended warranty 7-4
  - Limited warranty 7-3
  - Obtaining service 7-5
  - Optical calibration method 7-2
  - Product shipping instructions 7-6
  - Warranty limitations 7-4
- Coherent
  - Calibration facilities and capabilities 7-1
  - Service centers 7-5

## Compliance

- RoHS 1-1

## D

- Damage
  - Test slide x
  - Thresholds 3-3
- Declaration of Conformity 1-2
- Description 2-1
  - Post and stand assembly x
  - Unpacking and inspection ix
- Diffuse metallic EnergyMax sensors 2-5

## E

- Energy
  - Linearity 3-4
  - Range 2-4
- EnergyMax NIST traceable optical calibration 7-2
- EnergyMax sensors
  - Diffuse metallic 2-5

- MaxBlack 2-4
- MaxBlack with diffusers 2-6
- MaxUV 2-7
- Quantum 2-8

- Environmental regulations 1-1
  - RoHS compliance 1-1
  - Waste Electrical and Electronic Equipment (WEEE, 2002) 1-1
- Extended warranty 7-4

## F

- Frequently asked questions 8-1

## H

- Heat sinks 3-1
- Host interface 6-1

## I

- Increasing average power with heatsinks 3-1
- Interface
  - Host 6-1
- ISO 9001:2000 7-1
- Item/part numbers 2-4

## L

- Label, Waste Electrical and Electronic Equipment (WEEE, 2002) 1-1
- LED status indicators 4-1, 5-1
- Limited warranty 7-3
- Linearity 3-4

## M

- MaxBlack coating 2-4
- MaxBlack EnergyMax sensors 2-4
- MaxBlack EnergyMax sensors with diffusers 2-6
- Maximum
  - Average power 2-4
  - Energy 8-1
  - Energy density 2-4
  - Pulse width 2-4
  - Repetition rate 2-4
- MaxUV EnergyMax sensors 2-7
- Measurement linearity 3-4
  - Average power 3-4
  - Energy 3-4
  - Pulse width 3-5
  - Repetition rate 3-4
- Messages
  - Received by the sensor 6-1
  - Sent by the sensor 6-1

**N**

NIST traceability 7-1  
Noise equivalent energy 2-4

**O**

Obtaining service 7-5  
Operating the software 4-1  
Optical calibration  
    Method 7-2  
    Ratiometric method 7-3  
Optical calibration method  
    Calibration fundamentals 7-2  
    Calibration verification 7-3  
    EnergyMax NIST traceable optical calibration 7-2  
    Re-certify once a year 7-2

**P**

Post and stand assembly x  
Power measurements, taking 4-5  
Preface vii  
Product overview  
    Diffuse metallic EnergyMax sensors 2-5  
    MaxBlack EnergyMax sensors 2-4  
    MaxBlack EnergyMax sensors with diffusers 2-6  
    MaxUV EnergyMax sensors 2-7  
    Quantum EnergyMax Sensors 2-8  
Product shipping instructions 7-6  
Publication updates ix  
Pulse width  
    Linearity 3-5  
    Specification 8-1  
Pyroelectric  
    Current and voltage response 3-3  
    Technology 3-2

**Q**

Quantum EnergyMax sensors 2-8

**R**

Ratiometric method of optical calibration 7-3  
Re-certify once a year 7-2  
Repetition rate  
    Linearity 3-4  
    Specification 8-1  
Response, spectral 3-5  
Return material authorization number (RMA) 7-6  
RoHS compliance 1-1

RS sensors, powering 4-2

**S**

Safety 1-1  
    Declaration of Conformity 1-2  
    Environmental regulations 1-1  
Service, obtaining 7-5  
Shipping instructions, product 7-6  
Specifications  
    Diffuse metallic EnergyMax sensor 2-5  
    MaxBlack EnergyMax sensor 2-4  
    MaxBlack EnergyMax sensor with diffuser 2-6  
    MaxUV EnergyMax sensor 2-7  
Spectral  
    Absorption of EnergyMax sensor coatings 3-7  
    Response 3-5  
    Sensitivity of EnergyMax sensors with  
        diffusers 3-8  
Status indicators, LED 4-1, 5-1  
Symbols used in this document vii

**T**

Technical description 3-1  
    Damage thresholds 3-3  
    Increasing average power with heat sinks 3-1  
    Measurement linearity 3-4  
    Pyroelectric technology 3-2  
    Spectral response 3-5  
Technology, pyroelectric 3-2

**U**

Unpacking and inspection ix

**W**

Warranty  
    Extended 7-4  
    Limitations 7-4  
    Limited 7-3  
Waste Electrical and Electronic Equipment (WEEE,  
2002) 1-1  
Wavelength  
    Compensation 3-6, 8-2  
    Compensation accuracy 3-6  
    Range 2-4  
Wavelength, setting 4-14



