



USER MANUAL

ELECTROSTATIC FIELD METER

PFM-711B CPM-720B PCS-730B PFK-100B

Table of Contents

Important Safety Information	2
INTRODUCTION	4
GETTING STARTED	5
PFM-711B Pushbuttons	5
Display Features	6
INSTALLATION	7
Battery Installation	7
Low Battery Indicator	7
FUNCTION	8
Zero Adjustment	8
Range Selection	8
Hold Function	8
LED Ranging Lights	9
Analog Output Mode	9
OPERATION	10
Grounding Connection	10
Static Charge Measurement	10
CPM-720B CHARGE PLATE ASSEMBLY	11
Mounting the Charge Plate Monitor Assembly	12
PCS-730B ELECTROSTATIC CHARGER	14
PCS-730B Pushbuttons	15
Battery Installation	15
Low Battery Indicator	16
Operation	16
Ion Balance Measurement	17
Ion Blower Decay Performance Check	19
Body Voltage Generation	21
MAINTENANCE AND USER ADJUSTMENT	23
PFM-71B Field Meter	23
CPM-720B Charge Plate Assembly	23
PCS-730B Electrostatic Charger	24
TROUBLESHOOTING	24

Warning! Important Safety Information







Please read the Safety Instructions before using your Meter.

Refer to the table below for an explanation of symbols which may be on your Prostat product.

In this manual, a Warning identifies conditions and actions that pose hazards to the user. A Caution identifies conditions and actions that may damage the Meter or the equipment under test.

The Meter complies with:

- ANSI/ESD S3.1
- ANSI/ESD SP3.3
- ESD TR53
- ANSI/ESD S20.20

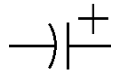
<p>CAUTION: TO REDUCE THE RISK OF ELECTRIC SHOCK, DO NOT REMOVE COVER (OR BACK). THERE ARE NO USER SERVICEABLE PARTS INSIDE. REFER ALL SERVICING TO QUALIFIED PERSONNEL.</p>		<p>AC voltage: Rated voltage marked with this symbol is AC voltage.</p>	
	<p>This symbol indicates that high voltage is present inside. It is dangerous to make any kind of contact with any internal part of this product.</p>		<p>DC voltage: Rated voltage marked with this symbol is DC voltage.</p>
	<p>This symbol indicates that this product has included important literature concerning operation and maintenance.</p>		<p>Caution. Consult instructions for use: This symbol instructs the user to consult the user manual for further safety related information.</p>
	<p>This symbol indicates earth ground.</p>		<p>This symbol represents capacitance.</p>

- This apparatus uses batteries. In your community, there might be environmental regulations that require you to dispose of these batteries properly. Please contact your local authorities for disposal or recycling information.
- Never insert anything metallic into the open parts of this apparatus. This may cause a danger of electric shock.
- To avoid electric shock, never touch the inside of this apparatus. Only a qualified technician should open this apparatus.
- Do not drop or strike the product. If the product is damaged, contact a Prostat Authorized Service Center.
- This apparatus may produce voltages which may damage some electronic components. Remove any such components from vicinity before operating this apparatus.
- This apparatus uses LED's to indicate proper distance of measurement. Do not point ranging lights into anyone's eyes.

- This equipment is intended for use in electrostatic processes that are free from water, oil, solvent and other conductive contaminants. Exposure to such contaminants will cause failure of the electrical insulation system in the product
- This equipment must have proper grounding for accurate measurement.
- This equipment is likely to be damaged if dropped. In such an event, it should be carefully examined and any necessary repairs be made by an authorized technician.
- This is an electronic instrument and contains a sensor that is sensitive to mechanical vibrations and shock. As it also contains a microcomputer chip and electronic circuitry, it should not be used in an environment where there is a lot of electromagnetic noise.
- Suspend measurement when the voltage reading is outside the measuring range. If the range is exceeded, there is a possibility of damaging the sensor.
- It is possible to use this product in ionized air. However, normally specified accuracy of 5% cannot be guaranteed in this case
- Do not exert any pressure on the LCD display from the top.
- In rare cases cleaning the PFM-711B, case and display with a slightly dampened cloth may be required. Should this be required, use a very weak solution on of liquid soap and water. The cloth should be barely damp. DO NOT allow the instrument to become wet with the cleaning solution.
- The instrument has been calibrated for a measuring distance of 1" (25 ±0.5 mm). This calibration is not valid outside this distance. Do not tamper with the sensor location and the guiding LEDs for that could alter the measuring distance
- DO NOT allow cleaning solution to enter the unit through apparatus openings. Should the unit become damaged with cleaning solutions, the warranty is voided.
- Do not expose this apparatus to dripping or splashing.
- Do not dispose of batteries in a fire.
- Do not short-circuit, disassemble, or overheat the batteries.

01 INTRODUCTION

The PFM-711B is an accurate, portable electrostatic field measuring device that is easy to use and designed for one hand operation. The PFM-711B is a digital, electronic chopper design, which allows the instrument to make electrostatic field measurements in areas where ionized air is present.

For accurate, repeatable performance, the PFM-711B must be grounded during normal operations. Used by itself, the PFM-711B will measure electrostatic fields emanating from virtually any flat surface or object.

The PFM-711B uses a dual range for measuring surface voltage and electrostatic potentials. In the kV/inch range, the PFM-711B will indicate electrostatic field voltage from 0 to $\pm 20,000$ volts in 10 volt increments at a distance of 1" (25 mm) from the charged surface with an accuracy of $\pm 5\%$ of the displayed value.

In the V/inch range, the instrument measures field density from 0 to $\pm 1,999$ volts in 1 volt increments at a distance of 1" (25 mm) from the charged surface with an accuracy of $\pm 5\%$ of the displayed value.

The two LED ranging lights help position the meter at the right distance from a charged object for accurate measurements.

The conductive case and ground snap provides the ground reference for its measuring circuit. For accurate measurements, it is necessary that the person holding the meter be properly grounded, or the meter has a ground connection made to the metal snap on the case.

By attaching a CPM-720B Charge Plate to the PFM-711B, the meter can also be used for Ion Balance voltage measurements.

The PCS-730B can be used to place a $\pm 1000V$ charge on the CPM-720B Charge Plate making it possible to also measure the discharge times of air ionization equipment per ANSI/ESD SP3.3 Periodic Verification of Air Ionizers.

02 GETTING STARTED

PFM-711B Pushbuttons

The PFM-711B has four (4) button switches to perform many functions:





Button	Color	Name	Function
	White	POWER	Press once (short press to turn the meter ON. Press and hold for 2 seconds (long press) to turn the meter OFF.
	Green	MEASUREMENT RANGE	Selects the measuring range between Low Range (V/inch) and High Range (kV/Inch).
	Blue	MEASUREMENT HOLD	Holds the measured value. Press again to return to normal measurement operation.
	Yellow	DIGITAL ZERO	Adjusts the displayed value to zero (0).

Table 1. PFM-711B Pushbuttons

Display Features

The LCD is a large 3.5 digit reflective display:

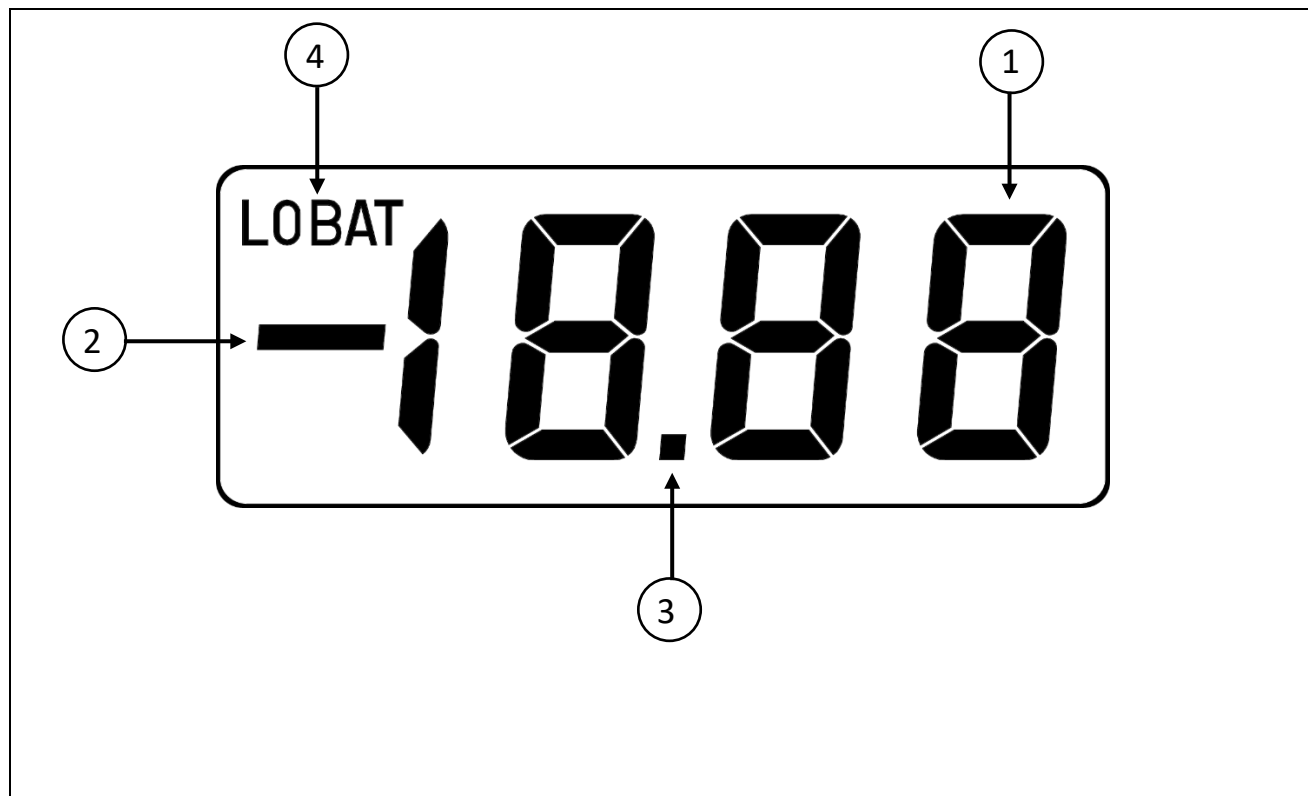

Figure 1. Display Features (PFM-711B)

Number	Feature	Indication
①		Digital numerical value.
②		Negative polarity.
③		Decimal point. Visible in high range (kV/Inch) range only.
④	LOBAT	Indicates low battery.

Table 2. Display Features (PFM-711B)

03 INSTALLATION

This equipment is battery operated, do not connect with any other utility line. Install the battery provided according to the procedure described below.

Battery Installation

The PFM-711B uses one (1) 9 VDC alkaline battery (included), which provides an approximate life of 30 hours. To install or replace the battery, follow this procedure:

1. On the back of the meter, there's a battery compartment. Carefully press down the cover using its grooves.
2. Lift the battery from the case bottom, and carefully disconnect the battery connector leads.
3. Firmly snap the battery connector leads to the terminals of a new battery and reinsert the battery into the case bottom. Dress the battery leads so that they will not be pinched between the case bottom and case top.
4. Make certain of the polarity (+ and -) as this could damage the meter.
5. Carefully reclose the battery compartment cover.

Low Battery Indicator

The LCD is designed to indicate when the battery is low. When the battery reaches approximately 7.2 DC volts, **LOBAT** will be displayed. For reliable and accurate measurements, it is recommended that you replace the battery when this indicator appears (Figure 2).

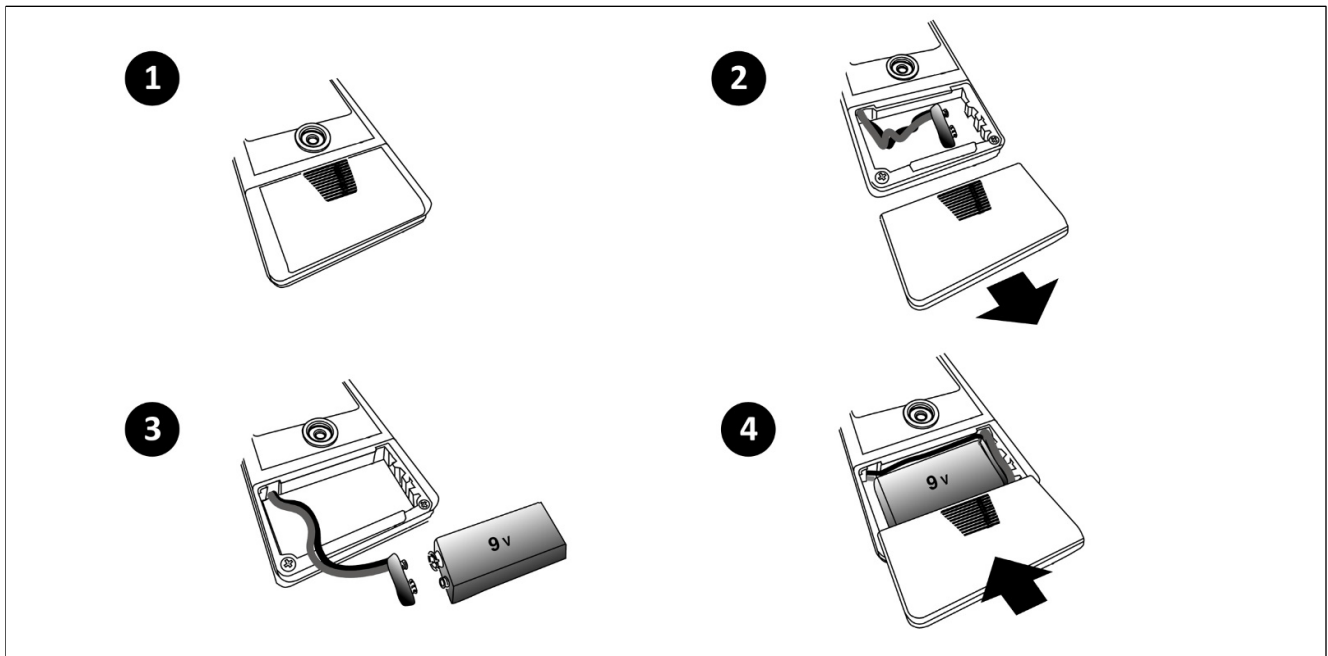

Figure 2. Battery Replacement (PFM-711B)



CAUTION!

- Do not exert excessive pressure; it might damage the battery compartment cover.
- Be careful while connecting or disconnecting a battery. Do not pull the plug by the connecting leads.
- The plug will be damaged when it is connected forcibly in the wrong polarity terminals.
- Before closing the cover, make sure that no part of the leads are outside the battery compartment.

04 FUNCTION

Zero Adjustment

A blue **ZERO** button switch on the front panel can be used to adjust the reading to zero (0.00) if the field meter reading is not zero. To make PFM-711B read zero in this condition, press and hold the **ZERO** button pointing the unit away from charged surfaces and objects. You may need to press and hold the zero button more than once to obtain zero (0.00). The zero adjustment procedure works in either **kV/inch** or **V/inch** mode.

Note: When the PFM-711B is in HOLD mode, the Zero Adjustment function is inoperative.

Range Selection

The green **RANGE** button switch allows the user to select the proper range of measurement. When turning the meter on, the default range selected is **kV/inch**. By pressing the **RANGE** button, the range is switched to **V/inch**.

Note: If turning the meter off while in the V/inch range, the meter will default back to kV/inch when turning the meter back on.

Hold Function

With the meter in the measurement position, press the **HOLD**. This will freeze the digital measurement on the display, allowing the meter to be moved to a position where it may be more easily read and documented.

When the meter is in the **HOLD** function, the LED of the selected range will be blinking. The two LED ranging lights are turned off. We recommend putting the meter in the HOLD function between measurements to preserve battery life.

Pressing the **HOLD** button again will cancel the HOLD function and return the meter in its measuring position.

Note: The display of measured voltage is not saved in PFM-711B, even if it is turned off in HOLD mode. Data and mode information will be lost by turning the meter off.

LED Ranging Lights

The PFM-711B has two red LEDs on the front end of the meter to position the unit at the right distance from a charged object.

Hold the front of the meter approximately 1" inch (25mm) from the surface to be measured. Adjust the distance from the test surface until the ranging lights form a Bull's Eye (Table 1). Allow the instrument to stabilize.







Target	Measuring Distance	Acceptable
	Distance from measuring surface it less than 1" (25mm)	
	Distance from the measuring surface is at 1" (25mm)	
	Distance from surface is greater than 1" (25mm)	

Table 3. LED Ranging Lights

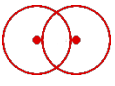

WARNING!

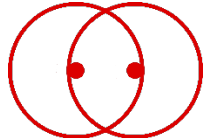
Do not shine the RED Bull's Eye Ranging lights into yours or anyone else's eyes.

Analog Output Mode

With the optional analog output cable, you can use an analog out. The analog output cable is used to connect the PFM-711B Field Meter to an X-Y Plotter or analog data recorder or timing device.

The analog output is a 2.5 mm jack (3/32") monophone jack may be connected to an oscilloscope, strip chart recorder, external meter or other device. 1 volt at this output corresponds to 10 kV \pm 20 kV.

05 OPERATION

Grounding Connection

For proper measurement, the operator should select and wear a wrist strap that is confirmed functional and properly grounded. Without properly grounded, the accuracy might be affected by the static charge on the operation making the measurement.

Press the  button once to turn the meter ON. The default measuring range is **kV/Inch**. It is recommended to let the meter warm up for 10 minutes before making a measurement.

Confirm that the instrument's display is activated and that the battery low indication (**LOBAT**) is not displayed. If low battery is displayed, replace the battery.

The two LED ranging lights beside the sensor, also, turn on and the PFM-711B is ready for static charge measurement.



CAUTION!

The plastic case of the PFM-711B is made of conductive resin. The grounding terminal provides the reference potential for the electrical circuit. This terminal should be grounded properly for proper measurement. If it is not properly grounded, the accuracy is not guaranteed.

Static Charge Measurement

1. With the operator's fingers contacting the grounding snap on the back of the meter (Figure 3), press the green **RANGE** button switch to select the kV/inch range. The LED for **kV/inch** will be illuminated.
2. Hold a flat sheet of material in front of the meter's sensing plate to confirm operation of the ranging light system. A circle with a spot in the middle should appear clearly on the material surface when held 1" (25mm) from the meter's sensing plate (Table 3).
3. Point the unit away from surfaces and objects. Press and hold the yellow **ZERO** button until the display indicates 0.00.
4. The PFM-711B Field Meter is now ready for static charge measurements.
5. To turn off the meter, press and hold the  button for 2 seconds.

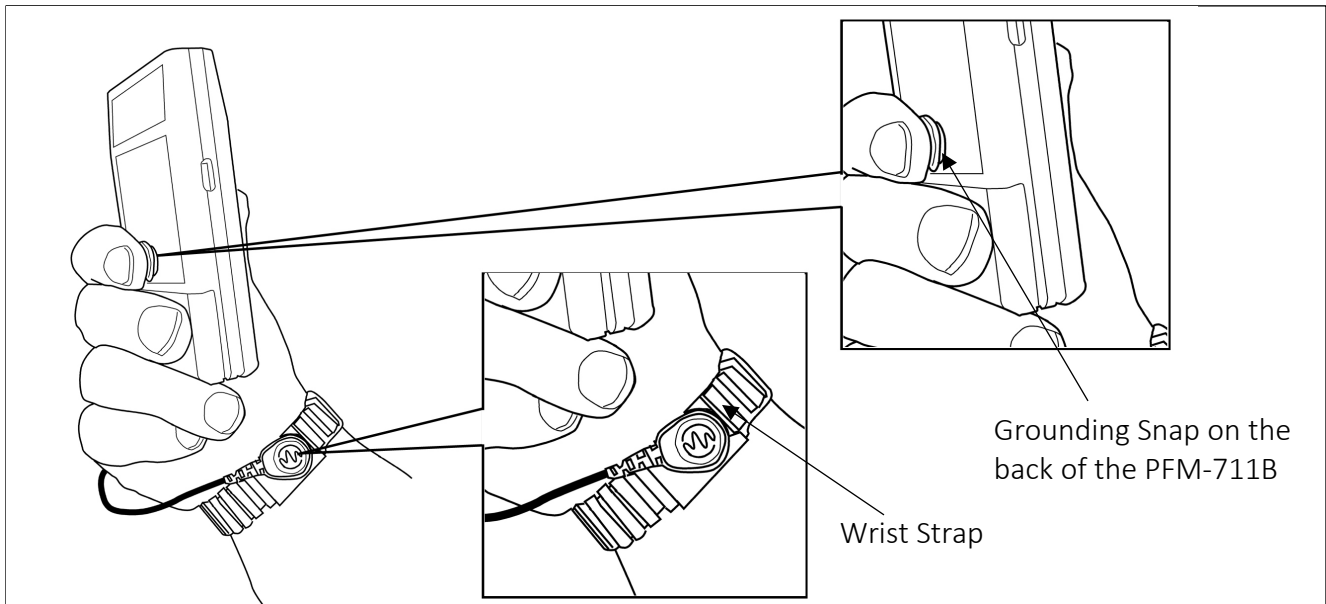

Figure 3. Operator properly grounded to use the PFM-711B



OPERATIONAL NOTE

The case of PFM-711B Field Meter is conductive and part of the instrument's grounding circuit. If one holds the meter in one hand, and attempts to measure voltage on the other hand, no reading can be obtained regardless of body voltage.

05 CPM-720B CHARGE PLATE ASSEMBLY

The CPM-720B Charge Plate Assembly is a miniature isolated plate attachment for the PFM-711B Field Meter. It converts the PFM-711B into a portable, battery operated charged plate monitor (CPM). This unique design allows precision balancing of ionizing blowers and other devices to less than ± 5 volts accuracy.

When used with auxiliary leads or wrist strap, the CPM-720B measures body voltage and equipment charge generation.

1. One parallel plate assembly equipped with Teflon insulators between parallel plates:
 - a. Upper plate is a square sensing plate equipped with a banana receptacle.

- b. Bottom plate is a ground reference plate, notched and sized for attachment to the PFM-711B.
2. A Teflon wedge is installed beneath the square upper plate for separation between the CPM-720B sensing plate and the PFM-711B Field Meter case.
3. One female metal banana plug receptacle is installed on the sensing (upper) plate.
4. A calibration adjustment screw and nut assembly is installed beneath the upper plate, between the sensing and notched ground plates.



NOTE

Each CPM-720B is calibrated at the factory to match its respective PFM-711B Field Meter. Do not modify the CPM-720B calibration adjustment without following factory Calibration procedure. Matched PFM-711B and CPM-720B units have the same serial numbers. Do not interchange.

Mounting the Charge Plate Monitor Assembly

5. With the PFM-711B Field Meter controls and the CPM-720B sensing plate facing up (the lower plate has a cutout for the meter), carefully slide the CPM-720B's lower ground plate into the lower mounting grooves molded into the sides of the PFM-711B's case (Figure 4).

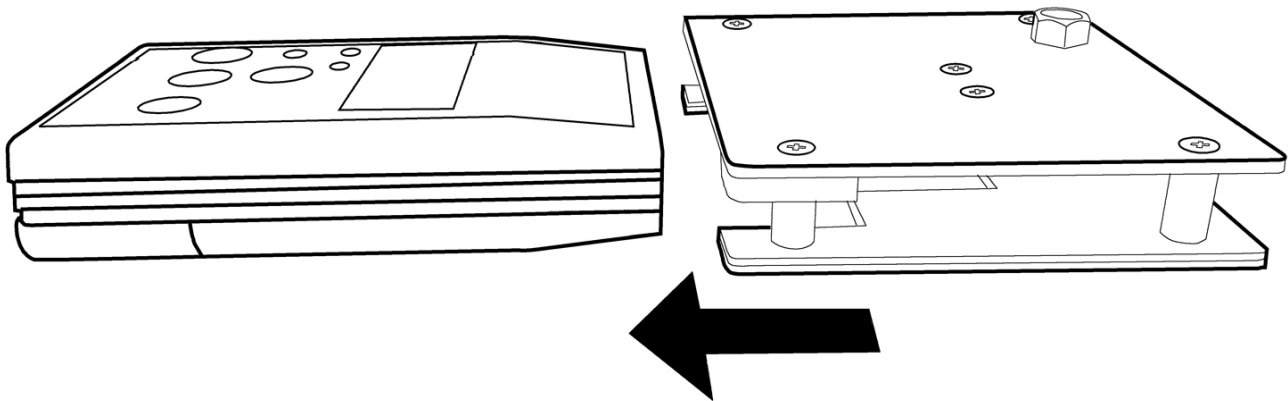

Figure 4. Sliding the CPM-720B onto the PFM-711B



NOTE

Initial mounting of the CPM-720B Charge Plate Assembly to the PFM-711B Field Meter case may be extremely snug. Be sure that the plate and meter case grooves are perfectly matched before mating the two instruments together. Subsequent uses will cause sufficient wear for easy mounting.

6. Carefully slide the plate towards the meter's sensor until the plate assembly is fully mounted to the PFM-711B (Figure 5).
 - a. The PFM-711B meter case should be mounted snugly into the lower grounding plate notch.
 - b. The Teflon wedge located beneath the upper plate isolates the upper plate from the PFM-711B meter case
3. Before operating the PFM-711B and CPM-720B, the operator should select and wear a wrist strap that is fully functional and properly grounded.

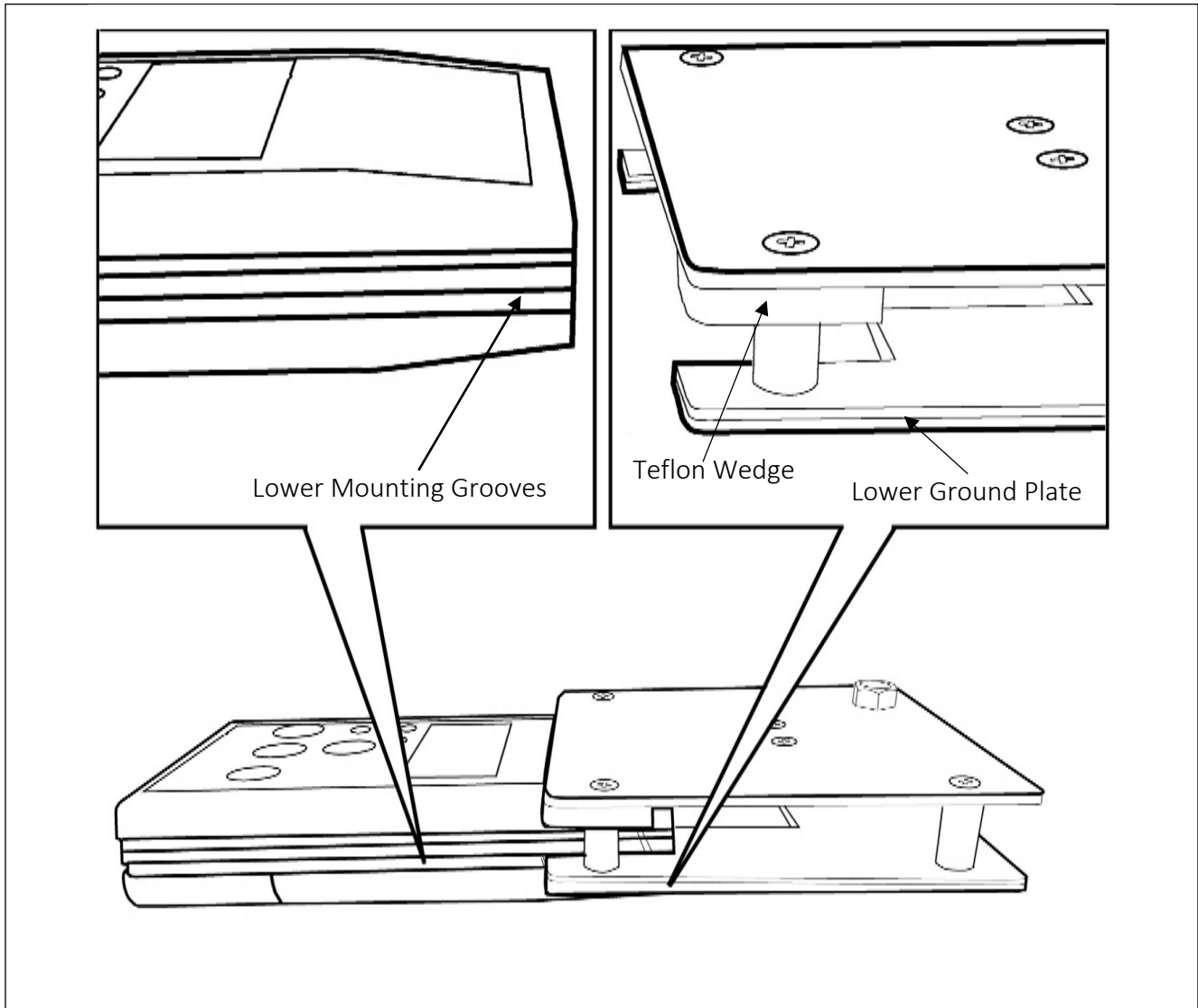

Figure 5. The CPM-720B's mounted onto the PFM-711B

06 PCS-730B ELECTROSTATIC CHARGER

Combining this unique assembly with the PCS-730B Electrostatic Charger, you can easily confirm ionizer performance, plot decay times, measure suppression, and perform a variety of other electrostatic evaluations and demonstrations.

The PCS-730B charger is a battery operated hand held device used to charge an object to approximately $\pm 1,250$ Volts $\pm 5\%$ when grounded and used with its charging wand.

Once the PFM-711B Field Meter and CPM-720B Charge Plate are assembled, the PCS-730B Electrostatic Charger will apply a defined electrostatic voltage to the CPM-720B plate.

PCS-730B Pushbuttons

The PCS-730B has two (2) button switches to charge the plate assembly:

Button	Name	Function
	+ 1kV	Applies a positive charge to the CPM-720B charge plate assembly to approximately + 1.25kV \pm 5%.
	- 1kV	Applies a negative charge to the CPM-720B charge plate assembly to approximately - 1.25kV \pm 5%.

Table 4. PCS-730B Pushbuttons

Battery Installation

The PCS-730B uses one (1) 9 VDC alkaline battery (included), which provides an approximate life of a minimum of 28 hours of continuous use (approximately 20,000 charges of either polarity). To install or replace the battery, follow this procedure (Figure 6):

1. On the back of the meter, there's a battery compartment. Carefully press down the cover using its grooves.
2. Remove the old battery carefully (if present).
3. Firmly nap the battery terminals to the appropriate connectors. Make certain of the polarity.
4. Carefully reclose the battery compartment cover.

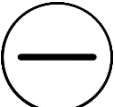
When removing the battery from the PCS-730B, do not pull on the wires. To avoid damaging the battery strap, place a small flat head screwdriver between the battery terminals and gently lift the battery.

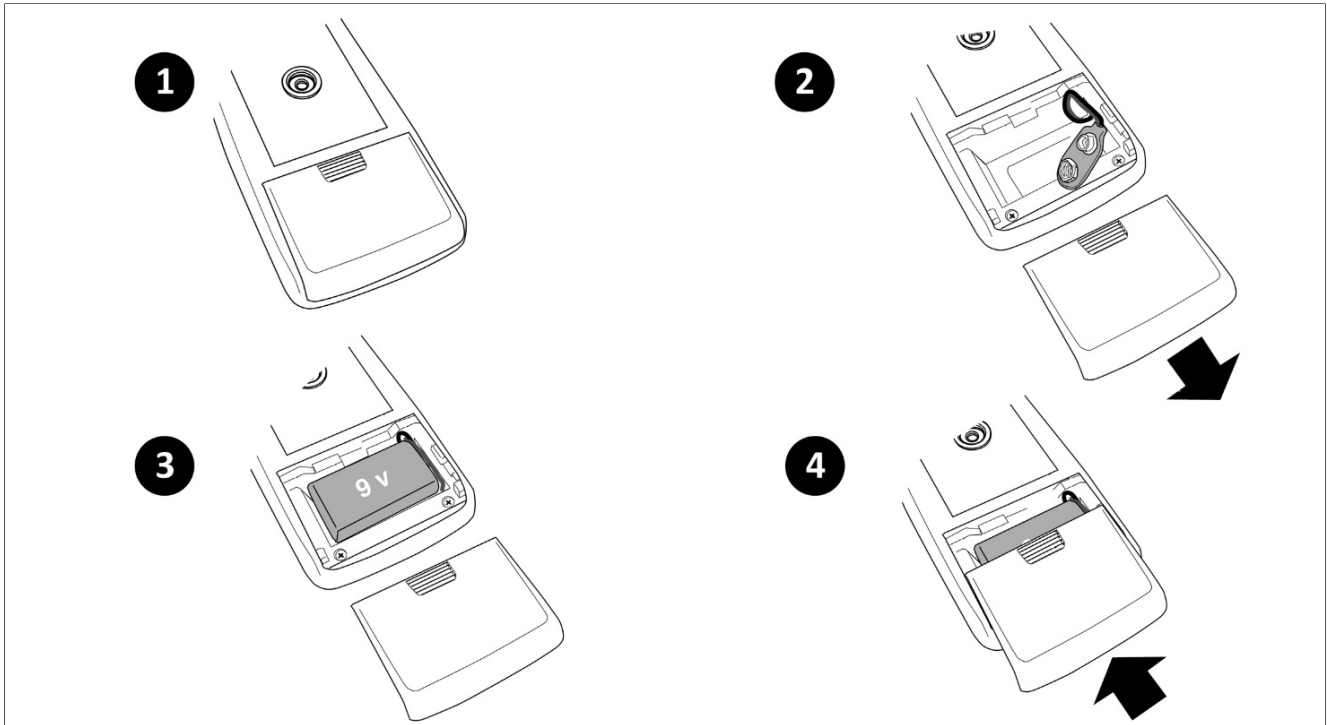

Figure 6. Battery Replacement (PCS-730B)

Low Battery Indicator

The front of the PCS-730B includes a red LED that will illuminate when the battery reaches approximately 7.7 DC volts. It is important that you replace the battery when the LED is illuminated, so that the meter is able to charge the plate assembly to at least 1000 volts.

Operation

The PCS-730B is personnel safe and easy to use. It should not be used in contact with electrostatic discharge sensitive (ESDS) devices or assemblies.

1. Install the charging rod (included) male banana snugly into the female receptacle located at the front of the PCS-730B's case. **NOTE: DO NOT ROTATE THE ROD INSIDE THE RED RECEPTACLE AS THIS MAY BREAK THE WIRE INTERNALLY.**
2. With the operator's fingers contacting the grounding snap on the back of the meter, press the green **RANGE** button switch to select the kV/inch range. The LED for **kV/inch** will be illuminated.
3. Hold a flat sheet of material in front of the meter's sensing plate to confirm operation of the ranging light system. A circle with a spot in the middle should appear clearly on the material

surface when held 1" (25mm) from the meter's sensing plate.

4. Point the unit away from surfaces and objects. Press and hold the yellow **ZERO** button until the display indicates 0.00.
5. With the operator's fingers contacting the metal grounding snap on the back of the PCS-730B Charging Source, press the + button switch (+1kV). Touch the tip of the charging wand directly to the upper sensing plate of the CPM-720B Charge Plate Assembly and charge the CPM-720B to approximately + 1.25kV \pm 5%.
6. Discharge the upper plate to ground, or short the upper and lower plates, until the PFM-711B meter reads zero (0.00).
7. With the operator's fingers contacting the metal grounding snap on the back of the PCS-730B Charging Source (Figure 7), press the - button switch (-1kV). Touch the tip of the charging wand directly to the upper sensing plate of the CPM-720B Charge Plate Assembly and charge the CPM-720B to approximately - 1.25kV \pm 5%.
8. Discharge the upper plate to ground, or short the upper and lower plates, until the PFM-711B meter reads zero (0.00).

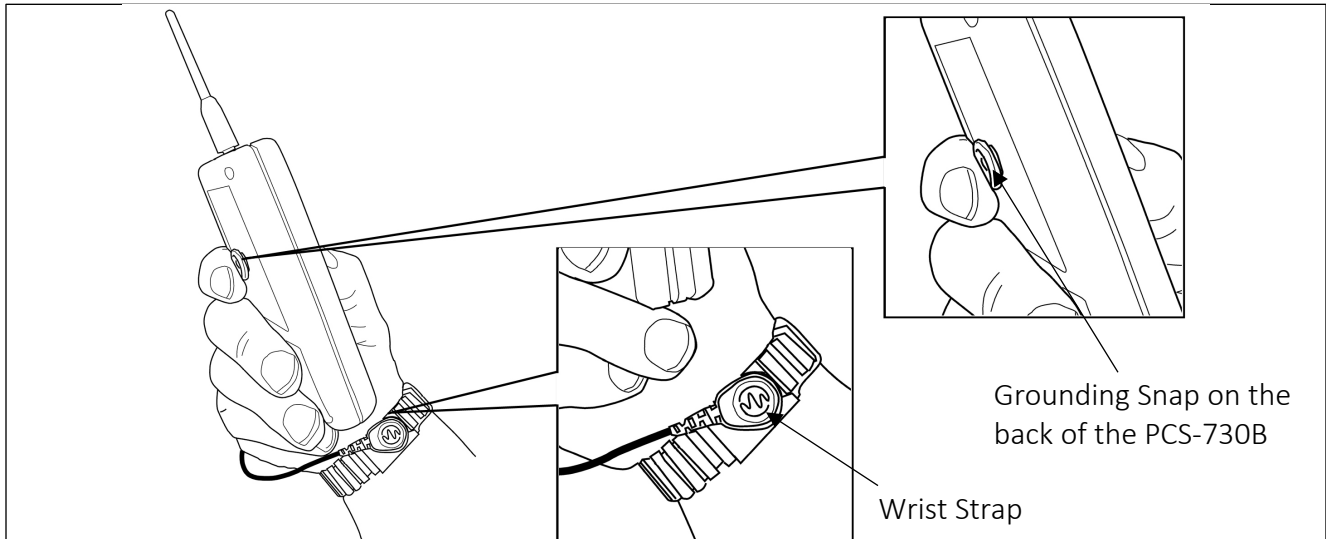

Figure 7. Operator properly grounded to use the PCS-730B

Ion Balance Measurement

The PFM-711B can easily be used to check the ion balance voltage (offset voltage) for many kind of ionizers using the CPM-720B Charge Plate Assembly.

1. Allow the ionizer to be measured to operate at normal speed for a minimum of 30 minutes prior to measuring balance. Follow the manufacturer's instructions for normal operations.
2. Mount the CPM-720B Charge Plate Assembly on the PFM-711B Field Meter Case as described above.
3. Ground the case of the PFM-711B. Note there are two ways to use Prostat devices to ground the PFM-711B/CPM-720B combination:
 - a. If the operator is wearing a properly grounded wrist strap and making direct contact with the metal ground snap mounted on the back of the PFM-711B's case, the unit will be sufficiently grounded.
 - b. Use an auxiliary worksurface common point ground snap:
 - i. Mount the 10mm male common point ground snap directly to the 10mm female snap located on the back of the PFM-711B's case.
 - ii. Attach the common point ground cord to a previously tested ground point.
4. Select the range you wish to use for balancing the ionizer.
 - a. Select the V/inch range on the PFM-711B Field Meter and zero (0) the unit, ± 2 volts to ground. This will provide the most precise balance indication and result in ± 5 volts balance.
 - b. Select the kV/inch range on the PFM-711B Field Meter and zero (0) the unit to ground. This will provide a good balance indication and result in approximately ± 15 volts balance.
5. Position the sensing surface of the CPM-720B Charge Plate perpendicular to the ionizer's air flow, approximately 12 inches from its front air outlet.
 - a. Hold the instrument combination so that the CPM-720B Charge Plate is in the airflow; minimize the airflow to the PFM-711B's meter case.
 - b. Make sure good contact is made with the PFM-711B's ground snap.



OPERATION HELPFUL HINT



Zero the PFM-711B/CPM-720B combination while grounded and the upper and lower CPM plates shorted with a small screw driver. Perform the zeroing process away from the ionizer. Hold the assembly by the PFM-711B case with your fingers touching the metal ground snap. Approach the ionized air flow from above the ionizer with the sensing CPM plate pointing down into the air stream.

6. Allow the PFM-711B/CPM-720B combination to stabilize in the ion air flow for approximately 30-45 seconds and note the ion off set voltage, i.e., the difference in voltage from the Zero set point on the PFM-711B.
7. Adjust the ion balance in accordance with the manufacturer's instructions such that the displayed off set voltage on the PFM-711B/CPM-720B combination is 0.00, ± 5 volts.
8. Remove the PFM-711B/CPM-720B combination from the ion air flow and re-zero the system. Repeat the balance measurement to insure accuracy.

Ionizer Blower Decay Performance Check

Ionizer Blower Decay Performance Check using the PFM-711B Field Meter/CPM-720A Charge Plate Assembly combination, and the PCS-730B Electrostatic Charger.

1. Allow the ionizer to operate at normal speed for a minimum of 30 minutes prior to measuring balance. Follow the manufacturer's instructions for normal operations.
2. Mount the CPM-720B Charge Plate Assembly on the PFM-711B Field Meter Case as described above.
3. Ground the case of the PFM-711B, as described below:
 - a. If the operator is wearing a properly grounded wrist strap and making direct contact with the metal ground snap mounted on the back of the PFM-711B's case, the unit will be sufficiently grounded.
 - b. Use the auxiliary work surface common point ground

- i. Mount the 10mm male common point ground snap directly to the 10 mm female snap located on the back of the PFM-711B's case.
 - ii. Attach the common point ground cord to a previously tested ground point.
4. Select the range you wish to use for auditing the ionizer's decay performance. NOTE: Most accurate decay time measurements are obtained using the analog output connected to a PGA-710B Autoanalysis System or a PDT-740B Decay Timer.
 - a. Select the **V/inch** range on the PFM-711B Field Meter and zero (0) the unit, ± 2 volts to ground. This will provide the most precise voltage indication. However, the instrument meter indication is dampened so that time of decay will be slower than actual decay time.
 - b. Select the **kV/inch** range on the PFM-711B Field Meter and zero (0) the unit to ground. This will provide good indication and result in a faster decay time because the meter dampening is less pronounced. The instrument meter indication is dampened in this range so that time of decay will be slower than actual decay time.
 - c. For accurate decay times that are documented, perform this procedure with the analog output of the PFM-711B Field Meter connected to the input of a PGA-710B Autoanalysis System. After charting the charge and decay process, calculate the actual decay time based on the chart speed of the plotter.
5. Position the sensing surface of the CPM-720B Charge Plate perpendicular to the ionizer's air flow, approximately 12 inches from its front air outlet
 - a. Hold the instrument combination so that the CPM-720B Charge Plate is in the airflow; minimize the airflow to the PFM-711B's meter case.
 - b. Make sure good contact is made with the PFM-711B's ground snap.
6. Allow the PFM-711B/CPM-720B combination to stabilize in the ion air flow for a minimum of 30-45 seconds and note the ion off set voltage.
7. Install the Charging Wand in the front of the PCS-730 Charging Source. Ground the PCS-730B Charger by making direct contact with the metal snap located on the back of its case.
 - a. To charge the wand to $>+1.0\text{kV}$ press and hold the  button switch
 - b. To charge the Wand to $>-1.0\text{kV}$, press and hold the  Negative (-) button switch

8. Touch the wand to the CPM-720B's sensing (upper) plate and note the voltage indicated on the PFM-711B.
9. Once the desired voltage level is achieved, release the button switch and remove the PCS-730B Charger from the air path.
10. Observe the voltage drop indicated on the PFM-711B meter. Voltage should decay over time to the initial off set point indicated during the balance test procedure outlined above.

Body Voltage Generation

Using the PFM-711B/CPM-720B combination to Measure Body Voltage Generation related to Footwear and Flooring combinations.

1. Mount the CPM-720B Charge Plate Assembly on the PFM-711B Field Meter Case as described above.
2. Ground the case of the PFM-711B, as described below:
 - a. Using a PWS-610M fabric wrist strap cuff, mount the cuff on one of the five (5) pound NFPA electrodes such as the PRS-801W.



NOTE

The use of the Prostat PWS-610M is recommended for this application due to its built-in 10mm male snap so that connects to the grounding female snap on the back of the PFM-711B meter.

- b. Remove the insulated cap covering the 10 mm male snap located in the cuff fabric approximately 1.5 inches from the cuff buckle.
- c. Snap mount the PFM-711B's 10 mm female snap (located on the back of the PFM-711B's case) onto the wrist strap 10 mm male snap.
- d. Adjust the wrist strap cuff so that the instrument is held firmly to the electrode; lock the adjustment buckle.
- e. Attach the wrist strap cord to the standard 4 mm snap connection located on the cuff buckle.

- f. Connect the groundable end of the wrist strap cord to a previously tested ground point.
3. Connect a wire test lead to the CPM-720B Charge Plate Assembly banana plug receptacle. One of the 800LR or 800LB ten-foot leads may be used for this purpose.
 - a. Connect the opposite end of the test lead to a metal object, such as the PFA-861H Hand-Held Electrode.
 - b. Grasp the metal handle during walking tests to “share” one’s body charge with the CPM-720B sensing plate.
 - c. Generated body voltage will be indicated on the PFM-711B Field Meter.
4. Select the range you wish to use for measuring body voltage generation.
 - a. Select the **V/inch** range on the PFM-711B Field Meter and zero the unit, ± 2 volts to ground. This will provide the slowest indication of body voltage indication due to meter dampening. Consequently, indicated voltages will be less than actual voltages generated.
 - b. Select the **kV/inch** range on the PFM-711B Field Meter and zero (0) the unit to ground. This will provide better measurements of body voltage, which is the result of less meter dampening. Again, however, indicated voltages will be less than actual voltages generated.

07 MAINTENANCE AND USER ADJUSTMENT

PFM-711B Field Meter

The PFM-711B is factory calibrated and other than battery replacement and external cleaning, general user maintenance is not required. The case has been sealed and **BREAKING THE SEALS WILL VOID THE WARRANTY.**

If for any reason you believe the meter is not working correctly, contact Prostat or an Authorized Calibration Lab for assistance.

- Clean the meter case with a dry, soft, non-scratching cloth
- DO NOT USE solution to wet the case
- Carefully wipe the case and display until dust and dirt are removed



CAUTION

In rare cases cleaning the PFM-711B case with a slightly dampened cloth may be required. Should this be required, use a very weak solution of liquid soap and water. The cloth should be barely damp. DO NOT allow cleaning solution to enter the unit through its openings.

Should the unit become damaged through the use of cleaning solutions, the warranty will be voided.

CPM-720B Charge Plate Assembly

Care should be taken when using the CPM-720B Charge Plate Assembly to avoid touching the Teflon insulators.

If necessary, the Charge Plate Assembly insulators and plates should be cleaned periodically using a clean laboratory wipe and methanol or isopropanol. Dry the assembly using gentle heat for at least 15 minutes after cleaning.

PCS-730B Electrostatic Charger

The PCS-730B is factory calibrated and other than battery replacement and external cleaning, general user maintenance is not required. The case has been sealed and BREAKING THE SEALS WILL VOID THE WARRANTY.

User adjustment is not recommended. Low output voltage is usually due to a weak battery or improper grounding. When the battery reaches 7.7 volts, the red LED will come on, which indicates a replacement is recommended, for optimal outputs.

If for any reason you believe the meter is not working correctly, contact Prostat or an Authorized Calibration Lab for assistance.

- Clean the meter case with a dry, soft, non-scratching cloth
- DO NOT USE solution to wet the case
- Carefully wipe the case and display until dust and dirt are removed

08 TROUBLESHOOTING

If your product seems to have a problem, first review this list of possible problems and solutions. If none of the troubleshooting tips apply, please visit www.prostatcorp.com and click Support or contact a Prostat Authorized Calibration Laboratory.

To keep your product in optimum condition, we recommend having it verified and calibrates on an annual basis by Prostat or an Authorized Calibration Laboratory.

The PFM-711B will not measure a surface accurately

Make sure that the sensor located at the front end of the meter has an acoustic sound coming from it:

- Turn the meter on by pressing the Power button switch once
- Hold the front end of the meter against your ear
- If you don't hear a sound coming from it, then the sensor is defective and needs to be serviced

The PFM-711B's display flashes -19.99 kV

If the PFM-711B flashes -19.99 kV, it is an indication that the sensor of the meter is defective. This could be due to the meter attempting to read a field greater than 20 kV. If the meter was dropped accidentally, the sensor may have been damaged as well, as it is a very sensitive part.

The PFM-711B is displaying erratic readings

The accuracy of the PFM-711B might be affected by the static charge on the person making the measurement if the meter is not properly grounded. For proper measurement, the operator should

be grounded using a wrist strap and making direct contact with the metal ground snap mounted on the back of the PFM-711B.

The battery may be too low. Look for the **LOBAT** indicator on the display. If it is displayed, replace the battery. If it is not display, we recommend measuring the voltage of the battery with a multimeter. If the voltage is less than 7.2 volts, replace the battery.

The PCS-730B will not output 1,000 volts

Battery voltage is too low:

The PCS-730B is designed to output $\pm 1,250$ Volts $\pm 5\%$. If the charger will not output at least 1,000 volts, the battery may be too low. We recommend measuring the voltage of the battery with a multimeter. If the voltage is less than 7.6 volts, replace the battery.

Operator must be properly grounded:

For correct output, the operator should be grounded using a wrist strap and making direct contact with the metal ground snap mounted on the back of the PCS-730B.

Internal wire damaged:

The internal wire connecting the red receptacle to the circuit board may be broken. When inserting the charging wand into the red receptacle, simply push the rod in. The rod is not designed to be screwed in. **DO NOT ROTATE THE RED RECEPTACLE AS IT MAY DAMAGE OR BREAK A WIRE.**

The CPM-720B will not retain a charge long enough

Per ANSI/ESD STM3.1, the isolated conductive plate, when charged to the desired test voltage, shall not discharge more than 10% of the test voltage.

If the CPM-720B is losing more than 10% of the charge within 1 minute, you may need to clean the Teflon insulators. You may also need to disassemble the charge plate to clean the Teflon insulators.

Use a clean laboratory wipe and methanol or isopropanol to clean the insulators and plates.



QUESTIONS OR COMMENTS?

CALL	OR VISIT US ONLINE AT	WRITE
1-855-STATIC1 (782-8421)	www.prostatcorp.com/contact-us	Prostat Corporation 399 Wall Street, Suite G Glendale Heights, IL 60139

©2021 Prostat Corporation. All rights reserved.

Prostat, Prostat Corporation and the Prostat logo are trademarks or registered trademarks of Prostat Corporation or one of its affiliated companies in the United States and/or other countries. All other trademarks or registered trademarks are the property of their respective owners. Complying with all applicable copyright laws is the responsibility of the user. Modification of this document is not permitted without written permission from Prostat Corporation.

Content subject to change without notice. Printed in U.S.A.
Rev 5: 10/9/2023